

## SISTEMA MODULAR AÉREO PARA TUBO Ø19mm / OVERHEAD MODULAR SYSTEM FOR Ø19mm TUBE / SISTEMA MODULAR AÉREO PARA TUBO Ø19MM /

### SM.010.A.19.3000

Tubo Ø19 com 3000mm /  
 Tube Ø19 with 3000mm /  
 Tubo Ø19 con 3000mm.

**Material:** EN 1.4301 / AISI 304  
**Acabamento / Finish / Acabado:**  
 satinado / satin

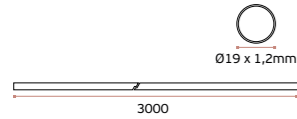

### SM.010.A.19.2000

Tubo Ø19 com 2000mm /  
 Tube Ø19 with 2000mm /  
 Tubo Ø19 con 2000mm.

**Material:** EN 1.4301 / AISI 304  
**Acabamento / Finish / Acabado:**  
 satinado / satin  
**Opcional / Optional:**  
 pvd titanium black (.TB); gold (.TG) /  
 copper (.TCO); / natural (.TN)

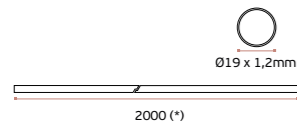

1. SM.010.A.19.2000.TB 2. SM.010.A.19.2000.TG 3. SM.010.A.19.2000.TCO

### SM.010.A.19.1000.TN

Tubo Ø19 com 1000mm /  
 Tube Ø19 with 1000mm /  
 Tubo Ø19 con 1000mm.

**Material:** EN 1.4301 / AISI 304  
**Acabamento / Finish / Acabado:**  
 satinado / satin  
**Opcional / Optional:**  
 pvd titanium natural (.TN)

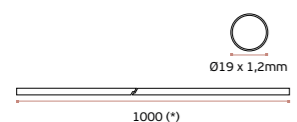

### SM.010.C.19

Conector para tubo Ø19mm /  
 Tube connector Ø19mm /  
 Conector de tubo Ø19mm.

**Material:** alumínio / aluminium  
**Acabamento / Finish / Acabado:**  
 satinado / satin

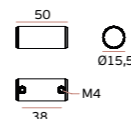

### SM.011.19

Suporte de tubo com fixação à  
 parede / Wall mounting tube  
 support / Soporte de tubo con  
 sujeción a pared.

**Material:** EN 1.4301 / AISI 304  
**Acabamento / Finish / Acabado:**  
 satinado / satin  
**Opcional / Optional:**  
 pvd titanium black (.TB); gold (.TG) /  
 copper (.TCO); / natural (.TN)



1. SM.011.19.TB 2. SM.011.19.TG  
 3. SM.011.19.TCO 4. SM.011.19.TN

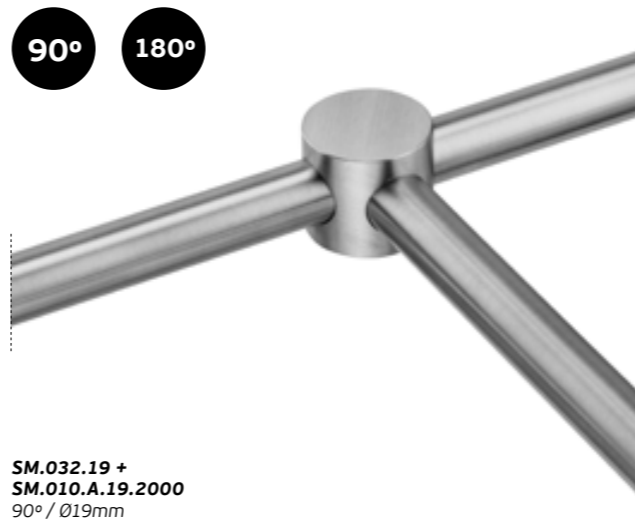

SM.032.19 +  
 SM.010.A.19.2000  
 90° / Ø19mm

### SM.033.19

União de tubo a 90° e 180° para  
 tubo de Ø19mm / Tube connector  
 at 90° and 180° for Ø19mm / Union  
 de tubo a 90° y 180° para tubo de  
 Ø19mm.

**Material:** EN 1.4301 / AISI 304  
**Acabamento / Finish / Acabado:**  
 satinado / satin  
**Opcional / Optional:**  
 pvd titanium black (.TB); gold (.TG) /  
 copper (.TCO); / natural (.TN)

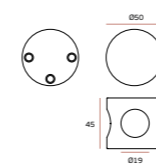

1. SM.033.19.TB 2. SM.033.19.TG  
 3. SM.033.19.TCO 4. SM.033.19.TN



SM.033.19 +  
 SM.010.A.19.2000  
 90° + 180° / Ø19mm

### SM.032.19

União de tubo a 90° para tubo  
 Ø19mm / Tube connector at 90° for  
 Ø19mm tube / Union de tubo a 90°  
 para tubo de Ø19mm.

**Material:** EN 1.4301 / AISI 304  
**Acabamento / Finish / Acabado:**  
 satinado / satin  
**Opcional / Optional:**  
 pvd titanium black (.TB); gold (.TG) /  
 copper (.TCO); / natural (.TN)

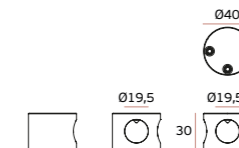

1. SM.032.19.TB 2. SM.032.19.TG  
 3. SM.032.19.TCO 4. SM.032.19.TN

