



ARCHITECTURAL
HARDWARE



JNF PORTUGAL

Head office / Factory

Comércio e Indústria de Ferragens S.A.
Rua Mimosas 849 / 851,
Zona Industrial Mimosas
4510-329 S. Pedro da Cova,
Portugal

Tel: +351 224 663 230

jnf@jnf.pt

www.jnf.pt

JNF SPAIN

Office / Showroom

JNFmyStore
Carrer Bruc, 77 Local dch.
08009 Barcelona

Tel: +34 932 504 047

Fax: +34 934 674 500

jnf@jnfmystore.es

www.jnfmystore.es

Vol.3
2nd version
2^a versão / 2^a versión

CT-22.13.1

JNF © 2024- 2025

**ALWAYS
MORE**

59 YEARS
1965.2024



reddot winner 2022



ARCHITECTURAL
HARDWARE

A EMPRESA JNF THE JNF COMPANY / LA EMPRESA JNF

UMA EQUIPA DE CONFIANÇA COM HISTÓRIA

Desde 1965, a nossa principal atividade passa pela produção de ferragens para mobiliário e construção, com um percurso de contínua evolução e adaptação à economia e aos desafios do mercado, dedicando especial atenção ao desenvolvimento de soluções que vão ao encontro das tendências da arquitetura contemporânea.

Foram criados vários sectores dentro da JNF, nomeadamente a investigação e desenvolvimento de produtos que desempenham um papel fundamental na dinâmica da empresa. Temos também colaborações com organizações que nos fornecem informação e orientação no desenvolvimento de projetos, alguns deles ligados a universidades portuguesas nas áreas da engenharia e design.

O nosso departamento de Design é multidisciplinar e concilia elementos de diversas especialidades, como industrial, produto, gráfico, comunicação e marketing. Uma equipa dinâmica, que procura criar soluções inovadoras de forma clara e adequada, reafirmando sempre a identidade da empresa e o seu posicionamento no mercado.

As nossas instalações têm uma área coberta aproximada a 9000m², estando divididas em duas zonas principais: a produção e a logística. Empregamos diretamente cerca de 50 pessoas e indiretamente quase 150, através de subcontratação que utilizamos de forma cuidada, com um rigoroso controlo de qualidade, de acordo com a NP EN ISO 9001:2008.

Somos muito ativos na observação das tendências do mercado internacional, mesmo em áreas diferentes, tendo permanentemente em desenvolvimento uma quantidade considerável de novos projetos.

O nosso Programa de Sustentabilidade visa contribuir para a redução da pegada ecológica e desperdícios. Nesse sentido, para além da utilização do aço inox, também utilizamos acabamentos especiais não galvânicos e não poluentes, como é o caso do acabamento em titânio conseguido através da tecnologia PVD (Physical Vapor Deposition).

Como resultado desta procura constante por novos designs e processos, temos sido contemplados com o reconhecimento de empresa inovadora e sustentável.

O nosso compromisso com os clientes passa por garantir uma prestação de serviço e assistência de qualidade, fazendo tudo o que está ao nosso alcance para que fique 100% satisfeito.

A RELIABLE TEAM WITH A HISTORY

Since 1965, our main activity has been the production of hardware for furniture and construction, with a path of continuous evolution and adaptation to the economy and the challenges of the market, devoting special attention to the development of solutions that meet the trends of contemporary architecture.

Several sectors have been created within the JNF, namely research and development of products that play a fundamental role in the company's dynamics. We also have collaborations with organizations that provide us with information and guidance in the development of projects, some of them linked to Portuguese universities in the areas of engineering and design.

Our Design department is multidisciplinary and combines elements from different specialties, such as industrial, product, graphics, communication and marketing. A dynamic team that seeks to create innovative solutions in a clear and appropriate way, always reaffirming the company's identity and its positioning in the market.

Our facilities have a covered area of approximately 9000m², being divided into two main areas: production and logistics. We employ around 50 people directly and almost 150 indirectly, through subcontracting that we use carefully, with strict quality control, in accordance with NP EN ISO 9001: 2008.

We are very active in observing the trends of the international market, even in different areas, having a considerable number of new projects permanently under development.

Our Sustainability Program aims to contribute to reducing the ecological footprint and waste. In this sense, in addition to the use of stainless steel, we also use special non-galvanic and non-polluting finishes, such as the titanium finish achieved through PVD (Physical Vapor Deposition) technology.

As a result of this constant search for new designs and processes, we have been recognized with an innovative and sustainable company.

Our commitment to customers is to guarantee the provision of quality service and assistance, doing everything in our power to make you 100% satisfied.

UN EQUIPO CONFIABLE CON HISTORIA

Desde 1965 nuestra principal actividad ha sido la producción de ferretería para mobiliario y construcción, con un camino de continua evolución y adaptación a la economía y los retos del mercado, dedicando especial atención al desarrollo de soluciones que respondan a las tendencias de la arquitectura contemporánea.

Se han creado varios sectores dentro de JNF, a saber, investigación y desarrollo de productos que juegan un papel fundamental en la dinámica de la empresa. También tenemos colaboraciones con organizaciones que nos brindan información y orientación en el desarrollo de proyectos, algunos de ellos vinculados a universidades portuguesas en las áreas de ingeniería y diseño.

Nuestro departamento de Diseño es multidisciplinar y combina elementos de diferentes especialidades, como industrial, producto, gráfica, comunicación y marketing. Un equipo dinámico que busca crear soluciones innovadoras de forma clara y adecuada, reafirmando siempre la identidad de la empresa y su posicionamiento en el mercado.

Nuestras instalaciones cuentan con una superficie cubierta de aproximadamente 9000m², estando divididas en dos áreas principales, producción y logística. Empleamos alrededor de 50 personas de forma directa y casi 150 de forma indirecta, mediante subcontratación que utilizamos con cuidado, con un estricto control de calidad, de acuerdo con NP EN ISO 9001: 2008.

Somos muy activos en la observación de las tendencias del mercado internacional, incluso en diferentes áreas, teniendo un número considerable de nuevos proyectos en permanente desarrollo.

Nuestro Programa de Sustentabilidad tiene como objetivo contribuir a la reducción de la huella ecológica y desperdicio. En este sentido, además del uso de acero inoxidable, también utilizamos acabados especiales no galvânicos y no contaminantes, como el acabado de titanio logrado mediante la tecnología PVD (Physical Vapor Deposition).

Fruto de esta búsqueda constante de nuevos diseños y procesos, hemos sido reconocidos con una empresa innovadora y sostenible.

Nuestro compromiso con los clientes es garantizar la prestación de un servicio y asistencia de calidad, haciendo todo lo que esté a nuestro alcance para que esté 100% satisfecho.



A EMPRESA JNF THE JNF COMPANY / LA EMPRESA JNF

A NOSSA MISSÃO

Garantir a produção e distribuição de ferragens para construção e mobiliário que solucionam a maior parte das exigências dos projetos de arquitetura contemporânea e de reabilitação, com especial atenção à satisfação dos nossos clientes.

A NOSSA VISÃO

Ser uma referência nacional e internacional no setor onde exercemos atividade, apostando na tecnologia, inovação, funcionalidade e design, aliados à responsabilidade Ambiental e Social.

OS NOSSOS VALORES

Reconhecendo que a construção de uma identidade e cultura empresarial fortes são determinantes para a concretização dos desafios a que a JNF se propõe, mantemos os padrões de qualidade elevada nos nossos produtos e serviços de apoio ao cliente.

OUR MISSION

Ensure the production and distribution of construction and furniture hardware that solve most of the requirements of contemporary architecture and rehabilitation projects, with special attention to the satisfaction of our customers.

OUR VISION

To be a national and international reference in the sector where we operate, betting on technology, innovation, functionality and design, combined with Environmental and Social responsibility.

OUR VALUES

Recognizing that the construction of a strong corporate culture and identity are crucial for the realization of the challenges that JNF proposes, we maintain high quality standards in our products and customer support services.

NUESTRA MISIÓN

Asegurar la producción y distribución de herrajes de construcción y mobiliario que resuelvan la mayoría de los requerimientos de los proyectos de arquitectura y rehabilitación contemporánea, con especial atención a la satisfacción de nuestros clientes.

NUESTRA VISIÓN

Ser un referente nacional e internacional en el sector donde operamos, apostando por la tecnología, la innovación, la funcionalidad y el diseño, combinado con la responsabilidad ambiental y social.

NUESTROS VALORES

Reconociendo que la construcción de una sólida cultura e identidad corporativa es crucial para la realización de los desafíos que propone JNF, mantenemos altos estándares de calidad en nuestros productos y servicios de atención al cliente.



JNF EM HARMONIA COM A NATUREZA

Num planeta constantemente exposto a agressões ambientais, na JNF trabalha-se diariamente no sentido de diminuir a “pegada ecológica” dos nossos processos.

No desenvolvimento dos nossos produtos temos especial atenção para com os processos de fabrico, bem como tudo o que os envolve. O aço inox é reciclável e muita da nossa matéria-prima provém da reciclagem.

Os tratamentos de superfície são totalmente mecânicos ou utilizando tecnologias sem processos químicos. O acabamento de titânio é obtido por processos físicos.

As nossas preocupações surgem desde que idealizamos um produto até à forma como o embalamos, para que o ciclo de vida deste tenha o menor impacto ambiental possível. Temos como objetivo a eliminação do plástico de uso único nas nossas embalagens. Utilizaremos apenas materiais 100% recicláveis.

Hoje, mais do que nunca, para além de conhecer o produto final, é essencial ter em consideração os meios utilizados para o alcançar.

JNF IN HARMONY WITH NATURE

On a planet constantly exposed to environmental aggressions, JNF works daily to reduce the “ecological footprint” of our processes.

In the development of our products we pay special attention to the manufacturing processes, as well as everything that involves them. Stainless steel is recyclable and much of our raw material comes from recycling.

The surface treatments are entirely mechanical or using technologies without chemical processes. Titanium finish is achieved by physical processes.

Our concerns arise from the idea of a product to the way we pack it, so that its life cycle has the least possible environmental impact. We aim to eliminate single-use plastic in our packaging. We will only use 100% recyclable materials.

Today, more than ever, in addition to knowing the final product, it is essential to take into account the means used to achieve it.

JNF EN ARMONÍA CON LA NATURALEZA

En un planeta constantemente expuesto a agresiones medioambientales, en el JNF trabajamos a diario para reducir la “huella ecológica” de nuestros procesos.

En el desarrollo de nuestros productos prestamos especial atención a los procesos de fabricación, así como a todo lo que los envuelve. El acero inoxidable es reciclable y gran parte de nuestra materia prima procede del reciclaje.

Los tratamientos superficiales son totalmente mecánicos o utilizan tecnologías no químicas. Lo acabado de titanio se obtiene mediante procesos físicos.

Desde el momento en que diseñamos un producto hasta la forma en que lo envasamos, nos preocupa que el ciclo de vida del producto tenga el menor impacto medioambiental posible. Nuestro objetivo es eliminar el plástico de un solo uso de nuestros envases. Sólo utilizaremos materiales 100% reciclables.

Hoy, más que nunca, además de conocer el producto final, es imprescindible tener en cuenta los medios utilizados para conseguirlo.



ALWAYS MORE
GREEN SOLUTIONS



SISTEMA DE GESTÃO DE QUALIDADE
QUALITY MANAGEMENT SYSTEM
SISTEMA DE GESTIÓN DE CALIDAD.

NP EN ISO 9001:2015



SISTEMA DE GESTÃO AMBIENTAL
ENVIRONMENTAL MANAGEMENT SYSTEM
SISTEMA DE GESTIÓN AMBIENTAL

NP EN ISO 14001:2015



SISTEMA DE GESTÃO DA SEGURANÇA E SAÚDE NO TRABALHO
SAFETY MANAGEMENT SYSTEM AND HEALTH AT WORK
SISTEMA DE GESTIÓN DE LA SEGURIDAD Y SALUD EN EL TRABAJO

ISO 45001:2018

MATERIAIS E ACABAMENTOS / MATERIALS AND FINISHES / MATERIALES Y ACABADOS /



**ALWAYS
MORE
GREEN
SOLUTIONS**

OS PRIMEIROS AÇOS INOXIDÁVEIS FORAM DESENVOLVIDOS PELA INDÚSTRIA SIDERÚRGICA ALEMÃ NO INÍCIO DO SÉCULO XX.

O TERMO GENÉRICO DE “AÇO INOX” ENVOLVE MUITOS TIPOS DE LIGAS DE AÇO COM ELEVADA RESISTÊNCIA À CORROSÃO, QUE SURTIRAM COMO RESPOSTA ÀS SOLICITAÇÕES DA INDÚSTRIA.

O aço inoxidável é reciclável e resulta ele mesmo em grande parte da reciclagem de sucatas. Uma das grandes vantagens da utilização de aços inoxidáveis, é não requerer tratamento superficial galvânico para lhe conferir o acabamento final.

Desta forma todos os processos industriais químicos, quase sempre poluentes, associados à galvanoplastia foram suprimidos, conseguindo-se acabamentos de muita qualidade em tudo idênticos ao cromado, no caso de aço polido, ou acabamentos mate, no caso de aço satinado ou areado ou acabamento industrial “RAW”.

Existe ainda a possibilidade de realizar acabamentos especiais sobre o aço inoxidável, recorrendo a tecnologia PVD (Physical Vapor Deposition), obtendo-se produtos com maior dureza superficial e com cores diferentes do aço, como é o caso do dourado ou negro.

Normalmente o aço inox é “reparável” por processos mecânicos ou químicos, conseguindo-se recuperar o aspecto duma peça nova mesmo após muitos anos de uso.

Os aços inoxidáveis são uma liga metálica que contém, entre outros elementos, cromo, níquel e molibdénio os quais conferem grande resistência à corrosão. A resistência à corrosão deve-se sobretudo ao cromo.

Para um aço ser considerado “inoxidável”, deve conter no mínimo 10,5% de Crómio. A resistência à corrosão deve-se a uma película de óxido de crómio formada na superfície do aço que funciona como auto-protectora. O processo de formação desta “película” também é conhecido por passivação.

O níquel altera basicamente as características mecânicas do aço em termos de dureza com o objectivo de melhorar a sua mecanização.

THE FIRST STAINLESS STEELS HAVE BEEN DEVELOPED BY THE GERMAN INDUSTRY IN THE EARLY 20TH CENTURY.

THE GENERIC TERM “STAINLESS STEEL” INVOLVES MANY TYPES OF STEEL ALLOY WITH HIGH CORROSION RESISTANCE, WHICH EMERGED AS RESPONSE TO INDUSTRY REQUESTS.

Stainless steel is recyclable and itself results largely from recycled steel scrap. One of the great advantages of using stainless steel is that it does not require galvanic surface treatment to give the final finish to the product.

In this way all industrial chemical processes, almost pollutant, mainly by galvanic way have been removed. It's possible to reach high quality finishes identical to the chrome plated in the case of polished steel or matte finishes in the case of satin finish or sand finish or even industrial “RAW” finish.

It is also possible to carry out special finishes on stainless steel, using the PVD technology (Physical Vapor Deposition), obtaining products with a higher surface hardness and different steel color, as is the case of gold or black color satin.

Typically, stainless steel is “recoverable” by mechanical or chemical process. It's possible to recover the appearance of a new product after many years of use.

Stainless steel is an alloy that contains, among other elements, chromium, nickel and molybdenum, which confer high resistance to corrosion. The corrosion resistance is mainly due to the chromium.

To be considered a “stainless” steel, it must contain at least 10.5% chromium. The corrosion resistance is due to a Chromium oxide layer, formed on the steel surface which acts as self-protective. The formation process of this layer is also known as passivation.

Nickel essentially alters the mechanical characteristics of the steel in terms of hardness, in order to improve the machining process.

LOS PRIMEROS ACEROS INOXIDABLES HAN SIDO DESARROLLADOS EN ALEMANIA EN INICIO DEL SIGLO XX.

EL TÉRMINO GENÉRICO DE “ACERO INOXIDABLE” IMPLICA MUCHOS TIPOS DE ALEACIONES DE ACERO DE ALTA RESISTENCIA A LA CORROSIÓN, QUE SURTIÓ EN RESPUESTA A LAS PETICIONES DE LA INDUSTRIA.

El acero inoxidable es reciclable y resulta en gran medida a partir del reciclaje de chatarra de acero. Una de las grandes ventajas de la utilización de acero inoxidable es que no requiere tratamiento superficial de galvanizado para darle el acabado final.

De esta forma, se han eliminado todos los procesos industriales químicos, casi siempre contaminantes, asociados a la galvanoplastia, consiguiendo acabados de gran calidad, idénticos al cromado, en el caso del acero pulido, o mates, en el caso del satinado o acero arenado o industrial “RAW”.

También es posible llevar a cabo acabados especiales en acero inoxidable, utilizando la tecnología de PVD (Physical Vapor Deposition), con obtención de productos con una dureza superficial superior y color diferente del acero como es el caso del oro o negro.

El acero inoxidable normalmente es “reparable” por proceso mecánico o químico. Es posible recuperar la apariencia de una pieza nueva después de muchos años de uso.

El acero inoxidable es una aleación que contiene, entre otros elementos, cromo, níquel y molibdeno que confieren alta resistencia a la corrosión. La resistencia a la corrosión se debe principalmente al cromo.

Para ser considerado un acero “inoxidable”, debe contener al menos 10,5% de Cromo. La resistencia a la corrosión es debida a una película de óxido de cromo formada en la superficie de acero que actúa como auto-protectión. El proceso de formación de esta “película” es también conocido como pasivación.

El níquel esencialmente altera las características mecánicas del acero en términos de dureza con el fin de mejorar el mecanizado.

MATERIAIS E ACABAMENTOS / MATERIALS AND FINISHES / MATERIALES Y ACABADOS /

OS QUATRO PRINCIPAIS TIPOS DE AÇO INOX: AUSTENITICOS (CROMO-NIQUEL E CROMO-NIQUEL-MOLIBDÊNIO); FERRITICOS; DUPLEX; MARTENSITICOS

Os tipos de aço utilizados por JNF:

EN 1.4301 (AISI 304): Austenítico

É um dos aços inoxidáveis de uso mais generalizado na construção e indústria. Aço não magnético ainda que se possa converter em ligeiramente magnético no caso de ser maquinado. Possui uma excelente característica de dureza e resistência à corrosão. Teor mínimo de cromo é de 18% e de níquel 8%.

EN 1.4401 (AISI 316): Austenítico

É ligeiramente mais resistente à corrosão comparativamente ao AISI 304. Aço não magnético ainda que se possa converter em ligeiramente magnético no caso de ser maquinado. Recomendado para zonas de elevada salinidade, por exemplo em zonas costeiras ou em ambientes muito poluídos, ou em contacto com produtos químicos agressivos, ácidos e bases. Possui teor mínimo de cromo 18% e níquel 10%, 2% de molibdénio.

EN 1.4372 (AISI 201): Austenítico

É um aço inoxidável com baixo teor de níquel, sendo por isso de elevada dureza. Resistência à corrosão é aceitável na maioria das aplicações, excepto nas zonas costeiras ou fortemente poluídas. Aço não magnético ainda que se possa converter em ligeiramente magnético no caso de ser maquinado. Possui teor mínimo de cromo 17%, níquel 3,6%, manganésio 7%.

EN 1.4016 (AISI 430): Ferrítico

Aço inoxidável de uso geral na indústria alimentar. Utilizado normalmente em atmosferas não agressivas. Aço magnético, com aceitável resistência à corrosão. Acabamento superficial de elevada qualidade.

THE FOUR MAIN TYPES OF STAINLESS STEEL: AUSTENITIC (CHROMIUM-NICKEL & CHROME-NICKEL-MOLYBDENUM); FERRITIC; DUPLEX; MARTENSITIC.

The steel grades used by JNF :

EN 1.4301 (AISI 304): Austenitic

It's one of the most widely used stainless steels in construction and industry. Non-magnetic steel which can be slightly magnetic converted if machined. It has an excellent hardness and corrosion resistance. Minimum contents of chromium is 18% and 8% nickel.

EN 1.4401 (AISI 316): Austenitic

It is slightly more resistant to corrosion, when compared with AISI 304. Non-magnetic steel which can be slightly magnetic converted if machined. Recommended for areas of high salinity, for example in coastal areas, very polluted places or in contact with aggressive chemicals, as acids and bases. Has a minimum content of chromium 18%, nickel 10% and 2% molybdenum.

EN 1.4372 (AISI 201): Austenitic

Stainless steel with low nickel contents and is therefore a high hardness steel. Corrosion resistance is acceptable for almost applications, except in coastal areas or heavily polluted. Non-magnetic steel which can be slightly magnetic converted if machined. It has minimum content of 17% chromium, nickel 3,6%, 7% manganese.

EN 1.4016 (AISI 430): Ferritic

Stainless steel commonly used in food industry. Typically used in non-aggressive atmospheres. Magnetic steel with an acceptable corrosion resistance. High quality surface finish.

LOS CUATRO TIPOS PRINCIPALES DE ACERO INOXIDABLE: AUSTENÍTICO (CROMO-NÍQUEL Y CROMO-NÍQUEL-MOLIBDENO); FERRÍTICO; DUPLEX; MARTENSÍTICO.

Los tipos de acero utilizados por JNF:

EN 1.4301 (AISI 304): Austenítico

Es uno de los aceros inoxidables más ampliamente utilizados en la construcción y la industria. Acero no magnético que puede convertirse en ligeramente magnético después de mecanizar. Tiene una excelente resistencia a la corrosión y dureza. El contenido mínimo de cromo es de 18% y el 8% de níquel.

EN 1.4401 (AISI 316): Austenítico

Es ligeramente más resistentes a la corrosión en comparación con AISI 304. Acero no magnético que puede convertirse ligeramente magnético después de mecanizar. Tiene un contenido mínimo de cromo 18%, 10% níquel y 2% de molibdeno.

EN 1.4372 (AISI 201): Austenítico

Acero inoxidable de bajo contenido de níquel y por tanto es de gran dureza. Resistencia a la corrosión es aceptable para la mayoría de las aplicaciones, excepto en las zonas costeras o muy contaminadas. Acero no magnético que pueden convertirse ligeramente magnético después de mecanizar. Tiene contenido mínimo de 17% de cromo, níquel 3,6% y 7% de manganeso.

EN 1.4016 (AISI 430): Ferrítico

Acero inoxidable comúnmente usado en la industria alimentaria. Se utiliza típicamente en ambientes no agresivos. Acero magnético con una resistencia a la corrosión aceptable. Acabado superficial de alta calidad.

EN	AISI	C max.	Mn max.	Si max.	S max.	P max.	Cr	Ni	Mo
EN.1.4301	AISI 304	0,07	2,00	1,00	0,030	0,045	17 - 19,5	8 - 10,5	0
EN.1.4401	AISI 316	0,07	2,00	1,00	0,030	0,045	16,5 - 18,5	10 - 13	2,0 - 2,5
EN.1.4016	AISI 430	0,08	1,00	1,00	0,030	0,040	16 - 18	0	0



TESTE REAL DE RESISTÊNCIA À CORROSÃO

REAL TEST OF CORROSION RESISTANCE

TESTE REAL DE RESISTÊNCIA A LA CORROSIÓN

O teste foi realizado de acordo com as condições de ensaio NP EN ISO 9227:2011, método de ensaio e classificação de acordo com a norma NP EN 1670:2011 com 480h de nevoeiro salino numa solução de cloreto de sódio a 5%.

The test was performed according to test conditions NP EN ISO 9227:2011, method for testing and sorting according to standard EN 1670:2011 with 480h salt spray from a solution of sodium chloride to 5%.

Lo teste foi elaborado de acordo com las condições de prueba NP EN ISO 9227:2011, método de ensayo y clasificación de acuerdo con la norma NP EN 1670:2011 con 480h de niebla salina de una solución de cloruro de sodio al 5%.

RESULTADO FINAL APÓS 480 HORAS DE NEVOEIRO SALINO.

RESULT AFTER 480 HOURS OF SALT SPRAY TEST.

RESULTADO FINAL DECURRIDAS 480 HORAS DE NIEBLA SALINA.

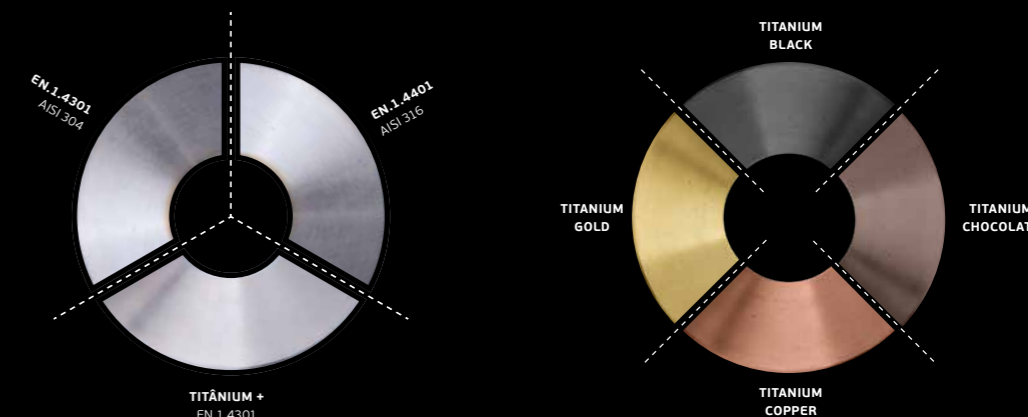

EN.1.4301
AISI 304



EN.1.4401
AISI 316



TITANIUM +
EN.1.4301



TITANIUM
GOLD

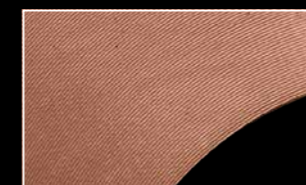

TITANIUM
COPPER



TITANIUM
CHOCOLATE

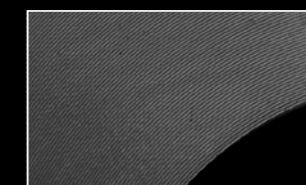

TITANIUM
BLACK

Tipo de aço / Steel grade / Tipo de acero	Área com ferrugem / Rusty surface / Superficie com oxidación % Após / After /Decurridas 96h	Área com ferrugem / Rusty surface / Superficie com oxidación % Após / After /Decurridas 120h	Área com ferrugem / Rusty surface / Superficie com oxidación % Após / After /Decurridas 240h	Área com ferrugem / Rusty surface / Superficie com oxidación % Após / After /Decurridas 480h	Classe / Class
EN.1.4301	0	0	< 1		3
EN.1.4401	0	0	< 0,5		4
EN.1.4301 + Titanium	0	0	0		4

ACABAMENTOS MECÂNICOS / MECHANICAL FINISHES / ACABADOS MECÁNICOS.



ÇO INOXIDÁVEL SATINADO OU ESCOVADO SATIN OR BRUSHED STAINLESS STEEL / ACERO INOX SATINADO O CEPILLADO.

SATINADO

ESTE É O NOSSO ACABAMENTO PADRÃO

O aço é polido de forma a conseguir um acabamento "mate" sem brilho. O nosso acabamento mate é obtido com materiais de alta qualidade, conseguindo-se superfícies de muito baixa rugosidade mas que, no entanto, continuam sem brilho, funcionando como peças "neutras" reflectindo de forma ténue os tons envolventes. Todas as nossas peças estão disponíveis neste acabamento.

SATIN

THIS IS OUR STANDARD FINISH

The steel is polished to achieve a matte finish with no shining. Our matte finish is obtained with high quality materials, achieving a very low surface roughness but which, however, remain non-glossy, functioning as neutral pieces, reflecting tenuously the surrounding tones. All our products are available with this finish.

SATIN

ESTE ACABADO ES NUESTRO STANDARD

El acero es pulido con el fin de conseguir un acabado mate sin brillo. El acabado mate se logra con materiales de alta calidad, la rugosidad superficial es muy baja pero, sin embargo, siguen siendo de color mate, las piezas funcionan como neutras que reflejan de forma tenue los tonos que le rodean. Todas nuestras piezas están disponibles en el acabado.



.S
Aço inoxidável satinado ou escovado /
Satin or brushed stainless steel /
Acero inox satinado o cepillado.

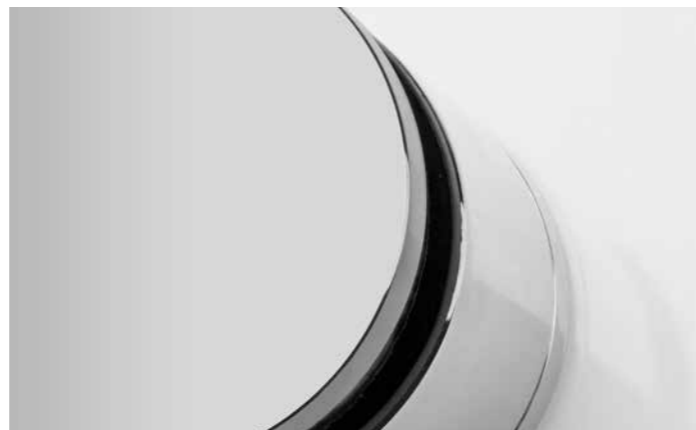

ÇO INOXIDÁVEL POLIDO BRILHO / MIRROR POLISHED STAINLESS STEEL / ACERO INOX PULIDO BRILLO.

POLIDO

ACABAMENTO ESPECIAL PARA AÇO INOX

Este acabamento resulta do polimento do aço até à obtenção de superfícies completamente lisas e brilhantes. É um acabamento semelhante ao cromado brilhante. As peças reflectem de forma brilhante os tons envolventes. Algumas das nossas peças estão disponíveis neste acabamento. De uma forma geral, salvo algumas excepções, todas as peças podem ser fabricadas neste acabamento. Existem limitações quanto ao tamanho das peças que podem ser polidas.

MIRROR POLISHED

SPECIAL FINISH ON STAINLESS STEEL

This finish results from the polishing of the steel until obtaining completely smooth and shiny surfaces. It's similar to a bright chrome finish. The pieces reflect shining surrounding tones. Some of our pieces are available at this finish. Generally, with few exceptions, all fittings can be manufactured in this finishing. There are limitations on the size of parts that can be mirror polished.

PULIDO BRILLO

ACABADOS ESPECIALES EN ACERO INOXIDABLE

Este acabado resulta del pulimento del acero hasta la obtención de superficies completamente lisas con brillo. Es un acabado semejante al cromo brillo. Las piezas reflejan de forma brillante los tonos envolventes. Algunas de nuestras piezas están disponibles en este acabado. De una forma general, salvo algunas excepciones, todas las piezas pueden ser fabricadas en este acabado. Hay limitaciones en el tamaño de las piezas que pueden ser pulidas.

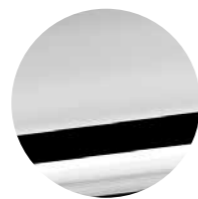

.P
Aço inoxidável polido brilho /
Mirror polished stainless steel /
Acero inox pulido brillo.

STAINLESS STEEL > MATERIAL

AÇO INOXIDÁVEL + ACABAMENTOS ESPECIAIS / ACERO INOX + ACABADOS ESPECIALES



ÇO INOXIDÁVEL ACABAMENTO INDUSTRIAL "RAW" / INDUSTRIAL "RAW" STAINLESS STEEL / ACERO INOX ACABADO INDUSTRIAL "RAW"

RAW

ACABAMENTO ESPECIAL PARA AÇO INOX

Este acabamento é conseguido na fase final do processo de polimento. As peças são submetidas a um tratamento de abrasão. O resultado final são peças absolutamente sem brilho com uma textura muito agradável ao tacto. Visualmente as peças apresentam uma coloração cinza, parecida com betão, dando uma imagem de peças industriais, como se fossem ferramentas. Todas as nossas peças podem ser fabricadas com este acabamento, existe, contudo, uma limitação quanto ao comprimento máximo de 600mm.

RAW

SPECIAL FINISH ON STAINLESS STEEL

This finish is achieved in the final phase of the polishing process. The parts are subjected to a treatment of abrasion. The end result is absolutely dull pieces with a very nice texture to be touched. Visually, the pieces have a grey concrete like color, giving the image of industrial parts, like they were tools. All our parts can be manufactured in this finish, however there is a limit on the maximum length of 600 mm.

RAW

ACABADOS ESPECIALES EN ACERO INOXIDABLE

Este acabado se consigue en la fase final del proceso de pulido. Las partes se someten a un tratamiento de abrasión. El resultado final es de piezas absolutamente sin brillo, con una textura muy agradable al tacto. Visualmente las piezas tienen un color gris, al igual que lo concreto, dando a las piezas una imagen industrial como si fueran herramientas. Todas nuestras piezas pueden ser fabricadas en este acabado, sin embargo hay un límite en la longitud máxima de 600mm.

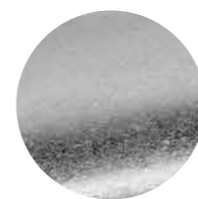

.RAW
Aço inoxidável acabamento industrial "raw" /
Industrial "raw" stainless steel /
Acero inox acabado industrial "raw"

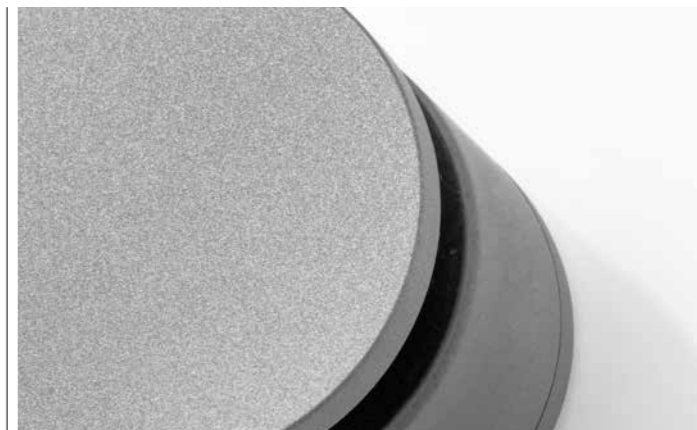

ÇO INOXIDÁVEL ACABAMENTO JET STAINLESS STEEL JET FINISH / ACERO INOX ACABADO JET /

JET

ACABAMENTO ESPECIAL PARA AÇO INOX

Este acabamento é conseguido na fase final do processo de polimento. As peças são submetidas a um tratamento de projeção de partículas de vidro. O resultado final são peças de cor cinza mate uniforme, com uma textura agradável ao tacto. Visualmente, as peças apresentam uma coloração discreta perfeitamente adequada a ambientes onde não se pretendem brilhos metálicos. As peças resultantes são completamente discretas e integram-se em qualquer tipo de decoração. Todas as nossas peças podem ser fabricadas com este acabamento, existe contudo uma limitação quanto ao comprimento máximo de 600mm.

JET

SPECIAL FINISH ON STAINLESS STEEL

This finish is achieved in the final phase of the polishing process. The parts are subjected to a treatment with projection of glass particles. The final result are pieces of uniform matte grey color with a nice texture to be touched. Visually, the pieces have a slight coloring, perfectly suited to environments where no metallic glare is desired. The resulting pieces are completely discreet and integrate in any type of decoration. All our parts can be manufactured in this finish, however there is a limit on the maximum length of 600mm.

JET

ACABADOS ESPECIALES EN ACERO INOXIDABLE

Este acabado se consigue en la fase final del proceso de pulido. Las partes se someten a un tratamiento de proyección de partículas de cristal. El resultado final son piezas de color uniforme gris mate con una textura agradable al tacto. Visualmente, las piezas tienen un color discreto que se adapta perfectamente a entornos en los que el brillo metálico no es adecuado. Las piezas resultantes se quedan perfectamente integradas en el entorno. Todas nuestras piezas pueden ser fabricadas en este acabado, sin embargo hay un límite en longitud máx.de 600mm.

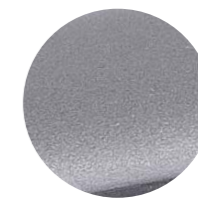

.JET
Aço inoxidável acabamento jet
Stainless steel jet finish /
Acero inox acabado jet /

MATERIAIS E ACABAMENTOS / MATERIALS AND FINISHES / MATERIALES Y ACABADOS /



PVD TITANIUM > FINISH

ACABAMENTO TITÂNIO PVD EM AÇO INOX / ACABADO PVD TITANIO EN ACERO INOX

ACABAMENTOS ESPECIAIS DO AÇO INOX REVESTIDO A TITÂNIO

Este acabamento é conseguido pela tecnologia PVD (Physical Vapor Deposition). É um processo não galvânico, não poluente, amplamente utilizado na indústria da relojoaria.

Trata-se dum acabamento de excepcional qualidade, conferindo ao produto final uma dureza adicional e uma resistência à corrosão elevadíssima.

As nossas peças podem ser fabricadas neste acabamento, existindo uma quantidade mínima por pedido. A medida máxima das peças nestes acabamentos é de 1000mm.

SPECIAL FINISH ON STAINLESS STEEL TITANIUM COATED

This finish is achieved by PVD technology (Physical Vapor Deposition). It is a non galvanic, pollution free process, widely used in the watchmaking industry.

This is an exceptionally high quality finish, giving the final product an additional hardness and a very high corrosion resistance.

Our products can be manufactured in this finish, there is a minimum order quantity. The maximum length of the parts on this finish is 1000mm.

ACABADOS ESPECIALES EN ACERO INOXIDABLE REVESTIDO A TITANIO

Este acabado se consigue mediante la tecnología PVD (Physical Vapor Deposition). Es un proceso no galvánico, no poluente, ampliamente utilizado en la industria de la relojería.

Este es un acabado de calidad excepcionalmente alta, dando el producto final una dureza adicional y una resistencia a la corrosión muy alta.

Nuestras piezas se pueden fabricar en el acabado, hay una cantidad mínima de pedido. La longitud máxima de las piezas en estos acabados es de 1000mm.

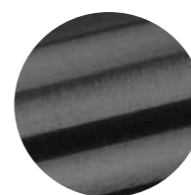

.TB
TITANIUM BLACK
Aço inoxidável + pvd titânio preto /
Stainless steel + pvd titanium black /
Acero inox + pvd titânio negro.

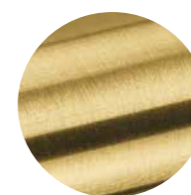

.TG
TITANIUM GOLD
Aço inoxidável + pvd titânio dourado /
Stainless steel + pvd titanium gold /
Acero inox + pvd titânio dorado.

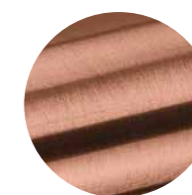

.TCO
TITANIUM COPPER
Aço inoxidável + pvd titânio cobre /
Stainless steel + pvd titanium copper /
Acero inox + pvd titânio cobre.

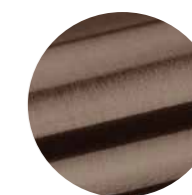

.TCH
TITANIUM CHOCOLATE
Aço inoxidável + pvd titânio chocolate /
Stainless steel + pvd titanium chocolate /
Acero inox + pvd titânio chocolate.

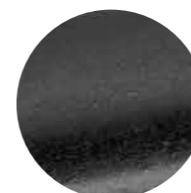

.TCB
TITANIUM COAL BLACK
Aço inoxidável RAW + pvd titânio preto /
RAW stainless steel + pvd titanium black /
Acero inox RAW + pvd titânio negro.

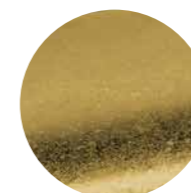

.TAG
TITANIUM AGED GOLD
Aço inoxidável RAW + pvd titânio dourado /
RAW stainless steel + pvd titanium gold /
Acero inox RAW + pvd titânio dorado.



.TAC
TITANIUM AGED COPPER
Aço inoxidável RAW + pvd titânio cobre /
RAW stainless steel + pvd titanium copper /
Acero inox RAW + pvd titânio cobre.



.TAB
TITANIUM AGED BRONZE
Aço inoxidável RAW + pvd titânio bronze /
RAW stainless steel + pvd titanium bronze /
RAW Acero inox + pvd titânio bronze.



.TN
TITANIUM NATURAL
Aço inoxidável + pvd titânio /
Stainless steel + pvd titanium /
Acero inox + pvd titânio.

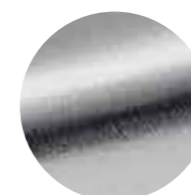

.TMS
JNF MICROSAFE™
Aço inoxidável + MICROsafe™ antimicrobial /
Stainless steel + MICROsafe™ antimicrobial /
Acero inox + MICROsafe™ antimicrobial.

FINISH ON
STAINLESS STEEL

TITANIUM

MATERIAIS E ACABAMENTOS / MATERIALS AND FINISHES / MATERIALES Y ACABADOS /



RAL COLORS > FINISH

ACABAMENTO ESPECIAL EM ALUMÍNIO
 SPECIAL FINISH ON ALUMINIUM / ACABADO ESPECIAL SOBRE ALUMINIO

ACABAMENTO ESPECIAL EM ALUMÍNIO RAL COLORS

Em produtos de grandes dimensões e produzidos em alumínio não é possível adicionar acabamentos PVD, para obter cores diferentes a JNF utiliza a tecnologia de pintura electrostática.

A pintura electrostática é um tipo de revestimento aplicado com um pó seco de fluxo livre. Ao contrário da tinta líquida convencional, que é aplicada por meio de um solvente que evapora, o revestimento em pó é aplicado eletrostaticamente e depois curado com temperatura, garantindo a resistência mecânica ao risco, durabilidade e consistência de cor.

Para obter cores standardizadas, é utilizado o sistema de gestão de cores RAL.

SPECIAL FINISH ON ALUMINIUM RAL COLORS

It is not possible to add PVD finishes to large-sized products produced in aluminium. To obtain different colors, JNF uses electrostatic powder coating technology.

Powder coating is a type of coating applied with free-flowing dry powder. Unlike conventional liquid paint, which is applied using an evaporating solvent, powder coating is electrostatically applied and then cured under heat ensuring mechanical scratch resistance, durability and colour consistency.

In order to get standard colors we use RAL colour management system.

ACABADO ESPECIAL SOBRE ALUMINIO RAL COLORS

No es posible añadir acabados PVD a productos de gran dimension producidos en aluminio, JNF utiliza tecnologia de pintura electrostática para obtener diferentes colores.

La pintura electrostática es un tipo de recubrimiento que se aplica con un polvo seco de flujo libre. A diferencia de la pintura líquida convencional, que se aplica con un solvente que se evapora, el recubrimiento en polvo se aplica electrostáticamente y luego se cura con temperatura, lo que garantiza la resistencia mecánica, los rayones. la durabilidad y la consistencia del color.

Para obtener colores estandarizados se utiliza el sistema de gestión de colores RAL.



**STANDARD
 INOX**
 Alumínio + anodizado satinado /
 Aluminium + satin anodized /
 Aluminio + anodizado satin



**.B
 RAL BLACK**
 Alumínio + RAL 9005 /
 Aluminium + RAL 9005 /
 Aluminio + RAL 9005.



**.GL
 GOLD LEAF**
 Alumínio + gold leaf /
 Aluminium + gold leaf /
 Aluminio + gold leaf



**.SILVER
 RAL SILVER**
 Alumínio + RAL 9006 /
 Aluminium + RAL 9006 /
 Aluminio + RAL 9006.



**.W
 RAL WHITE**
 Alumínio + RAL 9016 /
 Aluminium + RAL 9016 /
 Aluminio + RAL 9016.



DISTRIBUIÇÃO MUNDIAL JNF
JNF WORLD DISTRIBUTION
DISTRIBUCIÓN MUNDIAL JNF

VENDEMOS EM MAIS DE 100 PAÍSES, FAZENDO TUDO O QUE ESTÁ AO NOSSO ALCANCE PARA QUE O CLIENTE FIQUE 100% SATISFEITO.

WE SELL FOR MORE THAN 100 COUNTRIES, MAKING ALL WE CAN DO TO HAVE ALL THE CLIENTS 100% SATISFIED.

VENDEMOS EN MÁS DE 100 PAÍSES, HACEMOS TODO A NUESTRO ALCANCE PARA QUE TODOS LOS CLIENTES QUEDEN 100% SATISFECHOS.

- | | | | | | | | | | |
|----------------|-------------|---------------|------------|------------|------------|----------------|-----------------|---------------|-----------|
| África do sul | Austrália | Chile | Equador | Grécia | Israel | Maurícias | Oman | Rep. Checa | Taiwan |
| Alemanha | Bahamas | China | Eslováquia | Guadalupe | Itália | México | Panamá | Rep. Camarões | Tunísia |
| Angola | Barheïn | Chipre | Eslovénia | Hong Kong | Jordânia | Moçambique | Peru | Roménia | Turquia |
| Antilhas | Bélgica | Colômbia | Espanha | Holanda | Kuwait | Moldávia | Polónia | Rússia | USA |
| Holandesas | Brasil | Coreia do Sul | Estónia | Hungria | Letónia | Nigéria | Porto Rico | Seychelles | Ucrânia |
| Árãbia Saudita | Bulgária | Costa Rica | Finlândia | Indonésia | Líbano | Noruega | Portugal | Singapura | Venezuela |
| Argélia | Cabo verde | Croácia | França | Inglaterra | Lituânia | Nova Caledônia | Qatar | Suiça | |
| Argentina | Canadá | E.A.U. | Gabão | Irlanda | Luxemburgo | Nova Zelândia | Rep. Dominicana | Tailândia | |
| Áustria | Cazaquistão | Egito | Geórgia | Islândia | Marracos | | | | |

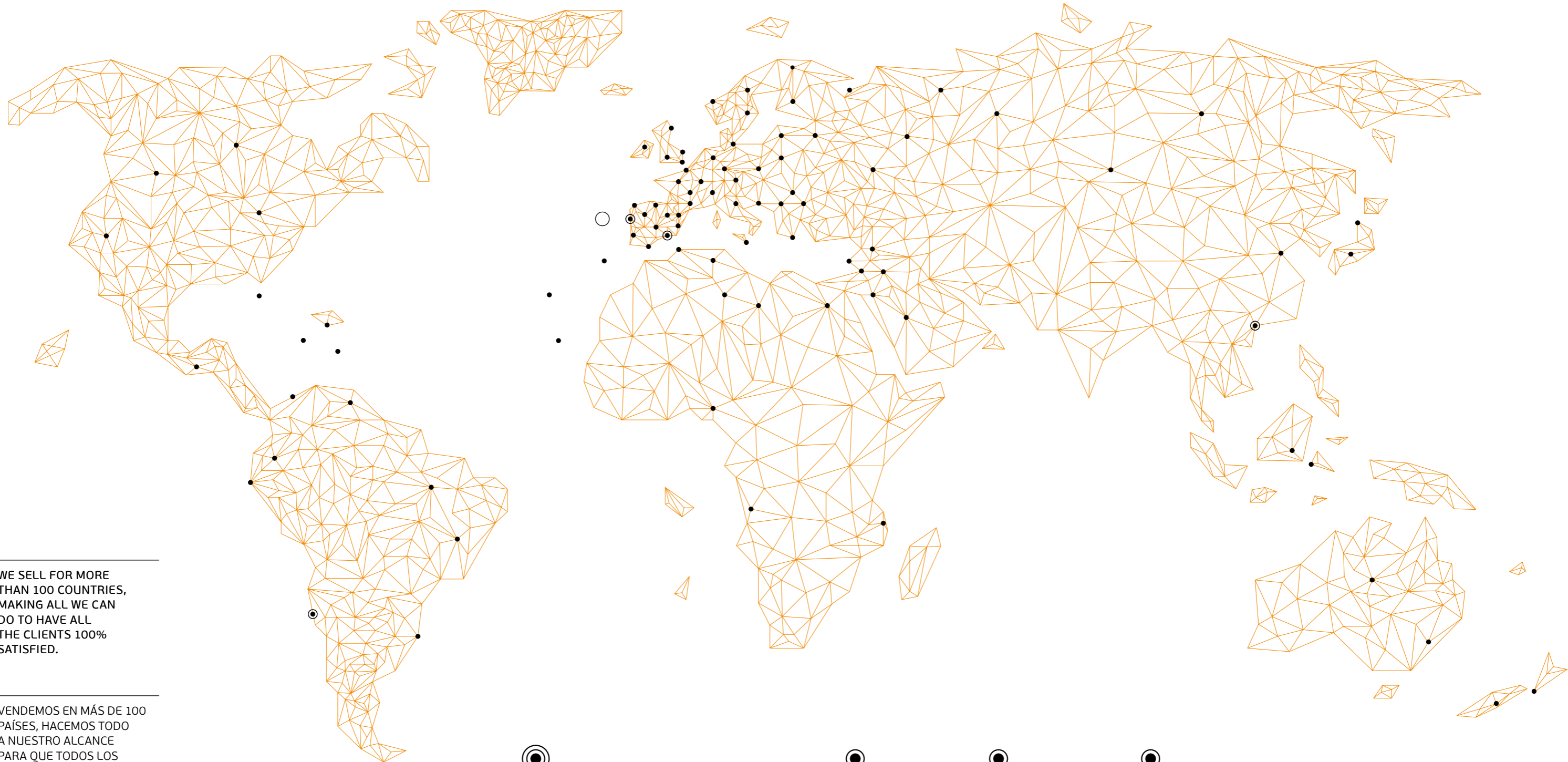

JNF PORTUGAL
Head office / Factory / Showroom



JNF SPAIN
Office / Showroom



JNF ASIA
Office / Showroom



JNF SOUTH AMERICA
Office

CATÁLOGOS JNF FERRAGENS PARA ARQUITECTURA
JNF CATALOGUE ARCHITECTURAL HARDWARE
CATÁLOGOS JNF HERRAJES PARA ARQUITECTURA

NOVO DESIGN /
NEW DESIGN /
NUEVO DESIGN
6 VOLUMES /
6 VOLUMES /
6 VOLUMES

O NOSSO CATÁLOGO ESTÁ DIVIDIDO POR ÁREAS REPRESENTATIVAS DA NOSSA DINÂMICA DE PRODUÇÃO.

OS NOSSOS DISTRIBUIDORES CERTIFICADOS ESTÃO HABILITADOS A FORNECER INFORMAÇÃO SOBRE CADA UM DESTES IMPORTANTES GRUPOS.

OUR CATALOGUE IS DIVIDED BY REPRESENTATIVE AREAS OF OUR PRODUCTION DYNAMICS.

OUR CERTIFIED DISTRIBUTORS ARE ABLE TO PROVIDE INFORMATION ON EACH OF THESE IMPORTANT GROUPS.

NUESTRO CATÁLOGO ESTÁ DIVIDIDO POR ÁREAS REPRESENTATIVAS DE NUESTRA DINÁMICA DE PRODUCCIÓN.

NUESTROS DISTRIBUIDORES CERTIFICADOS PUEDEN PROPORCIONAR INFORMACIÓN SOBRE CADA UNO DE ESTOS IMPORTANTES GRUPOS.



Vol. 5

SOLUÇÕES PARA VIDRO ONDE SE INCLUEM OS GRUPOS DE PRODUTOS:

SOLUTIONS FOR GLASS WHERE THE PRODUCT GROUPS ARE INCLUDED:

SOLUCIONES PARA CRISTAL DONDE SE INCLUYEN LOS GRUPOS DE PRODUCTOS:

SOLUÇÕES PARA PORTAS DE VIDRO PIVOTANTES OU COM DOBRADIÇAS / GLASS DOORS SOLUTIONS FOR PIVOTING OR HINGE SYSTEMS / SOLUCIONES PARA PUERTAS DE CRISTAL PIVOTANTES O BATIENTES.

SOLUÇÕES PARA PORTAS DE CORRER EM VIDRO / SLIDING GLASS DOOR SOLUTIONS / SOLUCIONES PARA PUERTAS CORREDERAS DE CRISTAL

SOLUÇÕES DE FERRAGENS PARA CABINES DE VIDRO / GLASS HARDWARE SOLUTIONS FOR CABINS / SOLUCIONES DE HERRAJES PARA CABINAS DE CRISTAL.

SOLUÇÕES DE FERRAGENS PARA PORTAS DE FOLE E PARQUE / HARDWARE SOLUTIONS FOR FOLDING AND PARK GLASS DOORS / SOLUCIONES DE HERRAJES PARA PUERTAS DE CRISTAL PLEGABLES Y DE PARQUE.

SOLUÇÕES DE FERRAGENS PARA FIXAÇÃO DE VIDROS / HARDWARE SOLUTIONS FOR FIXING GLASS / SOLUCIONES DE HERRAJES PARA FIJAR CRISTAL

SOLUÇÕES GERAIS DE FERRAGENS PARA VIDRO / GENERAL HARDWARE GLASS SOLUTIONS / SOLUCIONES GENERALES DE HERRAJES PARA CRISTAL





Vol. ID

JNF ID > APRESENTAÇÃO E DESCRIÇÃO DA EMPRESA

JNF ID > PRESENTATION AND DESCRIPTION OF THE COMPANY

JNF ID > PRESENTACIÓN Y DESCRIPCIÓN DE LA EMPRESA

A EMPRESA / THE COMPANY / LA EMPRESA

MATERIAL E ACABAMENTOS / MATERIAL AND FINISHES / MATERIAL Y ACABADOS

CERTIFICAÇÕES / CERTIFICATIONS / CERTIFICACIONES

DEPARTAMENTO I&D / I&D DEPARTMENT / DEPARTAMENTO DE I&D

PRODUÇÃO / PRODUCTION / PRODUCCIÓN



Vol. 1

A B C D G J

FERRAGENS PARA PORTAS DE MADEIRA E METÁLICAS

HARDWARE FOR WOODEN AND METALLIC DOORS

HERRAJES PARA PUERTAS DE MADERA Y METÁLICAS

- A PUXADORES DE PORTA E ACESSÓRIOS / DOOR LEVER HANDLES AND ACCESSORIES / MANILLAS DE PUERTA Y ACESSORIOS**
- B ASAS DE PORTA E ACESSÓRIOS / PULL HANDLES AND ACCESSORIES / MANILLONES DE PUERTA Y ACESSORIOS**
- C DOBRADIÇAS E PIVOTS / HINGES AND PIVOTS / BISAGRAS Y PIVOTES**
- D FERRAGENS DIVERSAS / GENERAL HARDWARE / HERRAJES DIVERSAS**
- G FERRAGENS PARA MOBILIÁRIO / FURNITURE HARDWARE / HERRAJES PARA MUEBLES**
- J SINALÉTICA / SIGNAGE / SENALIZACIÓN**



Vol. 2

E

SISTEMAS PARA PORTAS DE CORRER

SLIDING DOOR SYSTEMS

SISTEMAS PARA PUERTAS CORREDERAS

- SISTEMA PARA PORTAS DE CORRER AUTOMÁTICAS / AUTOMATIC SLIDING DOOR SYSTEM / SISTEMA DE PUERTAS CORREDERAS AUTOMATICAS**
- PORTAS DE CORRER COM CARRIL EM ALUMÍNIO / MANUAL DOORS WITH ALUMINIUM TRACK / PUERTAS CORREDERAS CON RIEL EN ALUMINIO**
- SISTEMA PARA PORTAS DE CORRER OCULTO / OFFSCREEN SLIDING DOOR SYSTEM / SISTEMA DE PUERTAS CORREDERAS OCULTO**
- PORTAS MANUAIS EM AÇO INOX / STAINLESS STEEL MANUAL DOORS / PORTAS MANUALES DE ACERO INOXIDABLE**
- SISTEMA PARA PORTAS DE CORRER DE PAVIMENTO / SLIDING DOOR SYSTEMS ON THE FLOOR / SISTEMAS DE PUERTAS CORREDERAS DE PAVIMENTO**
- SISTEMA PARA PORTAS DE CORRER DE LIVRO / FOLDING DOOR SYSTEMS / SISTEMAS DE PUERTAS PLEGABLES**



Vol. 3

F

SOLUÇÕES PARA VIDRO

GLASS SOLUTIONS

SOLUCIONES PARA CRISTAL

- SOLUÇÕES PARA PORTAS DE VIDRO PIVOTANTES OU COM DOBRADIÇAS / GLASS DOORS SOLUTIONS FOR PIVOTING OR HINGE SYSTEMS / SOLUCIONES PARA PUERTAS DE CRISTAL PIVOTANTES O BATIENTES.**
- SOLUÇÕES PARA PORTAS DE CORRER EM VIDRO / SLIDING GLASS DOOR SOLUTIONS / SOLUCIONES PARA PUERTAS CORREDERAS DE CRISTAL.**
- SOLUÇÕES DE FERRAGENS PARA CABINES DE VIDRO / GLASS HARDWARE SOLUTIONS FOR CABINS / SOLUCIONES DE HERRAJES PARA CABINAS DE CRISTAL.**
- SOLUÇÕES DE FERRAGENS PARA PORTAS DE FOLE E PARQUE / HARDWARE SOLUTIONS FOR FOLDING AND PARK GLASS DOORS / SOLUCIONES DE HERRAJES PARA PUERTAS DE CRISTAL PLEGABLES Y DE PARQUE.**
- SOLUÇÕES DE FERRAGENS PARA FIXAÇÃO DE VIDROS / HARDWARE SOLUTIONS FOR FIXING GLASS / SOLUCIONES DE HERRAJES PARA FIJAR CRISTAL.**
- SOLUÇÕES GERAIS DE FERRAGENS PARA VIDRO / GENERAL HARDWARE GLASS SOLUTIONS / SOLUCIONES GENERALES DE HERRAJES PARA CRISTAL.**



Vol. 4

H I

SISTEMAS DE FECHO E CONTROLOS DE ACESSOS

LOCKING SYSTEMS AND ACCESS CONTROL SYSTEMS

SISTEMAS DE CIERRE Y CONTROL DE ACCESO

- FECHADURAS E CILINDROS / LOCKS AND CYLINDERS / CERRADURAS Y CILINDROS**
- DISPOSITIVOS ELECTROMAGNÉTICOS / ELECTROMAGNETIC DEVICES / DISPOSITIVOS ELECTROMAGNÉTICOS**
- H BARRAS ANTI-PÂNICO / ANTI-PANIC BARS / BARRAS DE ANTIPÁNICO**
- MOLAS DE PORTA E VEDANTES / DOOR CLOSERS AND DROP SEALS / MUELLES DE PUERTA Y SELLOS PARA PUERTAS**
- SISTEMAS DE CONTROLO DE ACESSOS / ACCESS CONTROL SYSTEMS / SISTEMAS DE CONTROL DE ACCESO**
- I LEITORES DE PAREDE / WALL READERS / LECTORES DE PARED**
- TECLADOS NUMÉRICOS / NUMERIC KEYPAD / TECLADOS NUMÉRICOS**



Vol. 5

K L

ACESSÓRIOS PARA WC E SOLUÇÕES PARA CABINES SANITÁRIAS

BATHROOM ACCESSORIES AND SANITARY BOOTH HARDWARE

ACCESORIOS DE BAÑO Y SOLUCIONES PARA CABINAS SANITARIAS

- ACESSÓRIOS PARA CASA DE BANHO / BATHROOM ACCESSORIES / ACCESORIOS DE BAÑO**
- CLEANING SYSTEMS / CLEANING SYSTEMS / CLEANING SYSTEMS**
- K AUXÍLIOS TÉCNICOS PARA PESSOAS COM MOBILIDADE REDUZIDA / TECHNICAL AID FOR PEOPLE WITH CONDITIONED MOBILITY / AYUDAS TÉCNICAS PARA PERSONAS CON MOVILIDAD CONDICIONADA**
- L SISTEMAS MODULARES PARA CABINES SANITÁRIAS / SANITARY BOOTH HARDWARE / HERRAJES PARA CABINAS SANITÁRIAS**



SOLUÇÕES PARA VIDRO / SOLUTIONS FOR GLASS / SOLUCIONES PARA CRISTAL.

O VIDRO É UM DOS MATERIAIS CADA VEZ MAIS UTILIZADO NA CONSTRUÇÃO EM COMPARTIMENTAÇÃO DE ESPAÇOS, EM PORTAS E JANELAS, EM DIVISÓRIAS, A NÍVEL ESTRUTURAL, EM FACHADAS DE EDIFÍCIOS, SÓ PARA CITAR ALGUNS EXEMPLOS.

AS FERRAGENS PARA VIDRO SÃO UM ELEMENTO ESSENCIAL PARA A REALIZAÇÃO DESTAS SOLUÇÕES EM VIDRO. O NÍVEL TÉCNICO E A QUALIDADE DAS FERRAGENS SÃO UM REQUISITO INQUESTIONÁVEL PARA A REALIZAÇÃO DE PROJECTOS EXIGENTES.

A SOFISTICAÇÃO DE TODAS ESTAS SOLUÇÕES EXIGE ELEVADOS PADRÕES DE QUALIDADE NA PRODUÇÃO DAS FERRAGENS, A JNF É DETENTORA DA TECNOLOGIA MAIS EDEQUADA PARA ATINGIR ESSE PATAMAR TÉCNICO DE RIGOR.

A INSTALAÇÃO TAMBÉM É UMA FASE CRÍTICA NA REALIZAÇÃO DO PROJECTO. AS NOSSAS SOLUÇÕES FORAM ESTUDADAS ATÉ AO MÍNIMO DETALHE PARA GARANTIR UMA INSTALAÇÃO PERFEITA SEM RECURSO A IMPROVISOS EM OBRA.

INOVAÇÃO NAS SOLUÇÕES, SEGURANÇA DAS MÊSMAS, CUMPRIMENTO DE NORMATIVAS SÃO PADRÕES SEMPRE PRESENTES NA CONCEÇÃO DAS NOSSAS FERRAGENS PARA VIDRO. OS MATERIAIS UTILIZADOS, SÃO O ALUMÍNIO, O AÇO INOX EM EM VÁRIAS LIGAS E O ACABAMENTO DE SUPERFÍCIE É UM DOS MAIS AMPLOS DO MERCADO.

THE GLASS IS ONE OF THE MATERIALS THAT EACH TIME IS MORE USED IN CONSTRUCTION IN COMPARTMENTALIZING SPACES, DOORS, WINDOWS AND PARTITIONS, IN STRUCTURAL LEVEL IN BUILDING FACADES, JUST TO NAME A FEW EXAMPLES.

GLASS FITTINGS ARE AN ESSENTIAL ELEMENT FOR THE REALIZATION OF THESE SOLUTIONS IN GLASS. THE TECHNICAL LEVEL AND QUALITY OF THE HARDWARE ARE AN UNQUESTIONABLE REQUIREMENT FOR CARRYING OUT DEMANDING PROJECTS.

THE SOPHISTICATION OF ALL THESE SOLUTIONS DEMANDS HIGH STANDARDS QUALITY STANDARDS IN THE PRODUCTION OF HARDWARE, JNF HOLDS THE MOST APPROPRIATE TECHNOLOGY TO REACH THIS LEVEL OF TECHNICAL ACCURACY.

INSTALLATION IS ALSO A CRITICAL PHASE IN THE REALIZATION OF THE PROJECT. OUR SOLUTIONS HAVE BEEN STUDIED DOWN TO THE SMALLEST DETAIL TO GUARANTEE A PERFECT INSTALLATION WITHOUT RESORTING TO IMPROVISATIONS ON SITE.

INNOVATION IN SOLUTIONS, THEIR SAFETY, COMPLIANCE WITH REGULATIONS ARE STANDARDS THAT ARE ALWAYS PRESENT IN THE DESIGN OF OUR GLASS FITTINGS. THE MATERIALS USED ARE ALUMINIUM, STAINLESS STEEL IN VARIOUS ALLOYS AND THE SURFACE FINISH IS ONE OF THE WIDEST ON THE MARKET.

EL VIDRIO ES UNO DE LOS MATERIALES QUE CADA VEZ SE UTILIZA MÁS EN LA CONSTRUCCIÓN, COMPARTIMENTACIÓN DE ESPACIOS, PUERTAS, VENTANAS, A NIVEL ESTRUCTURAL, EN FACHADAS DE EDIFICIOS, POR CITAR ALGUNOS EJEMPLOS.

LOS HERRAJES PARA VIDRIO SON UN ELEMENTO ESENCIAL PARA LA REALIZACIÓN DE ESTAS SOLUCIONES EN VIDRIO. EL NIVEL TÉCNICO Y LA CALIDAD DE LOS HERRAJES SON UN REQUISITO INDISCUTIBLE PARA LA REALIZACIÓN DE PROYECTOS EXIGENTES.

LA SOFISTICACIÓN DE TODAS ESTAS SOLUCIONES REQUIERE ALTOS ESTÁNDARES DE CALIDAD EN LA PRODUCCIÓN DE HERRAJES, JNF POSEE LA TECNOLOGÍA MÁS ADECUADA PARA ALCANZAR ESTE NIVEL TÉCNICO DE RIGOR.

LA INSTALACIÓN ES TAMBIÉN UNA FASE CRÍTICA EN LA REALIZACIÓN DEL PROYECTO. NUESTRAS SOLUCIONES HAN SIDO ESTUDIADAS HASTA EL MÁS MÍNIMO DETALLE PARA GARANTIZAR UNA PERFECTA INSTALACIÓN SIN RECURRIR A IMPROVISACIONES EN OBRA.

LA INNOVACIÓN EN LAS SOLUCIONES, SU SEGURIDAD, EL CUMPLIMIENTO DE LA NORMATIVA SON ESTÁNDARES QUE SIEMPRE ESTÁN PRESENTES EN EL DISEÑO DE NUESTROS HERRAJES PARA VIDRIO. LOS MATERIALES UTILIZADOS SON ALUMINIO, ACERO INOXIDABLE EN DIVERSAS ALEACIONES Y EL ACABADO SUPERFICIAL ES UNO DE LOS MÁS AMPLOS DEL MERCADO.

INDICE / INDEX / INDICE



SOLUÇÕES PARA PORTAS PIVOTANTES OU COM DOBRADIÇAS /
 GLASS DOORS SOLUTIONS FOR PIVOTING OR HINGE SYSTEMS /
 SOLUCIONES PARA PUERTAS DE CRISTAL PIVOTANTES O BATIENTES /

018 SISTEMAS PIVOTANTES PARA VIDRO
 PIVOTS SYSTEM FOR GLASS /
 SISTEMAS DE PIVOTE PARA CRISTAL
W SYSTEM
H SYSTEM
H2 SYSTEM

040 DOBRADIÇAS HIDRÁULICAS PARA VIDRO /
 HYDRAULIC HINGES FOR GLASS /
 BISAGRAS HIDRAULICAS PARA CRISTAL.

044 DOBRADIÇAS PARA VIDRO /
 HINGES FOR GLASS /
 BISAGRAS PARA CRISTAL.

046 BARRAS ANTI-PÂNICO PARA PORTAS DE VIDRO
 PANIC EXIT DEVICES FOR GLASS DOORS /
 DISPOSITIVOS ANTIPANICO PARA PUERTAS DE CRISTAL.

054 MOLAS PARA PORTAS DE VIDRO /
 FLOOR CLOSERS FOR GLASS DOORS /
 CIERRE PARA PUERTAS DE CRISTAL.

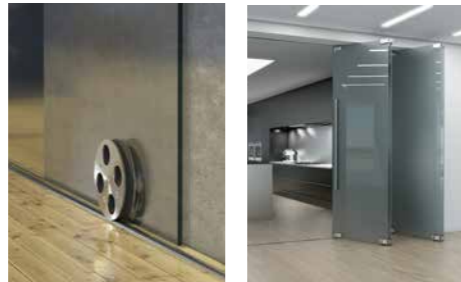

SOLUÇÕES DE PORTAS DE CORRER E DE LIVRO MANUAIS /
 SLIDING AND FOLDING GLASS DOOR SOLUTIONS /
 SOLUCIONES PARA PUERTAS CORREDERAS O PLEGABLES.

068 SISTEMAS MANUAIS PARA PORTAS DE VIDRO COM CARRIL DE ALUMÍNIO /
 MANUAL SLIDING DOOR SYSTEMS WITH ALUMINIUM TRACK /
 SISTEMAS MANUALES PARA PUERTAS CORREDERAS CON CARRIL DE ALUMINIO.
LINEAR
MECANO

096 GRAVITY SYSTEM - SISTEMAS PARA PORTAS DE CORRER /
 SLIDING DOOR SYSTEM /
 SISTEMA PARA PUERTAS CORREDERAS

104 SISTEMA MODULAR PARA PORTAS DE VIDRO (Ø25mm) /
 MODULAR SYSTEM FOR GLASS DOORS /
 SISTEMA MODULAR PARA PUERTAS CORREDERAS DE CRISTAL (Ø25mm)

142 SISTEMA COMPLETO PARA PORTAS DE CORRER EM VIDRO (Ø20MM) /
 COMPLETE SYSTEM FOR GLASS SLIDING DOORS (Ø20mm) /
 SISTEMA COMPLETO PARA PUERTAS CORREDERAS EN CRISTAL (Ø20mm)

146 SISTEMA PARA PORTAS DE CORRER DE PAVIMENTO
 SLIDING DOOR SYSTEM ON THE FLOOR /
 SISTEMA PARA PUERTAS CORREDERAS DE PAVIMENTO

156 SOLUÇÕES DE FERRAGENS PARA PORTAS DE FOLE E PARQUE /
 GLASS HARDWARE SOLUTIONS FOR FOLDING AND PARK DOORS /
 SOLUCIONES DE HERRAJES PARA PUERTAS PLEGABLES Y DE PARQUE.



SOLUÇÕES DE PORTAS DE VIDRO AUTOMÁTICAS /
 AUTOMATIC SLIDING GLASS DOOR SOLUTIONS /
 SOLUCIONES PARA PUERTAS CORREDERAS AUTOMATICAS /

176 SISTEMAS PARA PORTAS DE CORRER AUTOMÁTICAS
 AUTOMATIC SLIDING DOOR SYSTEMS /
 SISTEMAS DE PUERTAS CORREDERAS AUTOMATICAS.
LINEAR POLARIS
MECANO ELECTRON
K7 SYSTEM

200 CONCIERGE AUTOMÁTICO /
 AUTOMATIC CONCIERGE /
 CONSERJE AUTOMATICO

206 ACESSÓRIOS PARA PORTAS AUTOMÁTICAS /
 ACCESSORIES FOR AUTOMATIC DOORS /
 ACCESORIOS PARA PUERTAS AUTOMÁTICAS.



SOLUÇÕES DE FERRAGENS PARA CABINES DE VIDRO /
 GLASS HARDWARE SOLUTIONS FOR CABINS /
 SOLUCIONES DE HERRAJES PARA CABINAS DE CRISTAL /

216 SOLUÇÕES DE FERRAGENS PARA CABINES DE VIDRO /
 GLASS HARDWARE SOLUTIONS FOR CABINS /
 SOLUCIONES DE HERRAJES PARA CABINAS DE CRISTAL
SLIM SHOWER SYSTEM
CLEAR SHOWER SYSTEM
CLEAR TWIN SHOWER SYSTEM

246 SISTEMAS DE DOBRADIÇAS E SUPORTES PARA VIDRO /
 HINGE AND SUPPORT SYSTEMS FOR GLASS /
 SISTEMAS DE BISAGRAS Y SOPORTES PARA CRISTAL
SHOWER HINGES
SELF CLOSING SHOWER HINGES
MODULAR STABILIZER

268 SOLUÇÕES DE FERRAGENS PARA CABINES DE VIDRO /
 GLASS HARDWARE SOLUTIONS FOR CABINS
 SOLUCIONES DE HERRAJES PARA CABINAS DE VIDRIO

278 VEDANTES PARA VIDRO (8-12MM) /
 PVC SEALS FOR GLASS (8-12MM) /
 SELLOS PARA CRISTAL (8-12MM)

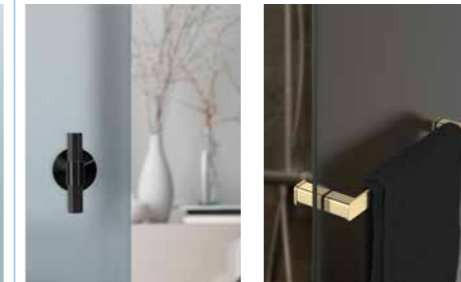

SOLUÇÕES DE PUXADORES, ASAS E FECHADURAS PARA PORTAS DE VIDRO /
 KNOBS, PULL HANDLES AND LOCKS SOLUTIONS FOR GLASS DOORS /
 SOLUCIONES DE POMOS, MANILLONES Y CERRADURAS PARA PUERTAS DE VIDRIO.

284 FECHADURAS PARA PORTAS DE VIDRO /
 LOCKS FOR GLASS DOORS /
 CERRADURAS PARA PUERTAS DE CRISTAL

318 ASAS PARA PORTA DE VIDRO COM FECHADURA /
 LOCKS FOR GLASS DOORS /
 CERRADURAS PARA PUERTAS DE CRISTAL

323 PUXADORES FIXOS PARA PORTAS DE VIDRO
 PULL HANDLES FOR GLASS DOORS WITH LOCK /
 MANILLONES PARA PUERTAS DE CRISTAL COM CIERRE

338 PUXADORES/TOALHEIROS PARA PORTAS DE VIDRO
 HANDLES/TOWEL RACKS FOR GLASS DOORS /
 MANILLAS/TOALLEROS PARA PUERTAS DE CRISTAL

344 ASAS PARA PORTAS DE VIDRO
 PULL HANDLES FOR GLASS DOORS /
 MANILLONES PARA PUERTAS DE CRISTAL

390 CONCHAS PARA VIDRO /
 FLUSH HANDLES FOR GLASS /
 CAZOLETAS PARA CRISTAL



SOLUÇÕES GERAIS DE FERRAGENS PARA VIDRO /
 GLASS GENERAL HARDWARE SOLUTIONS /
 SOLUCIONES GENERALES DE HERRAJES PARA CRISTAL.

396 SISTEMAS DE FIXAÇÃO PARA VIDRO /
 SUPPORT SYSTEMS FOR GLASS /
 SISTEMAS DE FIJACIÓN PARA CRISTAL.

414 PINÇAS PARA VIDRO
 GLASS CLAMPS /
 PINZAS PARA CRISTAL

420 BARREIRAS DE CONFINAMENTO
 CONTAINMENT BARRIER /
 BARRERA DE CONTENCIÓN

428 SISTEMA DE FIXAÇÃO PARA ALPENDRES DE VIDRO
 GLASS CANOPIES SYSTEM /
 SISTEMA PARA CUBIERTA EM CRISTAL

432 SUPORTES PARA VIDRO
 GLASS SUPPORTS /
 SOPORTES PARA CRISTAL

434 FERRAGENS PARA VITRINES
 SHOWCASE HARDWARE /
 HERRAJES PARA VITRINA

436 SUPORTES PARA VIDRO
 GLASS SUPPORTS /
 SOPORTES PARA CRISTAL

438 BATENTES PARA PORTAS DE VIDRO
 DOOR STOPPERS FOR GLASS DOORS /
 TOPES PARA PUERTAS DE CRISTAL

442 CABIDES
 HOOKS /
 PERCHAS.

SOLUÇÕES PARA PORTAS PIVOTANTES OU COM DOBRADIÇAS / GLASS DOORS SOLUTIONS FOR PIVOTING OR HINGE SYSTEMS / SOLUCIONES PARA PUERTAS DE CRISTAL PIVOTANTES O BATIENTES.

SISTEMAS PIVOTANTES PARA VIDRO

PIVOTS SYSTEM FOR GLASS /
 SISTEMAS DE PIVOTE PARA CRISTAL
 W SYSTEM
 W 360° SYSTEM
 H SYSTEM
 H2 SYSTEM

DOBRADIÇAS HIDRÁULICAS PARA VIDRO /

HYDRAULIC HINGES FOR GLASS /
 BISAGRAS HIDRAULICAS PARA CRISTAL.

DOBRADIÇAS PARA VIDRO /

HINGES FOR GLASS /
 BISAGRAS PARA CRISTAL.

BARRAS ANTI-PÂNICO PARA PORTAS DE VIDRO

PANIC EXIT DEVICES FOR GLASS DOORS /
 DISPOSITIVOS ANTIPANICO PARA PUERTAS DE CRISTAL.

MOLAS PARA PORTAS DE VIDRO /

FLOOR CLOSERS FOR GLASS DOORS /
 CIERRE PARA PUERTAS DE CRISTAL.



W System

SISTEMAS PIVOTANTES PARA VIDRO /
PIVOTS SYSTEMS FOR GLASS /
SISTEMAS DE PIVOTE PARA CRISTAL.**W SYSTEM
HYDRAULIC
PATCH FITTING
FOR GLASS**

CONJUNTO COMPLETO DE PIVOT
HIDRÁULICO PARA PORTAS DE VIDRO /
HYDRAULIC PIVOT
SET FOR GLASS DOORS /
JUEGO COMPLETO DE PIVOTE
HIDRÁULICO PARA PUERTAS DE CRISTAL.

**CONJUNTO COMPLETO DE PIVOT
HIDRÁULICO PARA PORTAS DE VIDRO.**

- Aplicável à superfície
- 2 velocidades de fecho reguláveis por válvulas.
- Aplicável à superfície do pavimento sem trabalho de alvenaria
- Largura máxima da porta 1000mm.
- Peso máximo 100kg.
- Espessura do vidro 10-13mm.
- Patente internacional.
- Sistema de ajuste da posição da porta
↙ ±3mm | ↘ ±3mm / 4° ▷ (consultar dt*)

**HYDRAULIC PIVOT
SET FOR GLASS DOORS.**

- Surface mounting
- 2 closing speeds with valve regulation.
- Application in the pavement surface without masonry work
- Max. door width 1000mm.
- Max. weight up to 100 kg.
- Glass thickness 10-13mm.
- International patent.
- System for door position adjustment
↙ ±3mm | ↘ ±3mm / 4° ▷ (consult dw*)

**JUEGO COMPLETO DE PIVOTE
HIDRÁULICO PARA PUERTAS DE CRISTAL.**

- Aplicable a la superficie
- 2 velocidades de cierre regulables por válvulas.
- Aplicación en la superficie del pavimento sin trabajos de albañilería.
- Anchura máx. de la puerta 1000mm.
- Peso máx. 100kg.
- Espesor del cristal 10-13mm.
- Patente Internacional.
- Sistema para ajustar la posición de puerta
↙ ±3mm | ↘ ±3mm / 4° ▷ (ver dibujo*)

W System

SISTEMAS PIVOTANTES PARA VIDRO /
PIVOTS SYSTEMS FOR GLASS /
SISTEMAS DE PIVOTE PARA CRISTAL.

3 Fixed power
No power
adjustment



IN.81.203 W SYSTEM FOR GLASS
Pivot hidráulico / Hydraulic pivot / Pivote hidráulico
Satinado / Satin/ Satin



IN.81.203.P W SYSTEM FOR GLASS
Pivot hidráulico / Hydraulic pivot / Pivote hidráulico
Polido / Polished/ Pulido



IN.81.203.B W SYSTEM FOR GLASS
Pivot hidráulico / Hydraulic pivot / Pivote hidráulico
Satinado / Satin/ Satin



IN.81.203.B.P W SYSTEM FOR GLASS
Pivot hidráulico / Hydraulic pivot / Pivote hidráulico
Polido / Polished/ Pulido

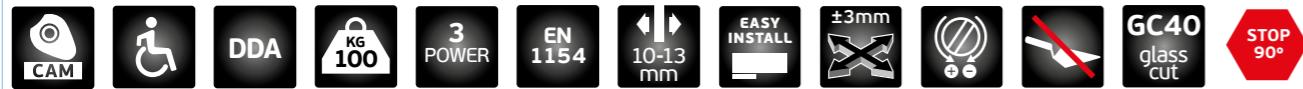

Conjunto completo de pivot hidráulico para portas de vidro.
Duas velocidades de fecho reguláveis por válvulas.
Largura máx. da porta 1000mm.
Peso máx. 100kg.
Espessura do vidro 10-13mm.
Patente internacional.
Sistema de ajuste da posição da porta
±3mm | ±3mm / 4° (consultar dt *)
Aplicavel à superfície do pavimento

Hydraulic pivot set for glass doors
Two speeds closing valve regulation.
Max. door width 1000mm.
Max. weight up to 100kg.
Glass thickness 10-13mm.
International patent.
System for door position adjustment
±3mm | ±3mm / 4° (consult dw *)
Installation on floor surface

Juego completo de pivote hidráulico para puertas de cristal. Dos velocidades de cierre regulables por válvulas. Anchura máx. de la puerta 1000mm. Peso máx. 100kg. Espesor del cristal 10-13mm. Patente Internacional. Sistema para ajustar la posición de puerta ±3mm | ±3mm / 4° (ver dibujo *) Aplicable a superficie do suelo

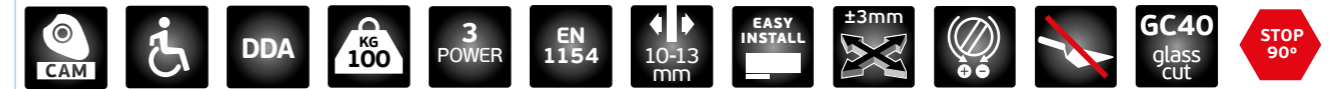

Pivot hidráulico inferior para portas de vidro.
Duas velocidades de fecho reguláveis por válvulas.
Largura máx. da porta 1000mm.
Peso máx. 100kg.
Espessura do vidro 10-13mm.
Patente internacional.
Sistema de ajuste da posição da porta
±3mm | ±3mm / 4° (consultar dt *)
Aplicavel à superfície do pavimento

Hydraulic bottom pivot for glass doors
Two speeds closing valve regulation.
Max. door width 1000mm.
Max. weight up to 100kg.
Glass thickness 10-13mm.
International patent.
System for door position adjustment
±3mm | ±3mm / 4° (consult dw *)
Installation on floor surface

Pivote bajo hidráulico para puertas de cristal. Dos velocidades de cierre regulables por válvulas. Anchura máx. de la puerta 1000mm. Peso máx. 100kg. Espesor del cristal 10-13mm. Patente Internacional. Sistema para ajustar la posición de puerta ±3mm | ±3mm / 4° (ver dibujo *) Aplicable a superficie do suelo



IN.81.203.TB
EN 1.4301 + Titanium Black

IN.81.203.TCH
EN 1.4301 + Titanium chocolate

IN.81.203.TCO
EN 1.4301 + Titanium copper

IN.81.203.TG
EN 1.4301 + Titanium gold

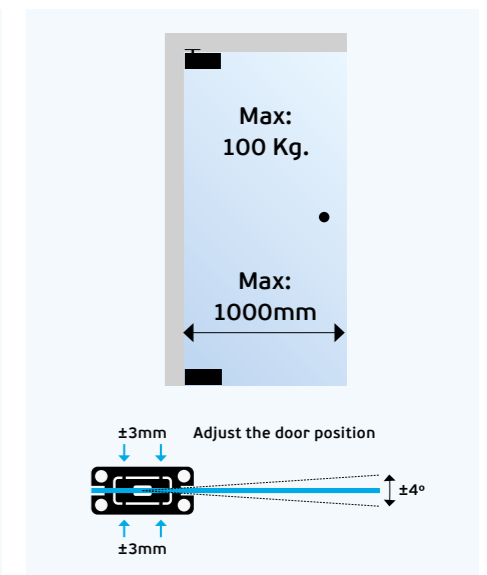
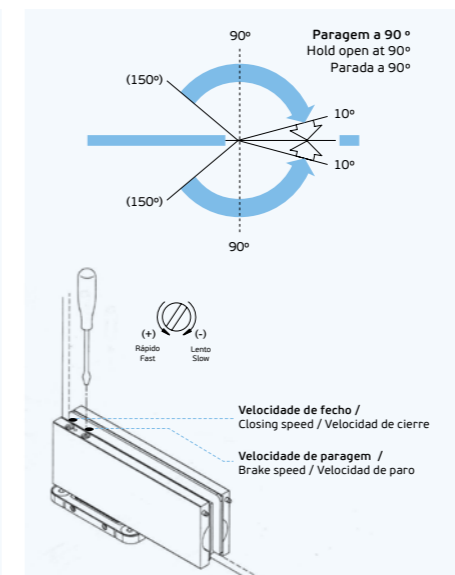
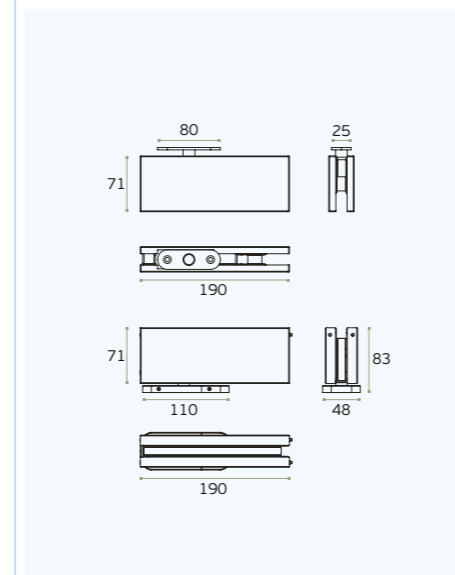

W System

SISTEMAS PIVOTANTES PARA VIDRO /
PIVOTS SYSTEMS FOR GLASS /
SISTEMAS DE PIVOTE PARA CRISTAL.



IN.81.204 W SYSTEM FOR GLASS
Suporte superior de bandeira reversível para IN.81.203 /
Upper reversible support for IN.81.203.
Soporte superior de bandera reversible para IN.81.203.
Satinado / Satin/ Satin



IN.81.204.P W SYSTEM FOR GLASS
Suporte superior de bandeira reversível para IN.81.203 /
Upper reversible support for IN.81.203.
Soporte superior de bandera reversible para IN.81.203.
Polido / Polished/ Pulido

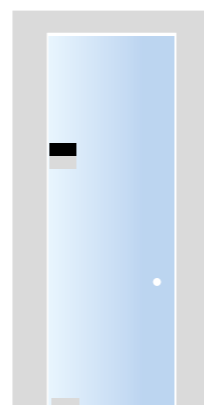
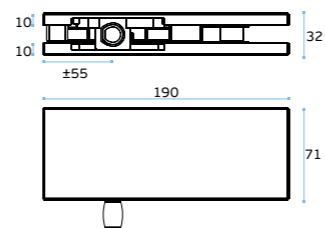

**W SYSTEM
HYDRAULIC
PATCH FITTING
FOR GLASS**

CONJUNTO COMPLETO DE PIVOT
HIDRÁULICO PARA PORTAS DE VIDRO /
HYDRAULIC PIVOT
SET FOR GLASS DOORS /
JUEGO COMPLETO DE PIVOTE
HIDRÁULICO PARA PUERTAS DE CRISTAL.

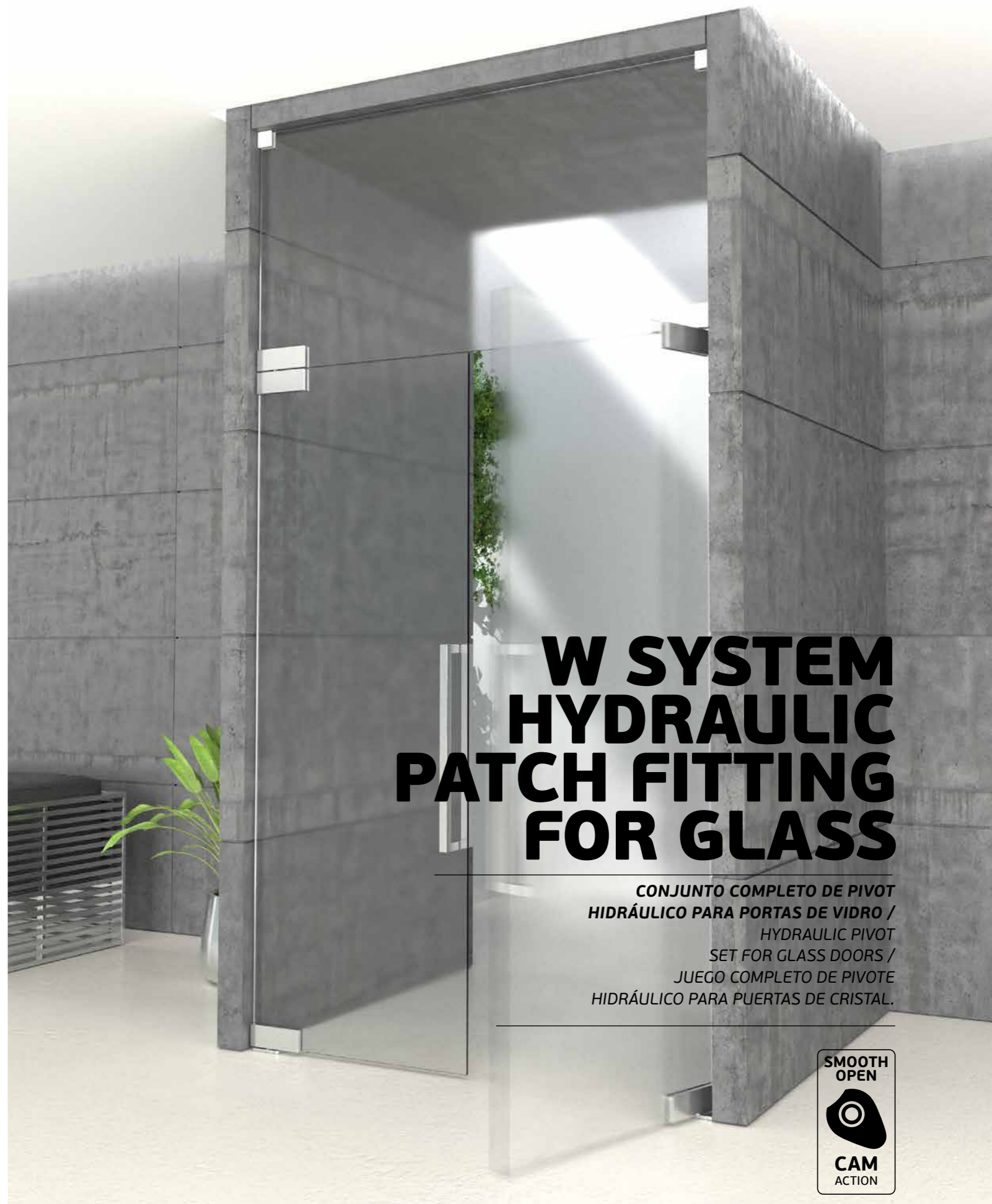
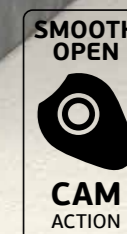

W 360° System
**SISTEMAS PIVOTANTES PARA VIDRO /
 PIVOTS SYSTEMS FOR GLASS /
 SISTEMAS DE PIVOTE PARA CRISTAL.**

Sistema pivotante para portas de vidro de grandes dimensões. O sistema CAM integrado neste pivot permite que a porta possa fazer uma rotação de 360°, mantendo o sistema hidráulico com fecho automático e suave. Para funcionar desta forma o pivot superior e inferior terão de estar instalados ao centro da porta.

Pivoting system for large glass doors. The CAM system integrated in this pivot allows the door to rotate 360°, maintaining the hydraulic system with automatic and soft closing. To function in this way the upper and lower pivot must be installed in the centre of the door.

Sistema pivotante para portas de cristal de grandes dimensões. El sistema CAM integrado en este pivote permite que la puerta gire 360°, manteniendo el sistema hidráulico con cierre automático y suave. Para funcionar de este modo, el pivote superior e inferior deben instalarse en el centro de la puerta.



Sistema pivotante para portas de vidro de grandes dimensões. O sistema CAM integrado neste pivot permite que a porta possa fazer uma abertura de quase 360°, mantendo o sistema hidráulico com fecho automático e suave. A grande vantagem deste sistema é o facto de poder ser instalado em quase qualquer posição na porta, desde o centro até 5cm do limite. Permite grandes vãos de abertura assim como peso máximo até 200KG.

Pivoting system for large glass doors. The CAM system integrated in this pivot allows the door to open almost 360°, maintaining the hydraulic system with automatic and soft closing. The great advantage of this system is that it can be installed in almost any position on the door, from the centre to 5cm from its limit. It allows large opening spans as well as maximum weight up to 200KG.

Sistema pivotante para grandes portas de cristal. El sistema CAM integrado en este pivote permite que la puerta se abra casi 360°, manteniendo el sistema hidráulico con cierre automático y suave. La gran ventaja de este sistema es que puede instalarse en casi cualquier posición de la puerta, desde el centro hasta 5 cm de su límite. Permite grandes luces de apertura y un peso máximo de hasta 200KG.

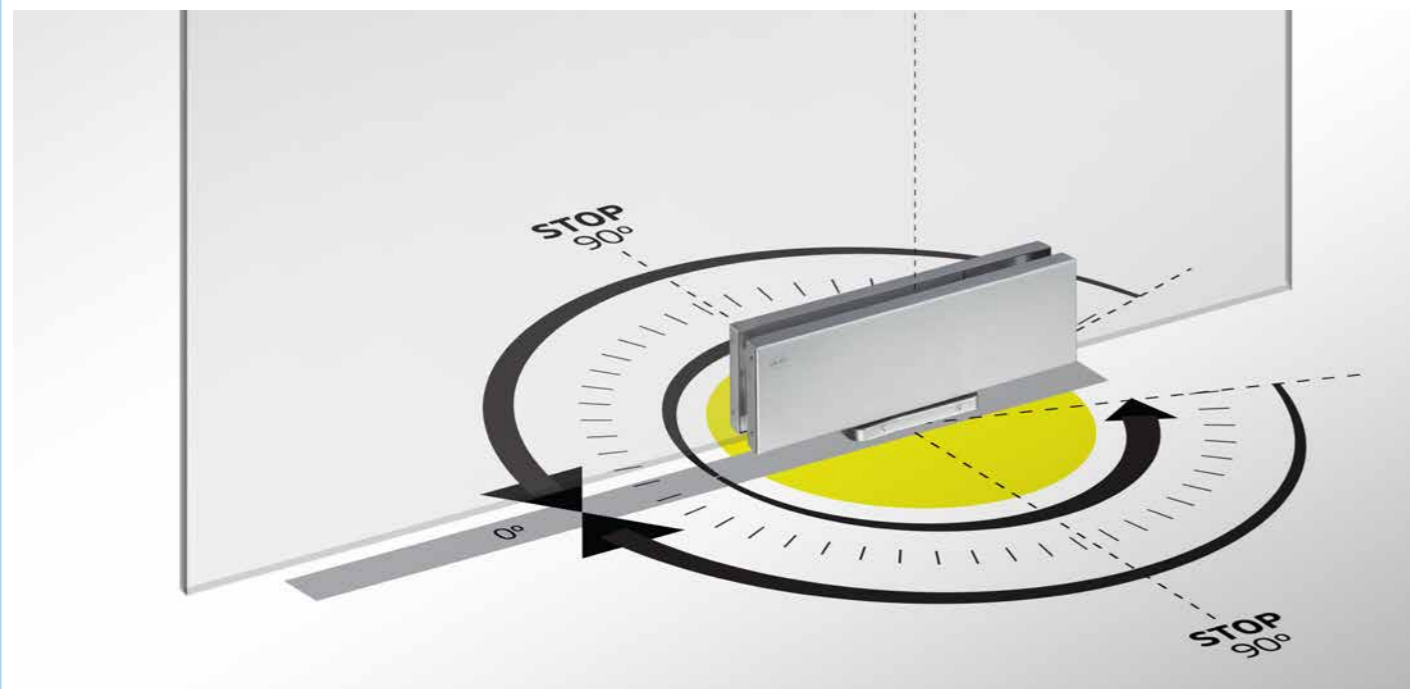

W 360° HYDRAULIC PATCH FITTING FOR GLASS

CONJUNTO COMPLETO DE PIVOT
 HIDRÁULICO PARA PORTAS DE VIDRO /
 HYDRAULIC PIVOT
 SET FOR GLASS DOORS /
 JUEGO COMPLETO DE PIVOTE
 HIDRÁULICO PARA PUERTAS DE CRISTAL.

SMOOTH
OPEN
 CAM
ACTION

PATENTED
GLASS FLOOR
SPRING

5 Fixed power
No power
adjustment

W 360° System

SISTEMAS PIVOTANTES PARA VIDRO /
PIVOTS SYSTEMS FOR GLASS /
SISTEMAS DE PIVOTE PARA CRISTAL.



5 Fixed power
No power
adjustment

IN.81.206 W 360° SYSTEM FOR GLASS
Pivot hidráulico / Hydraulic pivot / Pivote hidráulico
Satinado / Satin / Satin



**CONJUNTO COMPLETO DE PIVOT
HIDRÁULICO PARA PORTAS DE VIDRO.**

- Velocidade de fecho regulável por válvula.
- Aplicável à superfície do pavimento sem trabalho de alvenaria.
- Largura máxima da porta 2000mm.
- Peso máximo 200kg.
- Espessura do vidro 10-13mm.
- Patente internacional.
- Sistema de ajuste da posição da porta
↖ ±3mm | ↘ ±3mm / 4° ▷ (consultar dt*)

**HYDRAULIC PIVOT
SET FOR GLASS DOORS.**

- Closing speed with valve regulation.
- Application in the pavement surface without masonry work
- Max. door width 2000mm.
- Max. weight up to 200kg.
- Glass thickness 10-13mm.
- International patent.
- System for door position adjustment
↖ ±3mm | ↘ ±3mm / 4° ▷ (consult dw*)

**JUEGO COMPLETO DE PIVOTE
HIDRÁULICO PARA PUERTAS DE CRISTAL.**

- Velocidade de cierre regulable por válvula.
- Aplicación en la superficie del pavimento sin trabajos de albañilería.
- Anchura máx. de la puerta 2000mm.
- Peso máx. 200kg.
- Espesor del cristal 10-13mm.
- Patente Internacional.
- Sistema para ajustar la posición de puerta
↖ ±3mm | ↘ ±3mm / 4° ▷ (ver dibujo*)



IN.81.206.TB
EN 1.4301 + Titanium Black



IN.81.206.TG
EN 1.4301 + Titanium gold



IN.81.206.TCO
EN 1.4301 + Titanium copper



IN.81.206.TCH
EN 1.4301 + Titanium chocolate

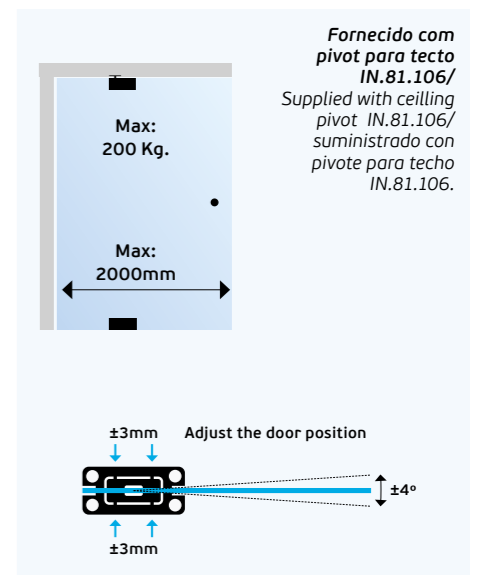
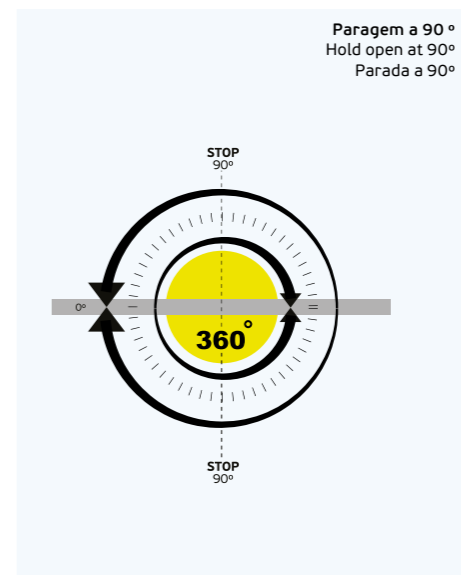
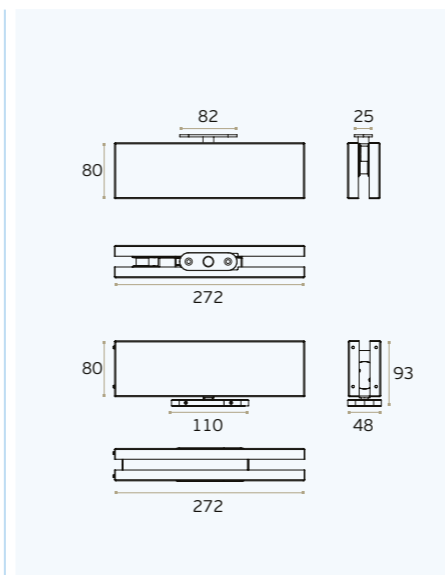

H System

SISTEMAS PIVOTANTES PARA VIDRO /
PIVOTS SYSTEMS FOR GLASS /
SISTEMAS DE PIVOTE PARA CRISTAL.

SISTEMA PIVOTANTE PARA
PORTAS DE VIDRO DE ACÇÃO
SIMPLES OU DUPLA. INDICADO
PARA PORTAS DE GRANDES
DIMENSÕES, ATÉ 200KG.
ESPESSURAS DE VIDRO
DE 8 A 16MM.

PIVOT SYSTEM FOR GLASS
DOORS. SUITABLE FOR SINGLE
AND DOUBLE ACTION DOORS.
RECOMENDED FOR BIG SIZE
DOORS UNTIL 200KG. GLASS
THICKNESS FROM 8 TO 16MM.

SISTEMA PIVOTANTE PARA
PUERTAS DE CRISTAL DE ACCIÓN
SIMPLES Ó DOBLE. INDICADO
PARA PUERTAS DE GRANDES
DIMENSIONES, HASTA 200KG.
ESPESOR DE CRISTAL DE 8
HASTA 16MM.

MODELO
PATENTEADO.
PATENTED MODEL.
MODELO PATENTADO.

DESIGN:
MIGUEL VASCONCELOS

**IN.81.350**

Conjunto de pivot superior,
intermédio e inferior para
portas de vidro. Fornecido com 2
tubos intermédios para máx. de
2600mm de altura. Podem ser
cortados. Pode ser aplicado numa
mola ou num giro de pavimento /

Upper, medium and bottom pivot
set for glass doors. Supplied with 2
middle tubes for maximum 2600mm
height. Can be cutted. Can work with
a floor closer or a floor pivot /

Conjunto de pivote superior
intermedio y inferior para puerta de
cristal. Suministrado con 2 barras
para una altura máxima de 2600mm.
Pueden ser cortadas. Puede funcionar
con un cierra puertas de suelo
o con un pivote de suelo.

IN.81.350.3000

Conjunto para altura máx.
de 3000mm /

Set for maximum 3000mm height /
Conjunto para una altura máxima
de 3000mm.

IN.81.350.4000

Conjunto para altura máx.
de 4000mm /

Set for maximum 4000mm height /
Conjunto para una altura máxima
de 4000mm.



MATERIAL: EN 1.4301 / AISI 304

ACABAMENTO / FINISH / ACABADO:
STANDARD: SATINADO / SATIN / SATIN

ESPESSURAS DE VIDRO
GLASS THICKNESS /
ESPESOR DEL CRISTAL

	Kg por m2
8 mm	20 kg
10 mm	25 kg
12 mm	30 kg
14 mm	35 kg
16 mm	40 kg

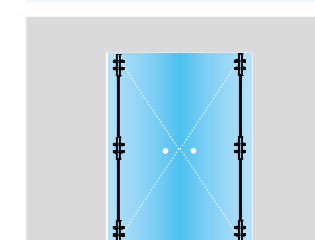
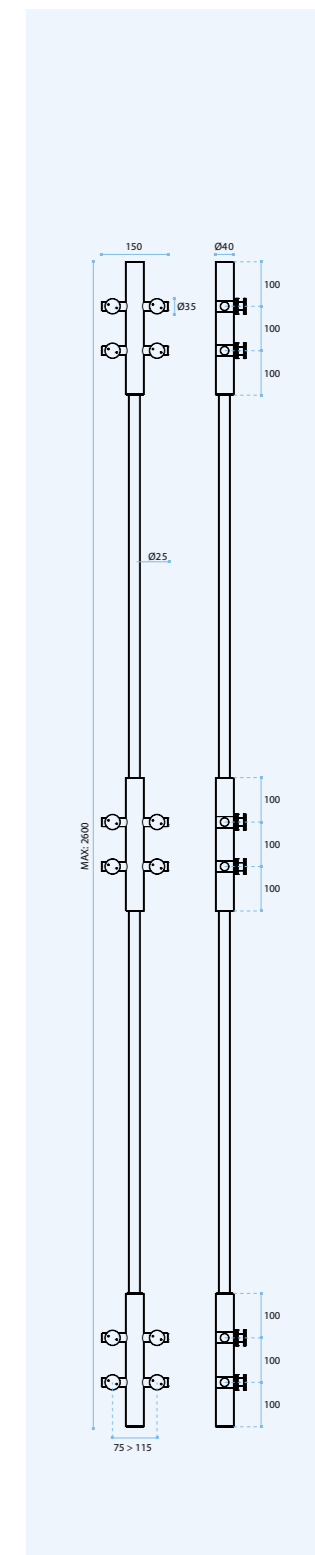

H System

SISTEMAS PIVOTANTES PARA VIDRO /
PIVOTS SYSTEMS FOR GLASS /
SISTEMAS DE PIVOTE PARA CRISTAL.**IN.81.352**

Pivot para painel de
vidro superior /
Overpanel pivot for glass /
Pivote para cristal superior.

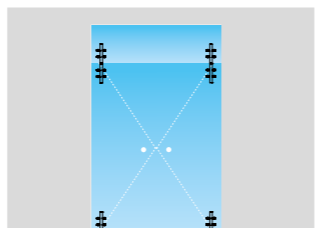
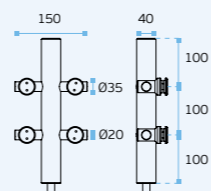
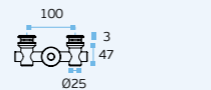

MATERIAL: EN 1.4301 / AISI 304

ACABAMENTO / FINISH / ACABADO:
STANDARD: SATINADO / SATIN / SATIN

OPTIONAL: PVD TITANIUM COATED

.TB / .TG / .TCO / .TCH



IN.81.352.TB
EN 1.4301 + Titanium Black

IN.81.351

Conjunto de pivot superior e
inferior para portas de vidro.
Pode ser aplicado numa mola ou
num giro de pavimento /
Upper and bottom pivot set for
glass doors. Can be fitted with
a floor closer or a floor pivot /
Conjunto de pivote superior y
inferior para puerta de cristal.
Puede funcionar con un cierre
puertas de suelo o con un pivote
de suelo.

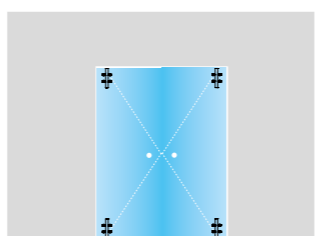
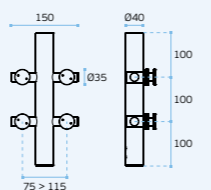
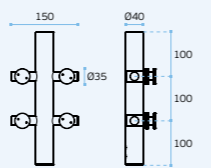

MATERIAL: EN 1.4301 / AISI 304

ACABAMENTO / FINISH / ACABADO:
STANDARD: SATINADO / SATIN / SATIN

OPTIONAL: PVD TITANIUM COATED

.TB / .TG / .TCO / .TCH



IN.81.351.TB
EN 1.4301 + Titanium black

**H
SYSTEM
FOR
GLASS**

**SISTEMA PIVOTANTE PARA PORTAS
DE VIDRO DE ACÇÃO SIMPLES OU
DUPLA. INDICADO PARA PORTAS DE
GRANDES DIMENSÕES, ATÉ 200KG /
PIVOT SYSTEM FOR GLASS DOORS.
SUITABLE FOR SINGLE AND DOUBLE
ACTION DOORS. RECOMMENDED FOR BIG
SIZE DOORS UNTIL 200KG /
SISTEMA PIVOTANTE PARA PUERTAS DE
CRISTAL DE ACCIÓN SIMPLES O DOBLE.
INDICADO PARA PUERTAS DE GRANDES
DIMENSIONES, HASTA 200KG.**

H2 System

SISTEMAS PIVOTANTES PARA VIDRO /
PIVOTS SYSTEMS FOR GLASS /
SISTEMAS DE PIVOTE PARA CRISTAL.

H2 SYSTEM FOR GLASS

**O SISTEMA H2 PARA PORTAS DE
VIDRO É SEGURO, FUNCIONAL
E COM DESENHO SIMPLES /**
THE UNIQUE H2 SYSTEM FOR GLASS
DOORS IS SAFE, FUNCTIONAL
AND SIMPLE DESIGN /
EL SISTEMA H2 PARA PUERTAS DE
CRISTAL ES SEGURO, FUNCIONAL
Y DE DISEÑO SENCILLO.

MODELO PATENTEADO.
PATENTED MODEL.
MODELO PATENTADO.
DESIGN: MIGUEL VASCONCELOS

H2 System

SISTEMAS PIVOTANTES PARA VIDRO /
PIVOTS SYSTEMS FOR GLASS /
SISTEMAS DE PIVOTE PARA CRISTAL.
IN.81.250

Conjunto de pivot superior e inferior para portas de vidro. Pode ser aplicado numa mola ou num giro de pavimento /

Upper and bottom pivot kit for glass doors. Can work with a floor closer or a floor pivot / Conjunto de pivote superior y inferior para cristal. Puede funcionar con un cierre puertas de suelo o con un pivote de suelo.

.TB .TG .TCO .TCH



MATERIAL: EN 1.4301 / AISI 304

ACABAMENTO / FINISH / ACABADO:
STANDARD: SATINADO / SATIN / SATIN

OPTIONAL: PVD TITANIUM COATED

.TB / .TG / .TCO / .TCH

IN.81.250.TB
EN 1.4301 + Titanium Black

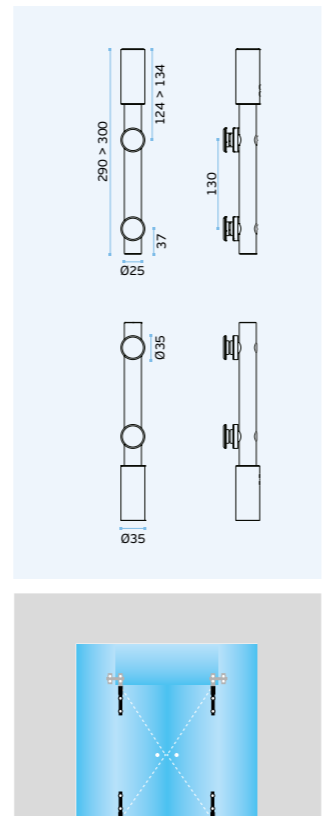

O sistema H2 para portas de vidro é seguro, funcional e com desenho simples. Este sistema foi pensado para ser leve e simples, permitindo aproveitar toda a transparência do vidro.

O sistema H2 permite instalar em portas de vidro de batente ou dupla ação sem moldura em vidro temperado. Peças produzidas em aço inoxidável com diferentes acabamentos disponíveis, satinado, polido e PVD Titanium em preto, dourado, cobre e chocolate.

Tecnicamente este pivot foi desenvolvido com sistema de regulação rápida em altura e a fixação ao vidro só é acessível pelo interior, garantindo alta segurança.

The unique H2 system for glass doors is safe, functional and simple design. This system was designed to be clear and simple, allowing to use the full transparency of the glass.

H2 system enables to build frameless swing glass doors into tempered glass assemblies, made in stainless steel with different finished available, satin, mirror and PVD finishes black, gold, cooper and chocolate.

Technically this pivot was developed with easy high adjustment system and the fixing to the glass is only accessible from the inside, ensuring high security.

El sistema H2 para puertas de cristal es seguro, funcional y de diseño sencillo. Este sistema fue diseñado para ser ligero y simple, permitiéndole aprovechar toda la transparencia del vidrio.

El sistema H2 permite instalar en puertas de vidrio de batiente o doble acción sin marco en vidrio templado, piezas fabricadas en acero inoxidable con diferentes acabados disponibles, satinado, pulido y PVD Titanio en negro, oro, cobre y encolado.

Tecnicamente, este pivote fue desarrollado con un sistema de ajuste rápido de altura y la fijación al vidrio solo es accesible desde el interior, lo que garantiza una alta seguridad.

IN.81.251

Conjunto de pivot superior e inferior para portas de vidro. Pode ser aplicado numa mola ou num giro de pavimento /

Upper and bottom pivot set for glass doors. Can be fitted with a floor closer or a floor pivot / Conjunto de pivote superior y inferior para puerta de cristal. Puede funcionar con un cierre puertas de suelo o con un pivote de suelo.

Altura máxima da porta: /
Max door height: /
Altura máxima de la puerta:
2600mm

.TB .TG .TCO .TCH



MATERIAL: EN 1.4301 / AISI 304

ACABAMENTO / FINISH / ACABADO:
STANDARD: SATINADO / SATIN / SATIN

OPTIONAL: PVD TITANIUM COATED

.TB / .TG / .TCO / .TCH

IN.81.251.TB
EN 1.4301 + Titanium Black

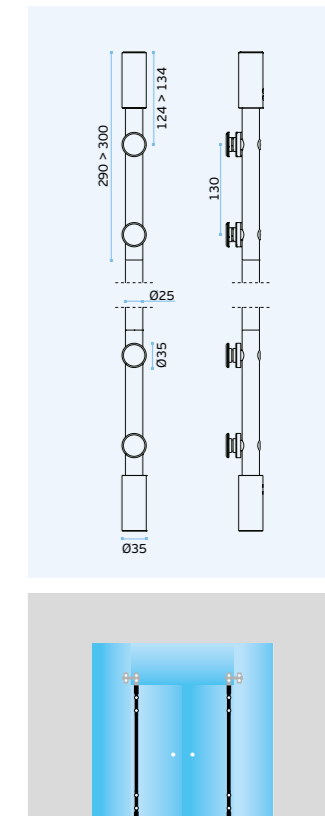
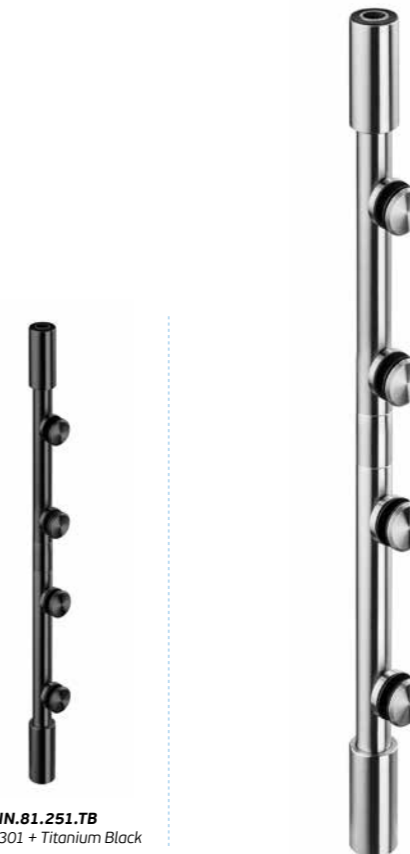
**IN.80.460**

Suporte de vidro ajustável. /
Adjustable glass support. /
Soporte cristal ajustable /

.TB .TG .TCO .TCH



MATERIAL: EN 1.4301 / AISI 304

ACABAMENTO / FINISH / ACABADO:
STANDARD: SATINADO / SATIN / SATIN

OPTIONAL: PVD TITANIUM COATED

.TB / .TG / .TCO / .TCH

IN.80.460.TB
EN 1.4301 + Titanium black

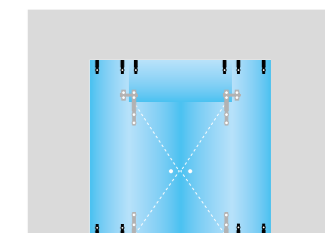
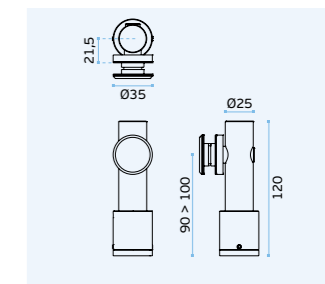

H2 System

SISTEMAS PIVOTANTES PARA VIDRO /
PIVOTS SYSTEMS FOR GLASS /
SISTEMAS DE PIVOTE PARA CRISTAL.
IN.81.252
Pivot para painel de vidro superior com suporte lateral à parede.
Reversível / Overpanel pivot for glass with wall fixing. Reversible /
 Pivote para cristal superior y fijación a la pared lateral. Reversible.

 GC73
 glass cut

MATERIAL: EN 1.4301 / AISI 304

ACABAMENTO / FINISH / ACABADO:
STANDARD: SATINADO / SATIN / SATIN

OPTIONAL: PVD TITANIUM COATED

.TB / .TG / .TCO

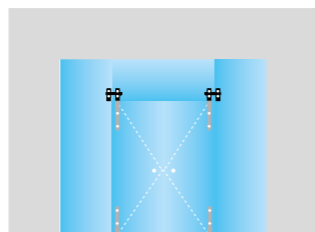
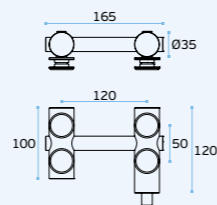
IN.81.252.TB
 EN 1.4301 + Titanium black
**IN.81.254**
Pivot para painel de vidro superior /
Overpanel pivot for glass /
Pivote para cristal superior.

 GC75
 glass cut

MATERIAL: EN 1.4301 / AISI 304

ACABAMENTO / FINISH / ACABADO:
STANDARD: SATINADO / SATIN / SATIN

OPTIONAL: PVD TITANIUM COATED

.TB / .TG / .TCO / .TCH

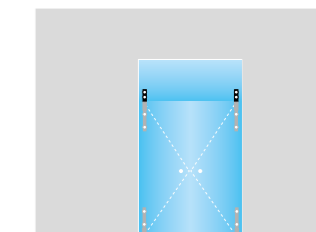
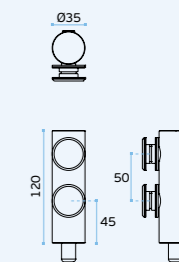
IN.81.254.TB
 EN 1.4301 + Titanium black
**IN.81.253**
Pivot para painel de vidro superior com suporte lateral à parede.
Reversível / Overpanel pivot for glass with wall fixing. Reversible. /
 Pivote para cristal superior y fijación a la pared lateral. Reversible.

 GC74
 glass cut

MATERIAL: EN 1.4301 / AISI 304

ACABAMENTO / FINISH / ACABADO:
STANDARD: SATINADO / SATIN / SATIN

OPTIONAL: PVD TITANIUM COATED

.TB / .TG / .TCO

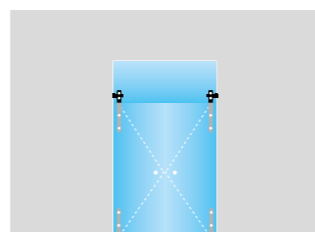
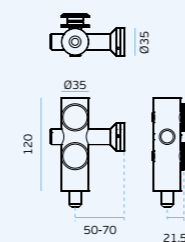
IN.81.253.TB
 EN 1.4301 + Titanium black
**IN.81.255**
Fixação superior e lateral com batente. Reversível /
Over and side panel with stopper. Reversible /
Fijación superior y lateral con tope. Reversible.

 GC76
 glass cut

MATERIAL: EN 1.4301 / AISI 304

ACABAMENTO / FINISH / ACABADO:
STANDARD: SATINADO / SATIN / SATIN

OPTIONAL: PVD TITANIUM COATED

.TB / .TG / .TCO / .TCH

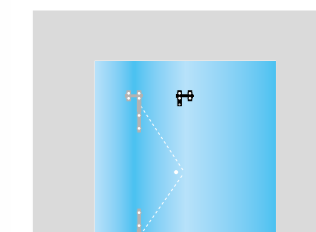
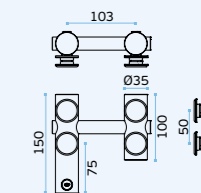
IN.81.255.TB
 EN 1.4301 + Titanium Black
**IN.81.256**
Fixação superior e lateral. Reversível /
Over and side panel. Reversible /
Fijación superior y lateral para cristal. Reversible.

 GC77
 glass cut

MATERIAL: EN 1.4301 / AISI 304

ACABAMENTO / FINISH / ACABADO:
STANDARD: SATINADO / SATIN / SATIN

OPTIONAL: PVD TITANIUM COATED

.TB / .TG / .TCO / .TCH

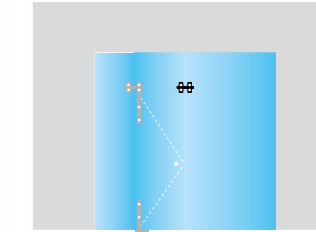
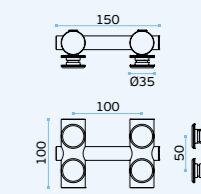
IN.81.256.TB
 EN 1.4301 + Titanium Black

H2 System

SISTEMAS PIVOTANTES PARA VIDRO / PIVOTS SYSTEMS FOR GLASS / SISTEMAS DE PIVOTE PARA CRISTAL.



NEW

IN.81.261.500
IN.81.261.1000
IN.81.261.1500*
Fecho para portas de vidro /
Latch for glass doors /
Cerradura para puertas en cristal.

*Acabamento Titânio PVD até 1000mm /
PVD Titanium finish until 1000mm /
Acabamiento en PVD Titano ate 1000mm

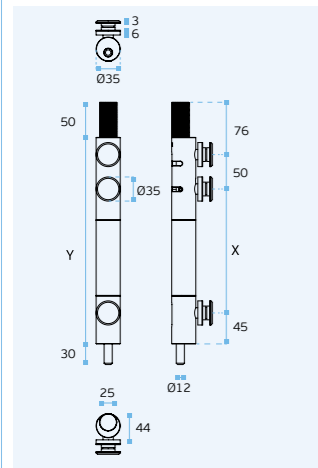

.TB .TG .TCO .TCH

GC118 glass cut 10-12 mm

MATERIAL: EN 1.4301 / AISI 304
ACABAMENTO / FINISH / ACABADO: STANDARD: SATINADO / SATIN / SATIN
OPTIONAL: PVD TITANIUM COATED
.TB / .TG / .TCO / .TCH

	500	1000	1500
X	380	880	1380
Y	500	1000	1500



NEW

IN.81.260
Fecho para portas de vidro /
Cerradura para puertas en cristal /
Latch for glass doors.

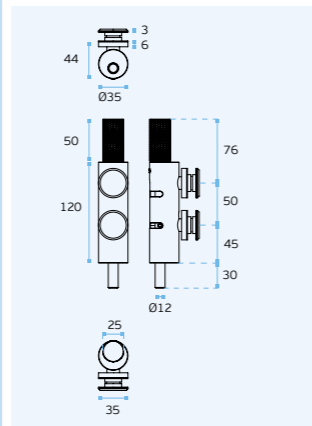

.TB .TG .TCO .TCH

GC117 glass cut 10-12 mm

MATERIAL: EN 1.4301 / AISI 304
ACABAMENTO / FINISH / ACABADO: STANDARD: SATINADO / SATIN / SATIN
OPTIONAL: PVD TITANIUM COATED
.TB / .TG / .TCO / .TCH

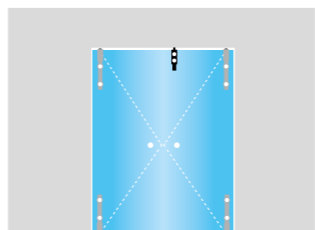

NEW

IN.81.262
Receptor de fecho vidro - vidro
Closing receiver glass - glass /
Receptor de cierre cristal - cristal.

GC75 glass cut 10-12 mm .TB .TG .TCO .TCH

MATERIAL: EN 1.4301 / AISI 304
ACABAMENTO / FINISH / ACABADO: STANDARD: SATINADO / SATIN / SATIN
OPTIONAL: PVD TITANIUM COATED
.TB / .TG / .TCO / .TCH

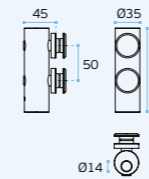

NEW

IN.81.263
Receptor de fecho vidro - parede
Closing receiver glass - wall /
Receptor de cierre cristal - pared.

GC74 glass cut 10-12 mm .TB .TG .TCO .TCH

MATERIAL: EN 1.4301 / AISI 304
ACABAMENTO / FINISH / ACABADO: STANDARD: SATINADO / SATIN / SATIN
OPTIONAL: PVD TITANIUM COATED
.TB / .TG / .TCO / .TCH

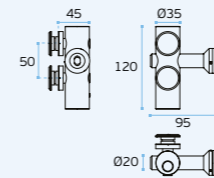

NEW

IN.81.264
Receptor de fecho vidro - vidro
Closing receiver glass - glass /
Receptor de cierre cristal - cristal.

GC73 glass cut 10-12 mm .TB .TG .TCO .TCH

MATERIAL: EN 1.4301 / AISI 304
ACABAMENTO / FINISH / ACABADO: STANDARD: SATINADO / SATIN / SATIN
OPTIONAL: PVD TITANIUM COATED
.TB / .TG / .TCO / .TCH

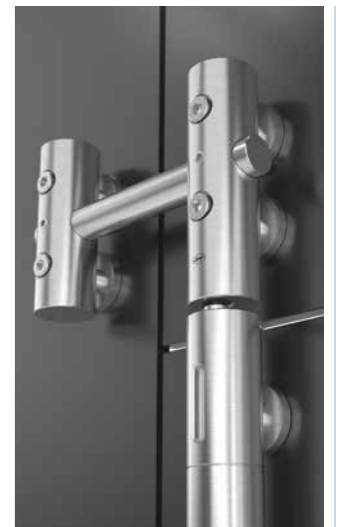
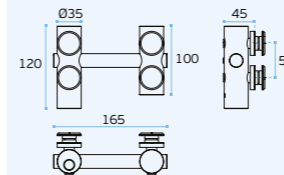

W System

DOBRADIÇAS HIDRÁULICAS PARA VIDRO / HYDRAULIC HINGES FOR GLASS / BISAGRAS HIDRAULICAS PARA CRISTAL.



IN.05.322

Conjunto de duas dobradiças hidráulicas, parede - vidro / Set of two hydraulic glass to wall hinges / Juego de dos bisagras hidráulicas pared - cristal.



MATERIAL: EN 1.4301 / AISI 304

ACABAMENTO / FINISH / ACABADO: STANDARD: SATINADO / SATIN / SATIN

OPTIONAL: PVD TITANIUM COATED

.TB / .TG / .TCO / .TCH

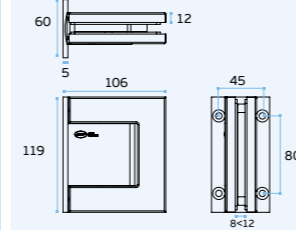

- Velocidade de fecho regulável por válvula
- Largura da porta: 1000mm (máx.)
- Peso: 100kg (máx.)
- Espessura do vidro: 8-12,7mm
- Patente internacional

- Closing speed adjustable by valve
- Door width: 1000mm (max.)
- Weight: up to 100kg (max.)
- Glass thickness: 8-12,7mm
- International patent

- Velocidad de cierre regulable por válvula
- Ancho de la puerta: 1000 mm (máx.)
- Peso: 100 kg (máx.)
- Espesor del vidrio: 8-12,7 mm
- Patente internacional



HYDRAULIC SYSTEM

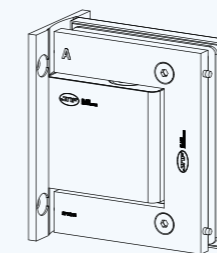

A - Dobradiça com mola / Spring hinge / Bisagra con muelle

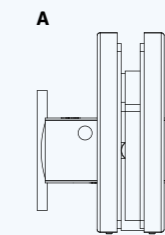

Ajuste da velocidade de fecho / Closing speed adjustment / Ajuste de la velocidad de cierre.

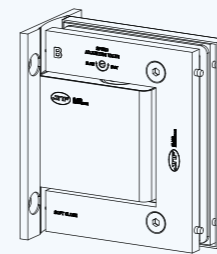

B - Dobradiça com amortecedor / Soft close hinge / Bisagra con amortiguador

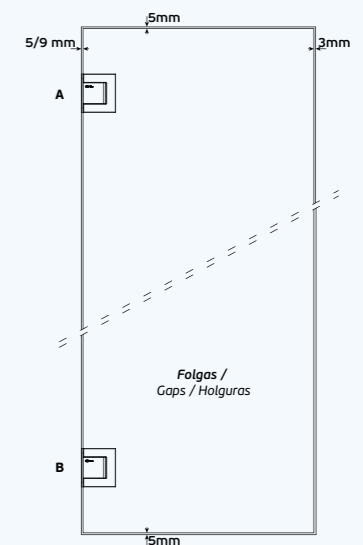
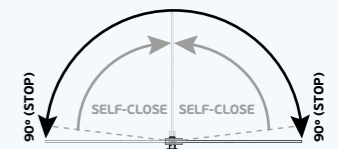
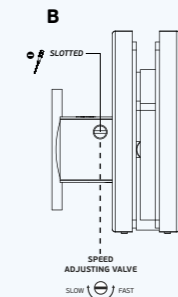

W System

DOBRADIÇAS HIDRÁULICAS PARA VIDRO /
HYDRAULIC HINGES FOR GLASS /
BISAGRAS HIDRAULICAS PARA CRISTAL.

IN.05.322
Satinado / Satin / Satin

IN.05.322.P
Polido / Polished / Pulido

IN.05.322.TB
PVD TITANIUM Black

IN.05.322.TG
PVD TITANIUM Gold

IN.05.322.TCO
PVD TITANIUM Copper

IN.05.322.TCH
PVD TITANIUM Chocolate

W SYSTEM HYDRAULIC HINGE FOR GLASS

CONJUNTO DE DUAS DOBRADIÇAS
HIDRÁULICAS PARA PORTAS DE VIDRO /
HYDRAULIC HINGE SET FOR GLASS DOORS /
JUEGO DE DOS BISAGRAS HIDRÁULICAS
PARA PUERTAS DE CRISTAL.

 Imagem / Image :
 IN.05.322.TG

**CONJUNTO DE DUAS DOBRADIÇAS
HIDRÁULICAS, PAREDE - VIDRO**

- Velocidade de fecho regulável por válvula
- Retenção a 90°
- Largura da porta: 1000mm (máx.)
- Peso: 100kg (máx.)
- Espessura do vidro: 8-12,7mm
- Patente internacional
- 500.000 Ciclos
- Tampas em Aço inoxidável AISI 304
- Possibilidade em acabamentos PVD TITANIUM

**SET OF TWO HYDRAULIC
GLASS TO WALL HINGES**

- Closing speed adjustable by valve
- 90° retention
- Door width: 1000mm (max.)
- Weight: up to 100kg (max.)
- Glass thickness: 8-12,7mm
- International patent
- 500,000 Cycles
- Covers in AISI 304 stainless steel
- Possibility in finishes PVD TITANIUM

**JUEGO DE DOS BISAGRAS
HIDRÁULICAS PARED - CRISTAL.**

- Velocidad de cierre regulable por válvula
- Retención de 90°
- Ancho de la puerta: 1000 mm (máx.)
- Peso: 100 kg (máx.)
- Espesor del vidrio: 8-12,7 mm
- Patente internacional
- 500.000 Ciclos
- Tapas en acero inoxidable AISI 304
- Posibilidad en acabados PVD TITANIO



DOBRADIÇAS PARA VIDRO /
HINGES FOR GLASS /
BISAGRAS PARA CRISTAL.**IN.05.313****Dobradiça parede-vidro /**
Wall to glass hinge /
Bisagra pared-cristal.

.TB .TG .TCO .TCH

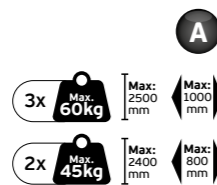
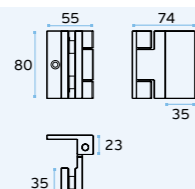
**MATERIAL:** EN 1.4301 / AISI 304**ACABAMENTO / FINISH / ACABADO:**
STANDARD: SATINADO / SATIN / SATIN**OPTIONAL:** PVD TITANIUM COATEDGC26
glass cut**IN.05.312****Dobradiça vidro-vidro /**
Glass to glass hinge /
Bisagra cristal-cristal.

.TB .TG .TCO .TCH

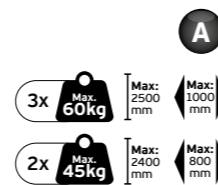
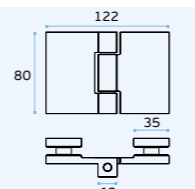
**MATERIAL:** EN 1.4301 / AISI 304**ACABAMENTO / FINISH / ACABADO:**
STANDARD: SATINADO / SATIN / SATIN**OPTIONAL:** PVD TITANIUM COATEDGC25
glass cut**IN.27.009****Dobradiça parede - vidro /**
Wall to glass hinge /
Bisagra pared - cristal.

.TB .TG .TCO .TCH

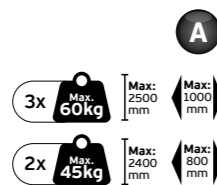
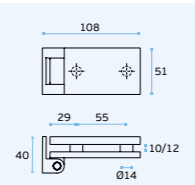
**MATERIAL:** EN 1.4301 / AISI 304**ACABAMENTO / FINISH / ACABADO:**
STANDARD: SATINADO / SATIN / SATIN**OPTIONAL:** PVD TITANIUM COATEDGC21
glass cut**IN.27.001****Dobradiça vidro - vidro /**
Glass to glass hinge /
Bisagra cristal - cristal.

.TB .TG .TCO .TCH

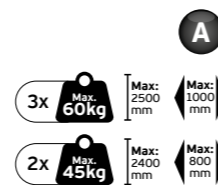
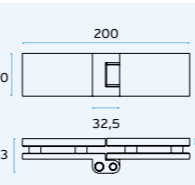
**MATERIAL:** EN 1.4301 / AISI 304**ACABAMENTO / FINISH / ACABADO:**
STANDARD: SATINADO / SATIN / SATIN**OPTIONAL:** PVD TITANIUM COATEDGC20
glass cutIMAGE / IMAGE:
IN.05.312.TB

SOLID STAINLESS STEEL GLASS HINGES

Dobradiças em aço inoxidável maciças.
Um robusto eixo garante o perfeito funcionamento de portas até 60kg com altura até aos 2,5Mt.

O sistema de rolamentos poliméricos, garante um funcionamento suave e grande resistência à fadiga.

Estas dobradiças podem ter acabamentos pvd titanium nas cores: preto, dourado, cobre e chocolate além do standard satinado.

Solid stainless steel hinges.
A robust shaft ensures the perfect operation of doors up to 60kg with height up to 2,5Mt.

The polymer bearing system guarantees smooth operation and great resistance to fatigue.

These hinges can have pvd titanium finishes in the colors: black, gold, copper and chocolate in addition to the standard satin.

Bisagras de acero inoxidable macizo.
Un robusto eje garantiza el perfecto funcionamiento de puertas hasta 60kg con una altura de hasta 2,5Mt.

El sistema de rodamientos de polímero garantiza un funcionamiento suave y una gran resistencia a la fatiga.

Estas bisagras pueden tener acabados pvd de titanio en los colores: negro, dorado, cobre y chocolate además del estándar satinado.

BARRAS ANTI-PÂNICO PARA PORTAS DE VIDRO /
PANIC EXIT DEVICES FOR GLASS DOORS /
DISPOSITIVOS ANTIPÁNICO PARA PUERTAS DE CRISTAL.



A SÉRIE DE BARRAS ANTI-PÂNICO JNF PERMITE SOLUCIONAR QUASE TODAS AS SITUAÇÕES, DESDE PORTAS SIMPLES, DUPLAS, DE VIDRO, MADEIRA, METÁLICAS, ETC.

Todas as barras são certificadas de acordo com as normas EN 1125 e possuem marcação CE, padrões que são obrigatórios para todos os dispositivos anti-pânico e/ou de emergência.

As barras são reversíveis, sendo efectuada a troca de uma forma muito rápida e intuitiva. As tampas, barras e tubos são fabricados em aço inoxidável EN 1.4301 com acabamento escovado.

Mecanismos internos são em aço galvanizado. Possibilidade de cortar a barra horizontal. Possibilidade de ajustar 40mm as barras verticais, assim como cortar se necessário. Caixas estreitas com 39mm que permitem aplicar em qualquer perfil de alumínio.

THE JNF PANIC EXIT DEVICES SERIES ALLOWS TO SOLVE ALMOST ALL SITUATIONS FROM SIMPLE TO DOUBLE DOORS, GLASS, WOOD, METAL, ETC.

All the bars are certified according to EN 1125 standards and have CE marking, standards that are mandatory for all the anti-panic and/or emergency devices.

The bars are reversible, and the exchange is very quick and intuitive. Covers, bar and tube are made of stainless steel EN 1.4301 with brushed finish.

Internal mechanisms are made of galvanized steel. Horizontal bar can be cut. The vertical bars can be adjusted 40mm, and cutted if necessary. Narrow boxes with 39mm fit in any aluminum profile.

LA SERIE DE CERRADURAS ANTIPÁNICO PERMITE SOLUCIONAR CASI TODAS LAS SITUACIONES, DE PUERTA SIMPLE O DOBLE, CRISTAL, MADERA, METAL, ETC.

Todos los dispositivos están certificados según las normas EN 1125 y han marcado CE, normas que son obligatorias para todos los anti-pánico y/o dispositivos de emergencia.

Las barras son reversibles, y el cambio es muy rápido e intuitivo. Tapas, brazos y tubos hechas de acero inoxidable EN 1.4301 con acabado satin.

Los mecanismos internos son de acero galvanizado. Se puede cortar la barra horizontal. Las barras verticales se pueden ajustar 40 mm, o cortar se es necesario. Cajas estrechas con 39mm caben en cualquier perfil de aluminio.

PANIC EXIT DEVICES FOR GLASS DOORS

**BARRAS ANTI-PÂNICO EN 1125 /
PANIC EXIT DEVICES EN 1125 /
BARRAS ANTIPANICO EN 1125**

BARRAS ANTI-PÂNICO DE SOBREPOR / RIM PANIC EXIT DEVICES / DISPOSITIVOS ANTIPÁNICO DE SOBREPONER.

IN.20.951.K1

Barra anti-pânico reversível para porta de 1 folha. Fecho através de trinco lateral. Sem funcionamento através do exterior /

Antipanic reversible lock for single doors. Closing system through a side latch. Without access from external side /

Cerradura antipánico reversible para puertas de 1 hoja. Cierre por picaporte basculante lateral. Sin funcionamiento por el exterior.



IN.20.952.K2

Barra anti-pânico reversível para porta de 1 folha. Fecho através de trinco lateral. Abertura por chave através do exterior. Puxador rotativo com placa e cilindro incluídos /

Antipanic reversible lock for single doors. Closing system through a side latch. Opening by key from the outside. Lever handle with plate and cylinder included /

Cerradura antipánico reversible para puertas de 1 hoja. Cierre por picaporte basculante lateral. Apertura por llave por el exterior. Manilla, placa y cilindro incluidos.

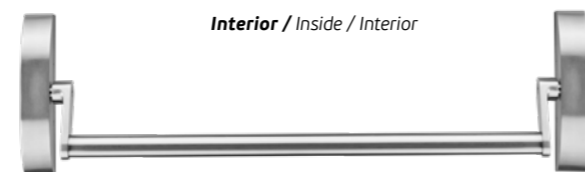

Exterior / Outside / Exterior

Interior / Inside / Interior



MATERIAL: EN 1.4301 / AISI 304

ACABAMENTO / FINISH / ACABADO: SATINADO / SATIN / SATIN

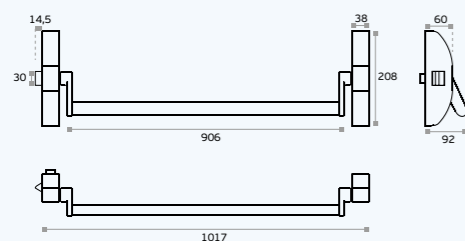

MATERIAL: EN 1.4301 / AISI 304

ACABAMENTO / FINISH / ACABADO: SATINADO / SATIN / SATIN

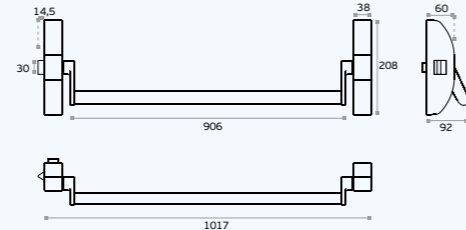

PANIC EXIT DEVICES FOR GLASS DOORS

BARRAS ANTI-PÂNICO EN 1125 /
 PANIC EXIT DEVICES EN 1125 /
 BARRAS ANTIPANICO EN 1125

BARRAS ANTI-PÂNICO DE SOBREPOR / RIM PANIC EXIT DEVICES / DISPOSITIVOS ANTIPÁNICO DE SOBREPONER.

IN.20.953.K3

Barra anti-pânico reversível com fecho através de trinco superior e inferior. Sem funcionamento pelo exterior /

Antipanic lock with closing system through top and down bolts. Without function from the outside /

Cerradura antipánico con cierre por picaporte alto y bajo. Sin funcionamiento por lo exterior.



IN.20.954.K4

Barra anti-pânico reversível com fecho através de trinco superior e inferior. Abertura por chave ou puxador através do exterior. Puxador com placa e cilindro incluídos /

Antipanic lock with closing system through top and down bolts. Opening by key and lever handle from the outside. Lever handle with plate and cylinder included /

Cerradura antipánico con cierre por picaporte alto y bajo. Apertura por llave y manilla por el exterior. Manilla, placa y cilindro inclusos.



Exterior / Outside / Exterior

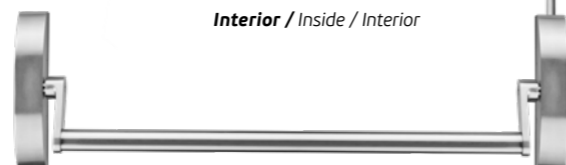

Interior / Inside / Interior

MATERIAL: EN 1.4301 / AISI 304

ACABAMENTO / FINISH / ACABADO: SATINADO / SATIN

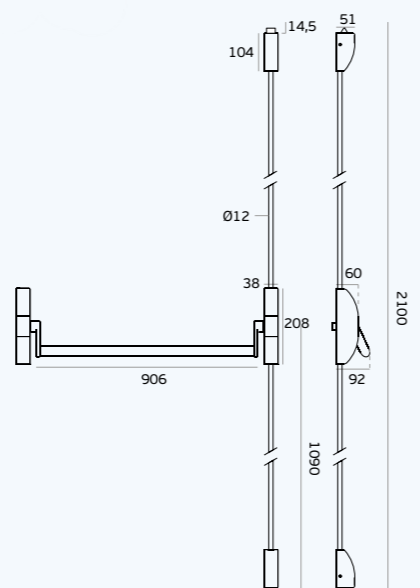

3 7 6 0 1 3 2 2 A

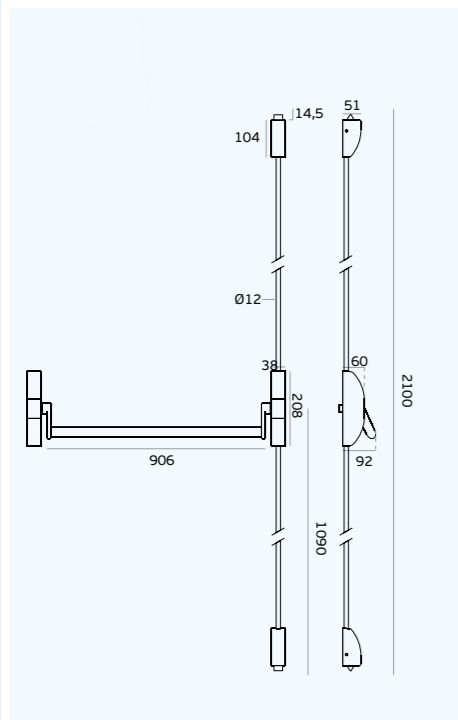

3 7 6 0 1 3 2 2 A



ACESSÓRIOS PARA BARRAS ANTI-PÂNICO / PANIC EXIT DEVICES ACCESSORIES / ACCESORIOS PARA BARRAS ANTIPANICO.

IN.20.950

Placa com puxador
e cilindro Compatível com:
IN.20.951 / IN.20.953

Plate with handle and cylinder
suitable for:
IN.20.951 / IN.20.953

Placa con manilla y cilindro
compatible con:
IN.20.951 / IN.20.953

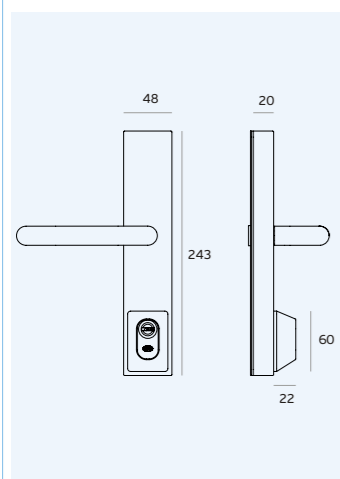

Caixa interior fechada e reforçada /
Closed and reinforced inner body /
Caja interior cerrada y reforzada

Sistema reversível para puxador e cilindro /
Reversible system for lever handle and cylinder /
Sistema reversible para manilla y cilindro

Modelo de puxador pode ser trocado /
Lever handle model can be changed /
Modelo de manilla puede ser cambiada.

Proteção de cilindro sólida /
Solid cylinder protection /
Protección de cilindro robusta.

Acessórios disponíveis para aplicação
em portas de vidro / Available accessories to
install in glass doors / Accesorios disponibles
para instalar en puertas de cristal

Tampa aço inoxidável EN 1.4301 /
Stainless steel EN 1.4301 cover /
Cubierta en acero inoxidable EN 1.4301.

Meio cilindro europeu de segurança. Pode ser
aplicado qualquer modelo de cilindro europeu
10x30mm. Permite planos de mestragem ou
grupos de chaves iguais / Security half European
cylinder. Can be installed any model of European
cylinder 10x30mm. Allows master key plans or
keys alike groups / Medio cilindro Europeo de
Seguridad. Se puede aplicar cualquier modelo de
cilindro Europeo 10x30mm. Permite planos de
amastramiento o grupos de llaves igualadas /

IN.19.S40.10.30

Cilindro Compatível com: IN.20.950 /
Cylinder suitable for: IN.20.950 /
Cilindro compatible con: IN.20.950 /

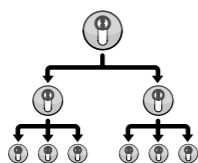

IN.19.S40.10.30.MST

Sistema de mestragem
(anexar plano de mestragem) /
Master key system
(Attach master key plan) /
Mestramiento
(añadir plan de maestramiento)

IN.19.S11.10.30

Cilindro Compatível com: IN.20.950 /
Cylinder suitable for: IN.20.950 /
Cilindro compatible con: IN.20.950 /

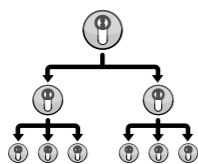

IN.19.S11.10.30.MST

Sistema de mestragem
(anexar plano de mestragem) /
Master key system
(Attach master key plan) /
Mestramiento
(añadir plan de maestramiento)

3 7 6 1 1 3 2 2 A

IN.20.962

Trancas verticais
para portas superior
a 2200mm até
3140mm. Aplicável
com IN.20.953/954 /
Vertical rods for doors
higher than 2200 mm.
until 3140mm.
Applicable with
IN.20.953/954 /
Fallebas para puertas
superiores a 2200
mm hasta 3140mm.
Aplicable con
IN.20.953/954.

IN.20.961

Barra de apoio horizontal
oval com 1400mm / Oval
shaped horizontal bar with
1400mm /
Barra horizontal ovalada
con 1400mm /



DECLARAÇÃO DE DESEMPENHO / MARCAÇÃO CE DECLARATION OF PERFORMANCE (DOP) / CE MARKING/ DECLARACIÓN DE PRESTACIONES / MARCADO CE

O Regulamento (UE) n.º 305/2011 entrou em vigor em 1 de
Julho de 2013, o qual estabelece condições harmonizadas
para a comercialização dos produtos de construção e
revoga a Directiva 89/106/CEE.

O presente regulamento obriga os fabricantes de produtos
de construção a elaborar uma declaração de desempenho
quando um produto de construção abrangido por uma
norma harmonizada ou conforme com uma Avaliação Técnica
Europeia emitida para esse produto.

Ao fazer a declaração de desempenho, o fabricante assume
a responsabilidade legal pela conformidade
do produto de construção com o desempenho declarado.

As barras anti-pânico só podem apresentar a marcação
CE quando as mesmas têm utilização prevista em portas
em caminhos de evacuação. Neste caso deve-se seguir o
Sistema 1 de avaliação e verificação da regularidade do
desempenho. Norma harmonizada para fechaduras: EN1125
- Dispositivos de fecho anti-pânico para saídas de emergência
acionados por uma barra horizontal

The Regulation (EU) No 305/2011 entered into force on July 1,
2013, laying down harmonised conditions for the marketing of
construction products and repealing Council Directive 89/106/
EEC.

This regulation requires manufacturers of construction products
to draw up a declaration of performance when a construction
product covered by a harmonised standard, or complies with an
European Technical Assessment issued for this product.

Making a declaration of performance, the manufacturer assumes
legal responsibility for the conformity of the product with the
declared performance.

The antipanic lock must have the CE marking when they have an
intended use for doors on escape route.
In this case should follow the System 1 of assessment and
verification of constancy of performance. Harmonised Standard
for locks: EN1125 - Panic exit devices operated by a horizontal
bar.

El Reglamento (UE) nº 305/2011 entró en vigor en 1 Julio 2013,
que establece condiciones armonizadas para la comercialización
de los productos de construcción y se deroga la Directiva 89/106
/ CEE.

Esta regulación exige a los fabricantes de productos de
construcción a elaborar una declaración de prestaciones cuando
un producto de construcción cubierto por una norma armonizada,
o cumple con una evaluación técnica europea emitida para este
producto.

Hacer una declaración de prestaciones, el fabricante asume la
responsabilidad legal de la conformidad del producto con las
prestaciones declaradas.

La cerradura antipánico debe tener el marcado CE cuando tienen
un uso previsto para puertas en ruta de escape. En este caso, debe
seguir el Sistema 1 de evaluación y verificación de la constancia
de las prestaciones. Norma armonizada para cerraduras: EN1125
- Dispositivos antipánico para salidas de emergencia accionadas
por una barra horizontal.

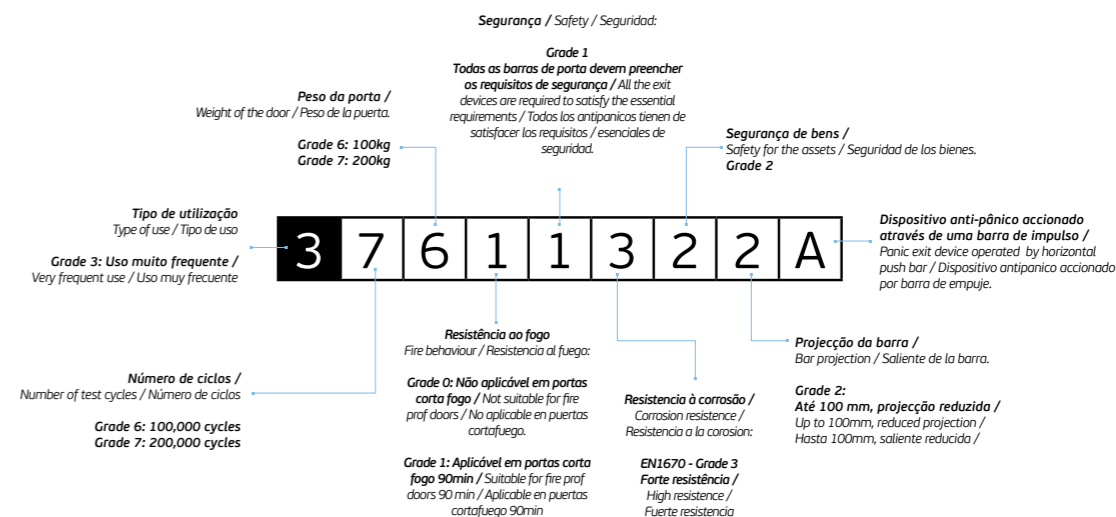

1. Acessórios disponíveis para aplicação em portas de
vidro / Available accessories to install in glass doors /
Accesorios disponibles para instalar en puertas de cristal

2. Caixa interior fechada e reforçada /
Closed and reinforced inner body /
Caja interior cerrada y reforzada

3. Tampa aço inoxidável EN 1.4301 /
Stainless steel EN 1.4301 cover /
Cubierta en acero inoxidable EN 1.4301.

4. Sistema reversível para puxador e cilindro /
Reversible system for lever handle and cylinder /
Sistema reversible para manilla y cilindro

5. Modelo de puxador pode ser trocado /
Lever handle model can be changed /
Modelo de manilla puede ser cambiado

6. Meio cilindro europeu de segurança. Pode ser aplicado
qualquer modelo de cilindro europeu 10x30mm. Permite
planos de mestragem ou grupos de chaves iguais / Security
half European cylinder. Can be installed any model of European
cylinder 10x30mm. Allows master key plans or keys alike
groups / Medio cilindro Europeo de Seguridad. Se puede aplicar
cualquier modelo de cilindro Europeo 10x30mm. Permite planos
amastramiento o grupos de llaves igualadas /

7. Proteção de cilindro sólida /
Solid cylinder protection /
Protección de cilindro robusta.

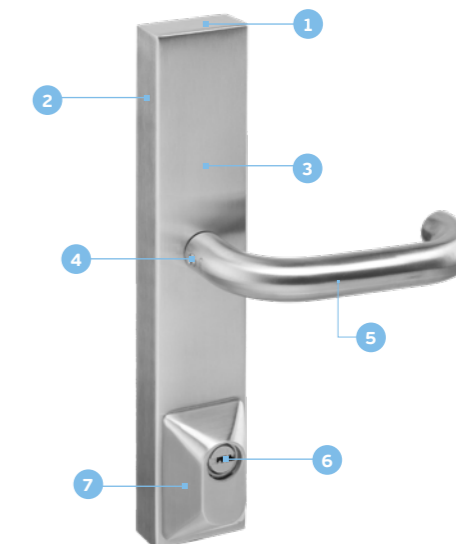

MOLAS PARA PORTAS DE VIDRO / FLOOR CLOSER FOR GLASS DOORS / CIERRE PARA PUERTAS DE CRISTAL.



1. Molas de pavimento para portas com peso até 200kg; Força ajustável por mola: Depois de instaladas, a força pode ser ajustada por um parafuso lateral.

2. Equipadas com duas válvulas de ajuste de velocidade de fecho:

1) Válvula de controlo de velocidade de fecho inicial dos 160° aos 15°.

2) Válvula de controlo de velocidade de fecho final, dos 15° aos 0° de ângulo, especialmente útil para evitar que a porta bata no aro ou se necessário ter velocidade para vencer o trinco da fechadura.

3. Mola de pavimento com sistema CAM. A relação de força não é direta, variando conforme o ângulo de abertura, permitindo forças de abertura baixas, mas forças elevadas no fecho, tornando este tipo de mola aconselhado para espaços onde é operado por pessoas com mobilidade condicionada e crianças.

4. Sistema de quadras intercambiáveis permitindo a aplicação com diferentes formatos e alturas (22x11,6mm / 17x17mm / 13x13mm)

5. Possibilidade de tampas em aço inoxidável com acabamentos satinado, polido e PVD TITANIUM com diferentes cores.

6. Sistema de ajuste 3D. Permite ajustar a posição da mola relativamente à caixa fixa ao pavimento.

7. Funcionamento estável entre os -20° e 40°.

8. Opção com e sem paragem, marcação CE e certificação corta-fogo na versão sem retenção.

1. Floor springs for doors weighing up to 200kg; Adjustable spring force: Once installed, the power can be adjusted by a lateral screw.

2. Equipped with two closing speed adjustment valves:
 1) Initial closing speed control valve from 160° to 15°.
 2) Final closing speed control valve, from 15° to 0° of angle, especially useful to prevent the door from hitting the door frame or if necessary to have the speed to beat the lock latch.

3. Floor spring with CAM system. The force ratio is not direct, varying according to the opening angle, allowing low opening forces, but high closing forces, making this type of spring advised for spaces where it is operated by people with limited mobility and children.

4. System of interchangeable spindles allowing the application with different formats and heights: (22x11,6mm / 17x17mm / 13x13mm)

5. Possibility of stainless steel covers with satin, polished and PVD TITANIUM finishes in different colours.

6. 3D adjustment system. It allows to adjust the position of the spring in relation to the box fixed to the floor.

7. Stable operation between -20° and 40°.

8. Option with and without stop, CE marking and fireproof certification in the version without stop.

1. Cierra puertas de suelo con un peso de hasta 200kg; Fuerza ajustable mediante muelle: Una vez instalada, la fuerza puede ajustarse mediante un tornillo lateral.

2. Equipado con dos válvulas de ajuste de la velocidad de cierre:

1) Válvula de control de velocidad de cierre inicial de 160° a 15°.

2) Válvula de control de velocidad de cierre final, de 15° a 0° de ángulo, especialmente útil para evitar que la puerta golpee el marco o si es necesario tener la velocidad para activar el pestillo de la cerradura.

3. Muelle de suelo con sistema CAM.

La relación de fuerzas no es directa, variando en función del ángulo de apertura, permitiendo fuerzas de apertura bajas, pero fuerzas de cierre elevadas, lo que hace que este tipo de muelle sea aconsejado para espacios donde sea accionado por personas con movilidad reducida y niños.

4. Sistema de cuerdillos intercambiables que permite la aplicación con diferentes formatos y alturas: (22x11,6mm / 17x17mm / 13x13mm)

5. Posibilidad de cubiertas de acero inoxidable con acabados satinado, pulido y PVD TITANIO en diferentes colores.

6. Sistema de ajuste 3D. Permite ajustar la posición del muelle en relación con la caja fijada al suelo.

7. Funcionamiento estable entre -20° y 40°.

8. Opción con y sin retención, marcado CE y certificación ignífuga en la versión sin retención.

COMBO 200KG FLOOR SPRINGS

MOLAS DE PAVIMENTO PARA PORTAS DE BATENTE OU VAI-VÉM APLICÁVEL EM PORTAS DE MADEIRA, METÁLICAS OU DE VIDRO / FLOOR CLOSER FOR SINGLE ACTION OR DOUBLE ACTION DOORS APPLICABLE TO WOODEN, METALLIC OR GLASS DOORS / CIERRA PUERTAS DE SUELO PARA PUERTAS DE BATIENTE O DOBLE ACCIÓN, APLICABLE A PUERTAS DE MADERA, METALICAS O DE CRISTAL.

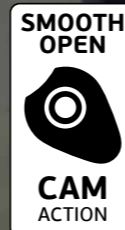
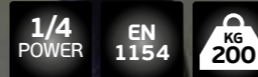

MOLAS PARA PORTAS DE VIDRO / FLOOR CLOSER FOR GLASS DOORS / CIERRE PARA PUERTAS DE CRISTAL.

21.2205

Mola de pavimento para portas de batente ou vai-vém aplicável em portas de madeira, metálicas ou de vidro, com paragem a 90° / Floor closer for single action doors or double action doors applicable to wooden, metallic or glass doors with a hold open position at 90° / Cierra puertas de suelo para puertas de batiente o doble acción, aplicable a puertas de madera, metálicas o de cristal con retención a 90°.

Power adjustment by spring



21.2205 Satin Stainless steel



21.2205.TB PVD TITANIUM Black



21.2205.TG PVD TITANIUM Gold



21.2205.TCO PVD TITANIUM Copper



21.2205.TCH PVD TITANIUM Chocolate

EN1154 3 8 1 4 - 1 3

21.001.Q

Quadra standard / Standard spindle / Cuadradillo estándar. 17x17mm



21.001.QS

Quadra / Spindle / Cuadradillo. 13x13mm



21.001.R

21.001.R10 21.001.R20 Quadra rectangular / Rectangular spindle / Cuadradillo rectangular 22x11,6mm

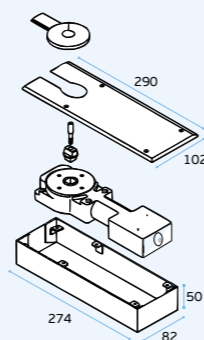
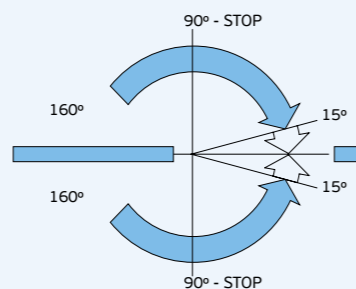
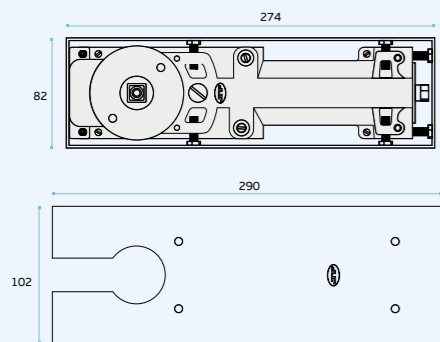

21.2205.B

Mola de pavimento para portas de batente ou vai-vém aplicável em portas de madeira, metálicas ou de vidro sem paragem / Floor closer for single action doors or double action doors applicable to wooden, metallic or glass doors without hold open position / Cierra puertas de suelo para puertas de batiente o doble acción, aplicable a puertas de madera, metálicas o de cristal sin retención.

Power adjustment by spring



21.2205.B Satin Stainless steel



21.2205.B.TB PVD TITANIUM Black



21.2205.B.TG PVD TITANIUM Gold



21.2205.B.TCO PVD TITANIUM Copper



21.2205.B.TCH PVD TITANIUM Chocolate

EN1154 3 8 1 4 - 1 3

21.001.Q

Quadra standard / Standard spindle / Cuadradillo estándar. 17x17mm



21.001.QS

Quadra / Spindle / Cuadradillo. 13x13mm



21.001.R

21.001.R10 21.001.R20 Quadra rectangular / Rectangular spindle / Cuadradillo rectangular 22x11,6mm

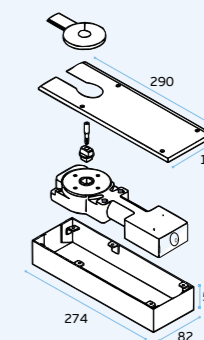
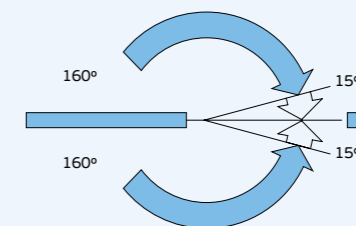
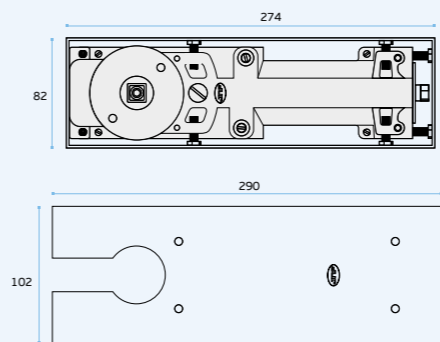

MOLAS PARA PORTAS DE VIDRO / FLOOR CLOSER FOR GLASS DOORS / CIERRE PARA PUERTAS DE CRISTAL.

OVERHEAD DOOR CLOSER FOR GLASS DOORS



EN1154 4 8 2 1 1 3 5

ML.21.765

Mola de porta aérea hidráulica de sobrepor.

- Força ajustável: 2-5;
- Força: 1-3 (se aplicado com braços anti-vandalismo);
- Compatível com todos os braços JNF;
- Largura máxima de porta: 1250mm;
- Peso máximo de porta: 120kg;
- Ajuste de força por mola;
- Mecanismo cremalheira e pinhão;
- Velocidade de fecho ajustável por válvula;
- Velocidade de fecho final ajustável por válvula;
- Ângulo de abertura 180°;
- Mola reversível;
- Certificado corta-fogo;
- Marcação CE;

Hydraulic overhead door closer.

- Adjustable power: 2-5;
- Power: 1-3 (if applied with anti-vandalism arms);
- Compatible with all JNF arms;
- Maximum door width: 1250mm;
- Maximum door weight: 120kg;
- Power adjustment by spring;
- Rack and pinion mechanism;
- Closing speed adjustable by valve;
- Latching speed adjustable by valve;
- Opening angle 180°;
- Reversible door closer;
- Certified fireproof;
- CE marking;

Cierra puertas hidráulico de sobreponer.

- Fuerza ajustable: 2-5;
- Fuerza: 1-3 (si se aplica con brazos anti-vandalismo);
- Compatible con todos los brazos JNF;
- Ancho máximo de puerta: 1250mm;
- Peso máximo de puerta: 120kg;
- Regulación de fuerza por muelle;
- Mecanismo de piñon y cremallera;
- Velocidad de cierre ajustable por válvula;
- Velocidad de golpe final ajustable por válvula;
- Ángulo de apertura 180°;
- Cierra puertas reversible;
- Certificado corta fuego;
- Marcación CE;

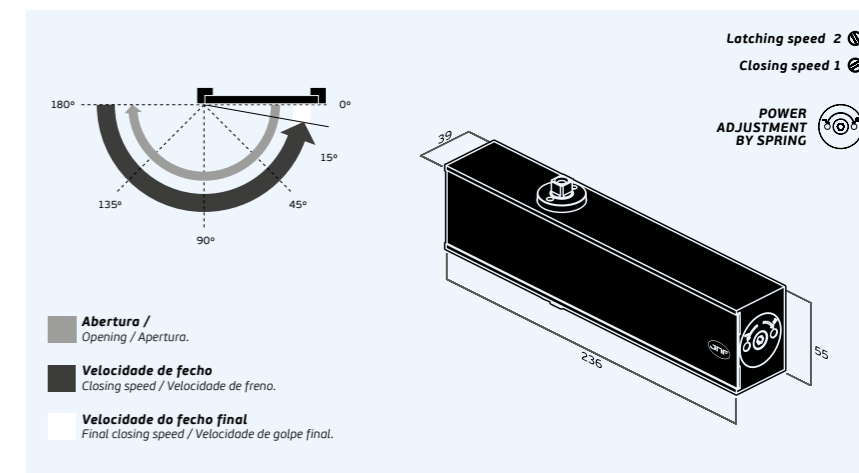

- 21.105.IN**
Braço standard em aço inoxidável /
Standard stainless steel arm /
Braço estándar en acero inoxidable.
- 21.105.AN**
Braço standard RAL 9006 /
RAL 9006 standard arm /
Braço estándar RAL 9006.
- 21.101.IN**
Braço anti-vandalismo cor inox /
Stainless steel color sliding arm /
Braço antivandalismo color inoxidable.
- IN.21.BD**
Braço design em aço inoxidável /
Stainless steel design sliding arm /
Braço diseño en acero inoxidable.
- 21.101.AN**
Braço anti-vandalismo RAL 9006 /
RAL 9006 sliding arm /
Braço antivandalismo RAL 9006.
- 21.110.AN**
Braço com retenção RAL 9006 /
Hold open arm RAL 9006 /
Braço con retencion RAL 9006.

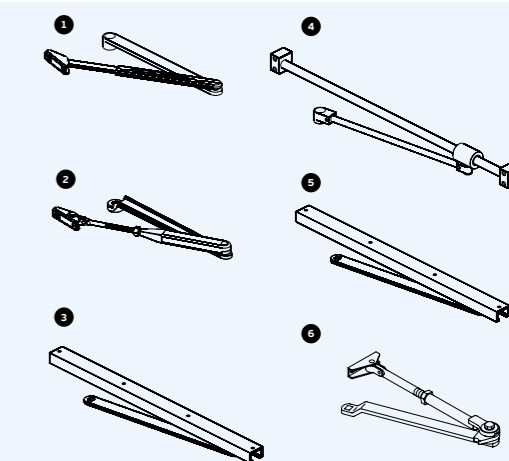

- 21.765.HD**
Tampa reforçada em aço inoxidável /
Reinforced stainless steel cover /
Cubierta reforzada en acero inoxidable /
- 21.201.Q**
Tampa em aço inoxidável quadrada /
Square stainless steel cover /
Cubierta en acero inoxidable cuadrada /

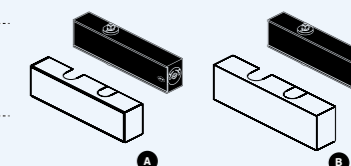

MOLAS PARA PORTAS DE VIDRO / FLOOR CLOSER FOR GLASS DOORS / CIERRE PARA PUERTAS DE CRISTAL.



Power
adjustment
by position



EN1154 4 8 2 1 1 3

ML.21.760

Mola de porta aérea hidráulica de sobrepor.

- Força ajustável: 2-4;
- Força: 1 (se aplicado com braços anti-vandalismo);
- Compatível com todos os braços JNF;
- Largura máxima de porta: 1100mm;
- Peso máximo de porta: 100kg;
- Ajuste de força por posição;
- Mecanismo cremalheira e pinhão;
- Velocidade de fecho ajustável por válvula;
- Velocidade de fecho final ajustável por válvula;
- Ângulo de abertura 180°;
- Mola reversível;
- Certificado corta-fogo;
- Marcação CE;

Hydraulic overhead door closer.

- Adjustable power: 2-4;
- Power: 1 (if applied with anti-vandalism arms);
- Compatible with all JNF arms;
- Maximum door width: 1100mm;
- Maximum door weight: 100kg;
- Power adjustment by position;
- Rack and pinion mechanism;
- Closing speed adjustable by valve;
- Latching speed adjustable by valve;
- Opening angle 180°;
- Reversible door closer;
- Certified fireproof;
- CE marking;

Cierra puertas hidráulico de sobreponer.

- Fuerza ajustable: 2-4;
- Fuerza: 1 (si se aplica con brazos anti-vandalismo);
- Compatible con todos los brazos JNF;
- Ancho máximo de puerta: 1100mm;
- Peso máximo de puerta: 100kg;
- Regulación de fuerza por posición;
- Mecanismo de piñon y cremallera;
- Velocidad de cierre ajustable por válvula;
- Velocidad de golpe final ajustable por válvula;
- Ángulo de apertura 180°;
- Cierra puertas reversible;
- Certificado corta fuego;
- Marcación CE;

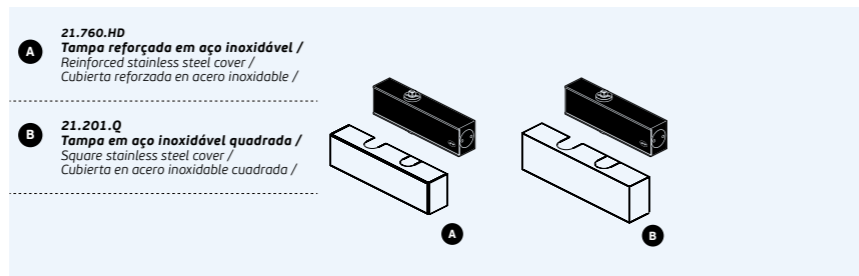
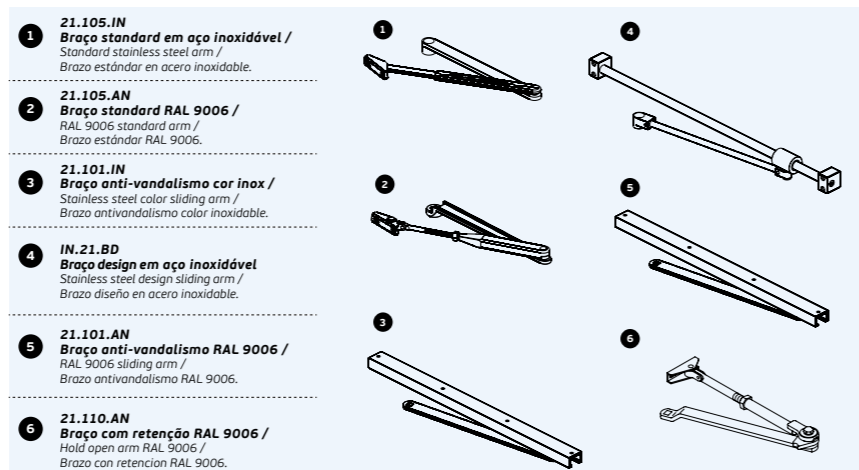
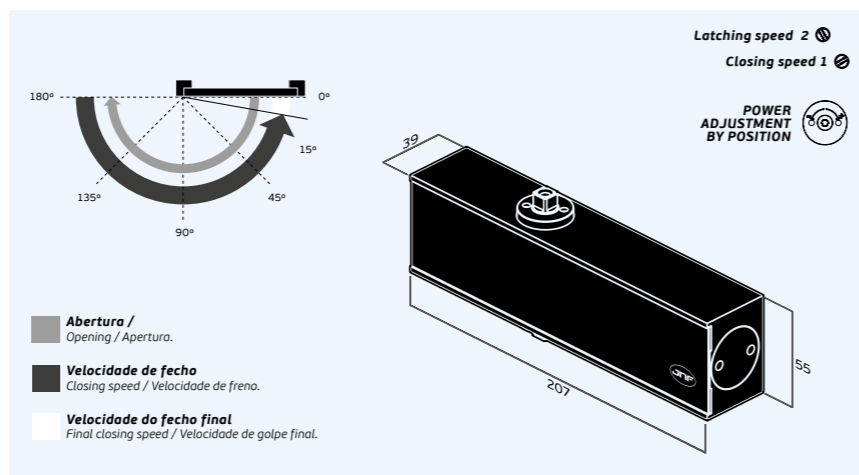

21.101.AN

Braço deslizante anti-vandalismo RAL 9006 /
Sliding anti-vandalism arm RAL 9006 /
Brazo deslizante antivandalismo RAL 9006.



21.105.AN

Braço standard RAL 9006 /
Standard arm RAL 9006 /
Brazo estándar RAL 9006.



21.BMV.760 21.BMV.765

Base para vidro, para instalação
de molas em portas de vidro / Glass
door base for installation of the door
closer to all glass doors / Base para
cristal para aplicação del cierra puertas
en puertas de cristal.

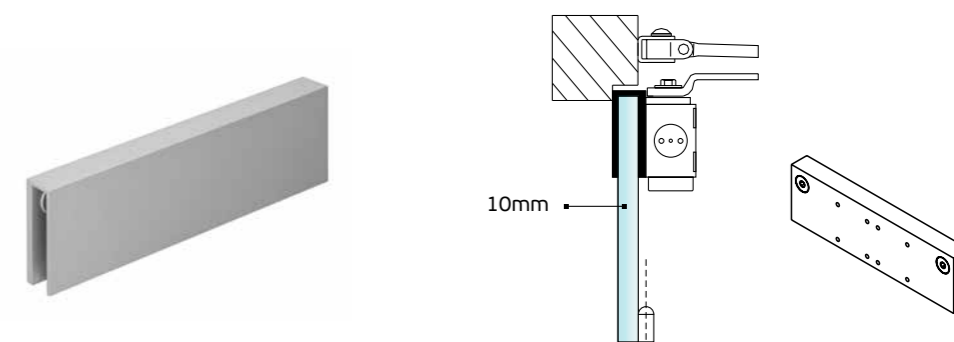

A

Acessórios para sistemas pivotantes para vidro
Pivots systems accessories for glass /
Accesorios para sistemas de pivote para cristal.

IN.81.108
Giro de pavimento ajustável /
Adjustable free floor pivot. /
Pivote de pavimento ajustable.

A) Rolamento que garante um funcionamento suave e silencioso.
Ball bearing. That ensures a smooth and quiet function./ Rodamiento que garantiza un movimiento suave y silencioso.

B) Quadra rectangular / Rectangular spindle. / Cuadradillo rectangular.

C) Ajustável em 2 eixos
Adjustable in 2 axes / Ajustable en 2 ejes.
+-5mm | +-6mm

D) Tampa em aço inoxidável.
Cover made in stainless steel /
Tapa en acero inoxidable

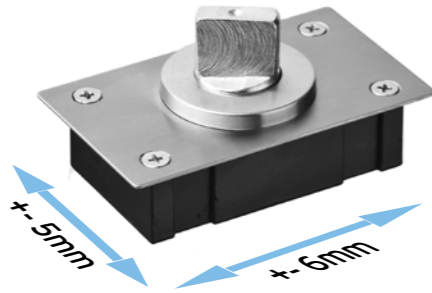

MATERIAL: EN 1.4301 / AISI 304

ACABAMENTO / FINISH / ACABADO:
STANDARD: SATINADO / SATIN / SATIN

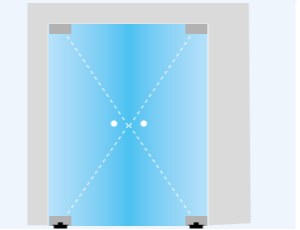
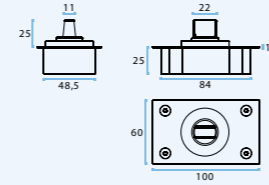

IN.81.218
Batente de porta para fixar no aro, tecto, pavimento ou parede /
Door stopper to use in door frame, ceiling, floor or wall /
Tope para usar en el marco de la puerta, techo, suelo o pared.

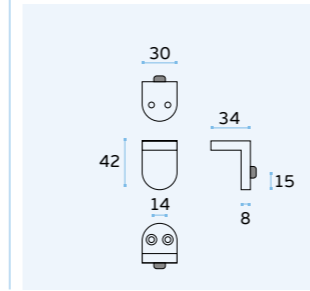

MATERIAL: EN 1.4301 / AISI 304

ACABAMENTO / FINISH / ACABADO:
STANDARD: SATINADO / SATIN / SATIN

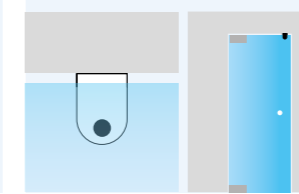

RR.13.005
Batente de porta para fixar no aro, tecto, pavimento ou parede /
Door stopper to use in door frame, ceiling, floor or wall /
Tope para usar en el marco de la puerta, techo, suelo o pared.

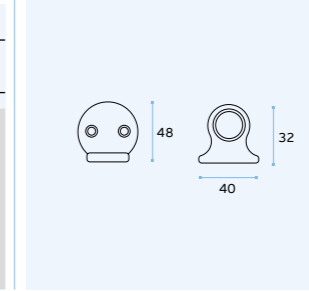

MATERIAL: EN 1.4301 / AISI 304

ACABAMENTO / FINISH / ACABADO:
STANDARD: SATINADO / SATIN / SATIN

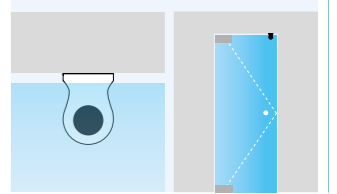

IN.81.105
Giro de pavimento /
Floor pivot. /
Pivote de pavimento.

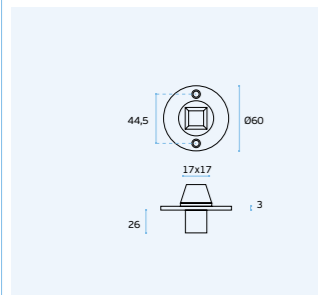

MATERIAL: EN 1.4301 / AISI 304

ACABAMENTO / FINISH / ACABADO:
STANDARD: SATINADO / SATIN / SATIN

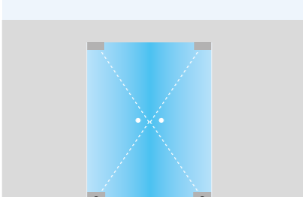

IN.81.217
Pivot para tecto /
Ceilling pivot / Pivote para techo

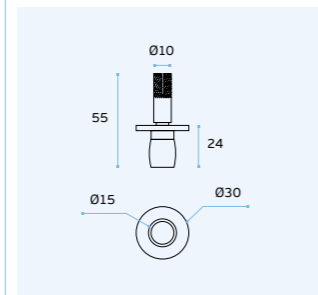

MATERIAL: EN 1.4301 / AISI 304

ACABAMENTO / FINISH / ACABADO:
STANDARD: SATINADO / SATIN / SATIN

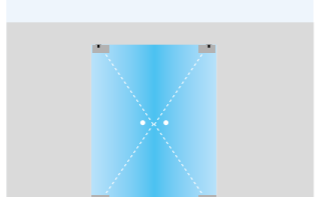

IN.81.219
Batente de porta para fixar no vidro superior /
Door stopper to use in upper glass. /
Tope para usar en el cristal superior.

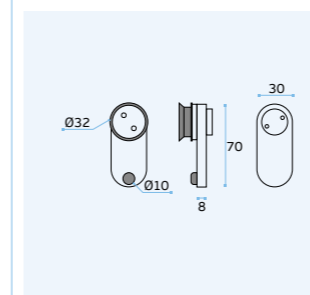

MATERIAL: EN 1.4301 / AISI 304

ACABAMENTO / FINISH / ACABADO:
STANDARD: SATINADO / SATIN / SATIN

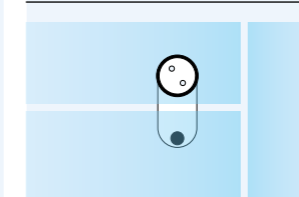

NEW

IN.13.003
Batente de chão /
Door stopper /
Tope de puerta.

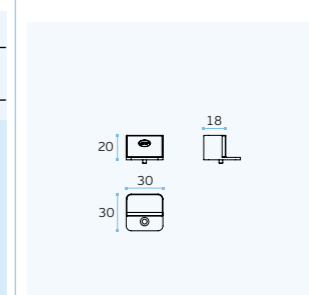

MATERIAL: EN 1.4301 / AISI 304

ACABAMENTO / FINISH / ACABADO:
STANDARD: SATINADO / SATIN

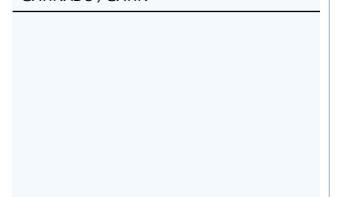

IN.05.197.S
Giro superior de embutir para aro de porta /
Top pivot for door frame (concealed) / Giro superior de embutir.

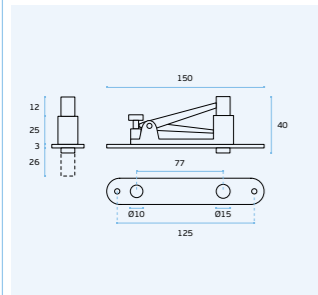

MATERIAL: EN 1.4301 / AISI 304

ACABAMENTO / FINISH / ACABADO:
STANDARD: SATINADO / SATIN / SATIN

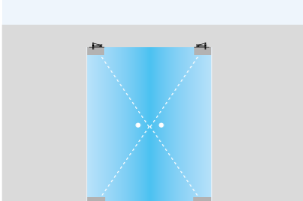

IN.81.106
Pivot para tecto /
Ceilling pivot / Pivote para techo

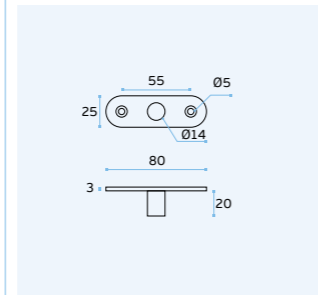

MATERIAL: EN 1.4301 / AISI 304

ACABAMENTO / FINISH / ACABADO:
STANDARD: SATINADO / SATIN / SATIN

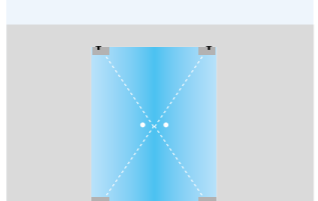

IN.13.187
Batente de porta com retenção magnética para porta em vidro /
Door stopper with magnetic holder for glass door /
Tope de puerta con retenedor magnetico para puerta en cristal.

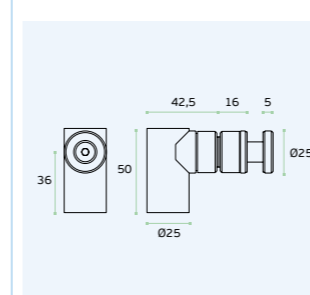

MATERIAL: EN 1.4301 / AISI 304

ACABAMENTO / FINISH / ACABADO:
STANDARD: SATINADO / SATIN



IN.13.008
Batente de chão /
Door stopper /
Tope de puerta.
Design: Miguel Vasconcelos

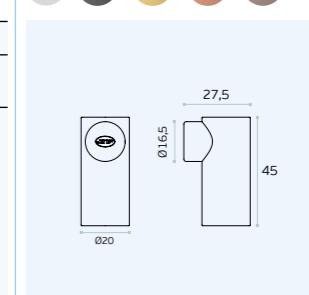

MATERIAL: EN 1.4301 / AISI 304

ACABAMENTO / FINISH / ACABADO:
STANDARD: SATINADO / SATIN

OPCIONAL / OPTIONAL:
POLIDO / POLISHED / PULIDO
OPCIONAL / OPTIONAL: PVD TITANIUM

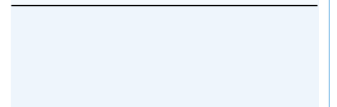

LINEAR MANUAL SYSTEM

SISTEMAS MANUAIS PARA PORTAS DE CORRER COM CARRIL DE ALUMÍNIO /
MANUAL SLIDING DOOR SYSTEMS WITH ALUMINIUM TRACK /
SISTEMAS MANUALES PARA PUERTAS CORREDERAS CON CARRIL DE ALUMINIO /

LINEAR SYSTEM

MANUAL SLIDING DOOR SYSTEMS

SISTEMAS MANUAIS PARA PORTAS DE
CORRER COM CARRIL DE ALUMÍNIO /
MANUAL SLIDING DOOR SYSTEMS WITH
ALUMINIUM TRACK /
SISTEMAS MANUALES PARA PUERTAS
CORREDERAS CON CARRIL DE ALUMINIO.



LINEAR MANUAL SYSTEM

SISTEMAS MANUAIS PARA PORTAS DE CORRER COM CARRIL DE ALUMÍNIO /
 MANUAL SLIDING DOOR SYSTEMS WITH ALUMINIUM TRACK /
 SISTEMAS MANUALES PARA PUERTAS CORREDERAS CON CARRIL DE ALUMINIO /

Sistema inovador para portas de correr, elegante e compacto, de rápida e fácil instalação. Movimento silencioso e suave.

Desenhado especificamente para portas interiores. Com menos elementos mecânicos, logo, de fácil manutenção. Seguro e durável.

Pode ser aplicado em portas duplas ou simples de vidro, madeira ou metal, até um peso máx. de 150kg/ porta.

O desenho do carril permite diversos tipos de fixação. Ajustes frontais. Várias cores disponíveis.

Cumprir norma EN1527:2013 100,000 ciclos de teste.

Innovative sliding door system, elegant and compact, quick and easy to install. With silent and smooth movement.

Designed specifically for interior doors. With less mechanical elements and, easy maintenance. Safe and durable.

Can be applied on double or single glass, wood or metal doors, up to max. 150kg/door.

The rail design allows for various types of fixing ways. Front adjustments. Various colors available.

Complies with EN1527: 2013 100,000 test cycles.

Sistema innovador para puertas correderas, elegante y compacto, de rápida y fácil instalación. Con movimiento silencioso y suave.

Diseñado específicamente para puertas interiores. Con menos elementos mecánicos, por lo tanto, de fácil mantenimiento. Seguro y durable.

Puede ser aplicado en puertas dobles o simples de cristal, madera o metal, hasta un peso máx. de 150kg/puerta.

El diseño de carril permite diversos tipos de fijación. Ajustaciones frontales. Varios colores disponibles.

Cumple la norma EN1527: 2013 100.000 ciclos de prueba.

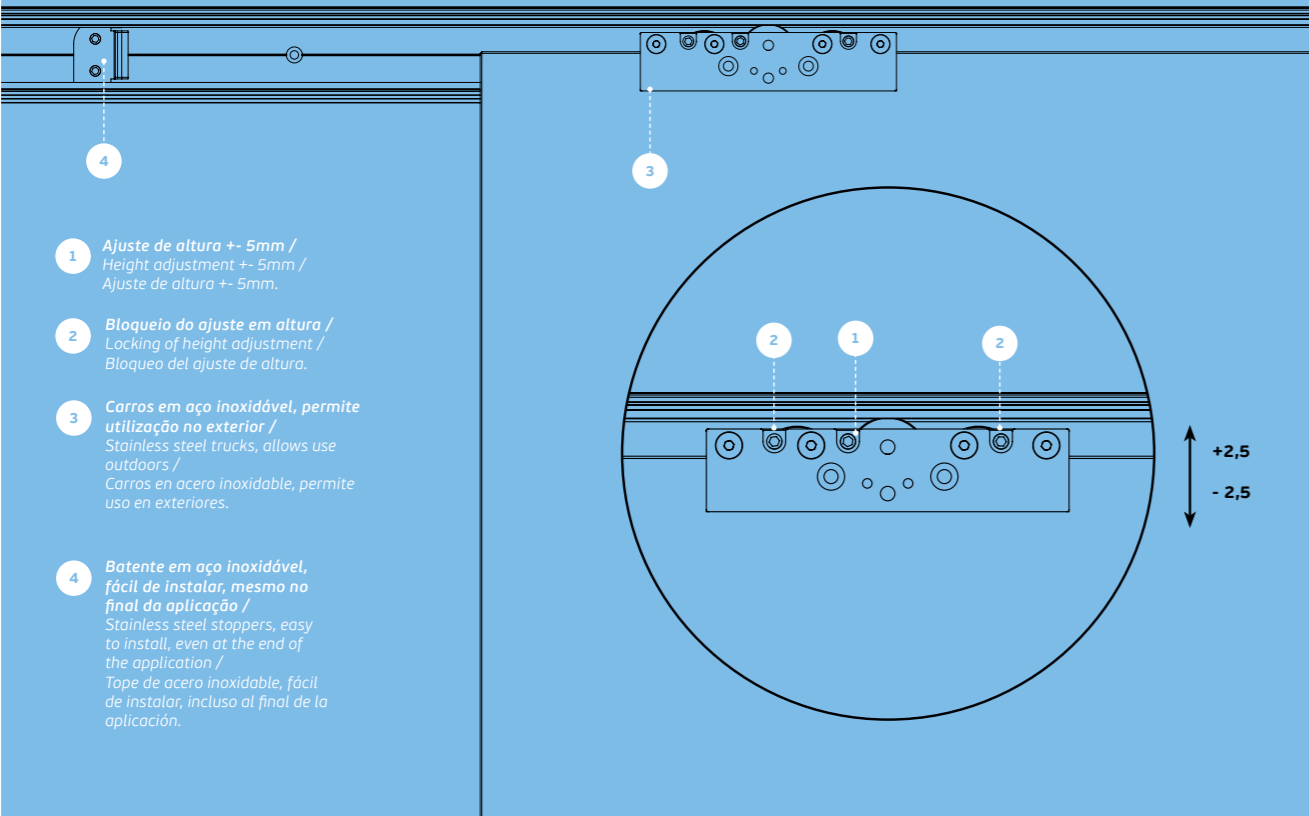

S LINEAR STANDARD

Sistema standard manual. Pode ser aplicado com portas duplas ou simples de vidro, madeira ou metal, até um peso máx. de 150kg por porta. A porta não necessita de entalhes.

Manual standard system. Can be applied with double or single doors made of glass, wood or metal up to max.150kg/door. The door does not require cutouts.

Sistema estándar manual. Puede ser aplicado con puertas dobles o simples de cristal, madera o metal, hasta un peso máx.150kg/puerta. La puerta no necesita taladros.



LINEAR SOFT

Sistema manual com fecho suave. Pode ser aplicado em portas simples ou duplas de vidro, madeira ou metal, até um peso máx. de 80kg por porta. Não são necessários entalhes. Fecho silencioso com amortecedor, que reduz a velocidade da porta no fecho final.

Manual system with soft closing. It can be applied to single or double glass, wood or metal doors, up to a max. weight. 80kg/door. No cutouts are required. Silent closure with damper, which reduces the speed of the door in the final closure.

Sistema manual con cierre suave. Puede ser aplicado en puertas simples o dobles de cristal, madera o metal, hasta un peso máx. de 80kg/puerta. No se necesitan taladros. Cierre silencioso con amortiguador, que reduce la velocidad de la puerta en el cierre final.



LINEAR SINCR

Sistema manual para portas sincronizadas. Indicado para vãos de grandes dimensões. Pode ser aplicado em portas duplas de vidro, madeira ou metal, até um peso máx. de 150kg por porta. Não são necessários entalhes.

Manual system for synchronized doors. Suitable for large spans. Can be applied to double glass, wood or metal doors, up to max. of 150kg/door. No cutouts are required.

Sistema manual para puertas sincronizadas. Indicado para grandes vanos. Puede ser aplicado en puertas dobles de cristal, madera o metal, hasta un peso máx. de 150kg/puerta. No se necesitan taladros.



LINEAR FIT

Sistema manual com suportes em aço inoxidável que permitem um afastamento do vidro à parede de apenas 12mm. Pode ser aplicado em portas simples de vidro até um peso máx. de 150kg por porta. Neste modelo, a porta necessita de entalhes.

Manual system with stainless steel brackets that allows a distance of glass to the wall of only 12mm. Can be applied on single glass doors up to max. of 150kg/door. In this model, the door needs cutouts.

Sistema manual con soportes de acero inoxidable que permiten un alejamiento del cristal a la pared de apenas 12mm. Puede ser aplicado en puertas simples de cristal hasta un peso máx. de 150kg/puerta. En este modelo, la puerta necesita de taladros.

LINEAR STANDARD SINGLE DOOR

SISTEMAS MANUAIS PARA PORTAS DE CORRER COM CARRIL DE ALUMÍNIO / MANUAL SLIDING DOOR SYSTEMS WITH ALUMINIUM TRACK / SISTEMAS MANUALES PARA PUERTAS CORREDERAS CON CARRIL DE ALUMINIO /

LINEAR STANDARD SINGLE DOOR

A SIMPLICIDADE DE UM SISTEMA DE PORTA DE CORRER COM CARGA MÁXIMA DE 150KG, COM A VANTAGEM DO VIDRO NÃO TER ENTALHES.

THE SIMPLICITY OF A SLIDING DOOR SYSTEM WITH A MAXIMUM LOAD OF 150KG, WITH THE ADVANTAGE OF THE GLASS WITHOUT CUTOUTS.

LA SIMPLICIDAD DE UN SISTEMA DE PUERTAS CORREDERAS CON UNA CARGA MÁXIMA DE 150 KG, CON LA VENTAJA DEL CRISTAL SIN TALADROS.



LINEAR STANDARD **S** 150 Kg 8-12 mm FOR SINGLE GLASS DOOR

- 1. Carril superior em alumínio anodizado cor inox / Upper track in aluminium anodized color inox / Carril superior en aluminio anodizado color inox. (2000/3000/4000mm)**
- 2. Tampa frontal em alumínio anodizado cor inox / Front cover in aluminium anodized color inox / Tapa frontal en aluminio anodizado color inox. (2000/3000/4000mm)**
- 3. Tampa lateral em aço inoxidável / Side cover in stainless steel / Tapa lateral en acero inoxidable.**
- 4. Ajuste de altura +- 5mm / Height adjustment +- 5mm / Ajuste de altura +- 5mm.**
- 5. Bloqueio do ajuste em altura / Height adjustment lock / Bloqueo del ajuste de altura**
- 6. Carras em aço inoxidável, permite utilização no exterior / Stainless steel trucks, allows outdoor use / Carras en acero inoxidable, permite uso en exteriores.**
- 7. Batente em aço inoxidável, fácil de instalar, mesmo no final da aplicação / Stainless steel stopper, easy to install, even at the end of the application / Tapa de acero inoxidable, fácil de instalar, incluso al final de la aplicación.**
- 8. Vidro laminado ou temperado de 8 a 12mm de espessura com peso máximo de 150kg sem necessidade de entalhes / Laminated or tempered glass from 8 to 12mm thick with a maximum weight of 150kg without the need for cutouts / Cristal laminado o templado de 8 a 12mm de espesor con un peso máximo de 150kg sin necesidad de taladros.**
- 9. Guia de pavimento para vidro com espessura ajustável em aço inoxidável / Floor guide for glass with adjustable thickness in stainless steel / Guía de piso para cristal con espesor ajustable en acero inoxidable.**

ACABAMENTOS DISPONÍVEIS / AVAILABLE FINISHINGS / ACABADOS DISPONIBLES.

- STANDARD INOX** Alu. + Satin Anodized
- .B RAL BLACK** Aluminium + RAL 9005
- .GL GOLD LEAF** Aluminium + Gold Leaf
- .SILVER RAL SILVER** Aluminium + RAL 9006
- .W RAL WHITE** Aluminium + RAL 9016

Sistema standard manual. Pode ser aplicado com portas duplas ou simples de vidro, madeira ou metal, até um peso máx. de 150kg por porta. A porta não necessita de entalhes.

Manual standard system. Can be applied with double or single doors made of glass, wood or metal up to max.150kg/door. The door does not require cutouts

Sistema estándar manual. Puede ser aplicado con puertas dobles o simples de cristal, madera o metal, hasta un peso máx.150kg/puerta. La puerta no necesita taladros.

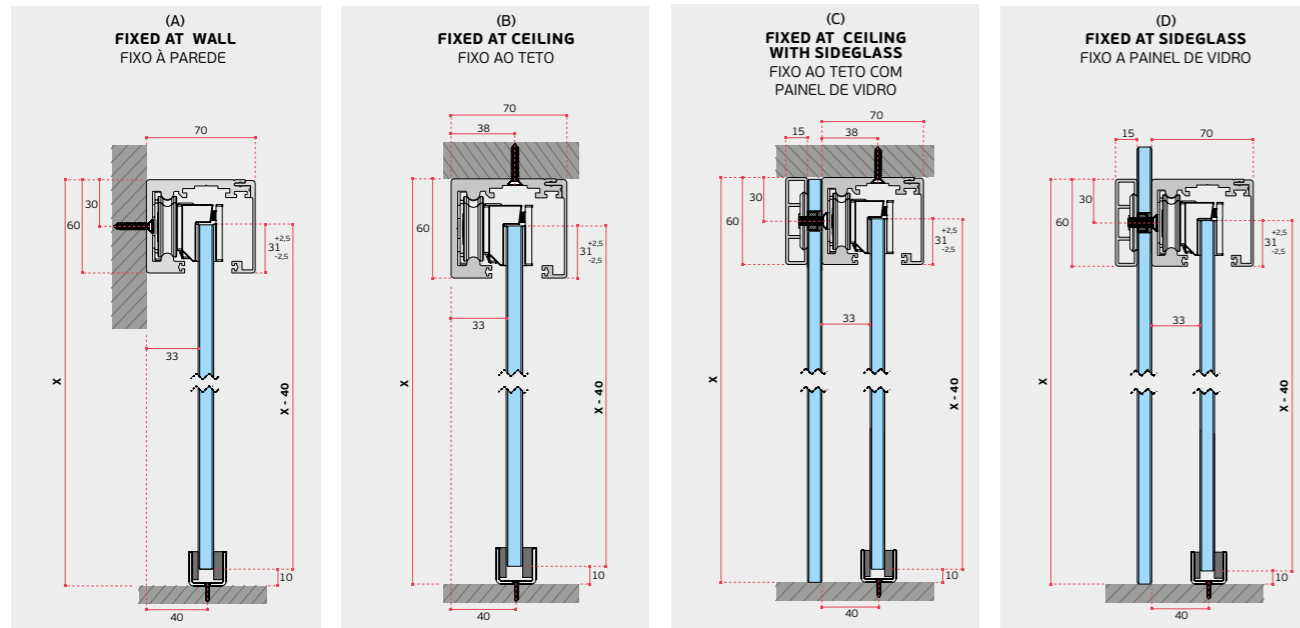

(A) FIXO À PAREDE / FIXED AT WALL / FIJADO A LA PARED.

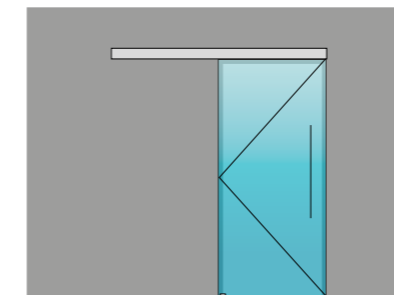

IN.15.700.2000
IN.15.700.3000
IN.15.700.4000
Sistema de porta de correr / Sliding door system / Sistema de puerta corredera. (2000/3000/4000mm)

(B) FIXO NO TETO / FIXED ON THE CEILING / FIJADO EN EL TECHO.

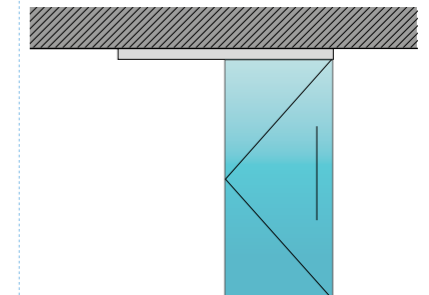

IN.15.700.2000
IN.15.700.3000
IN.15.700.4000
Sistema de porta de correr / Sliding door system / Sistema de puerta corredera. (2000/3000/4000mm)

(C) FIXO AO TETO COM PAINEL DE VIDRO / FIXED TO THE CEILING WITH GLASS PANEL / FIJACIÓN AL TECHO CON PANEL DE CRISTAL.

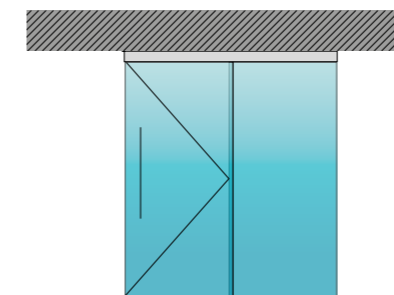

IN.15.700.2000
IN.15.700.3000
IN.15.700.4000
Sistema de porta de correr / Sliding door system / Sistema de puerta corredera. (2000/3000/4000mm)

IN.15.707.2000
IN.15.707.3000
IN.15.707.4000
Carril para suspensão no vidro fixo / Track for suspension on fixed glass / Carril para sujetar al cristal fijo.

(D) FIXO NO VIDRO / FIXED ON THE GLASS / FIJADO EN EL CRISTAL

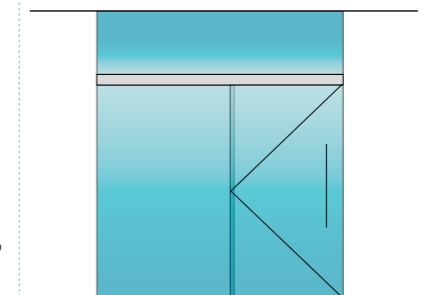

IN.15.700.2000
IN.15.700.3000
IN.15.700.4000
Sistema de porta de correr / Sliding door system / Sistema de puerta corredera. (2000/3000/4000mm)

IN.15.707.2000
IN.15.707.3000
IN.15.707.4000
Carril para suspensão no vidro fixo / Track for suspension on fixed glass / Carril para sujetar al cristal fijo.

LINEAR STANDARD DOUBLE DOORS

SISTEMAS MANUAIS PARA PORTAS DE CORRER COM CARRIL DE ALUMÍNIO / MANUAL SLIDING DOOR SYSTEMS WITH ALUMINIUM TRACK / SISTEMAS MANUALES PARA PUERTAS CORREDERAS CON CARRIL DE ALUMINIO /

LINEAR STANDARD DOUBLE DOORS

A SIMPLICIDADE DE UM SISTEMA DE PORTA DUPLA DE CORRER COM CARGA MÁXIMA DE 300KG, COM A VANTAGEM DO VIDRO NÃO TER ENTALHES.

THE SIMPLICITY OF A DOUBLE SLIDING DOOR SYSTEM WITH A MAXIMUM LOAD OF 300KG, WITH THE ADVANTAGE OF THE GLASS WITHOUT CUTOUTS.

LA SIMPLICIDAD DE UN SISTEMA DOBLE DE PUERTAS CORREDERAS CON UNA CARGA MÁXIMA DE 300KG, CON LA VENTAJA DEL CRISTAL SIN TALADROS.

LINEAR STANDARD **S** 150 Kg 8-12 mm FOR DOUBLE GLASS DOORS

ACABAMENTOS DISPONÍVEIS / AVAILABLE FINISHINGS / ACABADOS DISPONIBLES.

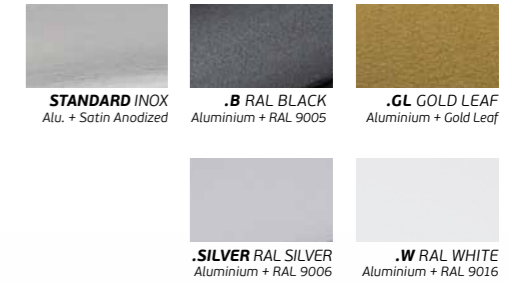

- 1. Carril superior em alumínio anodizado cor inox / Upper track in aluminium anodized color inox / Carril superior en aluminio anodizado color inox. (4000 / 6000mm)**
- 2. Tampa frontal em alumínio anodizado cor inox / Front cover in aluminium anodized color inox / Tampa frontal en aluminio anodizado color inox. (4000 / 6000mm)**
- 3. Tampa lateral em aço inoxidável / Side cover in stainless steel / Tampa lateral en acero inoxidable.**
- 4. Ajuste de altura +- 5mm / Height adjustment +- 5mm / Ajuste de altura +- 5mm.**
- 5. Bloqueio do ajuste em altura / Height adjustment lock / Bloqueo del ajuste de altura.**
- 6. Carros em aço inoxidável, permite utilização no exterior / Stainless steel trucks, allows outdoor use / Carros en acero inoxidable, permite uso en exteriores**
- 7. Batente em aço inoxidável, fácil de instalar, mesmo no final da aplicação / Stainless steel stopper, easy to install, even at the end of the application / Tape de acero inoxidable, fácil de instalar, incluso al final de la aplicación.**
- 8. Vidro laminado ou temperado de 8 a 12mm de espessura com peso máximo de 150kg sem necessidade de entalhes / Laminated or tempered glass from 8 to 12mm thick with a maximum weight of 150kg without the need for cutouts / Cristal laminado o templado de 8 a 12mm de espesor con un peso máximo de 150kg sin necesidad de taladros.**
- 9. Guia de pavimento para vidro com espessura ajustável em aço inoxidável / Floor guide for glass with adjustable thickness in stainless steel / Guía de piso para cristal con espesor ajustable en acero inoxidable.**

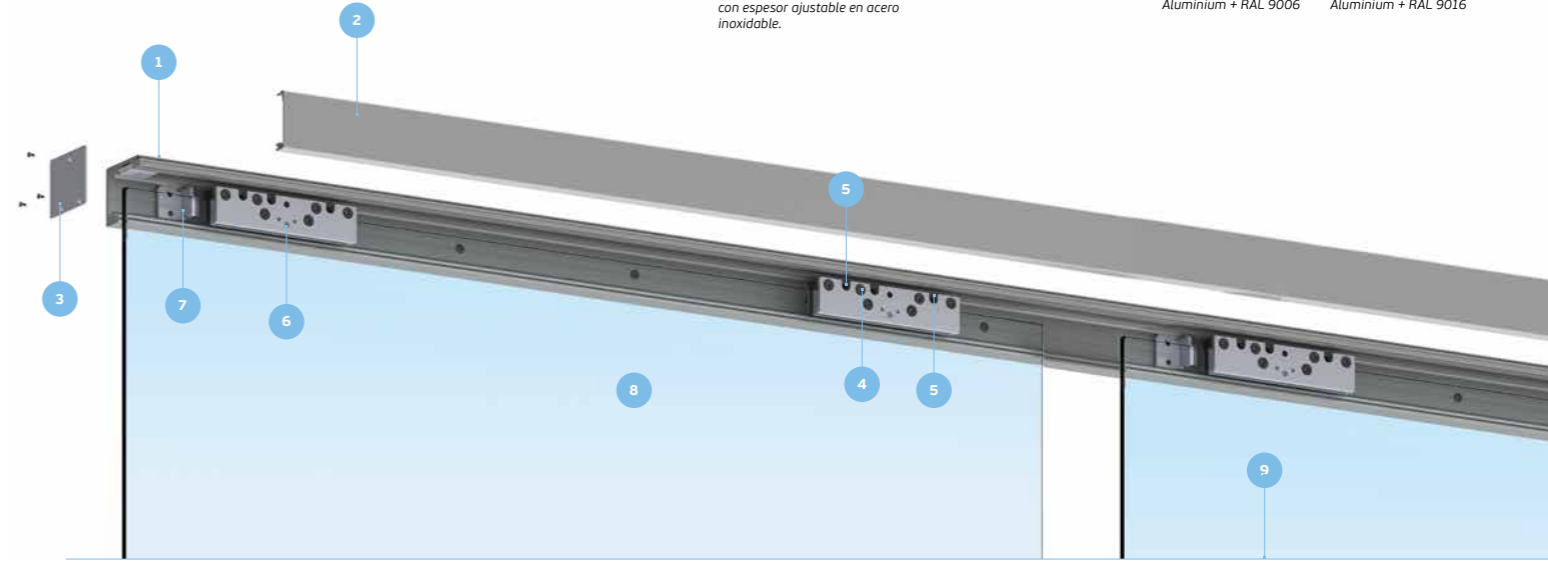

EN1527 - 6 | 3 - 1 | 2 - 1 | 3

Sistema standard manual. Pode ser aplicado com portas duplas ou simples de vidro, madeira ou metal, até um peso máximo de 150kg por porta. A porta não necessita de entalhes.

Manual standard system. It can be applied to double or single doors made of glass, timber or metal, up to a maximum weight of 150kg per door. The door does not need cutouts.

Sistema estándar manual. Se puede aplicar a puertas dobles o simples de vidrio, madera o metal, hasta un peso máximo de 150 kg por puerta. La puerta no necesita de taladros.

S LINEAR STANDARD

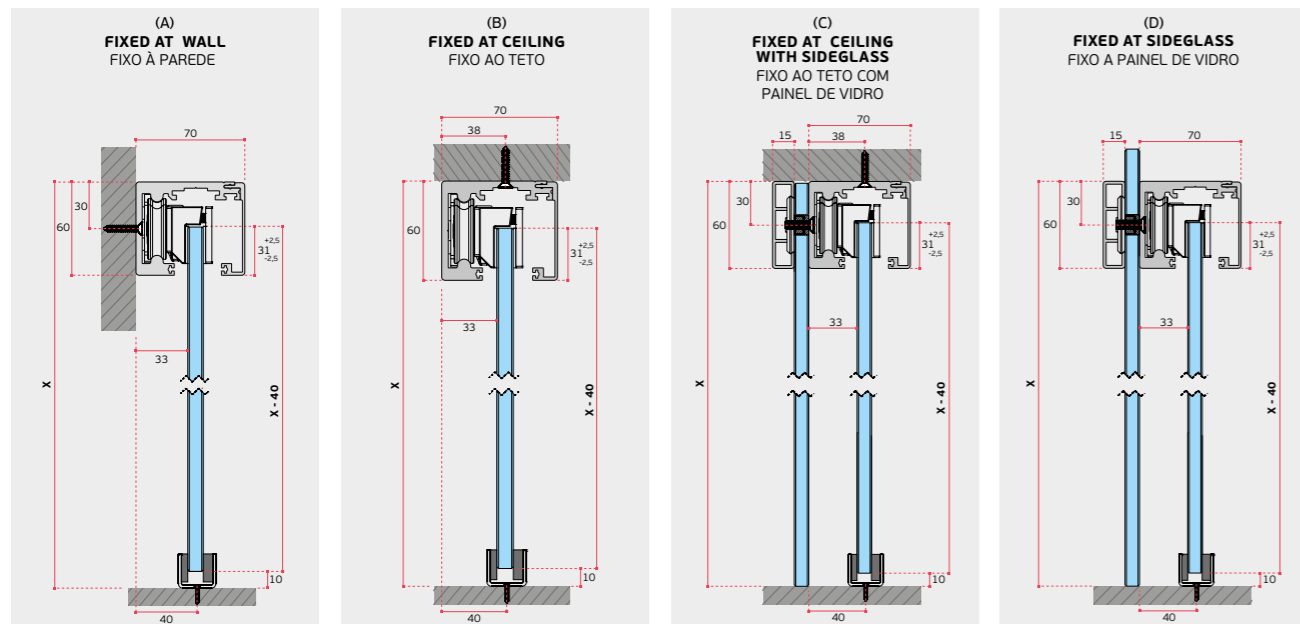

(A) **FIXO À PAREDE / FIXED AT WALL / FIJADO A LA PARED.**

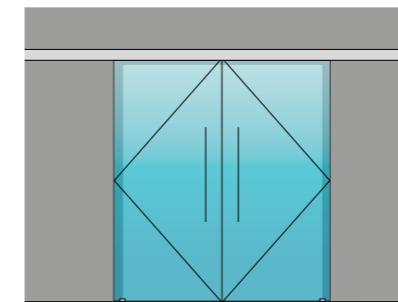

IN.15.703.4000
IN.15.703.6000
Sistema de porta de correr / Sliding door system / Sistema de puerta corredera. (4000/6000mm)

(B) **FIXO NO TETO / FIXED ON THE CEILING / FIJADO EN EL TECHO.**

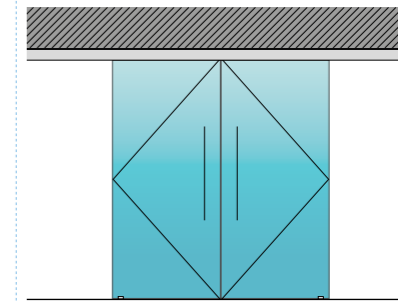

IN.15.703.4000
IN.15.703.6000
Sistema de porta de correr / Sliding door system / Sistema de puerta corredera. (4000/6000mm)

(C) **FIXO AO TETO COM PAINEL DE VIDRO / FIXED TO THE CEILING WITH GLASS PANEL / FIJACIÓN AL TECHO CON PANEL DE CRISTAL.**

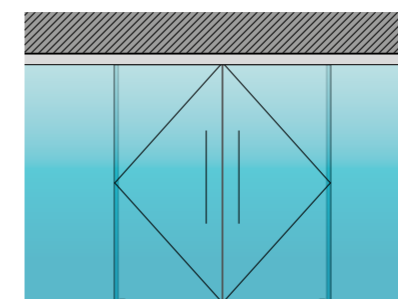

IN.15.703.4000
IN.15.703.6000
Sistema de porta de correr / Sliding door system / Sistema de puerta corredera. (4000/6000mm)

IN.15.707.4000
IN.15.707.6000
Carril para suspensão no vidro fixo / Track for suspension on fixed glass / Carril para sujetar al cristal fijo.

(D) **FIXO NO VIDRO / FIXED ON THE GLASS / FIJADO EN EL CRISTAL**

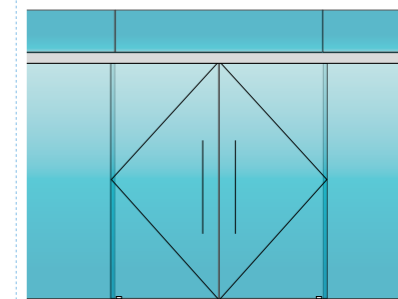

IN.15.703.4000
IN.15.703.6000
Sistema de porta de correr / Sliding door system / Sistema de puerta corredera. (4000/6000mm)

IN.15.707.4000
IN.15.707.6000
Carril para suspensão no vidro fixo / Track for suspension on fixed glass / Carril para sujetar al cristal fijo.

LINEAR SOFT SINGLE DOOR

SISTEMAS MANUAIS PARA PORTAS DE CORRER COM CARRIL DE ALUMÍNIO / MANUAL SLIDING DOOR SYSTEMS WITH ALUMINIUM TRACK / SISTEMAS MANUALES PARA PUERTAS CORREDERAS CON CARRIL DE ALUMINIO /

LINEAR SOFT SINGLE DOOR

A SUAVIDADE E AUSÊNCIA DE RUÍDO DO SISTEMA DE AMORTECIMENTO, INSTALADO NUM SISTEMA DE PORTAS DE CORRER, O LINEAR SOFT PERMITE PORTAS ATÉ 80KG. O SISTEMA DE FECHO SUAVE COM AMORTECEDOR A AR TORNA O FECHO PRECISO E CONSISTENTE.

THE SMOOTHNESS AND NO NOISE OF THE DAMPING SYSTEM, IN A SLIDING DOOR SYSTEM THE LINEAR SOFT ALLOWS DOORS TILL 80KG. THE SOFT CLOSE SYSTEM WITH AIR DUMPER MAKES RELIABLE AND CONSISTENT CLOSING.

LA SUAVIDAD Y AUSENCIA DE RUIDO DEL SISTEMA DE AMORTIGUACIÓN, INSTALADO EN UN SISTEMA DE PUERTA CORREDERA, EL LINEAR SOFT PERMITE PUERTAS HASTA 80KG. EL SISTEMA DE CIERRE SUAVE AMORTIGUADO POR AIRE HACE QUE EL CIERRE SEA PRECISO Y UNIFORME.

Sistema manual com fecho suave. Pode ser aplicado em portas simples ou duplas de vidro, madeira ou metal, até um peso máxmo de 80kg por porta. Não são necessários entalhes. Fecho silencioso com amortecedor, que reduz a velocidade da porta no fecho final.

Manual system with soft closing. It can be applied to single or double glass, timber or metal doors, up to a maximum weight of 80kg per door. No cutouts are required. Silent closure with damper, which reduces the speed of the door in the final closure.

Sistema manual con cierre suave. Puede ser aplicado en puertas simples o dobles de cristal, madera o metal, hasta un peso máxmo de 80kg por puerta. No necesita taladros. Cierre silencioso con amortiguador, que reduce la velocidad de la puerta en el cierre final.

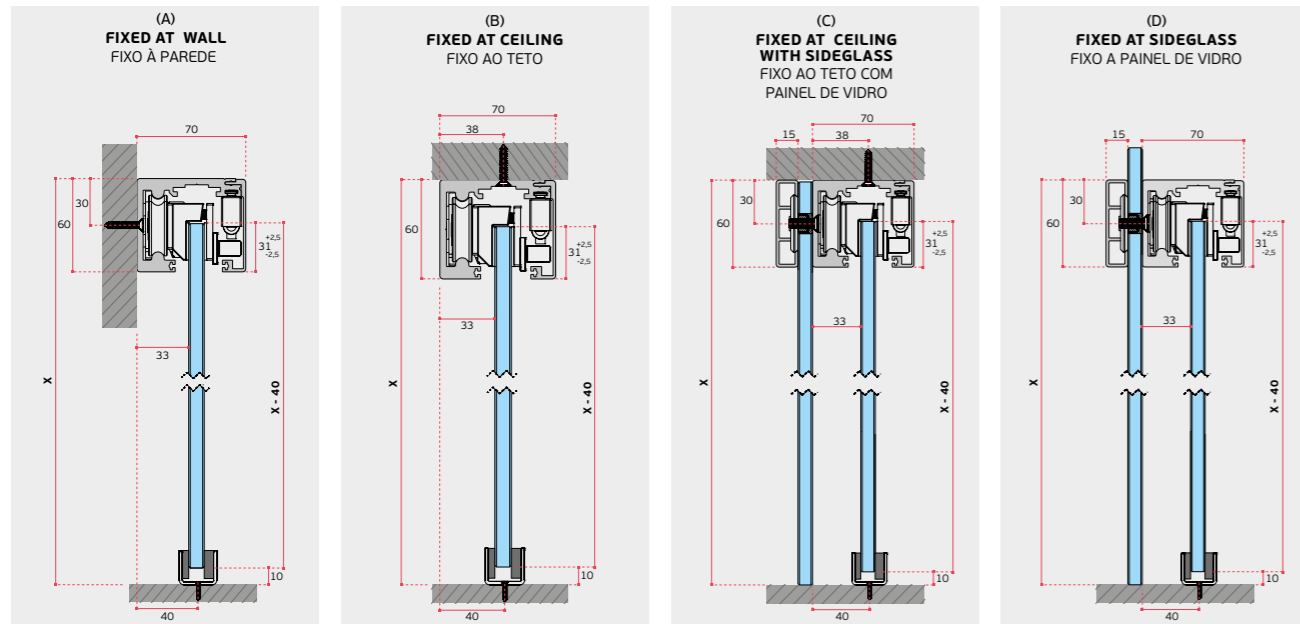

LINEAR SOFT FOR SINGLE GLASS DOOR

ACABAMENTOS DISPONÍVEIS / AVAILABLE FINISHINGS / ACABADOS DISPONIBLES.

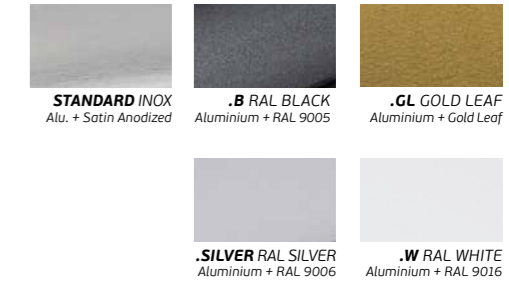

- 1. Carril superior em alumínio anodizado cor inox / Upper track in aluminium anodized color inox / Carril superior en aluminio anodizado color inox. (2000/3000/4000mm)**
- 2. Tampa frontal em alumínio anodizado cor inox / Front cover in aluminium anodized color inox. (2000/3000/4000mm)**
- 3. Tampa lateral em aço inoxidável / Side cover in stainless steel / Tapa lateral en acero inoxidable**
- 4. Ajuste de altura +- 5mm / Height adjustment +- 5mm / Ajuste de altura +- 5mm.**
- 5. Bloqueio do ajuste em altura / Height adjustment lock / Bloqueo del ajuste de altura.**
- 6. Carris em aço inoxidável, permite utilização no exterior / Stainless steel trucks, allows outdoor use / Carris en acero inoxidable, permite uso en exteriores.**
- 7. Batente em aço inoxidável, fácil de instalar, mesmo no final da aplicação / Stainless steel stopper, easy to install, even at the end of the application / Tapa de acero inoxidable, fácil de instalar, incluso al final de la aplicación.**
- 8. Vidro laminado ou temperado de 8 a 12mm de espessura com peso máximo de 80kg sem necessidade de entalhes / Laminated or tempered glass from 8 to 12mm thick with a maximum weight of 80kg without the need for cutouts / Cristal laminado o templado de 8 a 12mm de espesor con un peso máximo de 80kg sin necesidad de taladros.**
- 9. Guia de pavimento para vidro com espessura ajustável em aço inoxidável / Floor guide for glass with adjustable thickness in stainless steel / Guía de piso para cristal con espesor ajustable en acero inoxidable.**
- 10. Sistema de fecho suave com amortecedor de ar para portas até 80kg. Curso de 100mm e caixa metálica / Soft close system with air damper for 80kg doors. Stroke of 100mm and metallic case / Sistema de cierre suave con amortiguador de aire para puertas hasta 80kg. Carrera de 100 mm y caja metálica.**



EN1527

(A) FIXO À PAREDE / FIXED AT WALL / FIJADO A LA PARED.

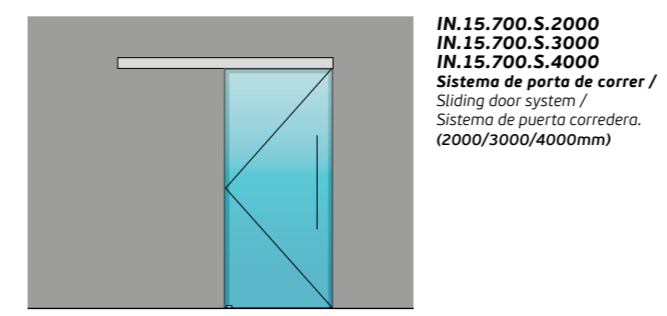

(B) FIXO NO TETO / FIXED ON THE CEILING / FIJADO EN EL TECHO.

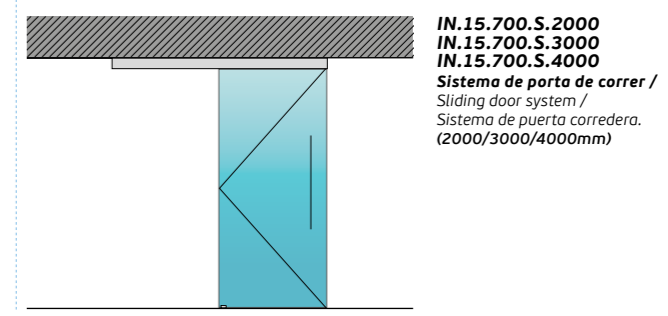

(C) FIXO AO TETO COM PAINEL DE VIDRO / FIXED TO THE CEILING WITH GLASS PANEL / FIJACIÓN AL TECHO CON PANEL DE CRISTAL.

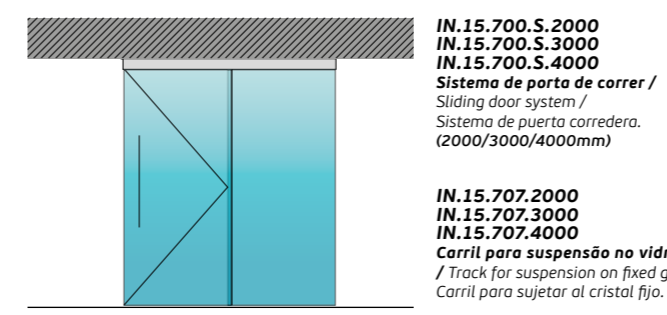

(D) FIXO NO VIDRO / FIXED ON THE GLASS / FIJADO EN EL CRISTAL

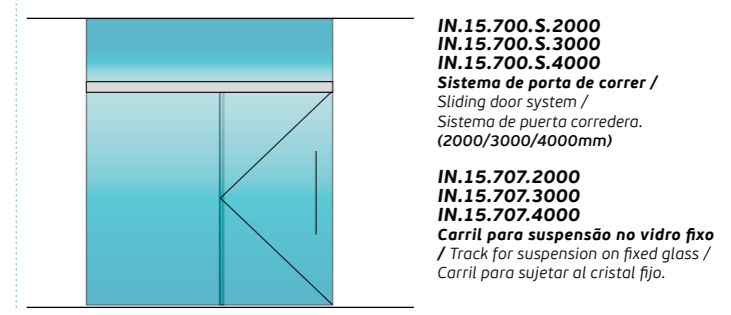

LINEAR SOFT DOUBLE DOORS

SISTEMAS MANUAIS PARA PORTAS DE CORRER COM CARRIL DE ALUMÍNIO /
MANUAL SLIDING DOOR SYSTEMS WITH ALUMINIUM TRACK /
SISTEMAS MANUALES PARA PUERTAS CORREDERAS CON CARRIL DE ALUMINIO /

LINEAR SOFT DOUBLE DOORS

O SISTEMA DE PORTA DUPLA PERMITE
CRIAR COMPARTIMENTAÇÕES EM VÃOS
DE GRANDES DIMENSÕES, ASSOCIADO
AO SISTEMA DE FECHO SUAVE COM
AMORTECEDOR A AR QUE TORNA O FECHO
PRECISO E CONSISTENTE.

THE DOUBLE DOOR SYSTEM MAKES IT POSSIBLE
TO CREATE COMPARTMENTS IN LARGE SPANS,
ASSOCIATED WITH THE SOFT CLOSING SYSTEM
WITH AIR DAMPER THAT MAKES THE CLOSING
PRECISE AND CONSISTENT.

LO SISTEMA DE DOBLE PUERTA PERMITE CREAR
COMPARTIMENTACION EN GRANDES VANOS,
ASOCIADO AL SISTEMA DE CIERRE SUAVE CON
AMORTIGUADOR DE AIRE QUE HACE QUE EL
CIERRE SEA PRECISO Y CONSISTENTE.

Sistema manual com fecho suave. Pode ser aplicado em portas simples ou duplas de vidro, madeira ou metal, até um peso máximo de 80kg por porta. Não são necessários entalhes. Fecho silencioso com amortecedor, que reduz a velocidade da porta no fecho final.

Manual system with soft closing. It can be applied to single or double glass, timber or metal doors, up to a maximum weight of 80kg per door. No cutouts are required. Silent closure with damper, which reduces the speed of the door in the final closure.

Sistema manual con cierre suave. Puede ser aplicado en puertas simples o dobles de cristal, madera o metal, hasta un peso máximo de 80kg por puerta. No se necesitan taladros. Cierre silencioso con amortiguador, que reduce la velocidad de la puerta en el cierre final.



LINEAR
SOFT

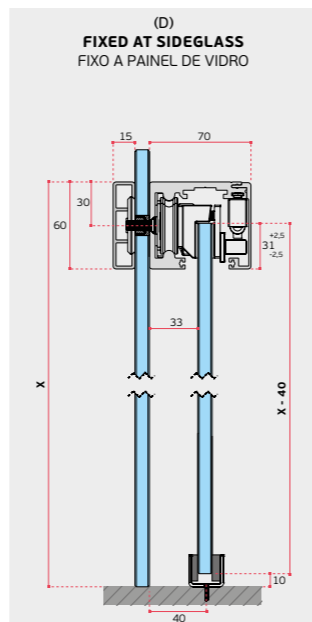
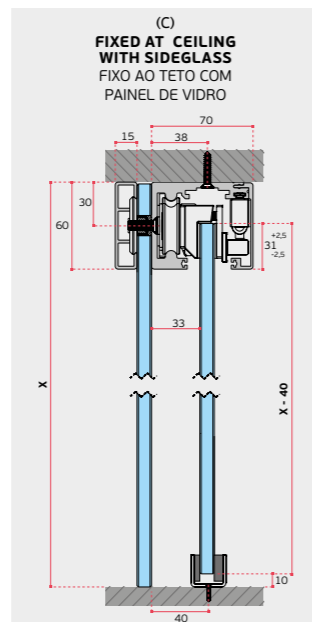
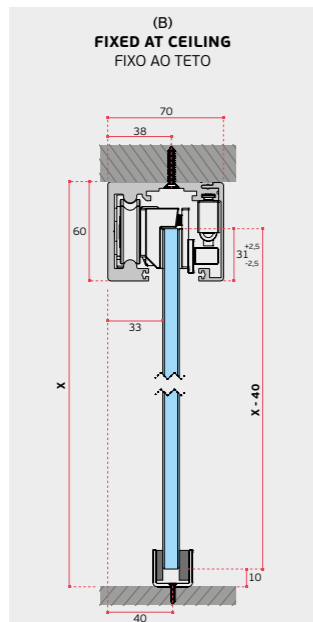
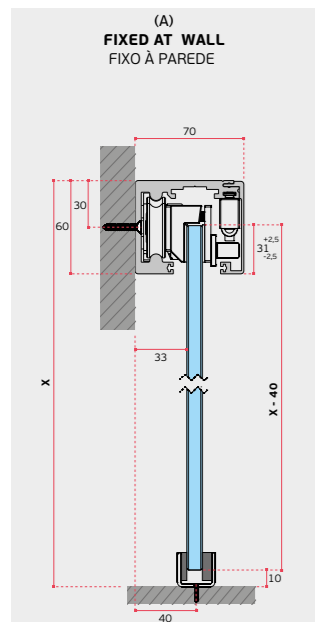

1. Carril superior em alumínio anodizado cor inox / Upper track in aluminium anodized color inox / Carril superior en aluminio anodizado color inox. (4000 / 6000mm)
2. Tampa frontal em alumínio anodizado cor inox / Front cover in aluminium anodized color inox / Tapa frontal en aluminio anodizado color inox. (4000 / 6000mm)
3. Tampa lateral em aço inoxidável / Side cover in stainless steel / Tapa lateral en acero inoxidable.

4. Ajuste de altura +- 5mm / Height adjustment +- 5mm / Ajuste de altura +- 5mm.
5. Bloqueio do ajuste em altura / Height adjustment lock / Bloqueo del ajuste de altura

6. Carros em aço inoxidável, permite utilização no exterior / Stainless steel trucks, allows outdoor use / Carros en acero inoxidable, permite uso en exteriores.

7. Botante em aço inoxidável, fácil de instalar, mesmo no final da aplicação / Stainless steel stoppers, easy to install, even at the end of the application / Tapa de acero inoxidable, fácil de instalar, incluso al final de la aplicación.

8. Vidro laminado ou temperado de 8 a 12mm de espessura com peso máximo de 80kg sem necessidade de entalhes / Laminated or tempered glass from 8 to 12mm thick with a maximum weight of 80kg without the need for cutouts / Cristal laminado o templado de 8 a 12mm de espesor con un peso máximo de 80kg sin necesidad de taladros.

9. Guia de pavimento para vidro com espessura ajustável em aço inoxidável / Floor guide for glass with adjustable thickness in stainless steel / Guia de piso para cristal con espesor ajustable en acero inoxidable.

10. Sistema de fecho suave com amortecedor de ar para portas até 80kg. Curso de 100mm e caixa metálica / Soft close system with air damper for 80kg doors. Stroke of 100mm and metallic case / Sistema de cierre suave con amortiguador de aire para puertas hasta 80kg. Carrera de 100 mm y caja metálica.

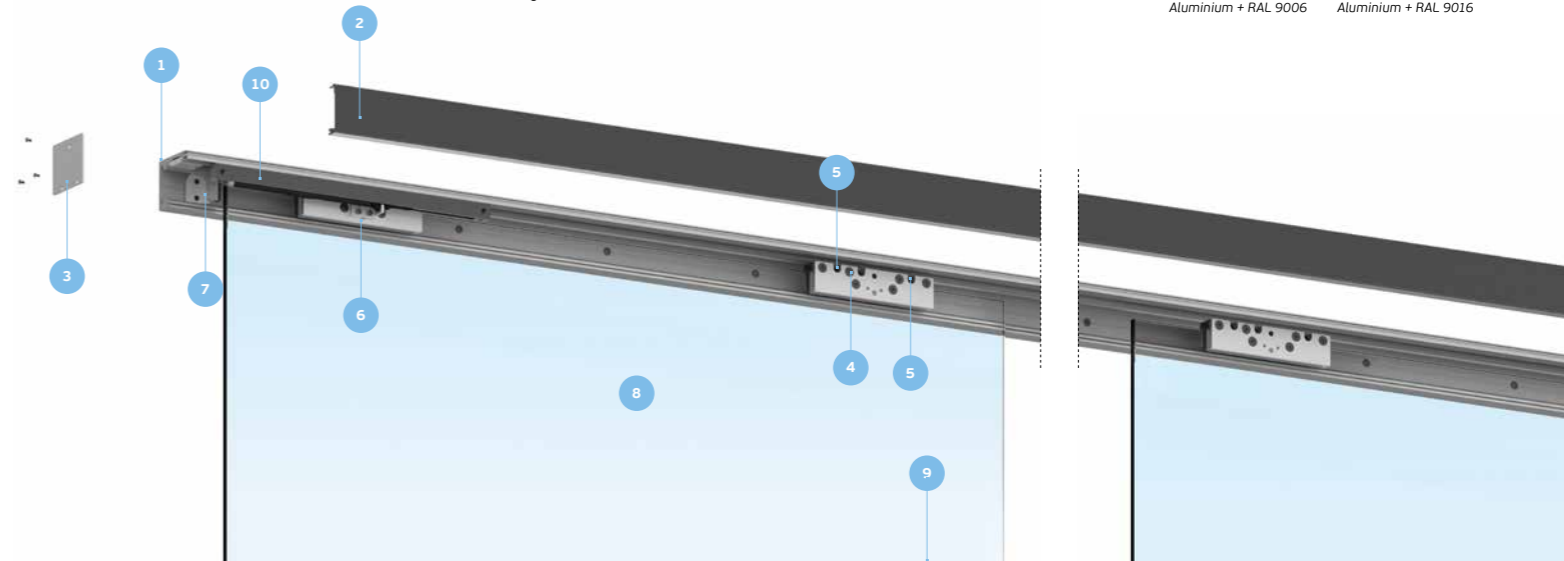

ACABAMENTOS DISPONÍVEIS / AVAILABLE FINISHINGS / ACABADOS DISPONIBLES.

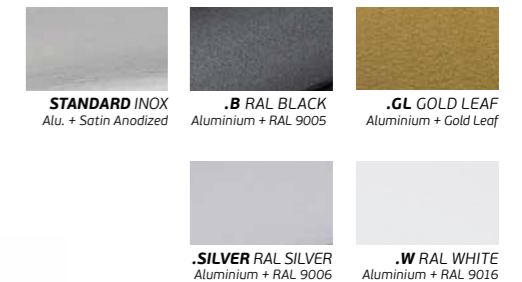

(A) FIXO À PAREDE /
FIXED AT WALL / FIJADO A LA PARED.

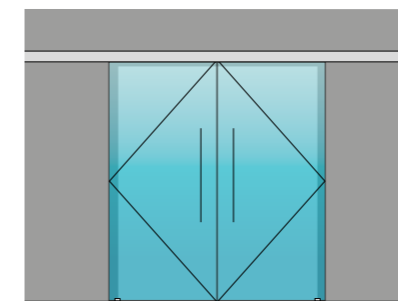

IN.15.703.S.4000
IN.15.703.S.6000
Sistema de porta de correr /
Sliding door system /
Sistema de puerta corredera.
(4000/6000mm)

(B) FIXO NO TETO /
FIXED ON THE CEILING / FIJADO EN EL TECHO.

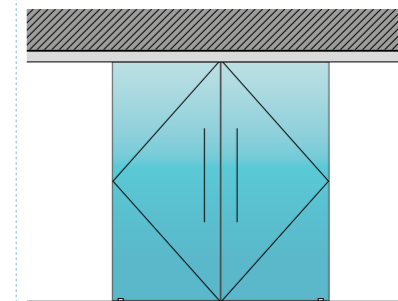

IN.15.703.S.4000
IN.15.703.S.6000
Sistema de porta de correr /
Sliding door system /
Sistema de puerta corredera.
(4000/6000mm)

(C) FIXO AO TETO COM PAINEL DE VIDRO /
FIXED TO THE CEILING WITH GLASS PANEL /
FIJACIÓN AL TECHO CON PANEL DE CRISTAL.

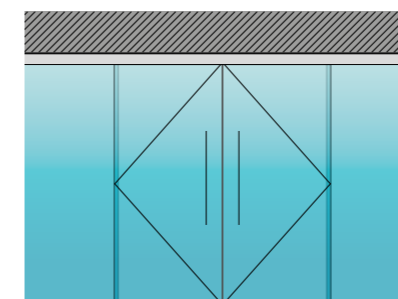

IN.15.703.S.4000
IN.15.703.S.6000
Sistema de porta de correr /
Sliding door system /
Sistema de puerta corredera.
(4000/6000mm)

IN.15.707.4000
IN.15.707.6000
Carril para suspensão no vidro fixo /
Track for suspension on fixed glass /
Carril para sujetar al cristal fijo.

(D) FIXO NO VIDRO /
FIXED ON THE GLASS / FIJADO EN EL CRISTAL

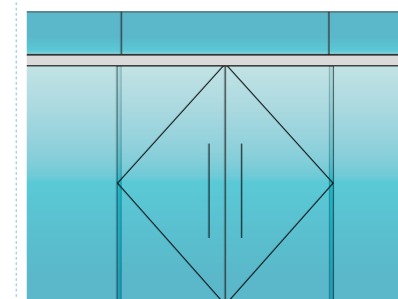

IN.15.703.S.4000
IN.15.703.S.6000
Sistema de porta de correr /
Sliding door system /
Sistema de puerta corredera.
(4000/6000mm)

IN.15.707.4000
IN.15.707.6000
Carril para suspensão no vidro fixo /
Track for suspension on fixed glass /
Carril para sujetar al cristal fijo.

LINEAR SINCRO DOUBLE DOORS

SISTEMAS MANUAIS PARA PORTAS DE CORRER COM CARRIL DE ALUMÍNIO / MANUAL SLIDING DOOR SYSTEMS WITH ALUMINIUM TRACK / SISTEMAS MANUALES PARA PUERTAS CORREDERAS CON CARRIL DE ALUMINIO /

LINEAR SINCRO DOUBLE DOORS

NO SISTEMA DE PORTA DUPLA SINCRONIZADA AS PORTAS ABREM E FECHAM SIMULTANEAMENTE SENDO OPERADAS MANUALMENTE. UM CABO DE AÇO ENCARRÉGA-SE DE TRANSMISSÃO DE MOVIMENTOS. O DESLIZE DAS PORTAS É SUAVE E CRIA UMA SENSÇÃO DE MOVIMENTO TRANSPARENTE.

IN THE SYNCHRONIZED DOUBLE DOOR SYSTEM THE DOORS OPEN AND CLOSE SIMULTANEOUSLY BEING MANUALLY OPERATED. A STAINLESS STEEL CABLE IS RESPONSIBLE FOR TRANSMITTING MOVEMENTS. THE SLIDING OF THE DOORS IS SMOOTH AND CREATES A SENSATION OF TRANSPARENT MOVEMENT.

EN EL SISTEMA DE DOBLE PUERTA SINCRONIZADA LAS PUERTAS SE ABREN Y CIERRAN SIMULTANEAMENTE SIENDO ACCIONADAS MANUALMENTE. UN CABLE DE ACERO ES EL ENCARGADO DE TRANSMITIR LOS MOVIMIENTOS. EL DESLIZAMIENTO DE LAS PUERTAS ES SUAVE Y CREA UNA SENSACIÓN DE MOVIMIENTO TRANSPARENTE.

Sistema manual para portas sincronizadas. Indicado para vãos de grandes dimensões. Pode ser aplicado em portas duplas de vidro, madeira ou metal, até um peso máximo de 150kg por porta. Não são necessários entalhes.

Manual system for synchronized doors. Suitable for large spans. Can be applied to double glass, timber or metal doors, up to maximum weight of 150kg per door. No cutouts are required.

Sistema manual para puertas sincronizadas. Indicado para grandes vanos. Puede ser aplicado en puertas dobles de cristal, madera o metal, hasta un peso máximo de 150kg por puerta. No se necesitan taladros.

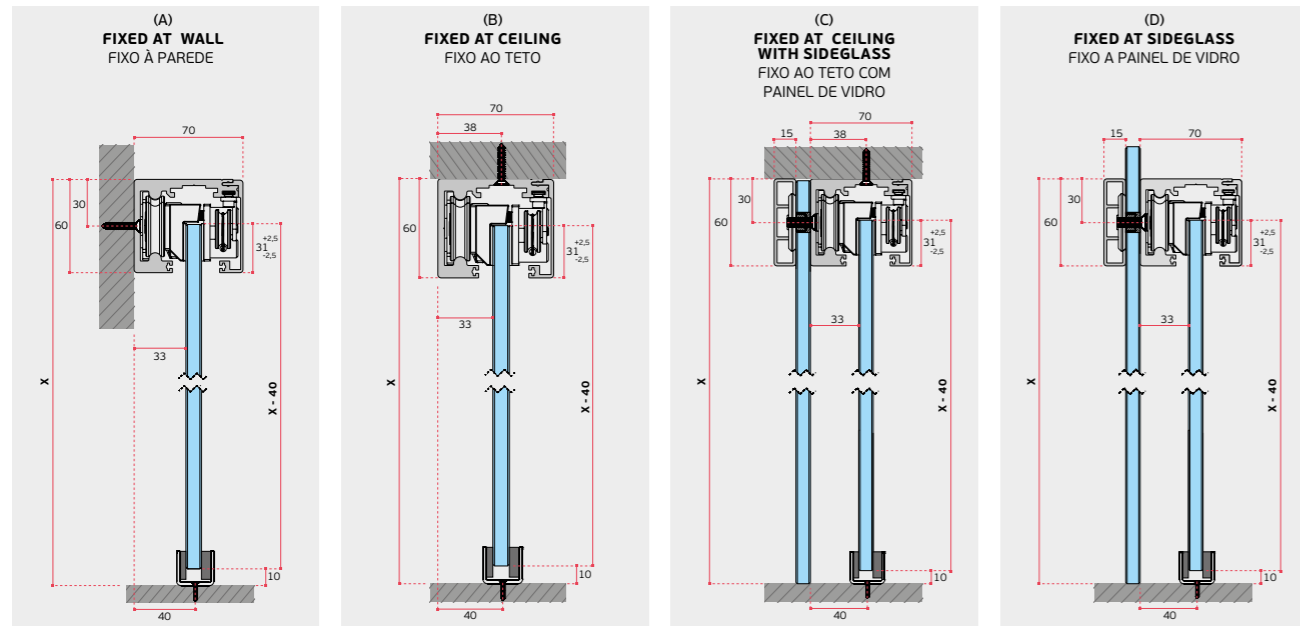

LINEAR SINCRO FOR DOUBLE GLASS DOORS

ACABAMENTOS DISPONÍVEIS / AVAILABLE FINISHINGS / ACABADOS DISPONIBLES.

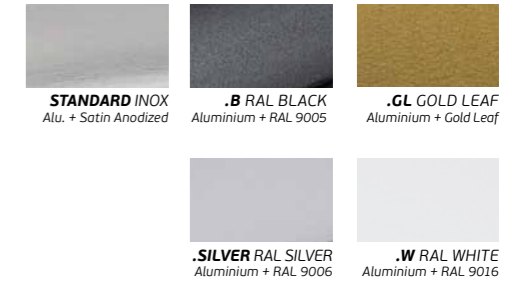

- Carril superior em alumínio anodizado cor inox / Upper track in aluminium anodized color inox / Carril superior en aluminio anodizado color inox. (4000 / 6000mm)**
- Tampa frontal em alumínio anodizado cor inox / Front cover in aluminium anodized color inox / Tapa frontal en aluminio anodizado color inox. (4000 / 6000mm)**
- Tampa lateral em aço inoxidável / Side cover in stainless steel / Tapa lateral en acero inoxidable.**
- Ajuste de altura +/- 5mm / Height adjustment +/- 5mm / Ajuste de altura +/- 5mm.**
- Bloqueio do ajuste em altura / Height adjustment lock / Bloqueo del ajuste de altura.**
- Carros em aço inoxidável, permite utilização no exterior / Stainless steel trucks, allows outdoor use / Carros en acero inoxidable, permite uso en exteriores.**
- Batente em aço inoxidável, fácil de instalar, mesmo no final da aplicação / Stainless steel stopper, easy to install, even at the end of the application / Tapa de acero inoxidable, fácil de instalar, incluso al final de la aplicación.**
- Vidro laminado ou temperado de 8 a 12mm de espessura com peso máximo de 150kg sem necessidade de entalhes / Laminated or tempered glass from 8 to 12mm thick with a maximum weight of 150kg without the need for cutouts / Cristal laminado o templado de 8 a 12mm de espesor con un peso máximo de 150kg sin necesidad de taladros.**
- Botante em aço inoxidável, fácil de instalar, mesmo no final da aplicação / Stainless steel stopper, easy to install, even at the end of the application / Tapa de acero inoxidable, fácil de instalar, incluso al final de la aplicación.**
- Guia de pavimento para vidro com espessura ajustável em aço inoxidável / Floor guide for glass with adjustable thickness in stainless steel / Guía de piso para cristal con espesor ajustable en acero inoxidable.**
- Sistema de roldanas que sincronizam o movimento de ambas as portas / Pulley system that synchronizes the movement of both doors / Sistema de poleas que sincroniza el movimiento de ambas puertas.**
- O cabo de aço é o elemento responsável pela transmissão do movimento / The steel cable is the element responsible for transmitting the movement / El cable de acero es el elemento encargado de transmitir el movimiento.**

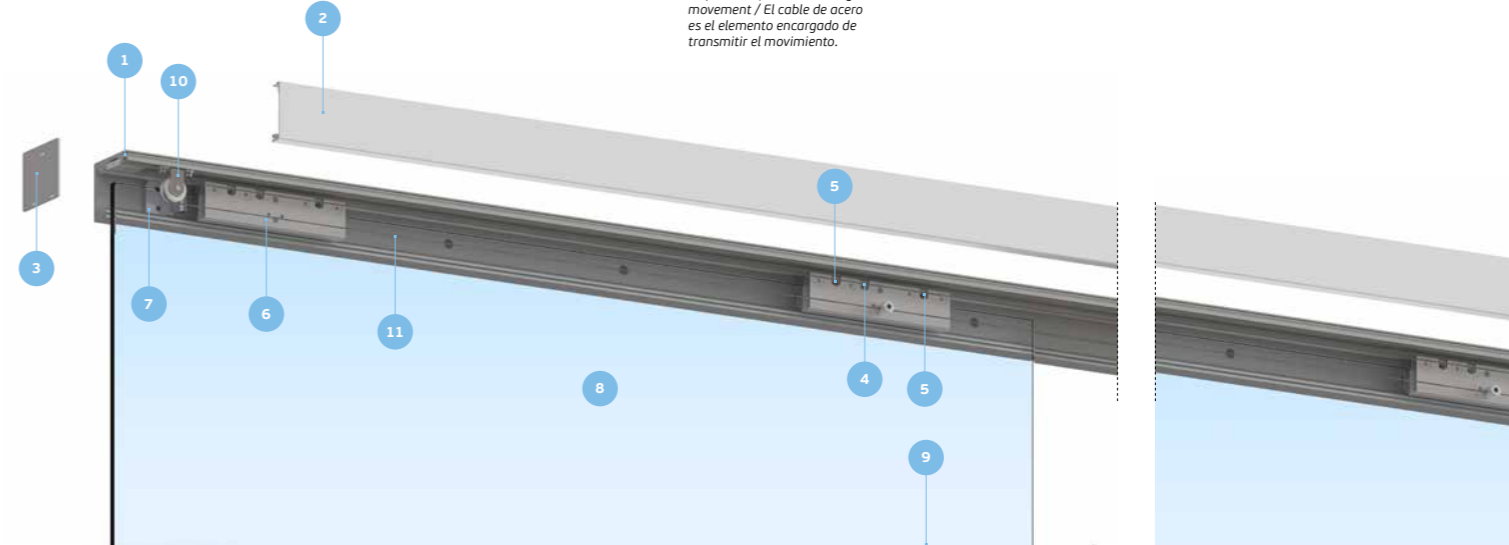

EN1527

(A) FIXO À PAREDE / FIXED AT WALL / FIJADO A LA PARED.

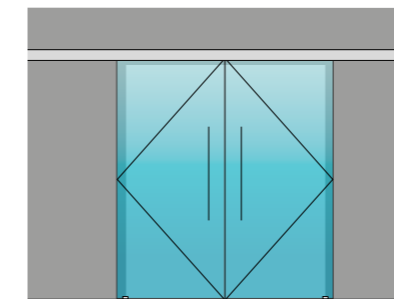

IN.15.708.4000
IN.15.708.6000
Sistema de porta de correr / Sliding door system / Sistema de puerta corredera. (4000/6000mm)

(B) FIXO NO TETO / FIXED ON THE CEILING / FIJADO EN EL TECHO.

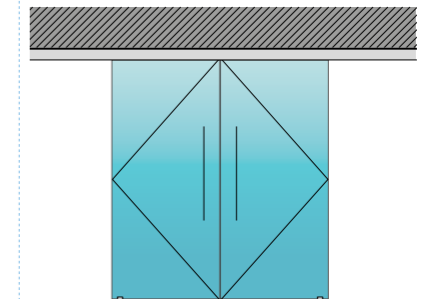

IN.15.708.4000
IN.15.708.6000
Sistema de porta de correr / Sliding door system / Sistema de puerta corredera. (4000/6000mm)

(C) FIXO AO TETO COM PAINEL DE VIDRO / FIXED TO THE CEILING WITH GLASS PANEL / FIJACIÓN AL TECHO CON PANEL DE CRISTAL.

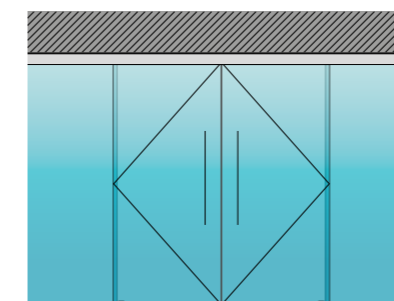

IN.15.708.4000
IN.15.708.6000
Sistema de porta de correr / Sliding door system / Sistema de puerta corredera. (4000/6000mm)

IN.15.707.4000
IN.15.707.6000
Carril para suspensão no vidro fixo / Track for suspension on fixed glass / Carril para sujetar al cristal fijo.

(D) FIXO NO VIDRO / FIXED ON THE GLASS / FIJADO EN EL CRISTAL.

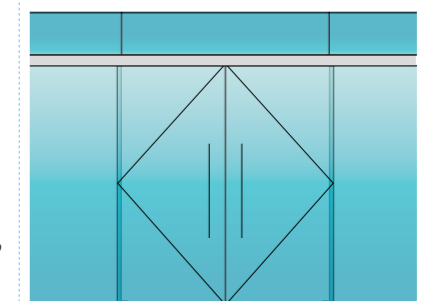

IN.15.708.4000
IN.15.708.6000
Sistema de porta de correr / Sliding door system / Sistema de puerta corredera. (4000/6000mm)

IN.15.707.4000
IN.15.707.6000
Carril para suspensão no vidro fixo / Track for suspension on fixed glass / Carril para sujetar al cristal fijo.

LINEAR FIT SINGLE DOOR

SISTEMAS MANUAIS PARA PORTAS DE CORRER COM CARRIL DE ALUMÍNIO / MANUAL SLIDING DOOR SYSTEMS WITH ALUMINIUM TRACK / SISTEMAS MANUALES PARA PUERTAS CORREDERAS CON CARRIL DE ALUMINIO /

LINEAR FIT SINGLE DOOR

A PERFEITA COMBINAÇÃO DAS ROLDANAS EM AÇO INOXIDÁVEL COM O SISTEMA DE PERFIL DE ALUMÍNIO.

THE PERFECT COMBINATION OF STAINLESS STEEL ROLLERS WITH THE ALUMINIUM PROFILE SYSTEM.

LA COMBINACIÓN PERFECTA DE POLEAS DE ACERO INOXIDABLE CON EL SISTEMA DE PERFILES DE ALUMINIO.



LINEAR FIT FOR SINGLE GLASS DOOR

1. Carril superior em alumínio anodizado cor inox / Upper track in aluminium anodized color inox / Carril superior en aluminio anodizado color inox. (2000/3000/4000mm)

2. Tampa frontal em alumínio anodizado cor inox / Front cover in aluminium anodized color inox / Tapa frontal en aluminio anodizado color inox. (2000/3000/4000mm)

3. Tampa lateral em aço inoxidável / Side cover in stainless steel / Tapa lateral en acero inoxidable.

4. Ajuste de altura +- 5mm / Height adjustment +- 5mm / Ajuste de altura +- 5mm.

5. Bloqueio do ajuste em altura / Height adjustment lock / Bloqueo del ajuste de altura.

6. Carros em aço inoxidável, permite utilização no exterior / Stainless steel trucks, allows outdoor use / Carros en acero inoxidable, permite uso en exteriores.

7. Botente em aço inoxidável, fácil de instalar, mesmo no final da aplicação / Stainless steel stoppers, easy to install, even at the end of the application / Tapa de acero inoxidable, fácil de instalar, incluso al final de la aplicación.

8. Vidro laminado ou temperado de 8 a 12mm de espessura com peso máximo de 150kg sem necessidade de entalhes / Laminated or tempered glass from 8 to 12mm thick with a maximum weight of 150kg without the need for cutouts / Cristal laminado o templado de 8 a 12mm de espesor con un peso máximo de 150kg sin necesidad de taladros.

9. Guia de pavimento para vidro com espessura ajustável em aço inoxidável / Floor guide for glass with adjustable thickness in stainless steel / Guía de piso para cristal con espesor ajustable en acero inoxidable.

10. As pinças FIT foram desenvolvidas para reduzir a folga do vidro à parede ao mínimo possível / FIT clamps were developed to reduce the gap between the glass and the wall to the minimum possible / Las pinzas FIT se desarrollaron para reducir al mínimo posible el espacio entre el cristal y la pared.

ACABAMENTOS DISPONÍVEIS / AVAILABLE FINISHINGS / ACABADOS DISPONIBLES.



EN1527

Sistema manual com suportes em aço inoxidável que permitem um afastamento do vidro à parede de apenas 12mm. Pode ser aplicado em portas simples de vidro até um peso máximo de 150kg por porta. Neste modelo, a porta necessita de entalhes.

Manual system with stainless steel brackets that allows a distance of glass to the wall of only 12mm. Can be applied on single glass doors up to maximum of 150kg per door. In this model, the door needs cutouts.

Sistema manual con soportes de acero inoxidable que permiten un alejamiento del cristal a la pared de apenas 12mm. Puede ser aplicado en puertas simples de cristal hasta un peso máximo de 150kg por puerta. En este modelo, la puerta necesita de taladros.

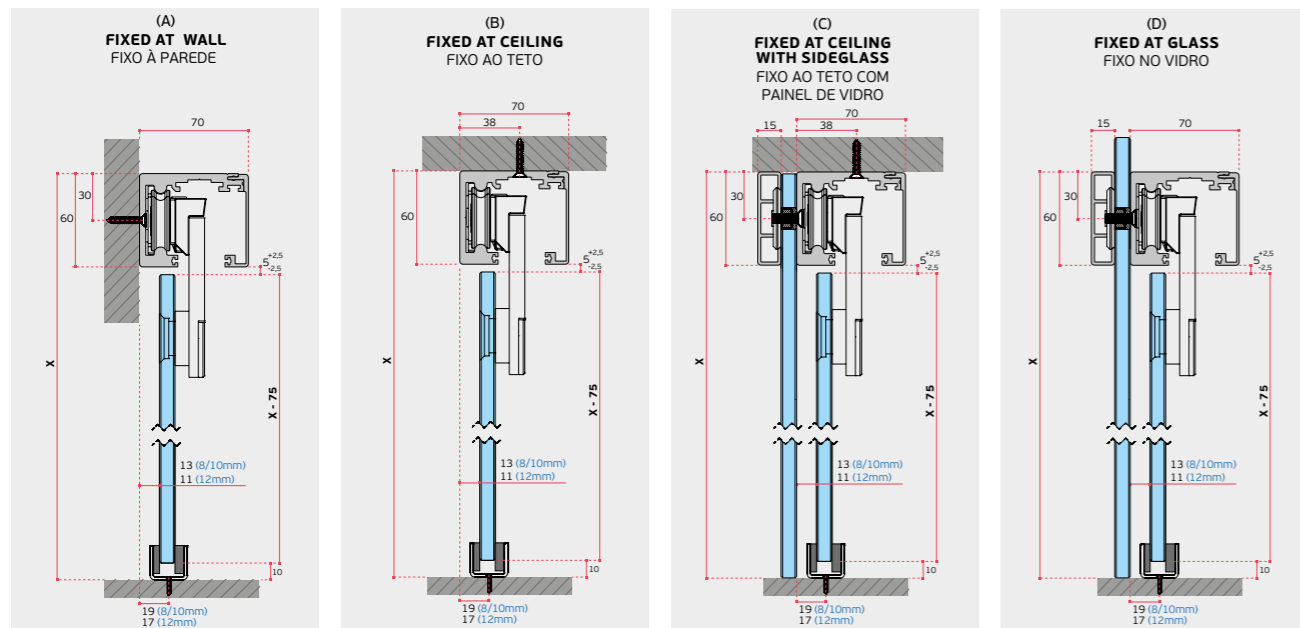

(A) FIXO À PAREDE / FIXED AT WALL / FIJADO A LA PARED.

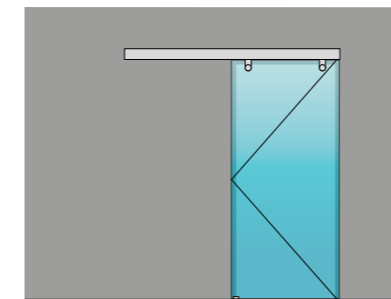

IN.15.709.2000
IN.15.709.3000
IN.15.709.4000
Sistema de porta de correr / Sliding door system / Sistema de puerta corredera. (2000/3000/4000mm)

(B) FIXO NO TETO / FIXED ON THE CEILING / FIJADO EN EL TECHO.

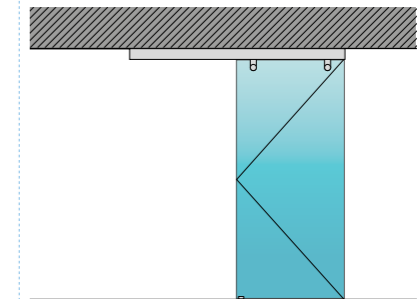

IN.15.709.2000
IN.15.709.3000
IN.15.709.4000
Sistema de porta de correr / Sliding door system / Sistema de puerta corredera. (2000/3000/4000mm)

(C) FIXO AO TETO COM PAINEL DE VIDRO / FIXED TO THE CEILING WITH GLASS PANEL / FIJACIÓN AL TECHO CON PANEL DE CRISTAL.

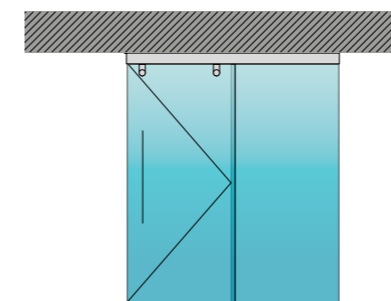

IN.15.709.2000
IN.15.709.3000
IN.15.709.4000
Sistema de porta de correr / Sliding door system / Sistema de puerta corredera. (2000/3000/4000mm)

IN.15.707.2000
IN.15.707.3000
IN.15.707.4000
Carril para suspensão no vidro fixo / Track for suspension on fixed glass / Carril para sujetar al cristal fijo.

(D) FIXO NO VIDRO / FIXED ON THE GLASS / FIJADO EN EL CRISTAL.

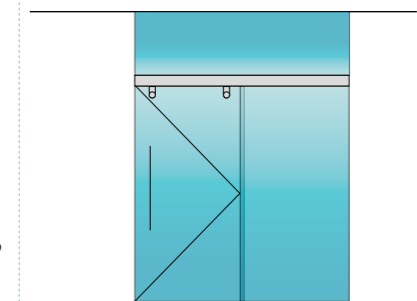

IN.15.709.2000
IN.15.709.3000
IN.15.709.4000
Sistema de porta de correr / Sliding door system / Sistema de puerta corredera. (2000/3000/4000mm)

IN.15.707.2000
IN.15.707.3000
IN.15.707.4000
Carril para suspensão no vidro fixo / Track for suspension on fixed glass / Carril para sujetar al cristal fijo.

MECANO MANUAL SYSTEM

SISTEMAS MANUAIS PARA PORTAS DE CORRER COM CARRIL DE ALUMÍNIO /
MANUAL SLIDING DOOR SYSTEMS WITH ALUMINIUM TRACK /
SISTEMAS MANUALES PARA PUERTAS CORREDERAS CON CARRIL DE ALUMINIO /

MECANO SYSTEM

MANUAL SLIDING DOOR SYSTEMS

**SISTEMA PARA PORTAS DE
CORRER, DE FÁCIL INSTALAÇÃO
QUE NÃO NECESSITA DE ENTALHES
NA PORTA**

SYSTEM FOR SLIDING DOORS, EASY
INSTALLATION THAT DOES NOT
REQUIRE NOTCHES IN THE DOOR.

SISTEMA PARA PUERTAS
CORREDERAS, DE FÁCIL
INSTALACIÓN QUE NO NECESITA DE
TALADROS EN LA PUERTA.



MECANO MANUAL SYSTEM

SISTEMAS MANUAIS PARA PORTAS DE CORRER COM CARRIL DE ALUMÍNIO /
MANUAL SLIDING DOOR SYSTEMS WITH ALUMINIUM TRACK /
SISTEMAS MANUALES PARA PUERTAS CORREDERAS CON CARRIL DE ALUMINIO /

Sistema para portas de correr, de fácil instalação que não necessita de entalhes na porta.

Com altura ajustável (6mm), pode ser aplicado com portas duplas ou simples de vidro, madeira e metal, até um peso máximo de 80kg por porta.

O carril, com afinações frontais e, com 75mm de altura, permite que o sistema seja fixo à parede e ao tecto. Opção de fecho com amortecedor (SOFT). Possibilidade de fecho automático (AIR). Opção de portas sincronizadas (SINCRO). Várias cores disponíveis.
EN 1527:2013
100.000 ciclos de teste.



System for sliding doors, easy installation that does not require notches in the door.

With adjustable height (6mm), it can be applied with double or single doors of glass, wood and metal, up to a maximum weight of 80kg per door.

The track, with frontal adjustments and, at 75mm height, allows the system to be fixed to the wall and ceiling. Locking option with shock absorber (SOFT). Possibility of automatic closing (AIR). Synchronized ports option (SINCRO). Various colors available
EN 1527: 2013
100,000 test cycles.

Sistema para puertas correderas, de fácil instalación que no necesita de taladros en la puerta.

Con altura ajustable (6 mm), se puede aplicar con puertas dobles o simples de cristal, madera y metal, hasta un peso máximo de 80kg por puerta.

El carril, con afinaciones frontales y, con 75mm de altura, permite que el sistema sea fijo a la pared y al techo. Opción de cierre con amortiguador (SOFT). Posibilidad de cierre automático (AIR). Opción de puertos sincronizados (SINCRO). Diversos colores disponibles
EN 1527: 2013
100.000 ciclos de prueba.

1. Ajuste de altura +- 6mm /
Height adjustment +- 6mm /
Ajuste de altura +- 6mm.

2. Bloqueio do ajuste em altura / Locking of height adjustment / Bloqueo del ajuste de altura.

3. Carras com dupla roda de "POM" com rolamentos de esferas / "POM" double wheel trucks with ball bearings / Carras con rueda doble "POM" con rodamientos de bolas.

4. Carril superior em alumínio anodizado cor inox / Upper track in aluminium anodized inox color / Carril superior en aluminio anodizado color inox (2000/3000/4000mm).

5. Tampa frontal em alumínio anodizado cor inox / Front cover in aluminium anodized color inox / Tapa frontal en aluminio anodizado color inox. (2000/3000/4000mm).

6. Batente em alumínio com borracha para amortecimento, fácil de instalar, mesmo no final da aplicação / Aluminum stoppers with rubber for cushioning, easy to install, even at the end of the application / Topes de aluminio con goma para amortiguación, fácil de instalar, incluso al final de la aplicación.

7. Vidro laminado ou temperado de 8 a 10mm de espessura com peso máximo de 80KG sem necessidade de entalhes / Laminated or tempered glass from 8 to 10mm thick with a maximum weight of 80KG without the need for cutouts / Cristal laminado o templado de 8 a 10mm de espesor con un peso máximo de 80KG sin necesidad de muescas.



A MECANO AIR AUTOMATIC



Sistema manual com fecho automático silencioso. Pode ser aplicado em portas simples até um peso máx. de 80kg por porta. Fecho silencioso com amortecedor, que reduz a velocidade da porta no fecho final. O fecho é efectuado sem ruído.

Manual system with silent automatic closing. Can be applied on single doors up to max. 80kg/door. Silent closure with damper, which reduces the speed of the door in the final closure. The closing is effected without noise.

Sistema manual con cierre automático silencioso. Puede ser aplicado en puertas simples hasta un peso máx. de 80kg/ puerta. Cierre silencioso con amortiguador, que reduce la velocidad de la puerta en el cierre final. El cierre se realiza sin ruido.

S MECANO STANDARD



Sistema standard manual para portas simples de vidro ou madeira até um peso máx. de 80kg por porta.

Manual standard system for single glass or wood doors up to max. of 80kg/door.

Sistema estándar manual para puertas simples de cristal o madera hasta un peso máx. de 80kg/puerta.

M MECANO SOFT



Sistema manual com fecho suave. Pode ser aplicado em portas simples de vidro ou madeira até um peso máx. de 80kg por porta. Fecho silencioso com amortecedor, que reduz a velocidade da porta no fecho final. O fecho é efectuado sem ruído.

Manual system with soft closing. It can be applied on single glass or wood doors up to a maximum weight of 80kg/door. Silent closure with damper, which reduces the speed of the door in the final closure. The closing is effected without noise.

Sistema manual con cierre suave. Puede ser aplicado en puertas simples de cristal o madera hasta un peso máx. de 80kg/puerta. Cierre silencioso con amortiguador, que reduce la velocidad de la puerta en el cierre final. El cierre se realiza sin ruido.

G MECANO SINCRO



Sistema manual para portas sincronizadas. Pode ser aplicado em portas duplas de vidro ou madeira até um peso máximo de 80kg por porta. Indicado para vãos de grandes dimensões.

Manual system for synchronized doors. It can be applied on double glass or timber doors up to maximum weight of 80kg per door. Suitable for large spans.

Sistema manual para puertas sincronizadas. Puede ser aplicado en puertas dobles de cristal o madera hasta un peso máximo de 80kg por puerta. Indicado para grandes vanos.

MECANO AIR SINGLE DOOR

SISTEMAS MANUAIS PARA PORTAS DE CORRER COM CARRIL DE ALUMÍNIO / MANUAL SLIDING DOOR SYSTEMS WITH ALUMINIUM TRACK / SISTEMAS MANUALES PARA PUERTAS CORREDERAS CON CARRIL DE ALUMINIO /

MECANO AIR SINGLE DOOR

SISTEMA DE FECHO AUTOMÁTICO COM UM PISTÃO TELESCÓPICO PNEUMÁTICO.

AUTOMATIC CLOSING SYSTEM WITH A PNEUMATIC TELESCOPIC PISTON.

SISTEMA DE CIERRE AUTOMÁTICO CON PISTÓN TELESCÓPICO NEUMÁTICO.



MECANO AIR **80 Kg** **8-10 mm** FOR SINGLE GLASS DOOR

ACABAMENTOS DISPONÍVEIS / AVAILABLE FINISHINGS / ACABADOS DISPONIBLES.

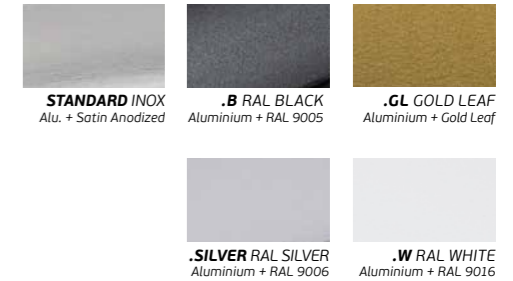

1. Carril superior em alumínio anodizado cor inox / Upper track in aluminium anodized color inox / Carril superior en aluminio anodizado color inox. (2000mm)
2. Ajuste de altura +/- 6mm / Height adjustment +/- 6mm / Ajuste de altura +/- 6mm.
3. Bloqueio do ajuste em altura / Height adjustment lock / Bloqueo del ajuste de altura.
4. Carros com dupla roda de "POM" com rolamentos de esferas / "POM" double wheel trucks with ball bearings / Carros con rueda doble "POM" con rodamientos de bolas.
5. Batente em alumínio com borracha para amortecimento. fácil de instalar, mesmo na final da aplicação / Aluminum stopper with rubber for cushioning. Easy to install, even at the end of the application / Topes de aluminio con goma para amortiguación. Fácil de instalar, incluso al final de la aplicación.
6. Vidro laminado ou temperado de 8 a 10mm de espessura com peso máximo de 80kg sem necessidade de entalhes / Laminated or tempered glass from 8 to 10mm thick with a maximum weight of 80kg without the need for cutouts / Cristal laminado o templado de 8 a 10mm de espesor con un peso máxima de 80kg sin necesidad de taladros.
7. Guia de pavimento para vidro com espessura ajustável em aço inoxidável / Floor guide for glass with adjustable thickness in stainless steel / Guía de piso para cristal con espesor ajustable en acero inoxidable.
8. Sistema de fecho automático com um pistão telescópico pneumático / Automatic closing system with a pneumatic telescopic piston / Sistema de cierre automático con pistón telescópico neumático.
9. Sistema magnético de retenção na abertura (opcional) / Magnetic retention system in the opening (optional) / Sistema de retención magnética en la apertura (opcional).

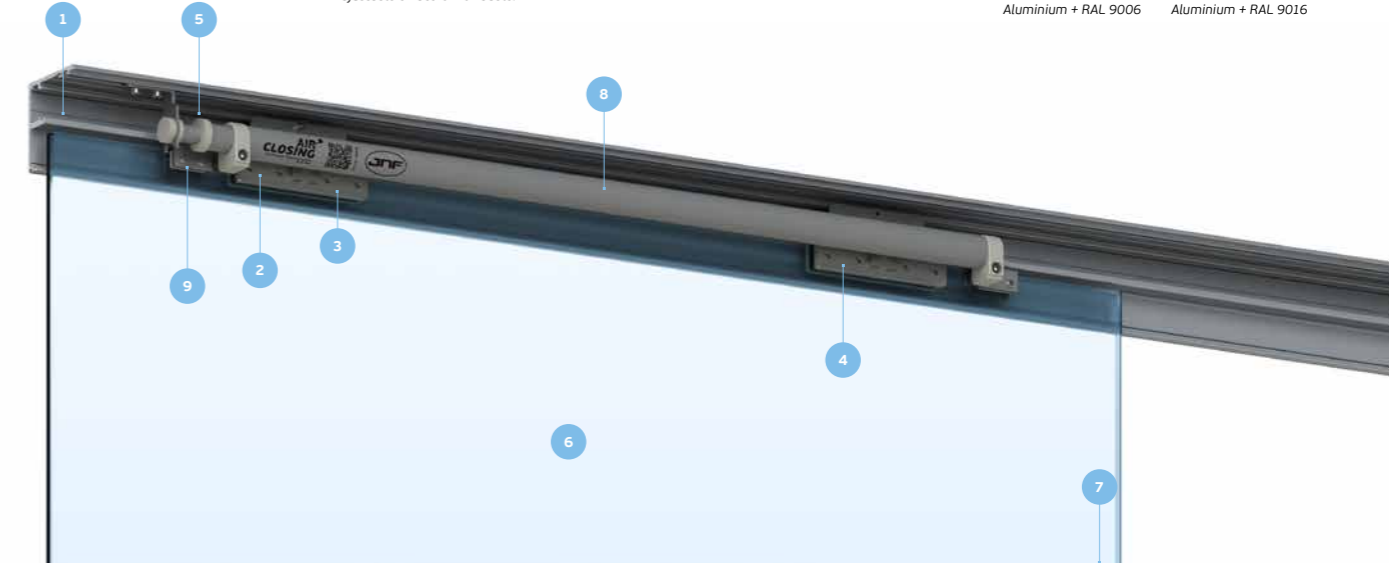

EN1527 - 6 | 2 | - | 1 | 2 | - | 1 | 2

Sistema manual com fecho automático silencioso. Pode ser aplicado em portas simples até um peso máx. de 80kg por porta. Fecho silencioso com amortecedor, que reduz a velocidade da porta no fecho final. O fecho é efectuado sem ruído.

Manual system with silent automatic closing. Can be applied on single doors up to max. 80kg/door. Silent closure with damper, which reduces the speed of the door in the final closure. The closing is effected without noise.

Sistema manual con cierre automático silencioso. Puede ser aplicado en puertas simples hasta un peso máx. de 80kg/ puerta. Cierre silencioso con amortiguador, que reduce la velocidad de la puerta en el cierre final. El cierre se realiza sin ruido.

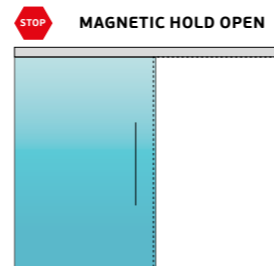
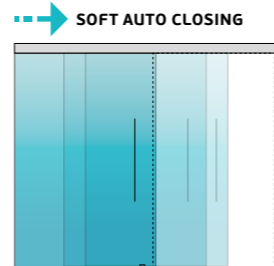
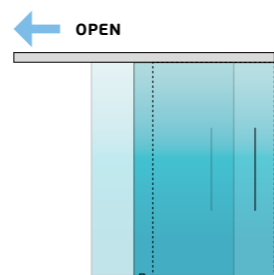

(A) FIXO À PAREDE / FIXED AT WALL / FIJADO A LA PARED.

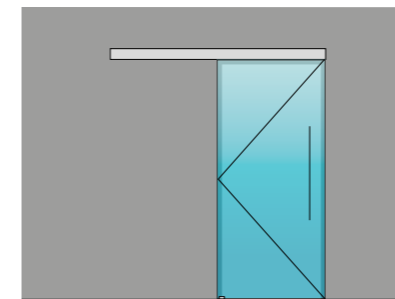

IN.15.742.2000 Sistema de porta de correr / Sliding door system / Sistema de puerta corredera. (2000mm)

(B) FIXO NO TETO / FIXED ON THE CEILING / FIJADO EN EL TECHO.

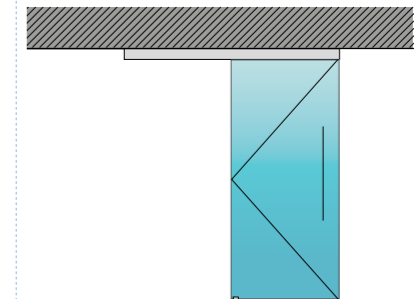

IN.15.742.2000 Sistema de porta de correr / Sliding door system / Sistema de puerta corredera. (2000mm)

(C) FIXO AO TETO COM PAINEL DE VIDRO / FIXED TO THE CEILING WITH GLASS PANEL / FIJACIÓN AL TECHO CON PANEL DE CRISTAL.

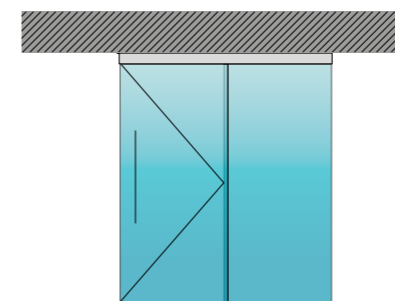

IN.15.742.2000 Sistema de porta de correr / Sliding door system / Sistema de puerta corredera. (2000mm)

IN.15.427.1500 Carril para suspensão no vidro fixo / Track for suspension on fixed glass / Carril para sujetar al cristal fijo.

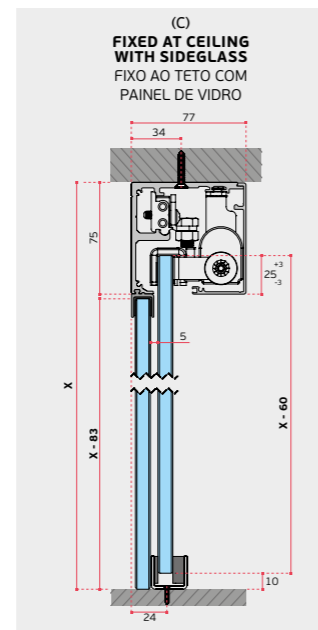
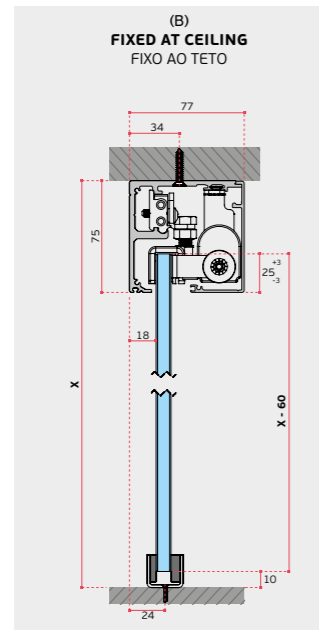
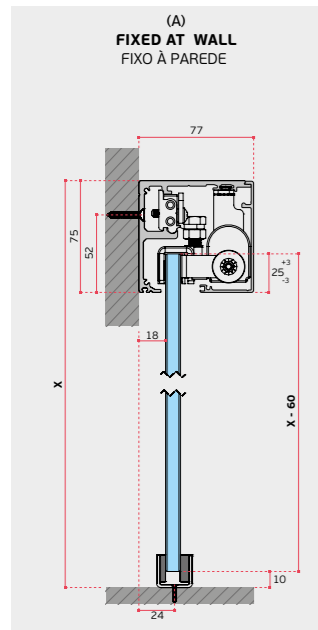

MECANO STANDARD SINGLE DOOR

SISTEMAS MANUAIS PARA PORTAS DE CORRER / MANUAL SLIDING DOOR SYSTEMS / SISTEMAS MANUALES PARA PUERTAS CORREDERAS.

MECANO STANDARD SINGLE DOOR

A SIMPLICIDADE DE UM SISTEMA DE PORTA DE CORRER COM CARGA MÁXIMA DE 80KG, COM A VANTAGEM DO VIDRO NÃO TER ENTALHES.

THE SIMPLICITY OF A SLIDING DOOR SYSTEM WITH A MAXIMUM LOAD OF 80KG, WITH THE ADVANTAGE OF THE GLASS WITHOUT CUTOUTS.

LA SIMPLICIDAD DE UN SISTEMA DE PUERTAS CORREDERAS CON UNA CARGA MÁXIMA DE 80KG, CON LA VENTAJA DEL CRISTAL SIN TALADROS.



MECANO STANDARD **S** 80 Kg 8-10 mm FOR GLASS DOORS

1. Carril superior em alumínio anodizado cor inox / Upper track in aluminium anodized color inox / Carril superior en aluminio anodizado color inox. (2000/3000/4000mm)

2. Ajuste de altura +- 6mm / Height adjustment +- 6mm / Ajuste de altura +- 6mm.

3. Bloqueio do ajuste em altura / Height adjustment lock / Bloqueo del ajuste de altura.

4. Carros com dupla roda de "POM" com rolamentos de esferas / "POM" double wheel trucks with ball bearings / Carros con rueda doble "POM" con rodamientos de bolas.

5. Batente em alumínio com borracha para amortecimento. Fácil de instalar, mesmo no final da aplicação / Aluminium stoppers with rubber for cushioning. Easy to install, even at the end of the application / Tapes de aluminio con goma para amortiguación. Fácil de instalar, incluso al final de la aplicación.

6. Vidro laminado ou temperado de 8 a 10mm de espessura com peso máximo de 80kg sem necessidade de entalhes / Laminated or tempered glass from 8 to 10mm thick with a maximum weight of 80kg without the need for cutouts / Cristal laminado o templado de 8 a 10mm de espesor con un peso máximo de 80kg sin necesidad de taladros.

7. Guia de pavimento para vidro com espessura ajustável em aço inoxidável / Floor guide for glass with adjustable thickness in stainless steel / Guia de piso para cristal con espesor ajustable en acero inoxidable.

8. Tampa frontal em alumínio anodizado cor inox / Front cover in aluminium anodized color inox / Tapa frontal en aluminio anodizado color inox. (2000/3000/4000mm)

9. Tampa lateral em aço inoxidável / Side cover in stainless steel / Tapa lateral en acero inoxidable.

ACABAMENTOS DISPONÍVEIS / AVAILABLE FINISHINGS / ACABADOS DISPONIBLES.

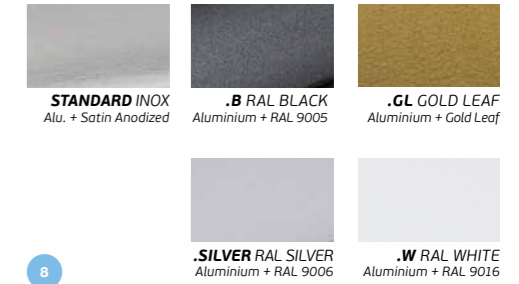

EN1527 - 6 | 2 | - | 1 | 2 | - | 1 | 3

Sistema standard manual para portas simples de vidro ou madeira até um peso máximo de 80kg por porta.

Manual standard system for single glass or timber doors up to a maximum weight of 80kg per door.

Sistema estándar manual para puertas simples de cristal o madera hasta un peso máximo de 80kg por puerta.

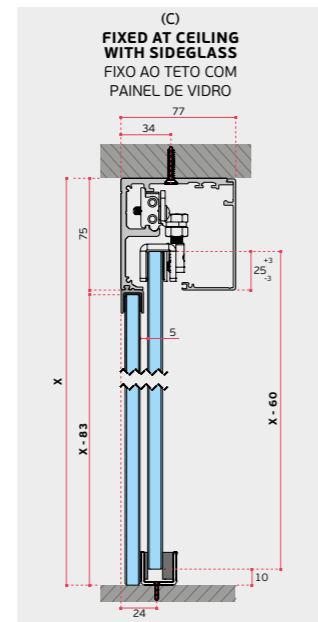
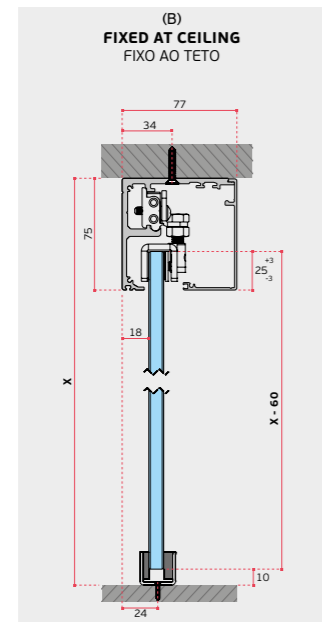
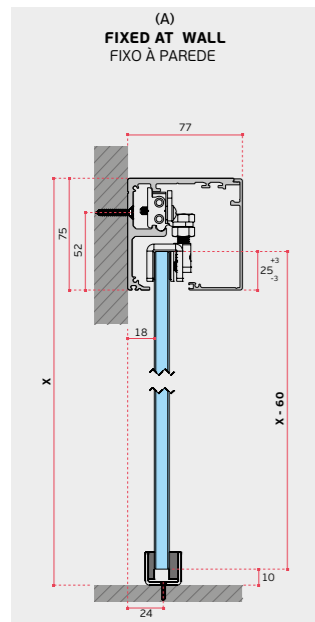

(A) FIXO À PAREDE / FIXED AT WALL / FIJADO A LA PARED.

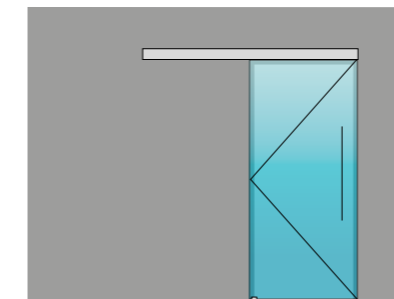

IN.15.740.2000
IN.15.740.3000
IN.15.740.4000
Sistema de porta de correr / Sliding door system / Sistema de puerta corredera. (2000 / 3000 / 4000mm)

(B) FIXO NO TETO / FIXED ON THE CEILING / FIJADO EN EL TECHO.

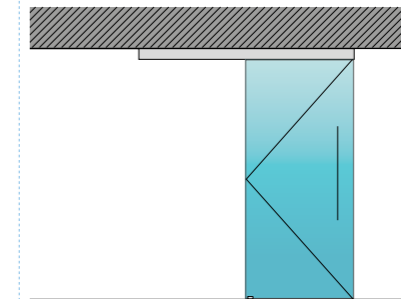

IN.15.740.2000
IN.15.740.3000
IN.15.740.4000
Sistema de porta de correr / Sliding door system / Sistema de puerta corredera. (2000 / 3000 / 4000mm)

(C) FIXO AO TETO COM PAINEL DE VIDRO / FIXED TO THE CEILING WITH GLASS PANEL / FIJACIÓN AL TECHO CON PANEL DE CRISTAL.

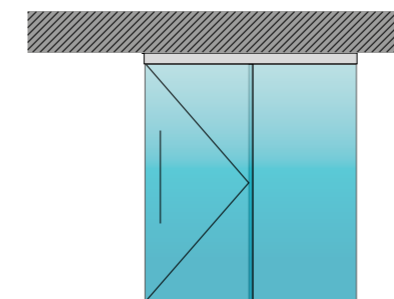

IN.15.740.2000
IN.15.740.3000
IN.15.740.4000
Sistema de porta de correr / Sliding door system / Sistema de puerta corredera. (2000 / 3000 / 4000mm)

IN.15.427.1500
Carril para suspensão no vidro fixo / Track for suspension on fixed glass / Carril para sujetar al cristal fijo.

MECANO SOFT SINGLE DOOR

SISTEMAS MANUAIS PARA PORTAS DE CORRER /
MANUAL SLIDING DOOR SYSTEMS /
SISTEMAS MANUALES PARA PUERTAS CORREDERAS.

MECANO SOFT SINGLE DOOR

A SUAVIDADE E AUSÊNCIA
DE RUÍDO DO SISTEMA
DE AMORTECIMENTO,
INSTALADO NUM SISTEMA
DE PORTAS DE CORRER, O
MECANO SOFT PERMITE
PORTAS ATÉ 80KG.

THE SMOOTHNESS AND NO
NOISE OF THE DAMPING
SYSTEM, IN A SLIDING DOOR
SYSTEM THE MECANO SOFT
ALLOWS DOORS TILL 80KG.

LA SUAVIDAD Y AUSENCIA
DE RUIDO DEL SISTEMA DE
AMORTIGUACIÓN, INSTALADO
EN UN SISTEMA DE PUERTA
CORREDERA, EL MECANO
SOFT PERMITE PUERTAS
HASTA 80KG.



Sistema manual com fecho
suave. Pode ser aplicado em
portas simples de vidro ou
madeira até um peso máximo
de 80kg por porta. Fecho
silencioso com amortecedor,
que reduz a velocidade da
porta no fecho final. O fecho é
efectuado sem ruído.

Manual system with soft closing.
It can be applied on single glass or
timbers doors up to a maximum
weight of 80kg per door. Silent
closure with damper, which
reduces the speed of the door in
the final closure. Closing is carried
out without noise.

Sistema manual con cierre suave.
Puede ser aplicado en puertas
simples de cristal o madera
hasta un peso máximo de 80kg
por puerta. Cierre silencioso con
amortiguador, que reduce la
velocidad de la puerta en el cierre
final. El cierre se realiza sin ruido.



**MECANO
SOFT**

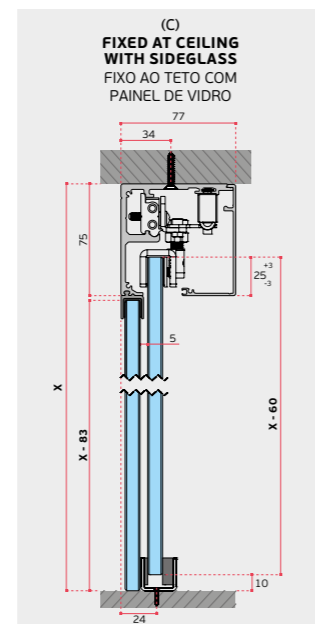
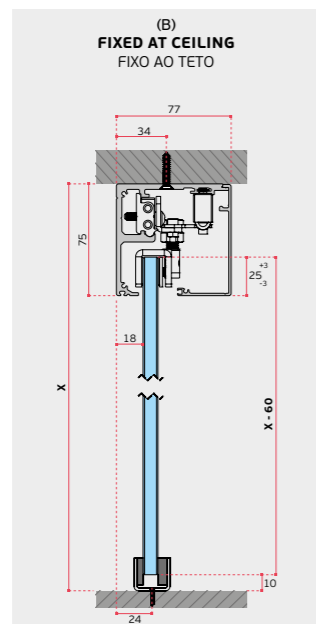
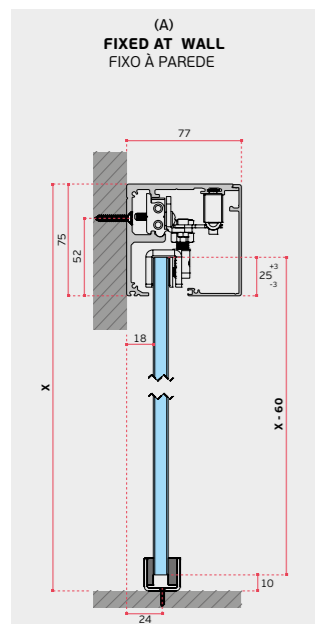

MECANO SOFT  **80 Kg** **8-10 mm** 
FOR GLASS DOORS

ACABAMENTOS DISPONÍVEIS /
AVAILABLE FINISHINGS / ACABADOS DISPONIBLES.

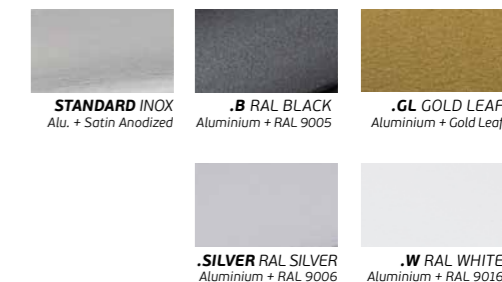

- Carril superior em alumínio anodizado cor inox / Upper track in aluminium anodized color inox / Carril superior en aluminio anodizado color inox. (2000/3000/4000mm)**
- Ajuste de altura +- 6mm / Height adjustment +- 6mm / Ajuste de altura +- 6mm.**
- Bloqueio do ajuste em altura / Height adjustment lock / Bloqueo del ajuste de altura**
- Carras com dupla roda de "POM" com rolamentos de esferas / "POM" double wheel trucks with ball bearings / Carras con rueda doble "POM" con rodamientos de bolas.**
- Batente em alumínio com borracha para amortecimento. Fácil de instalar, mesmo no final da aplicação / Aluminium stopper with rubber for cushioning. Easy to install, even at the end of the application / Topes de aluminio con goma para amortiguación. Fácil de instalar, incluso al final de la aplicación.**
- Vidro laminado ou temperado de 8 a 10mm de espessura com peso máximo de 80kg sem necessidade de entalhes / Laminated or tempered glass from 8 to 10mm thick with a maximum weight of 80kg without the need for cutouts / Cristal laminado o templado de 8 a 10mm de espesor con un peso máxima de 80kg sin necesidad de taladros.**
- Guia de pavimento para vidro com espessura ajustável em aço inoxidável / Floor guide for glass with adjustable thickness in stainless steel / Guía de piso para cristal con espesor ajustable en acero inoxidable.**
- Tampa frontal em alumínio anodizado cor inox / Front cover in aluminium anodized color inox / Tapa frontal en aluminio anodizado color inox. (2000/3000/4000mm)**
- Tampa lateral em aço inoxidável / Side cover in stainless steel / Tapa lateral en acero inoxidable.**
- Sistema de fecho suave com amortecedor de ar para portas até 80kg. Curso de 100mm e caixa metálica / Soft close system with air damper for 80kg doors. Stroke of 100mm and metallic case / Sistema de cierre suave con amortiguador de aire para puertas hasta 80kg. Carrera de 100mm y caja metálica.**

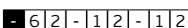

EN1527 

(A) FIXO À PAREDE /
FIXED AT WALL / FIJADO A LA PARED.

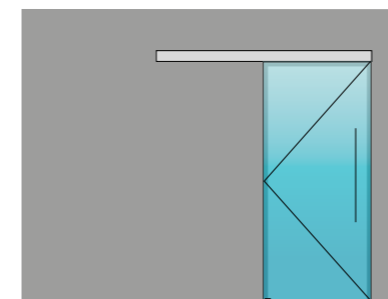

IN.15.740.S.2000
IN.15.740.S.3000
IN.15.740.S.4000
Sistema de porta de correr /
Sliding door system /
Sistema de puerta corredera.
(2000 / 3000 / 4000mm)

(B) FIXO NO TETO /
FIXED ON THE CEILING / FIJADO EN EL TECHO.

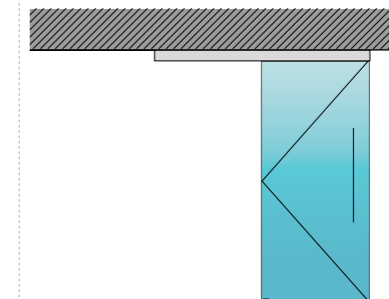

IN.15.740.S.2000
IN.15.740.S.3000
IN.15.740.S.4000
Sistema de porta de correr /
Sliding door system /
Sistema de puerta corredera.
(2000 / 3000 / 4000mm)

(C) FIXO AO TETO COM PAINEL DE VIDRO /
FIXED TO THE CEILING WITH GLASS PANEL /
FIJACIÓN AL TECHO CON PANEL DE CRISTAL.

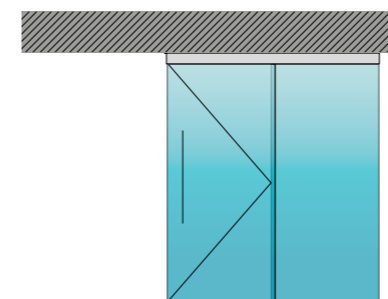

IN.15.740.S.2000
IN.15.740.S.3000
IN.15.740.S.4000
Sistema de porta de correr /
Sliding door system /
Sistema de puerta corredera.
(2000 / 3000 / 4000mm)

IN.15.427.1500
Carril para suspensão no vidro fixo
/ Track for suspension on fixed glass /
Carril para sujetar al cristal fijo.

MECANO SINCRO DOUBLE DOORS

SISTEMAS MANUAIS PARA PORTAS DE CORRER / MANUAL SLIDING DOOR SYSTEMS / SISTEMAS MANUALES PARA PUERTAS CORREDERAS.

MECANO SINCRO DOUBLE DOORS

NO SISTEMA DE PORTA DUPLA SINCRONIZADA AS PORTAS ABREM E FECHAM SIMULTANEAMENTE SENDO OPERADAS MANUALMENTE. UM CABO DE AÇO ENCARREGA-SE DA TRANSMISSÃO DE MOVIMENTOS.

IN THE SYNCHRONIZED DOUBLE DOOR SYSTEM THE DOORS OPEN AND CLOSE SIMULTANEOUSLY BEING MANUALLY OPERATED. A STAINLESS STEEL CABLE IS RESPONSIBLE FOR TRANSMITTING MOVEMENTS.

EN EL SISTEMA DE DOBLE PUERTA SINCRONIZADA LAS PUERTAS SE ABREN Y CIERRAN SIMULTANEAMENTE SIENDO ACCIONADAS MANUALMENTE. UN CABLE DE ACERO ES EL ENCARGADO DE TRANSMITIR LOS MOVIMIENTOS.



FOR DOUBLE GLASS DOORS

ACABAMENTOS DISPONÍVEIS / AVAILABLE FINISHINGS / ACABADOS DISPONIBLES.

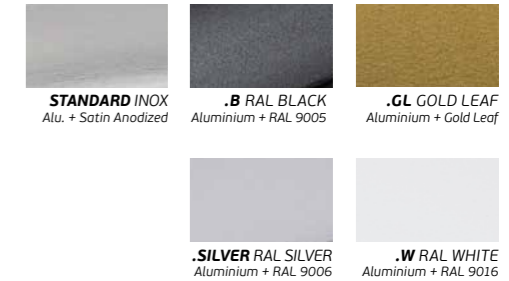

- 1. Carril superior em alumínio anodizado cor inox / Upper track in aluminium anodized color inox / Carril superior en aluminio anodizado color inox. (2000/3000/4000mm)**
- 2. Ajuste de altura +- 6mm / Height adjustment +- 6mm / Ajuste de altura +- 6mm.**
- 3. Bloqueio do ajuste em altura / Height adjustment lock / Bloqueo del ajuste de altura.**
- 4. Carros com dupla roda de "POM" com rolamentos de esferas / "POM" double wheel trucks with ball bearings / Carros con rueda doble "POM" con rodamientos de bolas.**
- 5. Botante em alumínio com borracha para amortecimento. Fácil de instalar, mesmo no final da aplicação / Aluminum stoppers with rubber for cushioning. Easy to install, even at the end of the application / Tapes de aluminio con goma para amortiguación. Fácil de instalar, incluso al final de la aplicación.**
- 6. Vidro laminado ou temperado de 8 a 10mm de espessura com peso máximo de 80kg sem necessidade de entalhes / Laminated or tempered glass from 8 to 10mm thick with a maximum weight of 80kg without the need for cutouts / Cristal laminado o templado de 8 a 10mm de espesor con un peso máximo de 80kg sin necesidad de taladros.**
- 7. Guia de pavimento para vidro com espessura ajustável em aço inoxidável / Floor guide for glass with adjustable thickness in stainless steel / Guía de piso para cristal con espesor ajustable en acero inoxidable.**
- 8. Tampa frontal em alumínio anodizado cor inox / Front cover in aluminium anodized color inox / Tapa frontal en aluminio anodizado color inox. (2000/3000/4000mm)**
- 9. Tampa lateral em aço inoxidável / Side cover in stainless steel / Tapa lateral en acero inoxidable.**
- 10. Sistema de roldanas que sincronizam o movimento de ambas as portas / Pulley system that synchronizes the movement of both doors / Sistema de poleas que sincroniza el movimiento de ambas puertas**
- 11. O cabo de aço é o elemento responsável pela transmissão do movimento / The steel cable is the element responsible for transmitting the movement / El cable de acero es el elemento encargado de transmitir el movimiento.**

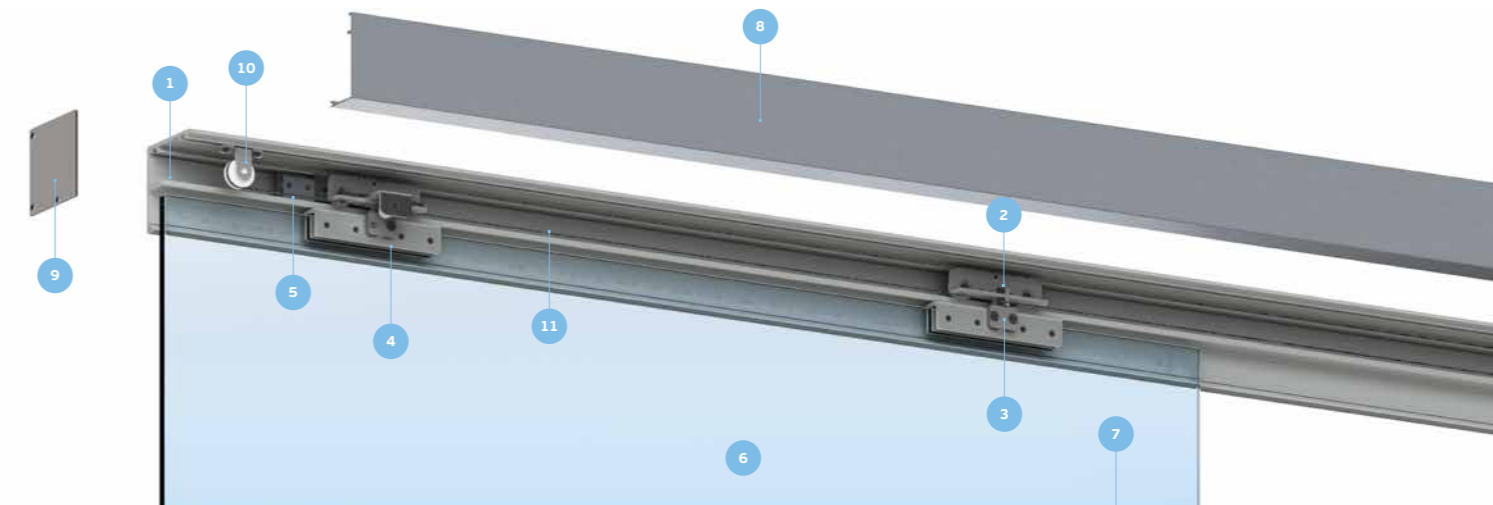

EN1527 - 6 | 2 | - | 1 | 2 | - | 1 | 1

Sistema manual para portas sincronizadas. Pode ser aplicado em portas duplas de vidro ou madeira até um peso máximo de 80kg por porta. Indicado para vãos de grandes dimensões.

Manual system for synchronized doors. It can be applied on double glass or timber doors up to maximum of 80kg per door. Suitable for large spans.

Sistema manual para puertas sincronizadas. Puede ser aplicado en puertas dobles de cristal o madera hasta un peso máximo de 80kg por puerta. Indicado para grandes vanos.

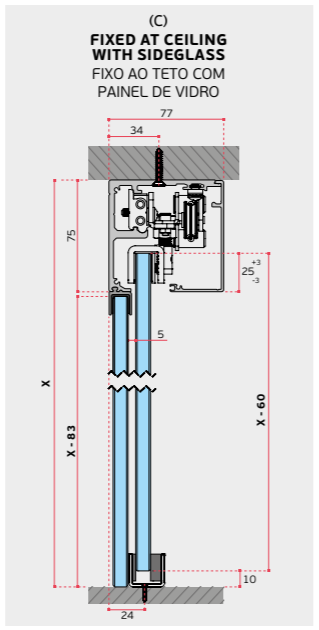
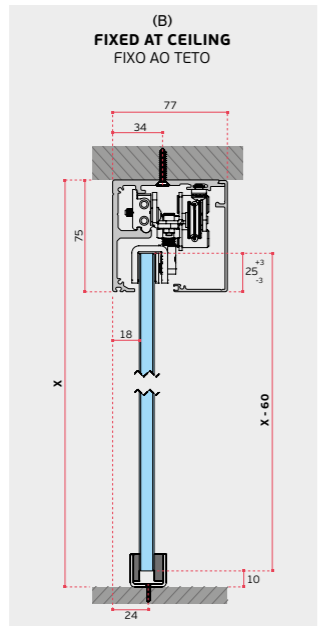
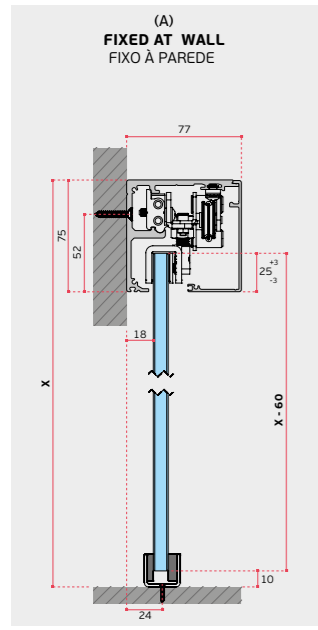

(A) FIXO À PAREDE / FIXED AT WALL / FIJADO A LA PARED.

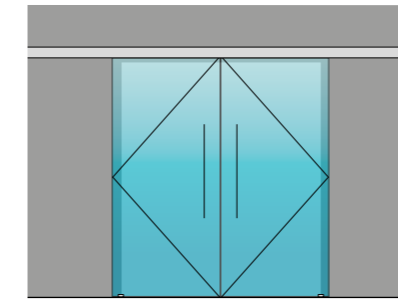

IN.15.741.4000
IN.15.741.6000
Sistema de porta de correr / Sliding door system / Sistema de puerta corredera. (4000 / 6000mm)

(B) FIXO NO TETO / FIXED ON THE CEILING / FIJADO EN EL TECHO.

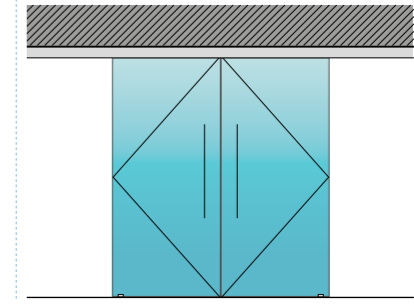

IN.15.741.4000
IN.15.741.6000
Sistema de porta de correr / Sliding door system / Sistema de puerta corredera. (4000 / 6000mm)

(C) FIXO AO TETO COM PAINEL DE VIDRO / FIXED TO THE CEILING WITH GLASS PANEL / FIJACIÓN AL TECHO CON PANEL DE CRISTAL.

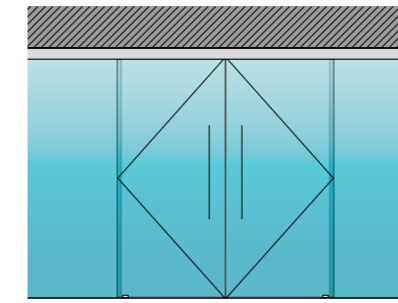

IN.15.741.4000
IN.15.741.6000
Sistema de porta de correr / Sliding door system / Sistema de puerta corredera. (4000 / 6000mm)

IN.15.707.4000
IN.15.707.6000
Carril para suspensão no vidro fixo / Track for suspension on fixed glass / Carril para sujetar al cristal fijo.

SISTEMA PARA PORTAS DE CORRER - Ø25mm

SLIDING DOORS SYSTEM - Ø25mm

SISTEMA PARA PUERTAS CORREDERAS - Ø25mm

SISTEMAS TRADICIONAIS ORIGINAM NOVAS INSPIRAÇÕES!

A busca de sistemas antigos para portas de correr inspiraram estas novas linhas de roldanas re-estilizadas. Criaram-se soluções que assumem a forma mecânica original mas com peças de elevada sofisticação. Os materiais utilizados são o aço escovado ou polido e o alumínio mecanizados com centros de controlo numérico obtendo-se peças com formas perfeitas e funcionamento preciso.

TRADITIONAL SYSTEMS CREATE NEW INSPIRATIONS!

The research for old systems for sliding doors inspired these new lines of re-stylized hardware. The new solutions takes the original form with evident mechanical parts, but with high sophistication.

The used materials are the stainless steel or aluminium brushed or polished finish mechanized with CNC centers, resulting parts with perfect shape and precise function.

LOS SISTEMAS TRADICIONALES PRODUCEN NUEVAS INSPIRACIONES!

La búsqueda de sistemas antiguos para puertas correderas ha inspirado la creación de estas nuevas líneas re-estilizadas de herrajes.

Fueran desarrolladas soluciones que adaptan la forma original pero con piezas mecánicas asumidas de alta sofisticación. Los materiales utilizados son el acero inoxidable y el aluminio cepillado o pulido mecanizado con centros de control numérico, lo que resulta en piezas con formas perfectas y precisas en el funcionamiento.

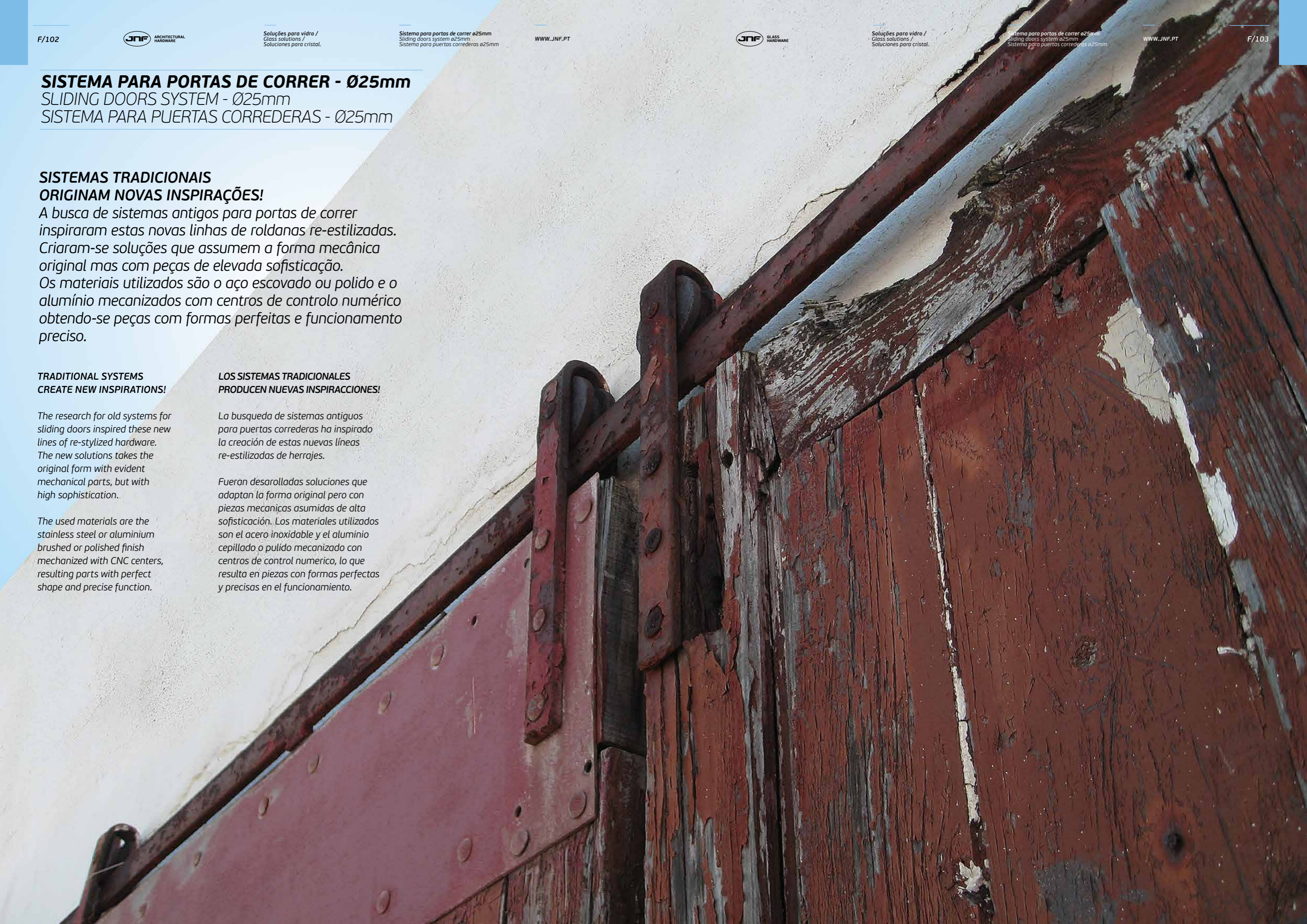

GRAVITY SYSTEM

SISTEMA MECÂNICO DE PORTA DE CORRER AUTOMÁTICO/
AUTOMATIC SLIDING DOOR MECHANICAL SYSTEM /
SISTEMA MECANICO DE PUERTA CORREDERA AUTOMATICA

GRAVITY SYSTEM FOR GLASS

O fascínio de um sistema mecânico que funciona por gravidade! Aqui tudo é aparente, funcionando sem segredos, um cabo de aço encarrega-se da transmissão de movimentos, mas associa um pêndulo que se encarrega do fecho automático da porta. O movimento de abertura da porta origina a elevação dum peso. Todo o processo envolve a subida dum pêndulo e a sua posterior descida arrastando a porta e criando uma harmonia mecânica de movimentos que é impossível não impressionar o observador! Verdadeiramente um sistema intemporal e perpétuo. A porta abre operada manualmente e fecha por gravidade.

The fascination of a mechanical system that works by gravity! Here everything is running without apparent secrets, a steel cable is responsible for the transmission of movements, but combines a pendulum that is in charge of the automatic closing of the door. The whole process involves the rise of a pendulum and its subsequent fall dragging the door and creating a line of mechanical movements that it is impossible not to impress the observer! Truly a timeless and eternal system. The door opens and closes manually operated by gravity.

La fascinación de un sistema mecánico que funciona por gravedad! Aquí todo está funcionando sin aparente secretos, un cable de acero es el responsable de la transmisión de movimientos, pero combina un péndulo que es encargado del cierre automático de la puerta. Todo el proceso implica la subida de un péndulo y su posterior descenso arrastrando la puerta y la creación de una serie de movimientos mecánicos que es imposible no impresionar al observador! Verdaderamente un sistema atemporal y perpetuo. La puerta se abre y se cierra manualmente operado por la gravedad.

GRAVITY SYSTEM

SISTEMA MECÂNICO DE PORTA DE CORRER AUTOMÁTICO/
AUTOMATIC SLIDING DOOR MECHANICAL SYSTEM /
SISTEMA MECANICO DE PUERTA CORREDERA AUTOMATICA

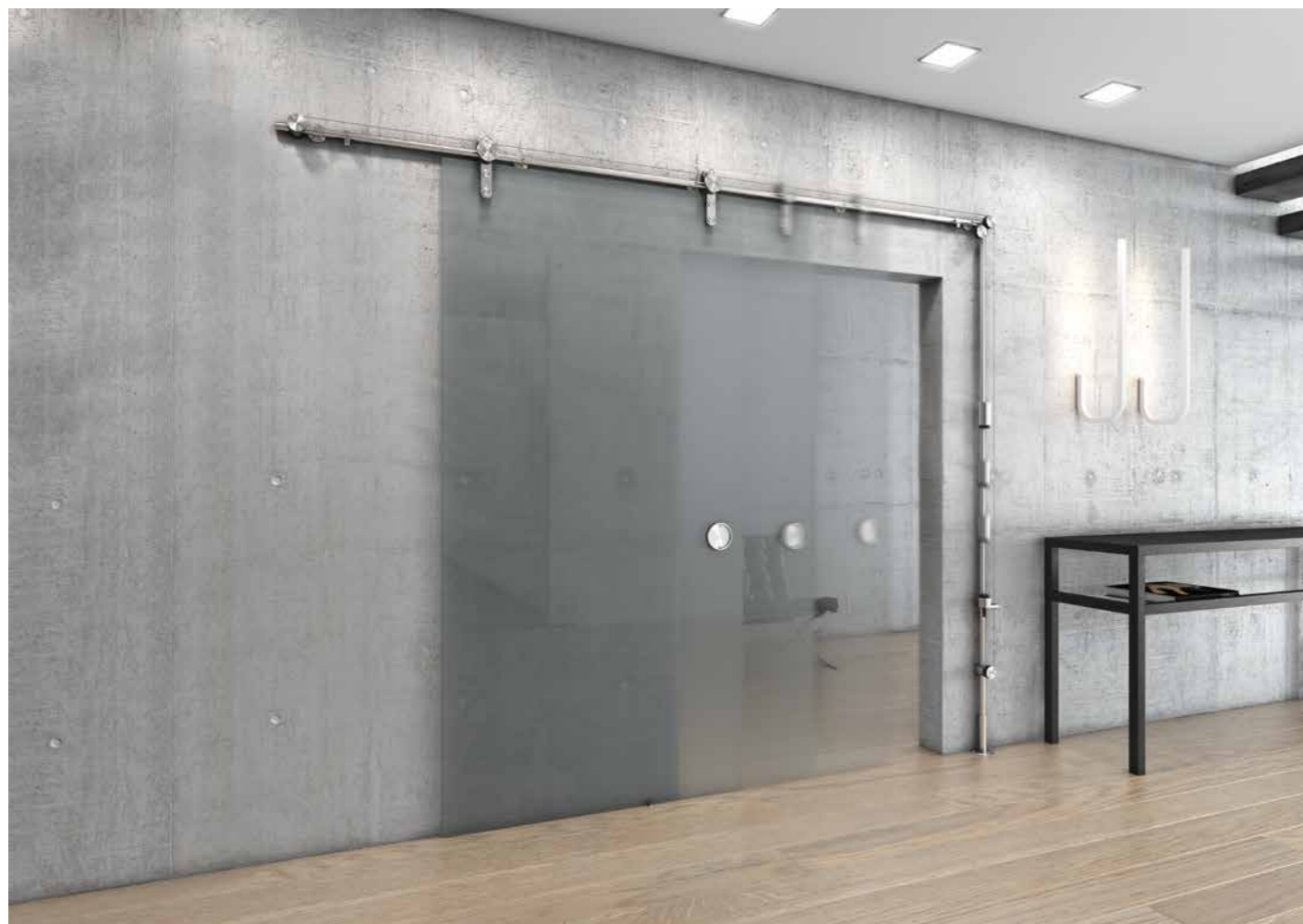

Tensionador
do cabo de aço /
Wire rope tensioner /
Tensionador de cable
de acero.

Pêndulo com amortecedor.
Possibilidade de aumentar
o peso para ajustar a
velocidade de fecho e
compensação do peso da
porta. /

Damped pendulum. Possibility
of increasing weight to adjust
closing speed and compensate
the weight of the door /

Pêndulo amortiguador.
Possibilidade de aumentar el peso
para ajustar la velocidad de
cierre y compensar el peso de
la puerta.

Pé ajustável /
Adjustable feet /
Pie ajustable.

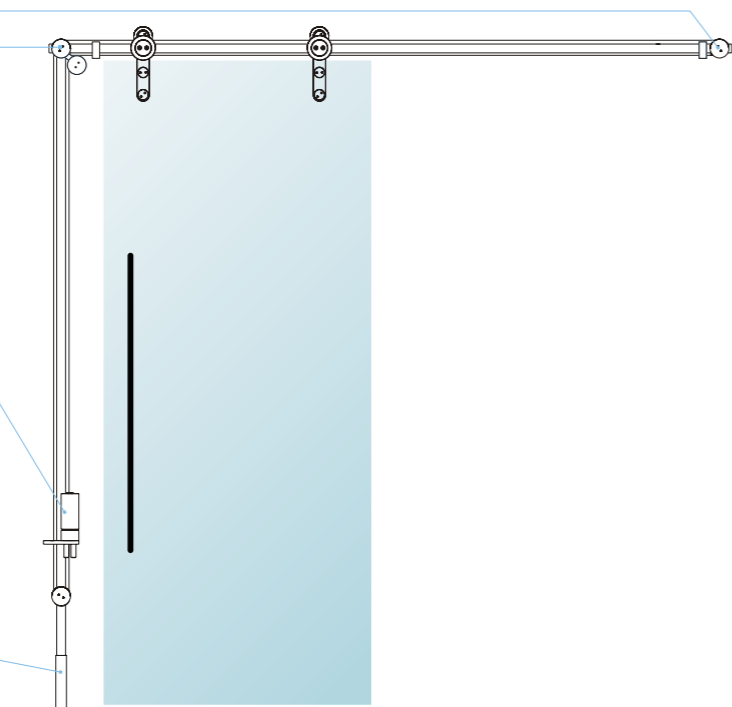

O fascínio de um sistema mecânico que funciona por gravidade! Aqui tudo é aparente, funcionando sem segredos, um cabo de aço encarrega-se da transmissão de movimentos, mas associa um pêndulo que se encarrega do fecho automático da porta.

O movimento de abertura da porta origina a elevação dum peso. Ao soltar a porta, esta inicia um movimento de fecho suave com amortecimento final.

Todo o processo envolve a subida dum pêndulo e a sua posterior descida arrastando a porta e criando uma harmonia mecânica de movimentos que é impossível não impressionar o observador!

Verdadeiramente um sistema intemporal e perpétuo. A porta abre operada manualmente e fecha por gravidade.

The fascination of a mechanical system that works by gravity! Here everything is running without apparent secrets, a steel cable is responsible for the transmission of movements, but combines a pendulum that is in charge of the automatic closing of the door.

The movement of the door opening produce the lifting of an weight. Releasing the door, it starts a movement of closing with a soft final damp.

The whole process involves the rise of a pendulum and its subsequent fall dragging the door and creating a line of mechanical movements that it is impossible not impress the observer!

Truly a timeless and eternal system. The door opens and closes manually operated by gravity.

La fascinacion de un sistema mecanico que funciona por gravedad! Aqui todo está funcionando sin aparente secretos, un cable de acero es el responsable de la transmision de movimientos, pero combina un pendulo que es encargado del cierre automatico de la puerta.

El movimiento de la abertura de la puerta produce la elevación de un peso. Para liberar la puerta, comienza un movimiento de cierre con un final suave amortiguado.

Todo el proceso implica la subida de un pendulo y su posterior descenso arrastrando la puerta y la creación de una serie de movimientos mecanicos que es imposible no impresionar al observador!

Verdaderamente un sistema atemporal y perpetuo. La puerta se abre y se cierra manualmente operado por la gravedad.

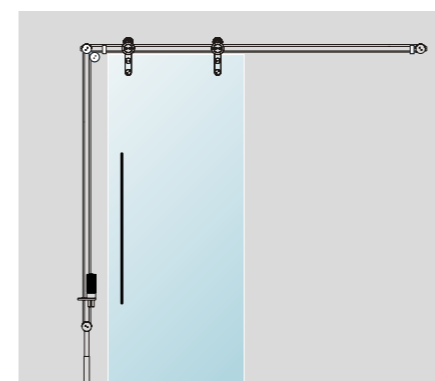

STAGE 1
Porta fechada /
Closed door /
Puerta cerrada.

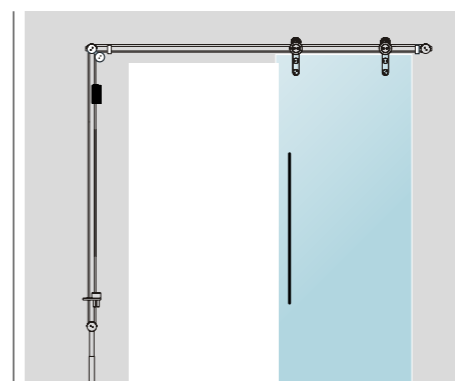

STAGE 2
Porta aberta, o contrapeso sobe /
Door open, counterweight goes up /
Puerta abierta, contrapeso sube.

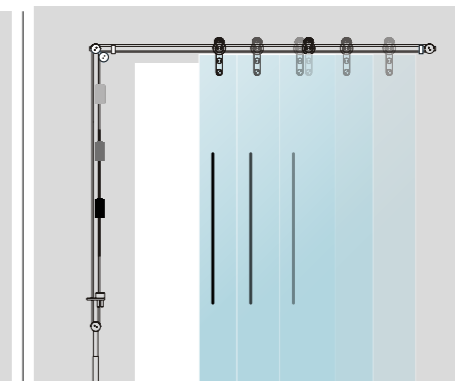

STAGE 3
A porta fecha automaticamente usando a gravidade. O contrapeso ao chegar ao fim de curso é amortecido /
The door closes automatically using gravity. The counterweight upon reaching the end of the course is damped / La puerta se cierra automaticamente por gravedad. El contrapeso al llegar al final del recorrido se amortigua.

GRAVITY SYSTEM

SISTEMA MECÂNICO DE PORTA DE CORRER AUTOMÁTICO / AUTOMATIC SLIDING DOOR MECHANICAL SYSTEM / SISTEMA MECANICO DE PUERTA CORREDERA AUTOMATICA

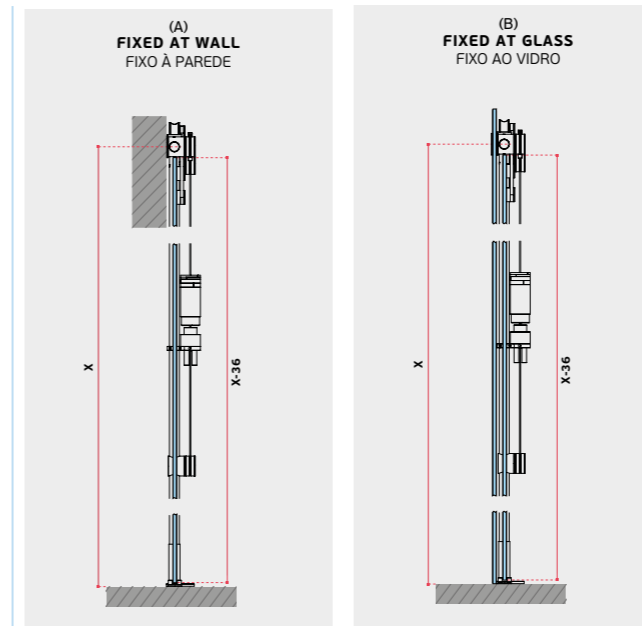

(A) FIXO À PAREDE / FIXED AT WALL / FIJADO A PARED

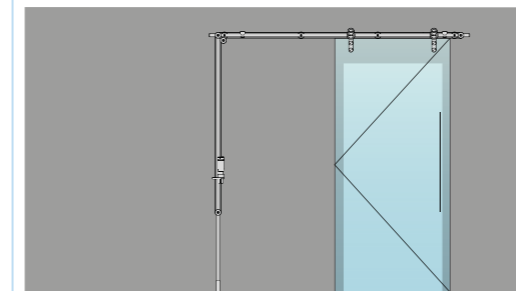

1x IN.15.302/ Conjunto completo para porta de vidro / Complete set for glass sliding door / Conjunto completo para puertas correderas

(B) FIXO NO VIDRO / FIXED AT GLASS / FIJA EN CRISTAL

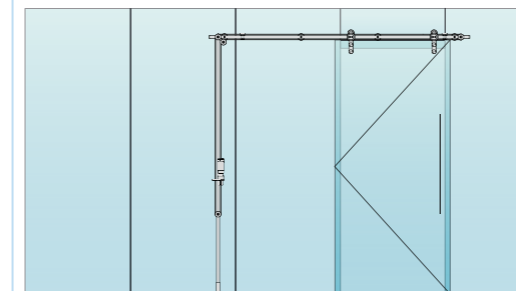

1x IN.15.302/ Conjunto completo para porta de vidro / Complete set for glass sliding door / Conjunto completo para puertas correderas / 4x IN.15.017 / Fixadores para vidro / glass fixings / fijadores para cristal



GRAVITY System for glass.

IN.15.302

Material: EN 1.4301
Conjunto completo para porta de vidro com largura de 800 a 1000mm.
Peso máx. de porta 120Kg
Espessura da porta de vidro: 8 - 12 mm (porta não incluída)

Material: EN 1.4401
Complete set for glass sliding door with 800 to 1000mm wide / Max. load door 120 Kg
Glass Thickness: 8 - 12mm (door not included)

Material: EN 1.4301
Conjunto completo para puertas correderas con 800 hasta 1000mm de ancho.
Peso máx. de puerta 120Kg
Espesor de la puerta de cristal: 8 - 12 mm (puerta no incluida)

VIDRO / GLASS / CRISTAL	X
8mm	18mm
10mm	16mm
12mm	14mm

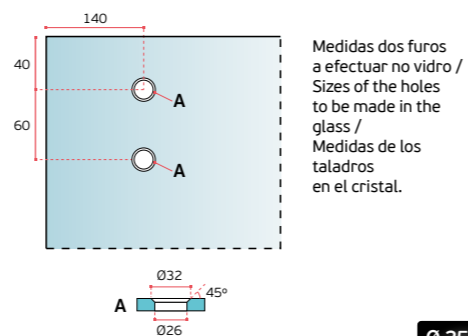
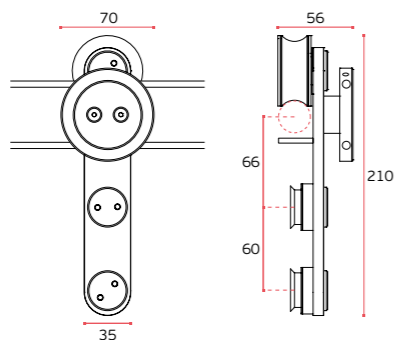

Medidas dos furos a efectuar no vidro / Sizes of the holes to be made in the glass / Medidas de los taladros en el cristal.

Ø 25mm

SISTEMA MODULAR - PORTAS DE CORRER - Ø25mm

MODULAR SYSTEM - SLIDING DOORS - Ø25mm

SISTEMA MODULAR - PUERTAS CORREDERAS - Ø25mm

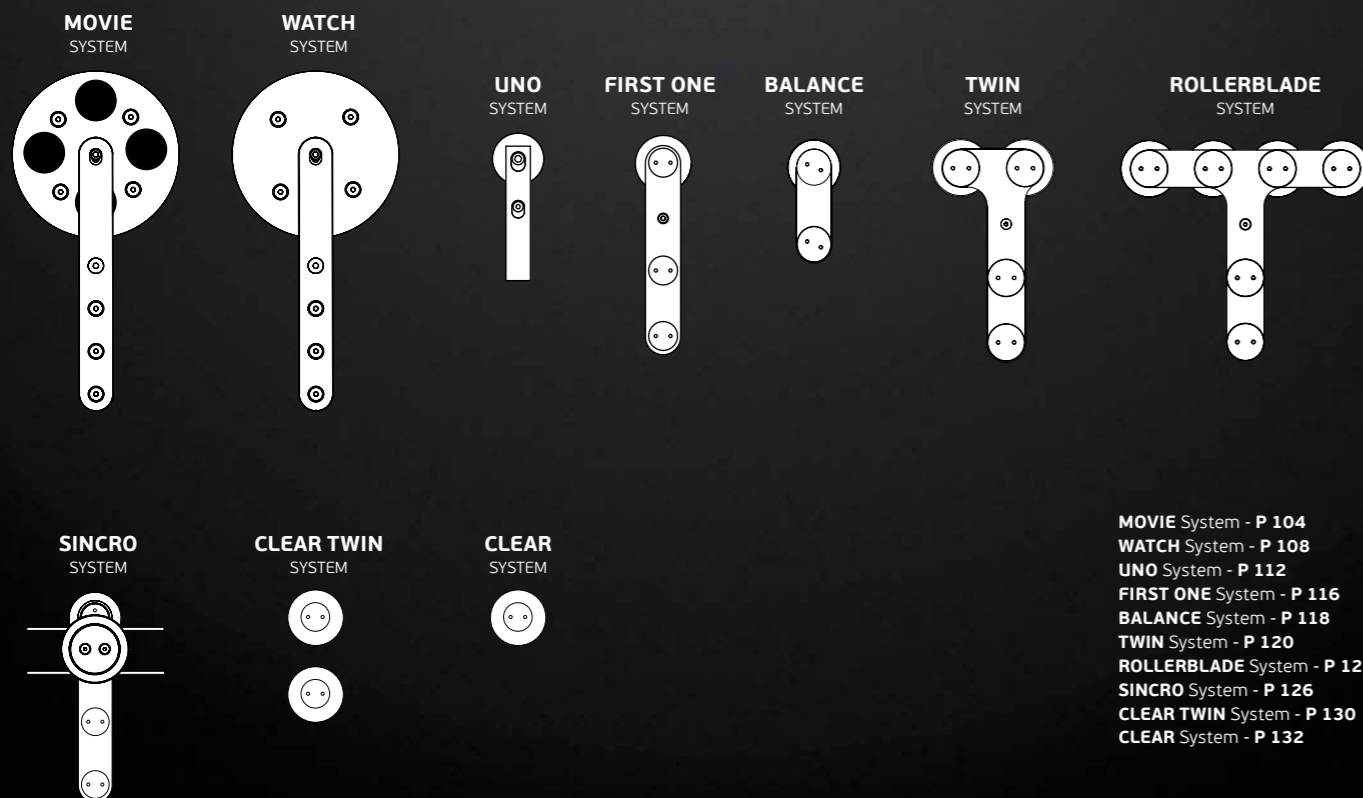
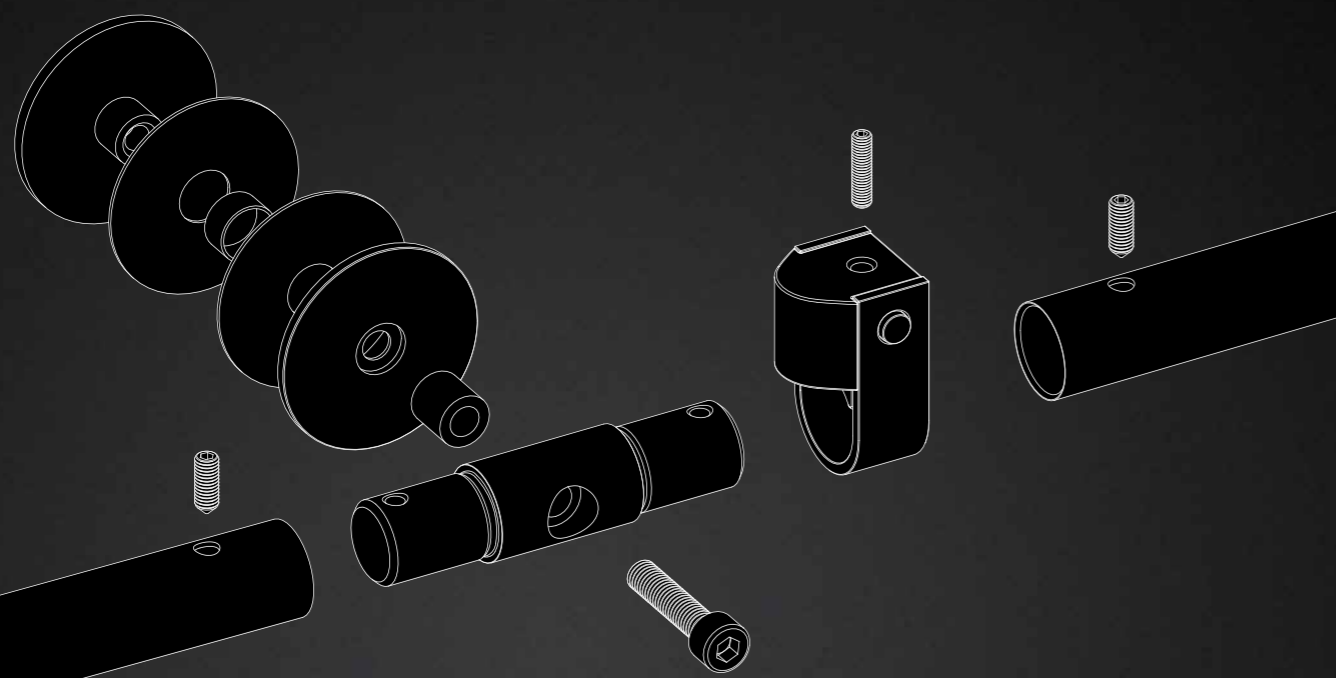

MOVIE System - P 104
WATCH System - P 108
UNO System - P 112
FIRST ONE System - P 116
BALANCE System - P 118
TWIN System - P 120
ROLLERBLADE System - P 122
SINCRÓ System - P 126
CLEAR TWIN System - P 130
CLEAR System - P 132

ESTE INOVADOR SISTEMA PARA PORTAS DE CORRER PERMITE UMA MODULARIDADE DE INSTALAÇÃO SEM LIMITES.

É possível criar portas de correr com as ferragens visíveis em quase todas as situações, isto graças à existência dum vasto leque de fixações, tais como suporte à parede, nos topos, ao tecto, duplo, e ainda a combinação de todas estas alternativas.

O sistema pode ser aplicado em espaços sem que estes tenham sido pensados especificamente para receber uma porta de correr, ou seja, pode ser aplicado sem que seja necessário criar novas estruturas ou mesmo alterar as existentes.

O carril para os rodízios é tubular de diâmetro 25mm e pode assumir qualquer dimensão, acrescentando tubos e uniões, o limite para a estrutura torna-se inexistente. Mesmo com os tubos fornecidos com medidas fixas, é possível criar o sistema com uma medida específica, pois os tubos podem ser cortados no local e da mesma forma fixos às uniões.

Estes tubos tem diâmetro 25mm. e uma parede de 2mm, o que lhes confere uma grande resistência e capacidade de sustentar portas até 120 Kg. Para que o sistema seja o mais silencioso e suave todos os tubos e uniões são rectificadas, desta forma os rodízios movimentam-se nas juntas sem qualquer vibração ou ruído. Existe a possibilidade de fixar o sistema a uma parede de vidro, dando uma grande liberdade de aplicações, desde espaços públicos, a compartimentação de escritórios, uso em habitações, casas de banho, servindo de resguardo de banheira, etc.

A JNF disponibiliza dois sistemas de rodízios, um para portas de vidro e um outro para portas de madeira, alumínio ou metálicas. Ambos os sistemas possuem rolamentos e um revestimento de nylon, que em sincronia com o tubo e uniões conferem um deslizar perfeito, silencioso e preciso. Todos os componentes metálicos são produzidos em aço inox, o que permite a sua instalação em qualquer espaço interior ou exterior.

THIS INNOVATIVE SYSTEM FOR SLIDING DOORS ALLOWS A MODULARITY OF INSTALLATION WITHOUT LIMITS.

It is possible to create sliding doors with the visible hardware in almost all the situations, this is possible thanks to the existence of a vast range of fittings, such as support to the wall, in the terminals, at the ceiling, double track, and also the combination of all these alternatives.

This system can be applied in any spaces even if these have been created don't thinking specifically to receive a sliding door, or either that it is not necessary to create new structures or even to modify the existing ones.

The railing for the casters is made by tube with diameter 25mm and can assume any dimension, adding tubes and connectors, the limit for the structure becomes in-existent.

Even with the supplied tubes with fixed measures, it is possible to create the system with a specific size, therefore the tubes can be cutted in the place and in the same way fixed to the connectors.

These tubes have diameter 25mm. and a wall thickness of 2 mm giving great resistance and capacity to the system allowing to hold doors up to 120 Kg. In order to warranty a very smooth, silent and precise running of the doors, all the tubes and connections are rectified, allowing that when passing the casters in the meeting points do not create any vibration or noise. It's possible to fix the system to a glass wall, giving a great freedom of applications, since public spaces, the creation of privacy areas in offices, to be used at private homes, bathrooms, shower cabinets, etc.

JNF provides two systems of casters, one for glass doors and one for wooden, aluminium or metallic doors. Both the systems It's provided with ball bearings and an nylon wheels, that together with the tube and connectors confers a perfect sliding function. All the metallic components are produced in stainless steel, that allows its installation in any interior or exterior areas.

ESTE SISTEMA INNOVADOR PARA PUERTAS CORREDERAS PERMITE UNA MODULACIÓN DE LA INSTALACIÓN SIN LIMITES.

Es posible crear puertas correderas con herraje visible en casi todas las situaciones, esta posibilidad se debe gracias a la existencia de una gama extensa de sujeciones, directo a pared, o laterales, en el techo, doble hoja, y tambien la combinación de todas estas alternativas.

Este sistema se puede aplicar en cualquier espacio incluso en los que no han sido creados para recibir una puerta corredera, no es necesario crear nuevas estructuras o modificar las existentes.

La guia corredera es hecha en tubo con el diametro 25 mm y puede asumir cualquier ancho, agregando los tubos y los Conectores el limite para la estructura es inexistente.

Mientras los tubos sean suministrados con medidas fijas, es posible crear el sistema con un tamaño distinto, para eso basta en obra, cortar y conectar los tubos por intermedio de los conectores.

Las guias tubulares son de diametro 25mm y un espesor de pared de 2mm que garantizan gran resistencia y capacidad al sistema permitiendo colgar puertas hasta 120 Kg.

El funcionamiento es suave, silencioso y exacto gracias a todos los tubos y las conexiones haber sido rectificadas permitiendo a las ruedas pasar los conectores en los puntos de la reunion sin ninguna vibracion o ruido.

Es posible fijar el sistema a una pared de cristal, dando una gran libertad de usos, desde espacios públicos, la creacion de areas de aislamiento en oficinas, viviendas, mamparas de ducha, etc.

JNF dispone de dos sistemas de ruedas, uno para puertas de cristal y uno para puertas de madera, aluminio o metálicas. Ambos los sistemas son equipados con rodamientos de bolas y una cubierta de nylon. Todos los componentes metálicos se producen en acero inoxidable, permite su instalacion en cualquier area interior o exterior.

MOVIE SYSTEM

SISTEMA MODULAR - PORTAS DE CORRER - Ø25mm
MODULAR SYSTEM - SLIDING DOORS - Ø25mm
SISTEMA MODULAR - PUERTAS CORREDERAS - Ø25mm

MOVIE SYSTEM FOR GLASS

*Uma roda impressionante pelo desenho, pelo tamanho e pela coreografia do movimento!
Uma roda com um funcionamento extremamente suave e com possibilidade de regulação da altura da porta de forma a efectuar os ajustes mais delicados.*

*An impressive wheel in design, size and movement choreography!
A wheel with an extremely smooth operation and with the possibility of adjusting the height of the door in order to make the most refined adjustments.*

*Una rueda impresionante pelo diseño por el tamaño y la coreografía del movimiento!
Una rueda con un funcionamiento extremadamente suave y con la posibilidad de ajustar la altura de la puerta de forma refinada.*

MOVIE SYSTEM

SISTEMA MODULAR - PORTAS DE CORRER - Ø25mm
 MODULAR SYSTEM - SLIDING DOORS - Ø25mm
 SISTEMA MODULAR - PUERTAS CORREDERAS - Ø25mm

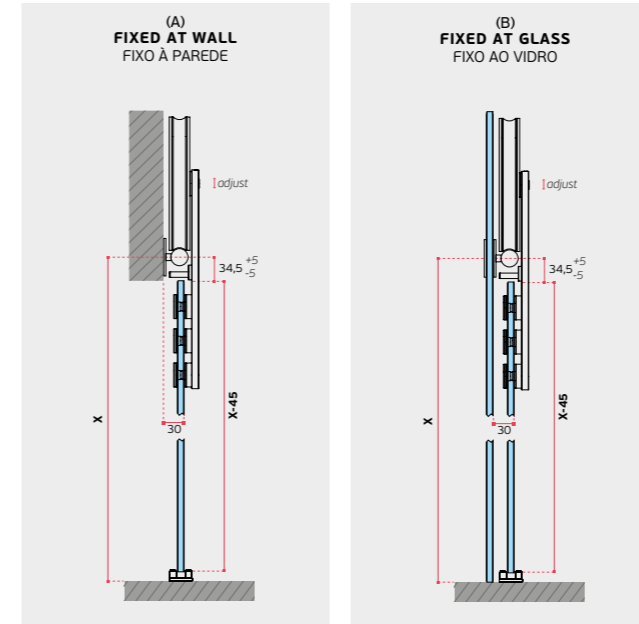

MOVIE System for glass.

IN.15.203

Material: EN 1.4301
 2x Roldanas
 2x Batentes
 1x Guia de pavimento
 Peso máx de porta 200Kg
 Espessura do vidro 8 - 12mm

Material: EN 1.4301
 2x wheels / ruedas
 2x stoppers / frenos
 1x floor guide / guía de suelo
 Max. load / peso max. 200Kg
 Glass thickness / Espesor del cristal : 8 - 12mm

200 kg, 8-12 mm, EN 1.4301, Ø25 mm, MODULAR

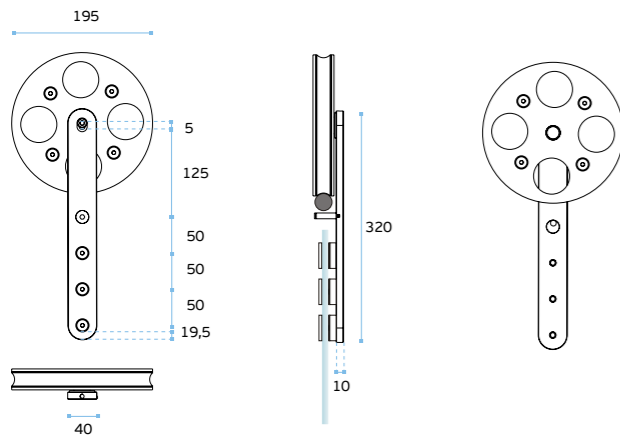
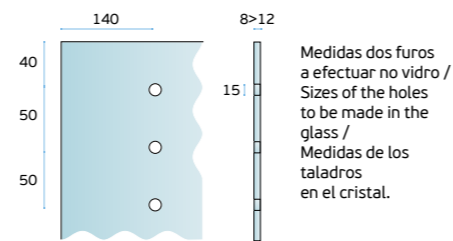
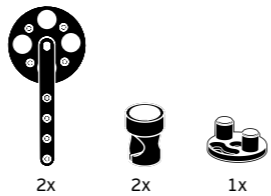

(A) FIXO À PAREDE / FIXED AT WALL / FIJADO A PARED CARRIL / RAIL 1900mm

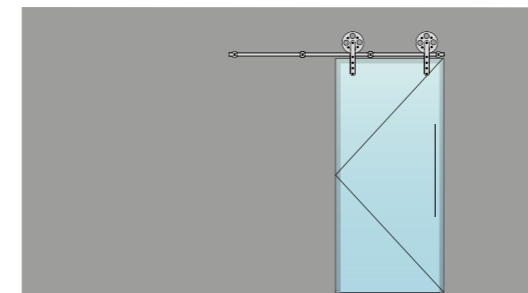

1x IN.15.203 / Roldanas / Wheels / Ruedas
 2x IN.15.012* / Conectores terminais / Terminal connectors / Conectores terminales
 2x IN.15.011* / Conectores / Connectors / Conectores.
 3x IN.15.030* / Tubo standard / Standard tube / Tubo estándar (Ø25 X 560mm)

(A) FIXAÇÃO À PAREDE / FIXED AT WALL / FIJADO A PARED CARRIL / RAIL 3700mm

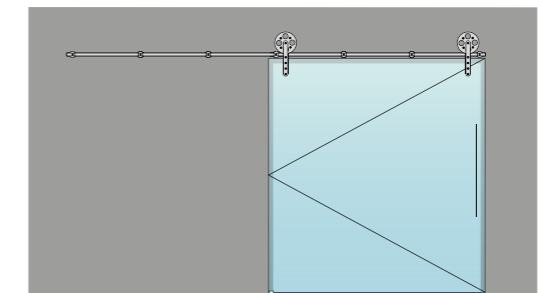

1x IN.15.203 / Roldanas / Wheels / Ruedas
 2x IN.15.012* / Conectores terminais / Terminal connectors / Conectores terminales
 5x IN.15.011* / Conectores / Connectors / Conectores.
 6x IN.15.030* / Tubo standard / Standard tube / Tubo estándar (Ø25 X 560mm)

* Esquema com exemplo de carril com 3700mm, este sistema é modular podendo ser adicionados ou retirados elementos para obter outras dimensões. As referências com * são variáveis segundo as dimensões pretendidas / Diagram with example of rail with 3700 mm, this system is modular and elements can be added or removed to obtain other dimensions. References with * are variable according to the intended dimension /

(B) FIXO AO VIDRO / FIXED AT GLASS / FIJA EN CRISTAL CARRIL / RAIL 1900mm

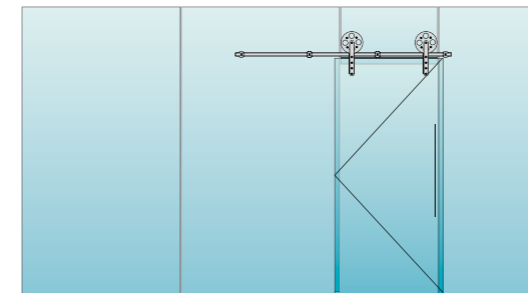

1x IN.15.203 / Roldanas / Wheels / Ruedas
 2x IN.15.012* / Conectores terminais / Terminal connectors / Conectores terminales
 2x IN.15.011* / Conectores / Connectors / Conectores.
 4x IN.15.017* / Fixadores para vidro / Glass fixings / Fijadores para cristal
 3x IN.15.030* / Tubo standard / Standard tube / Tubo estándar (Ø25 X 560mm)

(B) FIXO NO VIDRO / FIXED AT GLASS / FIJA EN CRISTAL CARRIL / RAIL 3700mm

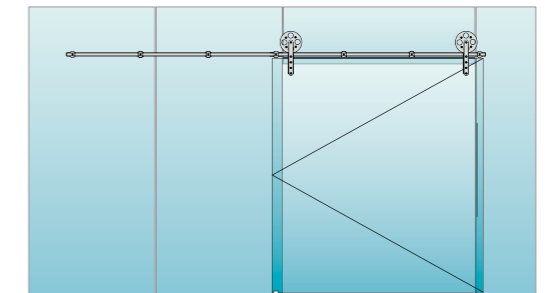

1x IN.15.203 / Roldanas / Wheels / Ruedas
 2x IN.15.012* / Conectores terminais / Terminal connectors / Conectores terminales
 5x IN.15.011* / Conectores / Connectors / Conectores.
 7x IN.15.017* / Fixadores para vidro / Glass fixings / Fijadores para cristal
 6x IN.15.030* / Tubo standard / Standard tube / Tubo estándar (Ø25 X 560mm)

* Esquema com exemplo de carril com 3700 mm, este sistema é modular podendo ser adicionados ou retirados elementos para obter outras dimensões. As referências com * são variáveis segundo as dimensões pretendidas. / Diagram with example of rail with 3700 mm, this system is modular and elements can be added or removed to obtain other dimensions. References with * are variable according to the intended dimension. /

WATCH SYSTEM

SISTEMA MODULAR - PORTAS DE CORRER - Ø25mm
MODULAR SYSTEM - SLIDING DOORS - Ø25mm
SISTEMA MODULAR - PUERTAS CORREDERAS - Ø25mm



WATCH SYSTEM FOR GLASS

*Uma roda com desenho intemporal, que se destaca pelo tamanho e pela suavidade do movimento!
Uma roda com 200mm de diâmetro com possibilidade de regulação da altura da porta de forma a efectuar os ajustes mais delicados. Aplicável em portas de madeira ou vidro até 200Kg.*

*A wheel with timeless design, with highlights on the size and smoothness of movement!
A wheel with the possibility of adjusting the height of the door in order to make the most refined adjustments. Applicable in wood or glass doors of up to 200Kg.*

*Una rueda que se destaca por el diseño, el tamaño y la suavidad de movimiento!
Una rueda con la posibilidad de ajustar la altura de la puerta de forma refinada. Aplicable en puertas de cristal o madera hasta 200Kg.*

WATCH SYSTEM

SISTEMA MODULAR - PORTAS DE CORRER - Ø25mm
 MODULAR SYSTEM - SLIDING DOORS - Ø25mm
 SISTEMA MODULAR - PUERTAS CORREDERAS - Ø25mm

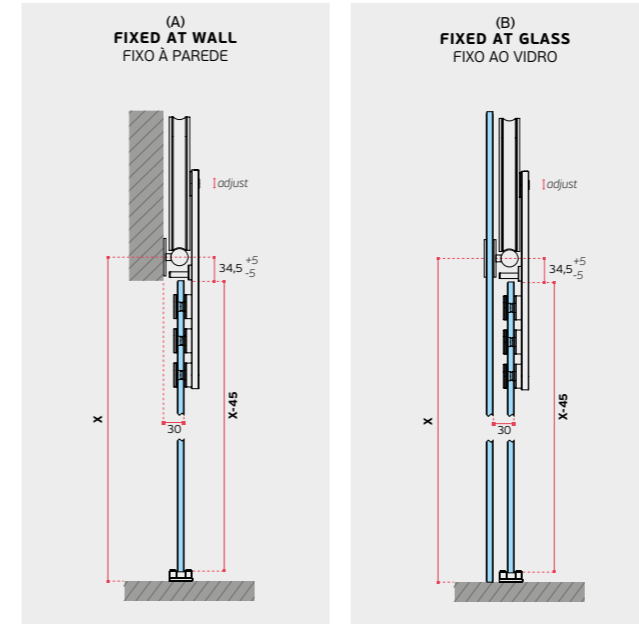

WATCH System for glass.

IN.15.205
 Material: EN 1.4301
 2x Roldanas
 2x Batentes
 1x Guia de pavimento
 Peso máx de porta 200 Kg
 Espessura do vidro 8 - 12 mm

Material: EN 1.4301
 2x wheels / ruedas
 2x stoppers / frenos
 1x floor guide / guia de suelo
 Max. load / peso max. 200 Kg
 Glass Thickness / Espesor del cristal : 8 - 12mm

200 kg, 8-12 mm, EN 1.4301, Ø25 mm, MODULAR

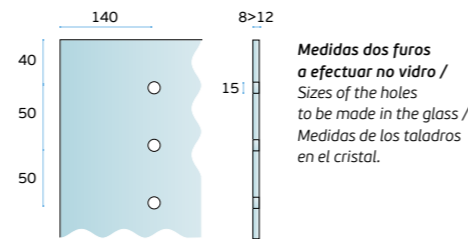
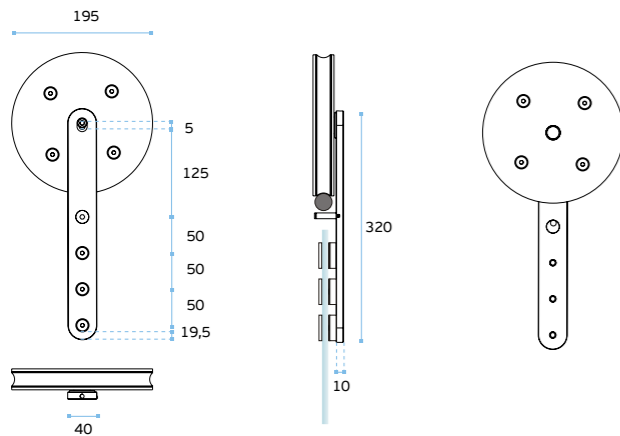
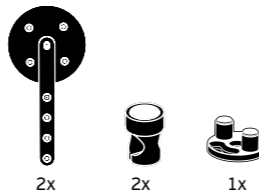

(A) FIXO À PAREDE / FIXED AT WALL / FIJADO A PARED

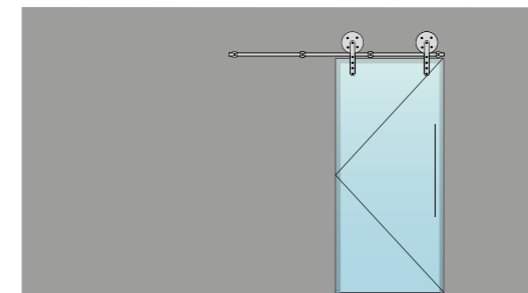

1x IN.15.205 / Roldanas / Wheels / Ruedas
 2x IN.15.012* / Conectores terminais / terminal connectors / conectores terminales
 2x IN.15.011* / Conectores / connectors / conectores.
 3x IN.15.030* / Tubo standard / Standard tube / tubo estándar (Ø25 X 560mm)

(B) FIXED AT GLASS / FIXO NO VIDRO / FIJO EN CRISTAL

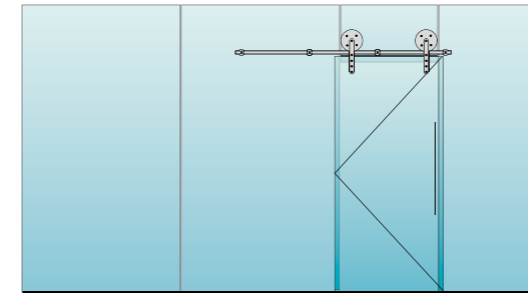

1x IN.15.205 / Roldanas / Wheels / Ruedas
 2x IN.15.012* / Conectores terminais / terminal connectors / conectores terminales
 2x IN.15.011* / Conectores / connectors / conectores.
 4x IN.15.017* / Fixadores para vidro / glass fixings / fijadores para cristal
 3x IN.15.030* / Tubo standard / Standard tube / tubo estándar (Ø25 X 560mm)

(A) FIXAÇÃO À PAREDE / FIXED AT WALL / FIJADO A PARED

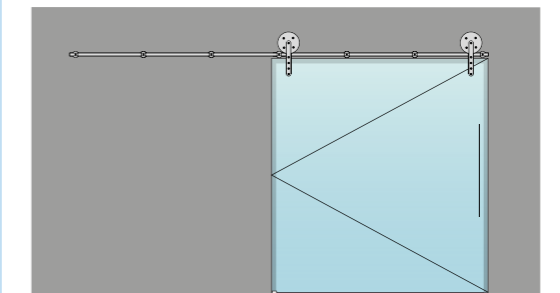

1x IN.15.205 / Roldanas / Wheels / Ruedas
 2x IN.15.012* / Conectores terminais / terminal connectors / conectores terminales
 5x IN.15.011* / Conectores / connectors / conectores.
 6x IN.15.030* / Tubo standard / Standard tube / tubo estándar (Ø25 X 560mm)

(B) FIXO NO VIDRO / FIXED AT GLASS / FIJO EN CRISTAL

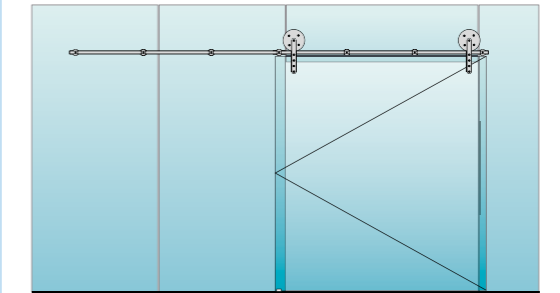

1x IN.15.205 / Roldanas / Wheels / Ruedas
 2x IN.15.012* / Conectores terminais / terminal connectors / conectores terminales
 se pueden añadir o quitar elementos para obtener otras dimensiones. Las referencias con * son variables según la dimensión prevista.
 7x IN.15.017* / Fixadores para vidro / glass fixings / fijadores para cristal
 6x IN.15.030* / Tubo standard / Standard tube / tubo estándar (Ø25 X 560mm)

* Esquema com exemplo de carril com 3700mm, este sistema é modular podendo ser adicionados ou retirados elementos para obter outras dimensões. As referências com * são variáveis segundo as dimensões pretendidas /

Diagram with example of rail with 3700mm, this system is modular and elements can be added or removed to obtain other dimensions. References with * are variable according to the intended dimension. /

Esquema con ejemplo de carril con 3700mm, este sistema es modular y se pueden añadir o quitar elementos para obtener otras dimensiones. Las referencias con * son variables según la dimensión prevista.

* Esquema com exemplo de carril com 3700mm, este sistema é modular podendo ser adicionados ou retirados elementos para obter outras dimensões. As referências com * são variáveis segundo as dimensões pretendidas /

Diagram with example of rail with 3700mm, this system is modular and elements can be added or removed to obtain other dimensions. References with * are variable according to the intended dimension. /

Esquema con ejemplo de carril con 3700 mm, este sistema es modular y se pueden añadir o quitar elementos para obtener otras dimensiones. Las referencias con * son variables según la dimensión prevista.

UNO SYSTEM

SISTEMA MODULAR - PORTAS DE CORRER - 025mm
MODULAR SYSTEM - SLIDING DOORS - 025mm
SISTEMA MODULAR - PUERTAS CORREDEAS - 025mm

UNO SYSTEM FOR GLASS

“Uno” é o desenho mais simples, por isso lhe demos o nome de unidade. Aplicável em portas de vidro ou de madeira.

Pode construir portas de correr para divisórias, sistemas de duche, armários etc. O limite de peso é de 120Kg por porta.

“Uno” is the simplest design and the reason of his name: unity. Applicable in glass or wooden doors. You can build partitions with sliding doors, shower systems, cabinets etc. The maximum weight is 120Kg per door.

“Uno” es el diseño más simples y la razón de su nombre: unidad. Aplicable en puertas de cristal o de madera. Se pueden construir particiones de puertas correderas, sistemas con mamparas de ducha, armarios, etc. El peso máximo es de 120Kg por puerta.

UNO SYSTEM

SISTEMA MODULAR - PORTAS DE CORRER - Ø25mm
 MODULAR SYSTEM - SLIDING DOORS - Ø25mm
 SISTEMA MODULAR - PUERTAS CORREDERAS - Ø25mm



UNO System for glass.

IN.15.210

Material: EN 1.4301
 2x Roldanas
 2x Batentes
 1x Guia de pavimento
 Peso máx de porta 120 Kg
 Espessura de vidro 8 - 12 mm

Material: EN 1.4301
 2x wheels / ruedas
 2x stoppers / frenos
 1x floor guide / guia de suelo
 Max. load / peso max. 120 Kg
 Glass Thickness / Espesor del cristal : 8 - 12mm

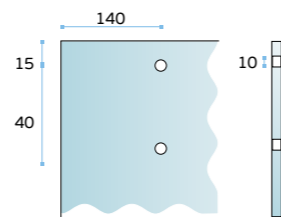
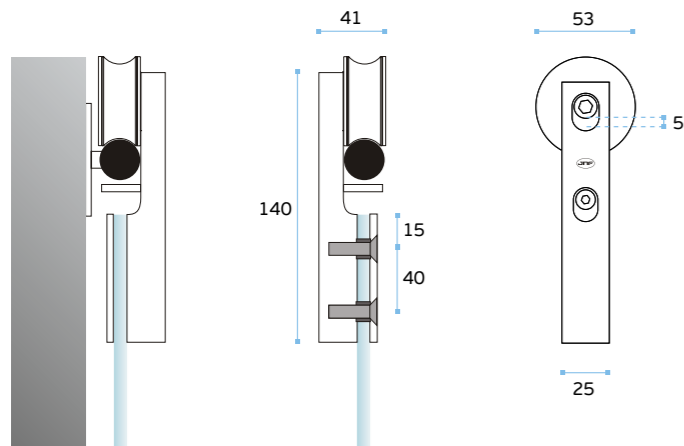
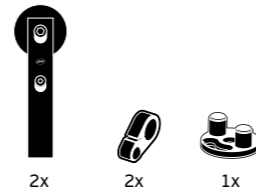

Medidas dos furos a efectuar no vidro / Sizes of the holes to be made in the glass / Medidas de los taladros en el cristal.

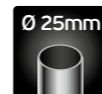

EN1527 - 63 - 14 - 13

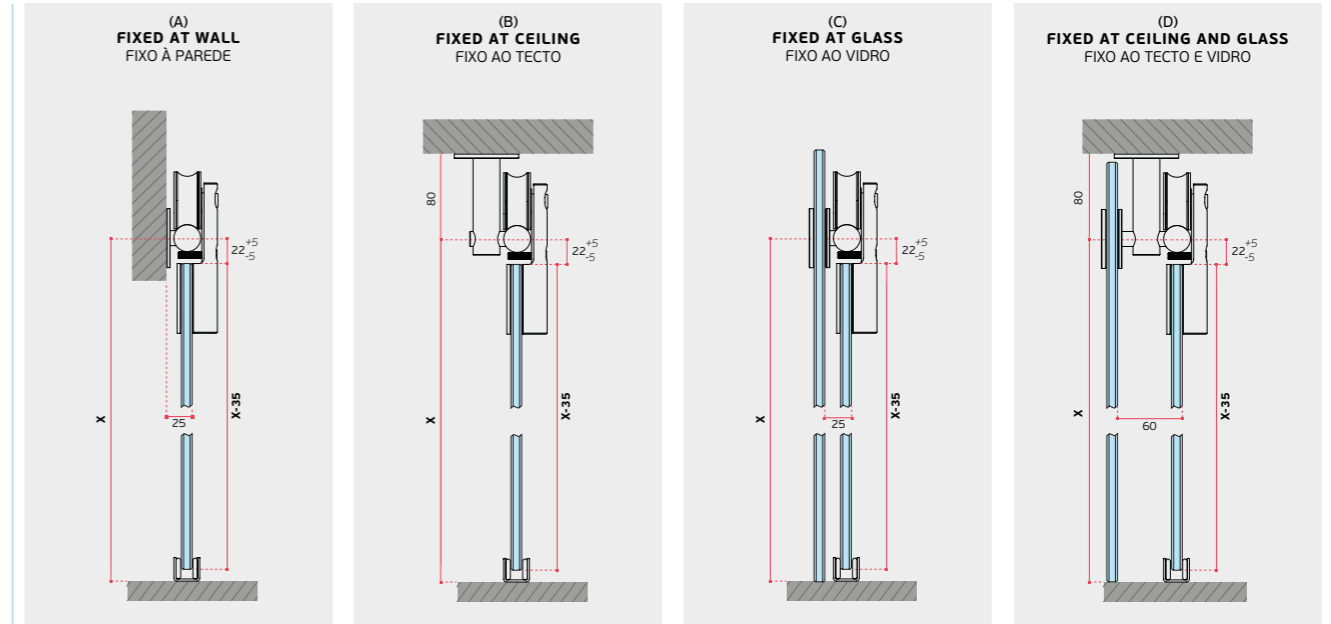

(A) FIXO À PAREDE / FIXED AT WALL / FIJADO A PARED CARRIL / RAIL 1900mm

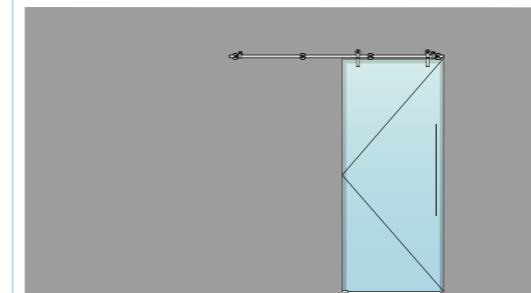

1x IN.15.210 / Roldanas / Wheels / Ruedas
 2x IN.15.012* / Conectores terminais / terminal connectors / conectores terminales
 2x IN.15.011* / Conectores / connectors / conectores.
 3x IN.15.030* / Tubo standard / Standard tube / tubo estándar (Ø25 X 560mm)

(B) FIXAÇÃO AO TECTO / FIXED AT CEILING / FIJO AL TECTO CARRIL / RAIL 1900mm

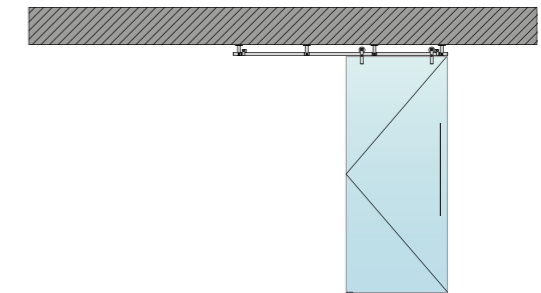

1x IN.15.210 / Roldanas / Wheels / Ruedas
 2x IN.15.043* / Conectores terminais / terminal connectors / conectores terminales
 2x IN.15.042* / Conectores / connectors / conectores.
 3x IN.15.030* / Tubo standard / Standard tube / tubo estándar (Ø25 X 560mm)

* Esquema com exemplo de carril com 3700 mm, este sistema é modular podendo ser adicionados ou retirados elementos para obter outras dimensões. As referências com * são variáveis segundo as dimensões pretendidas. /

Diagram with example of rail with 3700 mm, this system is modular and elements can be added or removed to obtain other dimensions. References with * are variable according to the intended dimension. /

Esquema con ejemplo de carril con 3700 mm, este sistema es modular y se pueden añadir o quitar elementos para obtener otras dimensiones. Las referencias con * son variables según la dimensión prevista.

(C) FIXO NO VIDRO / FIXED AT GLASS / FIJA EN Cristal CARRIL / RAIL 1900mm

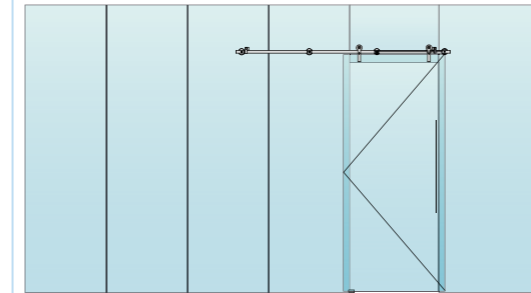

1x IN.15.210 / Roldanas / Wheels / Ruedas
 2x IN.15.012* / Conectores terminais / terminal connectors / conectores terminales
 2x IN.15.011* / Conectores / connectors / conectores.
 4x IN.15.017* / Fixadores para vidro / glass fixings / fijadores para cristal
 3x IN.15.030* / Tubo standard / Standard tube / tubo estándar (Ø25 X 560mm)

(D) FIXAÇÃO AO TECTO E VIDRO / FIXED AT CEILING AND GLASS / FIJO EN TECTO Y Cristal CARRIL / RAIL 1900mm

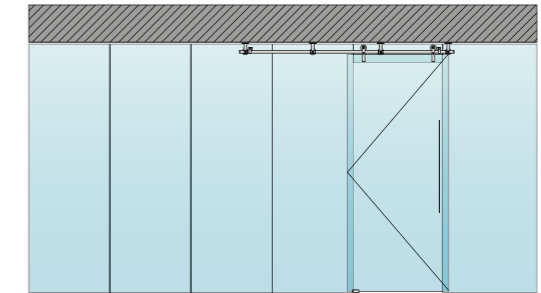

1x IN.15.210 / Roldanas / Wheels / Ruedas
 2x IN.15.047* / Conectores terminais / terminal connectors / conectores terminales
 2x IN.15.046* / Conectores / connectors / conectores.
 3x IN.15.030* / Tubo standard / Standard tube / tubo estándar (Ø25 X 560mm)

* Esquema com exemplo de carril com 3700 mm, este sistema é modular podendo ser adicionados ou retirados elementos para obter outras dimensões. As referências com * são variáveis segundo as dimensões pretendidas. /

Diagram with example of rail with 3700 mm, this system is modular and elements can be added or removed to obtain other dimensions. References with * are variable according to the intended dimension. /

Esquema con ejemplo de carril con 3700 mm, este sistema es modular y se pueden añadir o quitar elementos para obtener otras dimensiones. Las referencias con * son variables según la dimensiones previstas.

FIRST ONE SYSTEM

SISTEMA MODULAR - PORTAS DE CORRER - Ø25mm
MODULAR SYSTEM - SLIDING DOORS - Ø25mm
SISTEMA MODULAR - PUERTAS CORREDERAS - Ø25mm

FIRST ONE SYSTEM FOR GLASS

Sistema de porta de correr com tubo diâmetro 25mm, sistema em aço inoxidável, com rodana em POM reforçado fibra de vidro e duplo rolamento. Permite carga até 120KG por porta.

Sliding door system with 25mm diameter tube, stainless steel system, with fiberglass reinforced POM wheel and double bearing. Allows loads of up to 120KG per door.

Sistema de puerta corredera con tubo de 25mm de diámetro, sistema de acero inoxidable, con rueda de POM reforzada con fibra de cristal y doble rodamiento. Permite cargas hasta 120 KG por puerta.

FIRST ONE SYSTEM

SISTEMA MODULAR - PORTAS DE CORRER - Ø25mm
 MODULAR SYSTEM - SLIDING DOORS - Ø25mm
 SISTEMA MODULAR - PUERTAS CORREDERAS - Ø25mm



FIRST ONE System for glass.

IN.15.002

Material: EN 1.4301
 2x Roldanas
 2x Batentes
 1x Guia de pavimento
 Peso máx de porta 120 Kg
 Espessura de vidro 8 - 12 mm

Material: EN 1.4301
 2x wheels / ruedas
 2x stoppers / frenos
 1x floor guide / guía de suelo
 Max. load / peso max. 120 Kg
 Glass Thickness / Espesor del cristal : 8 - 12mm

120 kg, 8-12 mm, EN 1.4301, Ø25 mm, MODULAR

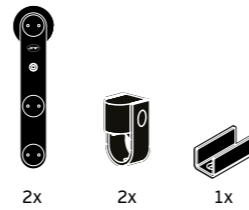

VIDRO / GLASS / CRISTAL	X
8mm	18mm
10mm	16mm
12mm	14mm

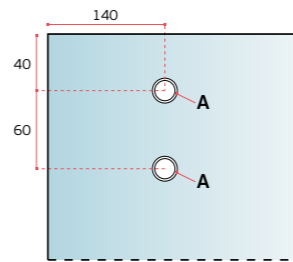
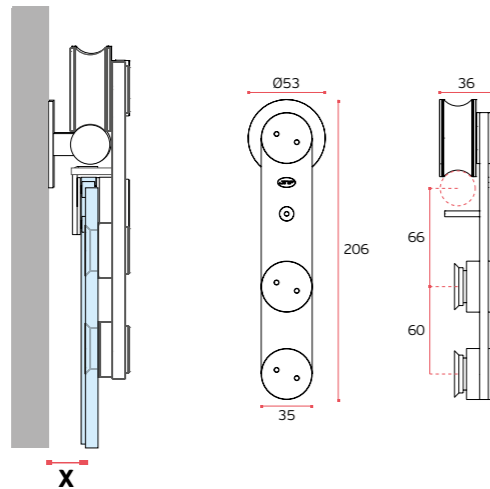

Medidas dos furos a efectuar no vidro / Sizes of the holes to be made in the glass / Medidas de los taladros en el cristal.

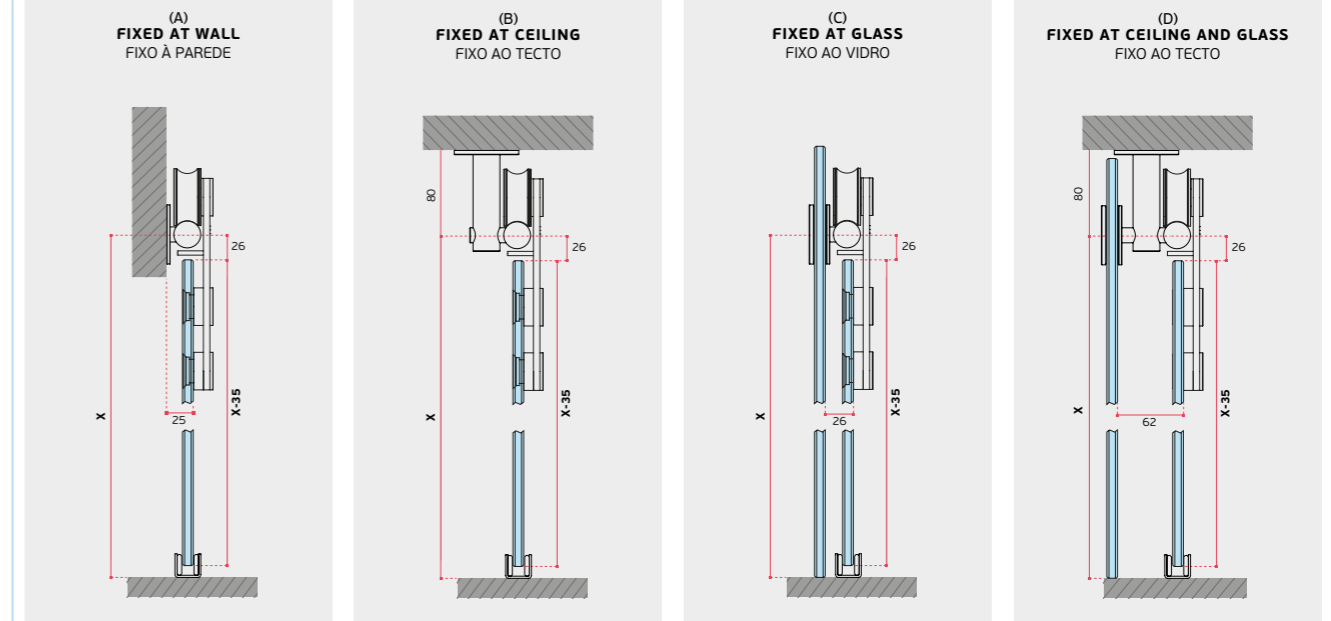

(A) FIXO À PAREDE / FIXED AT WALL / FIJADO A PARED CARRIL / RAIL 1900mm

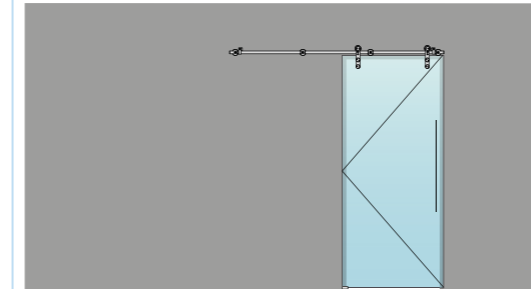

1x IN.15.002 / Roldanas / Wheels / Ruedas
 2x IN.15.012 / Conectores terminais / terminal connectors / conectores terminales
 2x IN.15.011 / Conectores / connectors / conectores.
 3x IN.15.030 / Tubo standard / Standard tube / tubo estándar (Ø25 X 560mm)

(B) FIXAÇÃO AO TECTO / FIXED AT CEILING / FIJO AL TECHO CARRIL / RAIL 1900mm

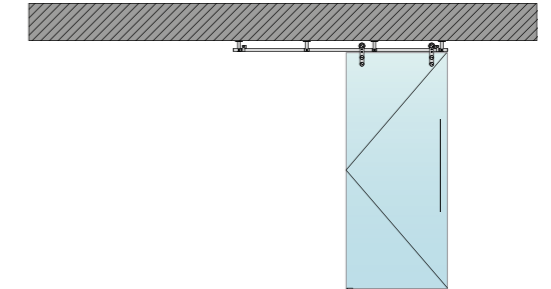

1x IN.15.002 / Roldanas / Wheels / Ruedas
 2x IN.15.043 / Conectores terminais / terminal connectors / conectores terminales
 2x IN.15.042 / Conectores / connectors / conectores.
 3x IN.15.030 / Tubo standard / Standard tube / tubo estándar (Ø25 X 560mm)

* Esquema com exemplo de carril com 3700 mm, este sistema é modular podendo ser adicionados ou retirados elementos para obter outras dimensões. As referências com * são variáveis segundo as dimensões pretendidas. / Diagram with example of rail with 3700 mm, this system is modular and elements can be added or removed to obtain other dimensions. References with * are variable according to the intended dimension. /

(C) FIXO NO VIDRO / FIXED AT GLASS / FIJA EN CRISTAL CARRIL / RAIL 1900mm

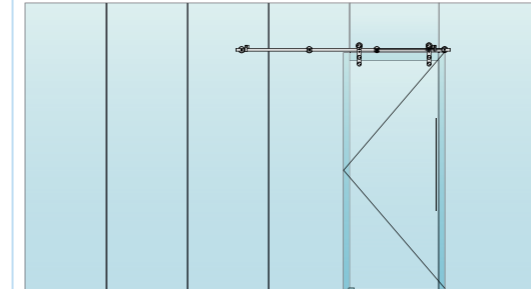

1x IN.15.002 / Roldanas / Wheels / Ruedas
 2x IN.15.012 / Conectores terminais / terminal connectors / conectores terminales
 2x IN.15.011 / Conectores / connectors / conectores.
 4x IN.15.017 / Fixadores para vidro / glass fixings / fijadores para cristal
 3x IN.15.030 / Tubo standard / Standard tube / tubo estándar (Ø25 X 560mm)

(D) FIXAÇÃO AO TECTO E VIDRO / FIXED AT CEILING AND GLASS / FIJO EN TECHO Y CRISTAL CARRIL / RAIL 1900mm

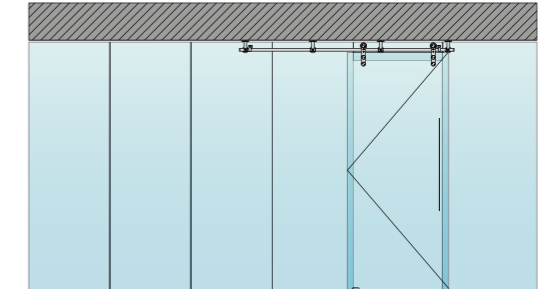

1x IN.15.002 / Roldanas / Wheels / Ruedas
 2x IN.15.047 / Conectores terminais / terminal connectors / conectores terminales
 2x IN.15.046 / Conectores / connectors / conectores.
 3x IN.15.030 / Tubo standard / Standard tube / tubo estándar (Ø25 X 560mm)

* Esquema com exemplo de carril com 3700 mm, este sistema é modular podendo ser adicionados ou retirados elementos para obter outras dimensões. As referências com * são variáveis segundo as dimensões pretendidas. / Diagram with example of rail with 3700 mm, this system is modular and elements can be added or removed to obtain other dimensions. References with * are variable according to the intended dimension. /

BALANCE SYSTEM

SISTEMA MODULAR - PORTAS DE CORRER - Ø25mm
 MODULAR SYSTEM - SLIDING DOORS - Ø25mm
 SISTEMA MODULAR - PUERTAS CORREDERAS - Ø25mm



BALANCE System for glass.

IN.15.601

Material: EN 1.4301
 2x Roldanas
 2x Batentes
 1x Guia de pavimento
 Peso máx de porta 50 Kg
 Espessura de vidro 8 - 10 mm

Material: EN 1.4301
 2x wheels / ruedas
 2x stoppers / frenos
 1x floor guide / guia de suelo
 Max. load / peso max. 50 Kg
 Glass Thickness / Espesor del cristal : 8 - 10mm



VIDRO / GLASS / CRISTAL	x
8mm	14mm
10mm	12mm
12mm	10mm

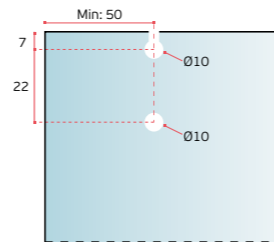
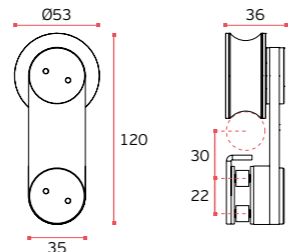
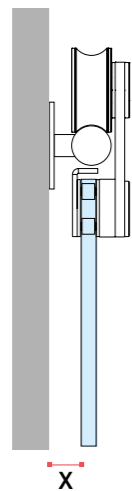

Medidas dos furos a efectuar no vidro / Sizes of the holes to be made in the glass / Medidas de los taladros en el cristal.



EN1527-62-14-13

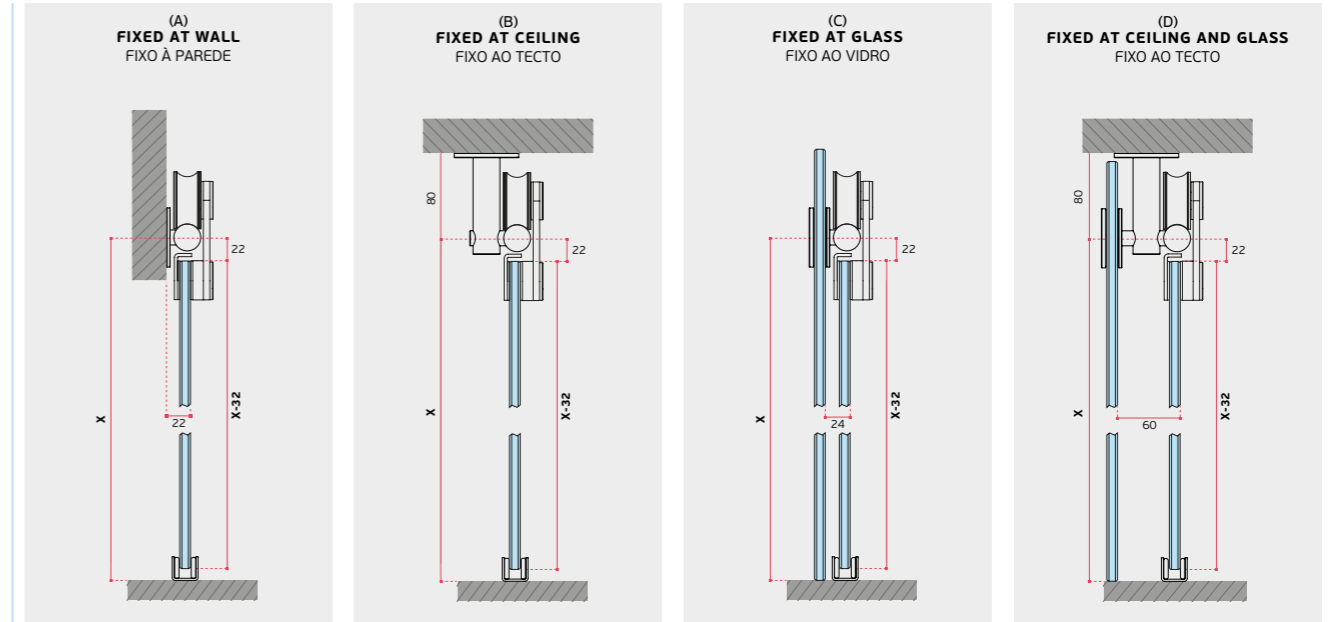

(A) FIXO À PAREDE / FIXED AT WALL / FIJADO A PARED CARRIL / RAIL 1900mm

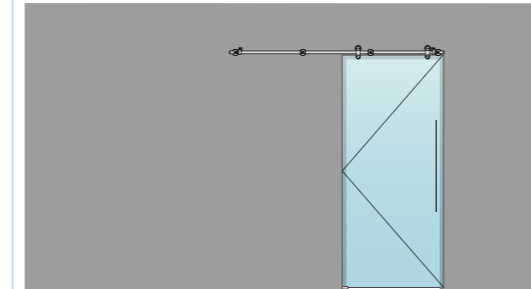

1x IN.15.601 / Roldanas / Wheels / Ruedas
 2x IN.15.012 / Conectores terminais / terminal connectors / conectores terminales
 2x IN.15.011 / Conectores / connectors / conectores.
 3x IN.15.030 / Tubo standard / Standard tube / tubo estándar (Ø25 X 560mm)

(B) FIXAÇÃO AO TECTO / FIXED AT CEILING / FIJO AL TECTO CARRIL / RAIL 1900mm

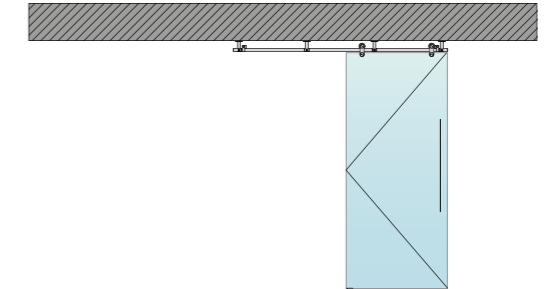

1x IN.15.601 / Roldanas / Wheels / Ruedas
 2x IN.15.043 / Conectores terminais / terminal connectors / conectores terminales
 2x IN.15.042 / Conectores / connectors / conectores.
 3x IN.15.030 / Tubo standard / Standard tube / tubo estándar (Ø25 X 560mm)

* Esquema com exemplo de carril com 3700 mm, este sistema é modular podendo ser adicionados ou retirados elementos para obter outras dimensões. As referências com * são variáveis segundo as dimensões pretendidas. /

Diagram with example of rail with 3700 mm, this system is modular and elements can be added or removed to obtain other dimensions. References with * are variable according to the intended dimension. /

Esquema con ejemplo de carril con 3700 mm, este sistema es modular y se pueden añadir o quitar elementos para obtener otras dimensiones. Las referencias con * son variables según la dimensión prevista.

(C) FIXO NO VIDRO / FIXED AT GLASS / FIJA EN CRISTAL CARRIL / RAIL 1900mm

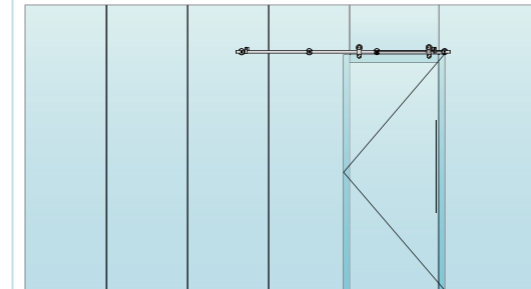

1x IN.15.601 / Roldanas / Wheels / Ruedas
 2x IN.15.012 / Conectores terminais / terminal connectors / conectores terminales
 2x IN.15.011 / Conectores / connectors / conectores.
 4x IN.15.017 / Fixadores para vidro / glass fixings / fijadores para cristal
 3x IN.15.030 / Tubo standard / Standard tube / tubo estándar (Ø25 X 560mm)

(D) FIXAÇÃO AO TECTO E VIDRO / FIXED AT CEILING AND GLASS / FIJO EN TECTO Y CRISTAL CARRIL / RAIL 1900mm

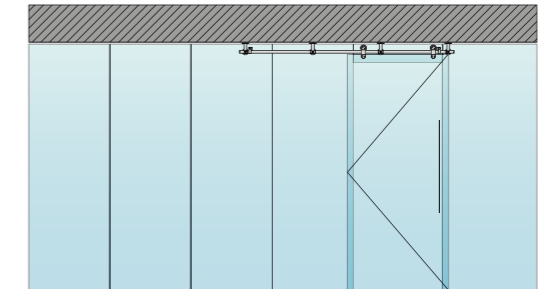

1x IN.15.601 / Roldanas / Wheels / Ruedas
 2x IN.15.047 / Conectores terminais / terminal connectors / conectores terminales
 2x IN.15.046 / Conectores / connectors / conectores.
 3x IN.15.030 / Tubo standard / Standard tube / tubo estándar (Ø25 X 560mm)

* Esquema com exemplo de carril com 3700 mm, este sistema é modular podendo ser adicionados ou retirados elementos para obter outras dimensões. As referências com * são variáveis segundo as dimensões pretendidas. /

Diagram with example of rail with 3700 mm, this system is modular and elements can be added or removed to obtain other dimensions. References with * are variable according to the intended dimension. /

Esquema con ejemplo de carril con 3700 mm, este sistema es modular y se pueden añadir o quitar elementos para obtener otras dimensiones. Las referencias con * son variables según la dimensiones previstas.

TWIN SYSTEM

SISTEMA MODULAR - PORTAS DE CORRER - Ø25mm
MODULAR SYSTEM - SLIDING DOORS - Ø25mm
SISTEMA MODULAR - PUERTAS CORREDERAS - Ø25mm



TWIN System for glass.

IN.15.604

Material: EN 1.4301
2x Roldanas
2x Batentes
1x Guia de pavimento
Peso máx de porta 200 Kg
Espessura de vidro 8 - 12 mm

Material: EN 1.4301
2x wheels / ruedas
2x stoppers / frenos
1x floor guide / guia de suelo
Max. load / peso max. 200Kg
Glass Thickness / Espesor del cristal : 8 - 12mm

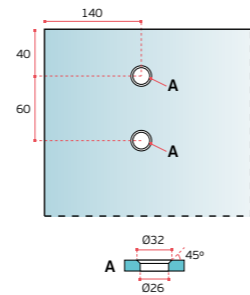
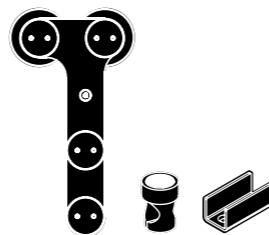

Medidas dos furos
a efectuar no vidro /
Sizes of the holes
to be made in the glass /
Medidas de los taladros
en el cristal.

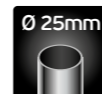

VIDRO / GLASS / CRISTAL	X
8mm	18mm
10mm	16mm
12mm	14mm

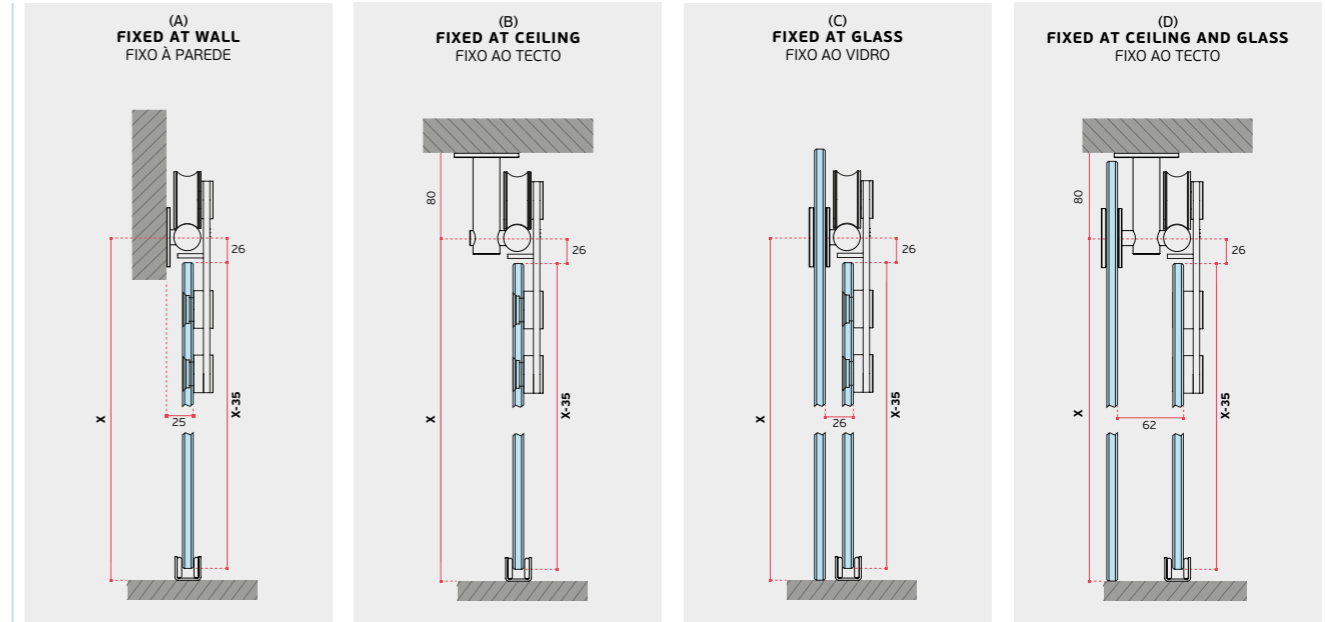
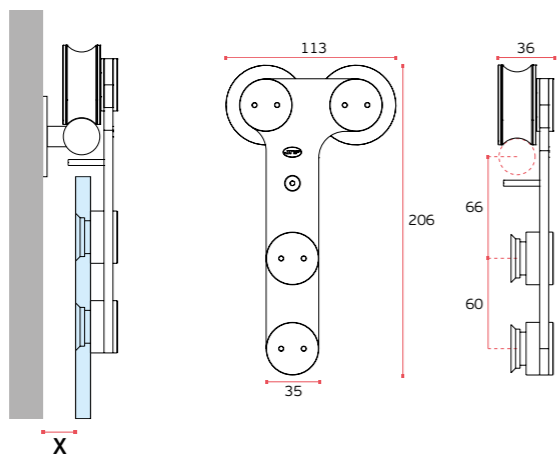

(A) FIXO À PAREDE /
FIXED AT WALL /
FIJADO A PARED

CARRIL / RAIL
1900mm

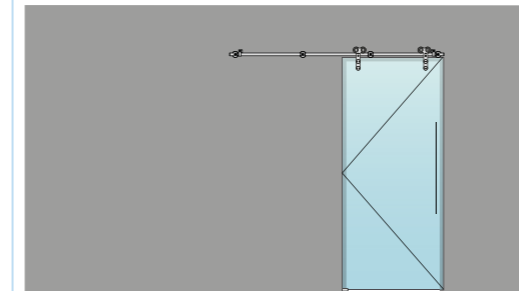

1x IN.15.604 / Roldanas / Wheels / Ruedas
2x IN.15.012 / Conectores terminais /
terminal connectors / conectores terminales
2x IN.15.011 / Conectores / connectors / conectores.
3x IN.15.030 / Tubo standard / Standard tube / tubo estándar
(Ø25 X 560mm)

(B) FIXAÇÃO AO TECTO /
FIXED AT CEILING /
FIJO AL TECTO

CARRIL / RAIL
1900mm

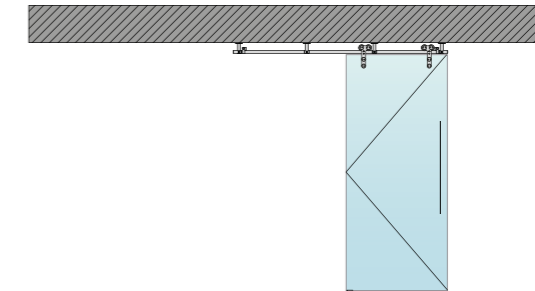

1x IN.15.604 / Roldanas / Wheels / Ruedas
2x IN.15.043 / Conectores terminais /
terminal connectors / conectores terminales
2x IN.15.042 / Conectores / connectors / conectores.
3x IN.15.030 / Tubo standard / Standard tube / tubo estándar
(Ø25 X 560mm)

*
Esquema com exemplo de carril
com 3700 mm, este sistema é
modular podendo ser adicionados
ou retirados elementos para obter
outras dimensões. As referências
com * são variáveis segundo as
dimensões pretendidas. /

Diagram with example of rail with
3700 mm, this system is modular and
elements can be added or removed to
obtain other dimensions. References
with * are variable according to the
intended dimension. /

Esquema con ejemplo de carril con
3700 mm, este sistema es modular y
se pueden añadir o quitar elementos
para obtener otras dimensiones. Las
referencias con * son variables según
la dimensión prevista.

(C) FIXO NO VIDRO /
FIXED AT GLASS /
FIJA EN CRISTAL

CARRIL / RAIL
1900mm

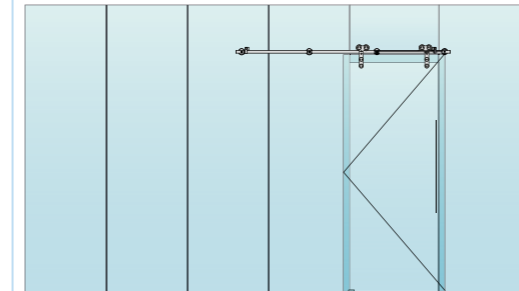

1x IN.15.604 / Roldanas / Wheels / Ruedas
2x IN.15.012 / Conectores terminais /
terminal connectors / conectores terminales
2x IN.15.011 / Conectores / connectors / conectores.
4x IN.15.017 / Fixadores para vidro / glass fixings / fijadores para
cristal
3x IN.15.030 / Tubo standard / Standard tube / tubo estándar
(Ø25 X 560mm)

(D) FIXAÇÃO AO TECTO E VIDRO /
FIXED AT CEILING AND GLASS /
FIJO EN TECTO Y CRISTAL

CARRIL / RAIL
1900mm

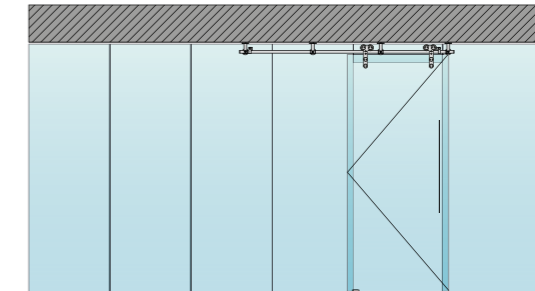

1x IN.15.604 / Roldanas / Wheels / Ruedas
2x IN.15.047 / Conectores terminais /
terminal connectors / conectores terminales
2x IN.15.046 / Conectores / connectors / conectores.
3x IN.15.030 / Tubo standard / Standard tube / tubo estándar
(Ø25 X 560mm)

*
Esquema com exemplo de carril
com 3700 mm, este sistema é
modular podendo ser adicionados
ou retirados elementos para obter
outras dimensões. As referências
com * são variáveis segundo as
dimensões pretendidas. /

Diagram with example of rail with
3700 mm, this system is modular and
elements can be added or removed to
obtain other dimensions. References
with * are variable according to the
intended dimension. /

Esquema con ejemplo de carril con
3700 mm, este sistema es modular y
se pueden añadir o quitar elementos
para obtener otras dimensiones. Las
referencias con * son variables según
la dimensiones previstas.

ROLLERBLADE SYSTEM

SISTEMA MODULAR - PORTAS DE CORRER - Ø25mm
MODULAR SYSTEM - SLIDING DOORS - Ø25mm
SISTEMA MODULAR - PUERTAS CORREDERAS - Ø25mm



ROLLERBLADE System for glass.

IN.15.606

Material: EN 1.4301
2x Roldanas
2x Batentes
1x Guia de pavimento
Peso máx de porta 220 Kg
Espessura de vidro 8 - 12 mm

Material: EN 1.4301
2x wheels / ruedas
2x stoppers / frenos
1x floor guide / guía de suelo
Max. load / peso max. 220Kg
Glass Thickness / Espesor del cristal : 8 - 12mm

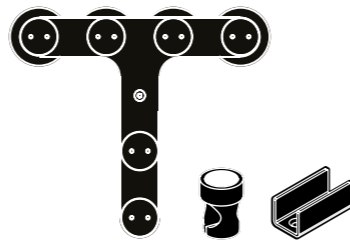

VIDRO / GLASS / CRISTAL	X
8mm	18mm
10mm	16mm
12mm	14mm

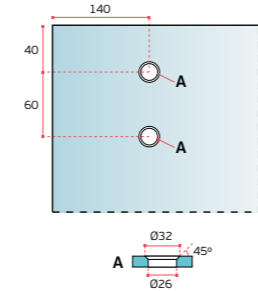
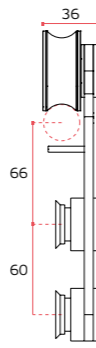
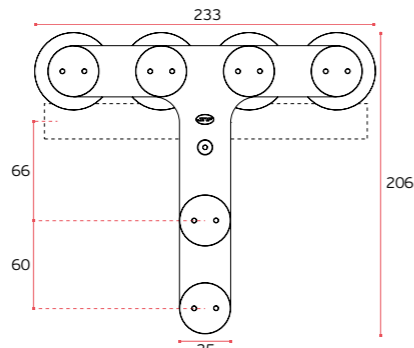
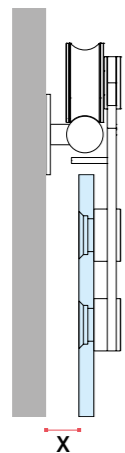

Medidas dos furos
a efectuar no vidro /
Sizes of the holes
to be made in the glass /
Medidas de los taladros
en el cristal.

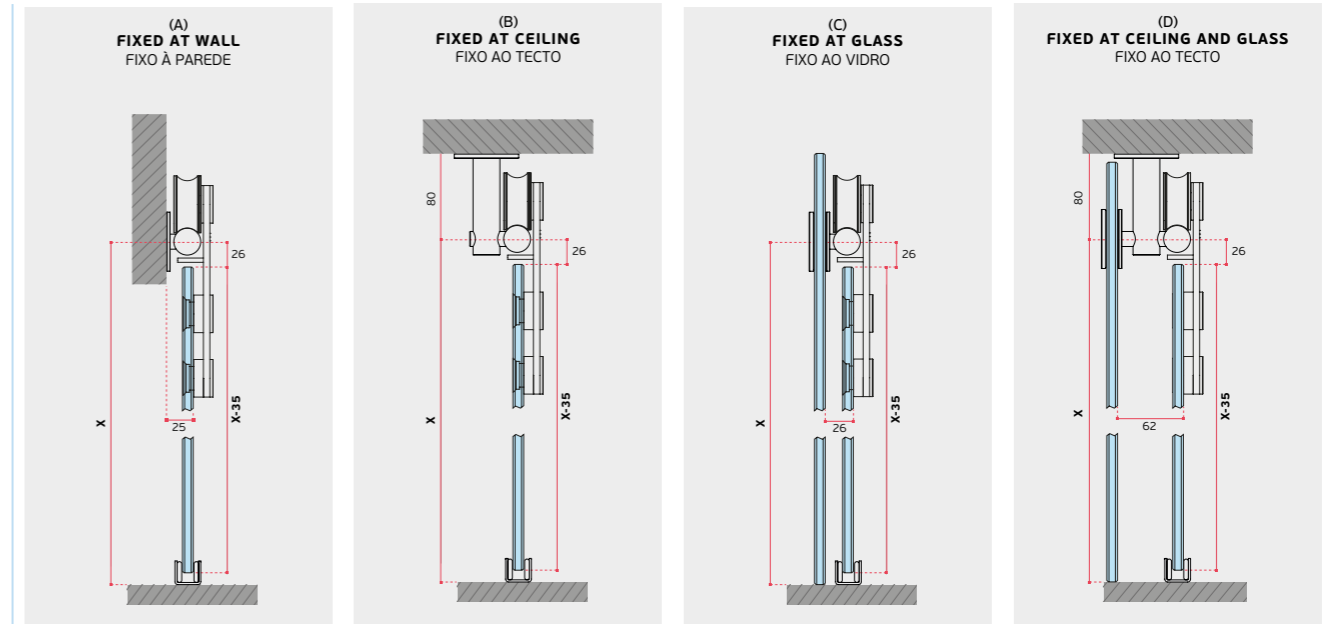
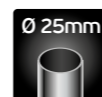

(A) FIXO À PAREDE /
FIXED AT WALL / FIJADO A PARED

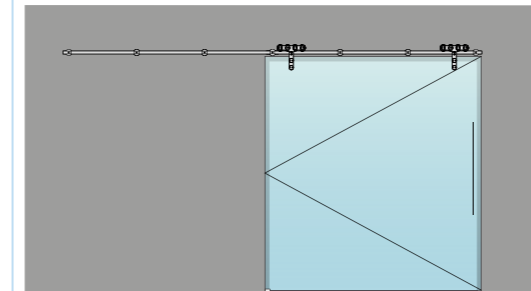

1x IN.15.601 / Roldanas / Wheels / Ruedas
2x IN.15.012* / Conectores terminais /
terminal connectors / conectores terminales
2x IN.15.011* / Conectores / connectors / conectores.
3x IN.15.030* / Tubo standard / Standard tube / tubo estándar
(Ø25 X 560mm)

CARRIL / RAIL
3700mm

(B) FIXAÇÃO AO TECTO /
FIXED AT CEILING / FIJO AL TECHO

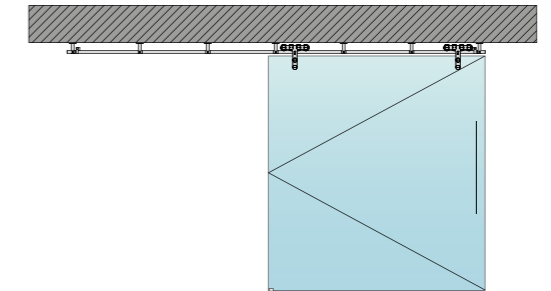

1x IN.15.601 / Roldanas / Wheels / Ruedas
2x IN.15.043* / Conectores terminais /
terminal connectors / conectores terminales
2x IN.15.042* / Conectores / connectors / conectores.
3x IN.15.030* / Tubo standard / Standard tube / tubo estándar
(Ø25 X 560mm)

CARRIL / RAIL
3700mm

*
Esquema com exemplo de carril
com 3700 mm, este sistema é
modular podendo ser adicionados
ou retirados elementos para obter
outras dimensões. As referências
com * são variáveis segundo as
dimensões pretendidas. /

Diagram with example of rail with
3700 mm, this system is modular and
elements can be added or removed to
obtain other dimensions. References
with * are variable according to the
intended dimension. /

Esquema con ejemplo de carril con
3700 mm, este sistema es modular y
se pueden añadir o quitar elementos
para obtener otras dimensiones. Las
referencias con * son variables según
la dimensión prevista.

(C) FIXO NO VIDRO /
FIXED AT GLASS / FIJA EN CRISTAL

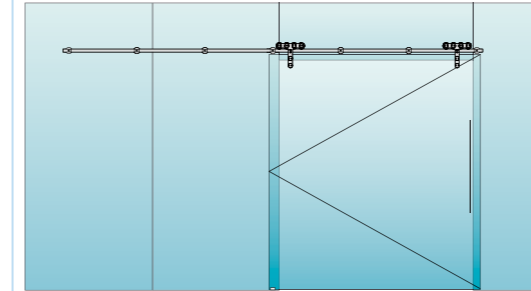

1x IN.15.601 / Roldanas / Wheels / Ruedas
2x IN.15.012* / Conectores terminais /
terminal connectors / conectores terminales
2x IN.15.011* / Conectores / connectors / conectores.
4x IN.15.017* / Fixadores para vidro /
glass fixings / fijadores para cristal
3x IN.15.030* / Tubo standard / Standard tube / tubo estándar
(Ø25 X 560mm)

CARRIL / RAIL
3700mm

(D) FIXAÇÃO AO TECTO E VIDRO /
FIXED AT CEILING AND GLASS / FIJO EN TECHO Y CRISTAL

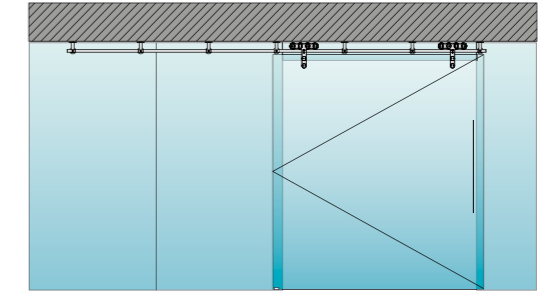

1x IN.15.601 / Roldanas / Wheels / Ruedas
2x IN.15.047* / Conectores terminais /
terminal connectors / conectores terminales
2x IN.15.046* / Conectores / connectors / conectores.
3x IN.15.030* / Tubo standard / Standard tube / tubo estándar
(Ø25 X 560mm)

CARRIL / RAIL
3700mm

*
Esquema com exemplo de carril
com 3700 mm, este sistema é
modular podendo ser adicionados
ou retirados elementos para obter
outras dimensões. As referências
com * são variáveis segundo as
dimensões pretendidas. /

Diagram with example of rail with
3700 mm, this system is modular and
elements can be added or removed to
obtain other dimensions. References
with * are variable according to the
intended dimension. /

Esquema con ejemplo de carril con
3700 mm, este sistema es modular y
se pueden añadir o quitar elementos
para obtener otras dimensiones. Las
referencias con * son variables según
la dimensiones previstas.

SINCRO SYSTEM

SISTEMA MODULAR - PORTAS DE CORRER - Ø25mm
MODULAR SYSTEM - SLIDING DOORS - Ø25mm
SISTEMA MODULAR - PUERTAS CORREDERAS - Ø25mm

SINCRO SYSTEM FOR GLASS

*A forma evidente
de sincronizar o movimento!
Tudo é aparente funcionando sem
segredos, um cabo de aço encarrega-se
da transmissão de movimentos. O deslize
das portas é suave e cria uma sensação
de movimento transparente, apelando ao
carácter elementar com que muitas coisas
simples podem ser feitas. As portas abrem e
fecham simultâneamente sendo
operadas manualmente.*

*The obvious way to synchronize the movement!
Everything is running without apparent secrets,
a steel cable is responsible for the transmission
of movements. The slide of the doors is
smooth and creates a feeling of transparent
movement, appealing to the elementary way
that many simple things can be done. The
doors open and close while being
operated manually.*

*La manera obvia de sincronizar el movimiento!
Todo esta funcionando sin secretos, un cable
de acero es responsable por la transmision
de los movimientos. El deslice de las puertas
es suave y crea una sensacion de movimiento
transparente, que apela al caracter elementar
con que muchas cosas simples se pueden
hacer. Las puertas se abren y se cierran en
simultáneo y se accionan manualmente.*

SINCRO SYSTEM

SISTEMA MODULAR - PORTAS DE CORRER - Ø25mm
MODULAR SYSTEM - SLIDING DOORS - Ø25mm
SISTEMA MODULAR - PUERTAS CORREDERAS - Ø25mm

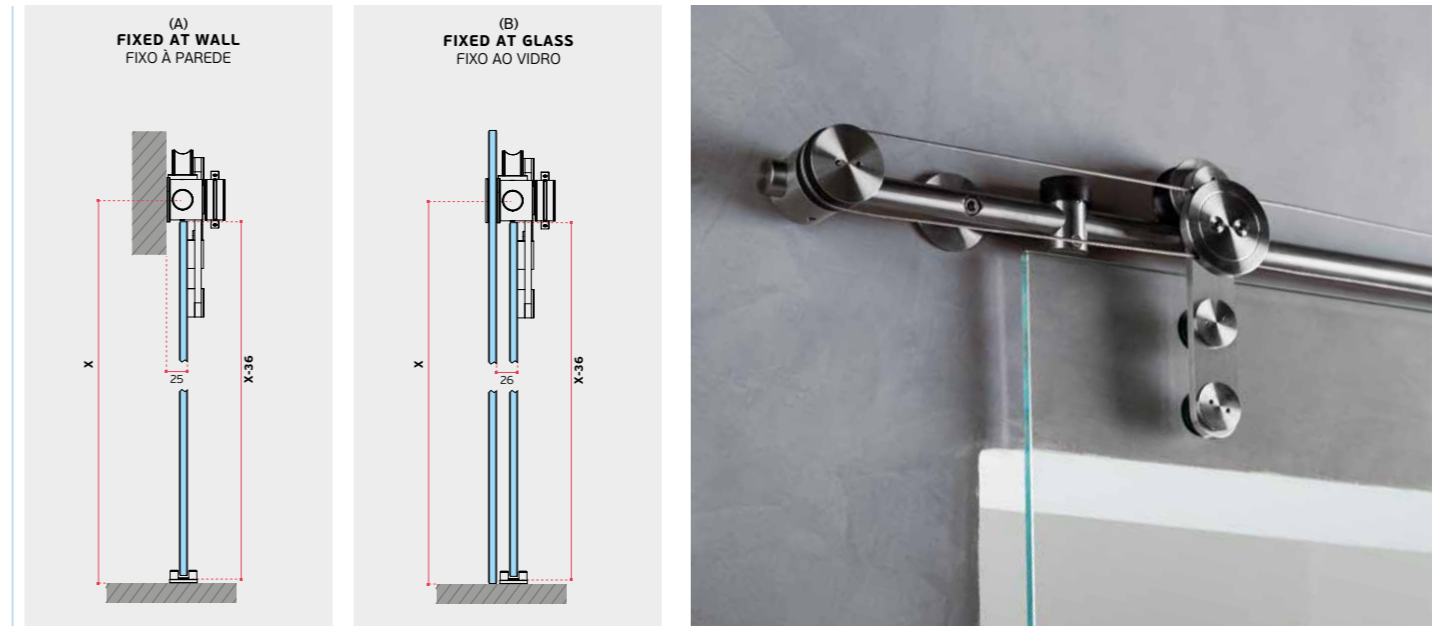

(A) FIXO À PAREDE /
FIXED AT WALL /
FIJADO A PARED

CARRIL / RAIL
3860mm

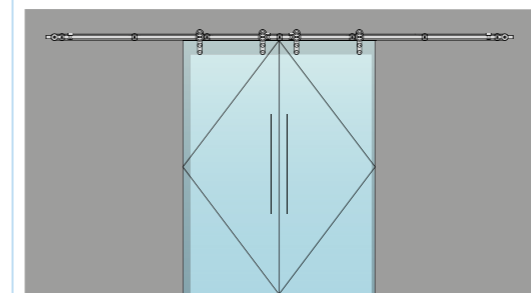

1x IN.15.202 / Roldanas / Wheels / Ruedas
5x IN.15.011 / Conectores / connectors / conectores.
6x IN.15.030 / Tubo standard / Standard tube / tubo estándar
(Ø25 X 560mm)

(C) FIXO NO VIDRO /
FIXED AT GLASS /
FIJA EN Cristal

CARRIL / RAIL
3860mm

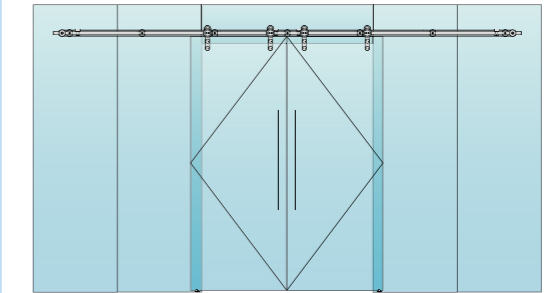

1x IN.15.202 / Roldanas / Wheels / Ruedas
5x IN.15.011 / Conectores / connectors / conectores.
7x IN.15.017 / Fixadores para vidro / glass fixings / fijadores para cristal
6x IN.15.030 / Tubo standard / Standard tube / tubo estándar
(Ø25 X 560mm)

*
Esquema com exemplo de carril com 3860 mm, este sistema é modular podendo ser adicionados ou retirados elementos para obter outras dimensões. As referências com * são variáveis segundo as dimensões pretendidas. /

Diagram with example of rail with 3860 mm, this system is modular and elements can be added or removed to obtain other dimensions. References with * are variable according to the intended dimension. /

Esquema con ejemplo de carril con 3860mm, este sistema es modular y se pueden añadir o quitar elementos para obtener otras dimensiones. Las referencias con * son variables según la dimensión prevista.

SINCRO System for glass.

IN.15.202

Material: EN 1.4301
4x Roldanas
2x Batentes
2x Guia de pavimento
10mt - Cabo de aço 2,5mm
Peso máx de porta 120 Kg
Espessura de vidro 8 - 12 mm

Material: EN 1.4301
2x wheels / ruedas
2x stoppers / frenos
1x floor guide / guia de suelo
Wire rope 2,5mm / Cable de acero 2,5mm
Max. load / peso max. 120 Kg
Glass Thickness / Espesor del cristal : 8 - 12mm

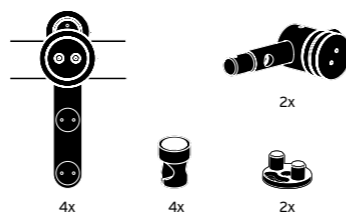

VIDRO / GLASS / CRISTAL	X
8mm	18mm
10mm	16mm
12mm	14mm

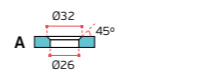
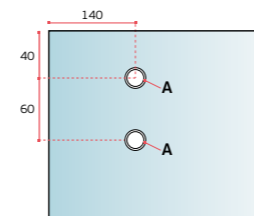
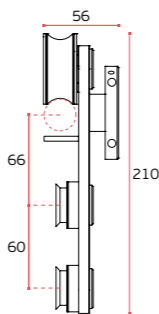
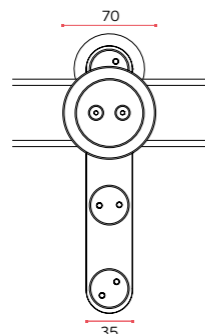
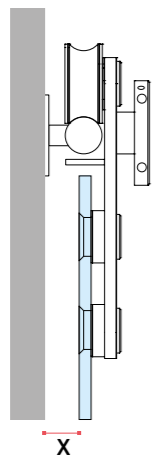

Medidas dos furos a efectuar no vidro /
Sizes of the holes to be made in the glass /
Medidas de los taladros en el cristal.



CLEAR TWIN SYSTEM

SISTEMA MODULAR - PORTAS DE CORRER - 025mm
MODULAR SYSTEM - SLIDING DOORS - 025mm
SISTEMA MODULAR - PUERTAS CORREDERAS - 025mm

CLEAR SYSTEM FOR GLASS

A roldana para vidro com menos impacto visual. Clear system foi desenvolvido para que o sistema deslizante acolha o tubo com 2 rodas de pequeno diâmetro mas com capacidade para 120KG por porta.

The glass wheels with the least visual impact. Clear system was developed so that the sliding system embraces the tube with 2 wheels with a small diameter but with a capacity of 120KG per door.

Las ruedas para puerta de cristal con el menor impacto visual. Clear system fue desarrollado para que el sistema deslizante abrace el tubo con 2 ruedas de pequeño diámetro pero con una capacidad de 120KG por puerta.

CLEAR TWIN SYSTEM

SISTEMA MODULAR - PORTAS DE CORRER - Ø25mm
 MODULAR SYSTEM - SLIDING DOORS - Ø25mm
 SISTEMA MODULAR - PUERTAS CORREDERAS - Ø25mm



CLEAR TWIN System for glass.

IN.15.007
 Material: EN 1.4301
 2x Roldanas
 2x Batentes
 1x Guia de pavimento
 Peso máx de porta 120 Kg
 Espessura de vidro 8 - 12 mm

Material: EN 1.4301
 2x wheels / ruedas
 2x stoppers / frenos
 1x floor guide / guía de suelo
 Max. load / peso max. 120 Kg
 Glass Thickness / Espesor del cristal : 8 - 12mm

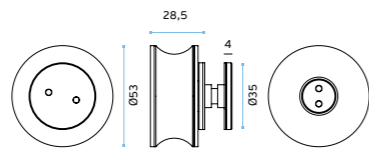
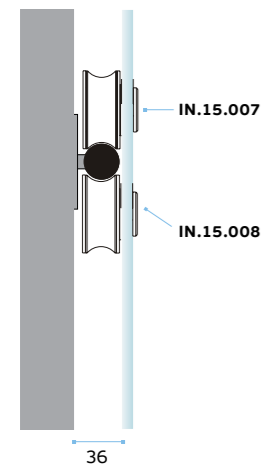
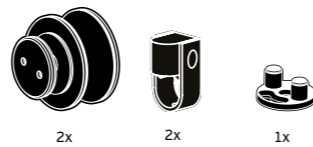

IN.15.008
 2x Roldanas /
 2x wheels / 2x ruedas

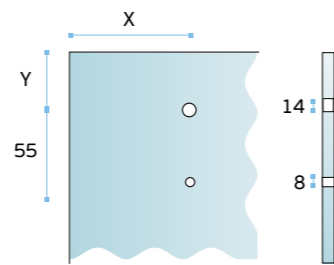
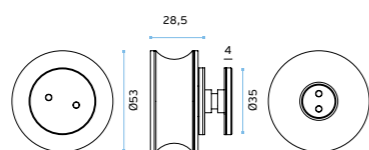

Medidas dos furos a efectuar no vidro /
 Sizes of the holes to be made in the glass /
 Medidas de los taladros en el cristal.

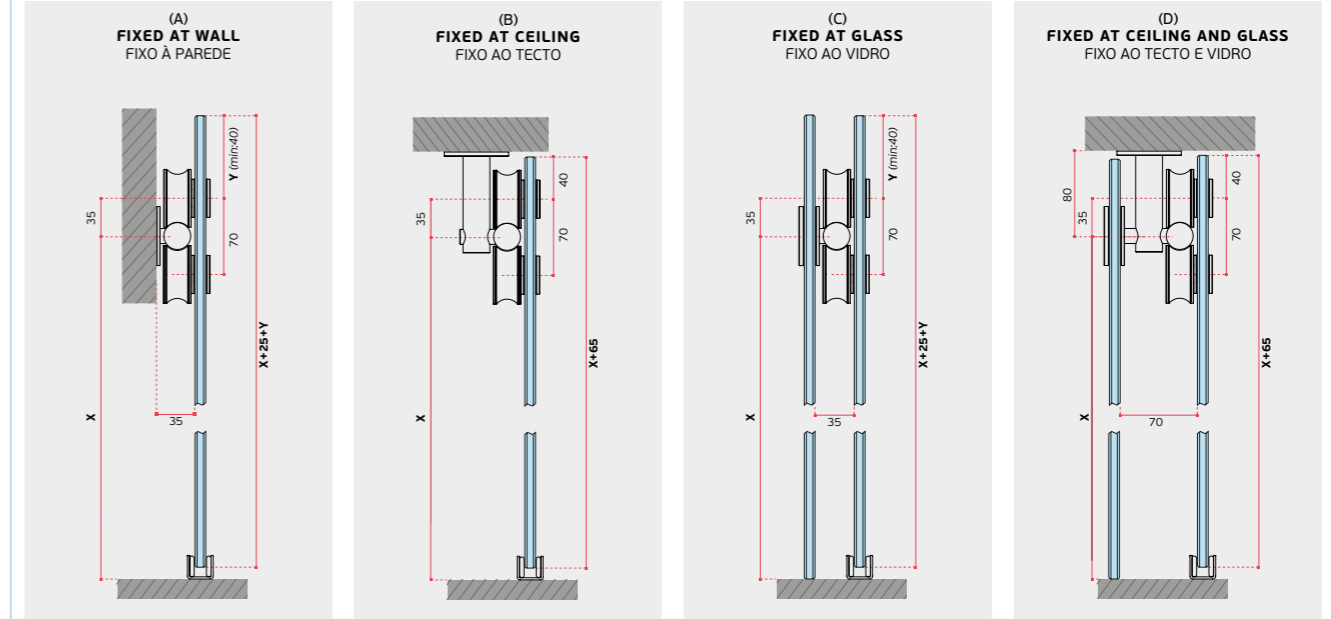
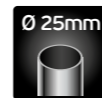

(A) FIXO À PAREDE /
 FIXED AT WALL /
 FIJADO A PARED

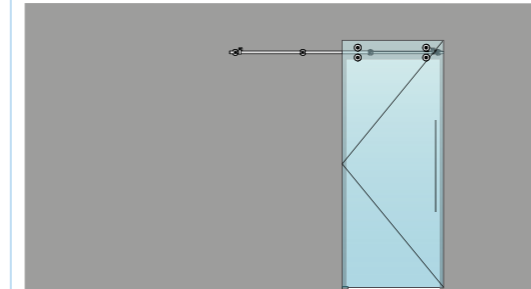

1x IN.15.007 / Roldanas / Wheels / Ruedas
1x IN.15.008 / Roldanas / Wheels / Ruedas
2x IN.15.012* / Conectores terminais / terminal connectors / conectores terminales
2x IN.15.011* / Conectores / connectors / conectores.
3x IN.15.030* / Tubo standard / Standard tube / tubo estándar (Ø25 X 560mm)

CARRIL / RAIL
 1900mm

(B) FIXAÇÃO AO TECTO /
 FIXED AT CEILING /
 FIJO AL TECTO

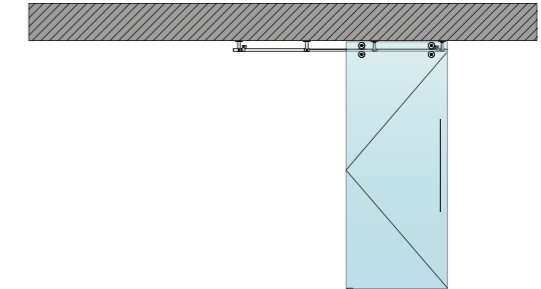

1x IN.15.007 / Roldanas / Wheels / Ruedas
1x IN.15.008 / Roldanas / Wheels / Ruedas
2x IN.15.043* / Conectores terminais / terminal connectors / conectores terminales
2x IN.15.042* / Conectores / connectors / conectores.
3x IN.15.030* / Tubo standard / Standard tube / tubo estándar (Ø25 X 560mm)

CARRIL / RAIL
 1900mm

* Esquema com exemplo de carril com 1900mm, este sistema é modular podendo ser adicionados ou retirados elementos para obter outras dimensões. As referências com * são variáveis segundo as dimensões pretendidas. /

Diagram with example of rail with 1900mm, this system is modular and elements can be added or removed to obtain other dimensions. References with * are variable according to the intended dimension. /

Esquema com exemplo de carril com 1900mm, este sistema é modular y se pueden añadir o quitar elementos para obtener otras dimensiones. Las referencias con * son variables según la dimensión prevista.

(C) FIXO NO VIDRO /
 FIXED AT GLASS /
 FIJO EN Cristal

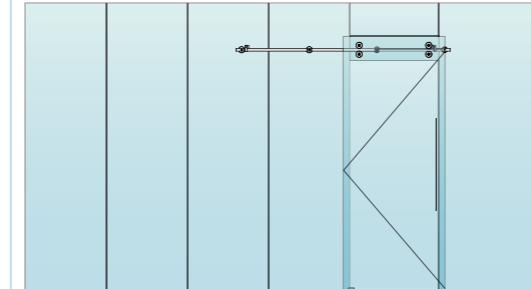

1x IN.15.007 / Roldanas / Wheels / Ruedas
1x IN.15.008 / Roldanas / Wheels / Ruedas
2x IN.15.012* / Conectores terminais / terminal connectors / conectores terminales
2x IN.15.011* / Conectores / connectors / conectores.
4x IN.15.017* / Fixadores para vidro / glass fixings / fijadores para cristal
3x IN.15.030* / Tubo standard / Standard tube / tubo estándar (Ø25 X 560mm)

CARRIL / RAIL
 1900mm

(D) FIXAÇÃO AO TECTO E VIDRO /
 FIXED AT CEILING AND GLASS /
 FIJO EN TECTO Y Cristal

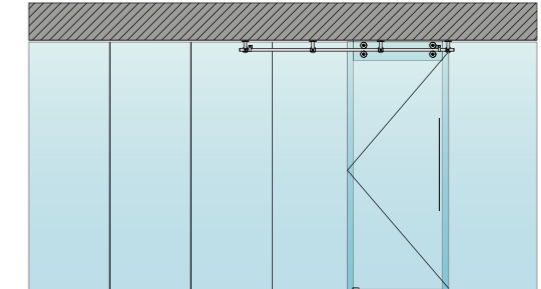

1x IN.15.007 / Roldanas / Wheels / Ruedas
1x IN.15.008 / Roldanas / Wheels / Ruedas
2x IN.15.047* / Conectores terminais / terminal connectors / conectores terminales
2x IN.15.046* / Conectores / connectors / conectores.
3x IN.15.030* / Tubo standard / Standard tube / tubo estándar (Ø25 X 560mm)

CARRIL / RAIL
 1900mm

* Esquema com exemplo de carril com 1900mm, este sistema é modular podendo ser adicionados ou retirados elementos para obter outras dimensões. As referências com * são variáveis segundo as dimensões pretendidas. /

Diagram with example of rail with 1900mm, this system is modular and elements can be added or removed to obtain other dimensions. References with * are variable according to the intended dimension. /

Esquema com exemplo de carril com 1900mm, este sistema é modular y se pueden añadir o quitar elementos para obtener otras dimensiones. Las referencias con * son variables según la dimensión prevista.

CLEAR SYSTEM

SISTEMA MODULAR - PORTAS DE CORRER - Ø25mm
 MODULAR SYSTEM - SLIDING DOORS - Ø25mm
 SISTEMA MODULAR - PUERTAS CORREDERAS - Ø25mm



CLEAR System for glass.

IN.15.007
 Material: EN 1.4301
 2x Roldanas
 2x Batentes
 1x Guia de pavimento
 Peso máx de porta 120 Kg
 Espessura de vidro 8 - 12 mm

Material: EN 1.4301
 2x wheels / ruedas
 2x stoppers / frenos
 1x floor guide / guía de suelo
 Max. load / peso max. 120 Kg
 Glass Thickness / Espesor del cristal : 8 - 12mm

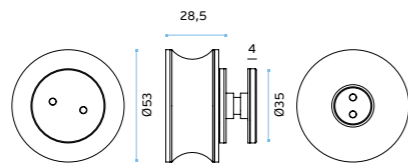
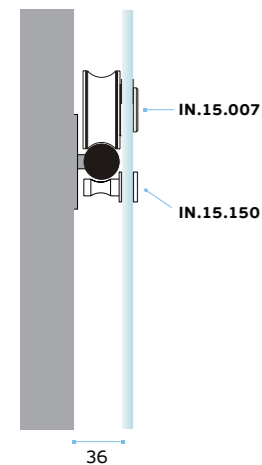
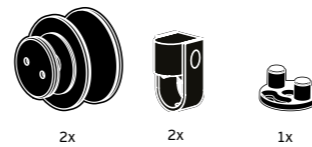

IN.15.150
 1x - Pino de segurança / Security pin / Pino de seguridad

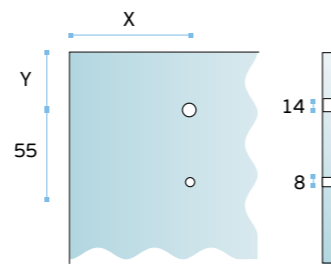
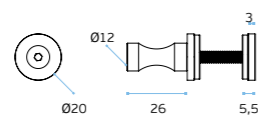

Medidas dos furos a efectuar no vidro / Sizes of the holes to be made in the glass / Medidas de los taladros en el cristal.

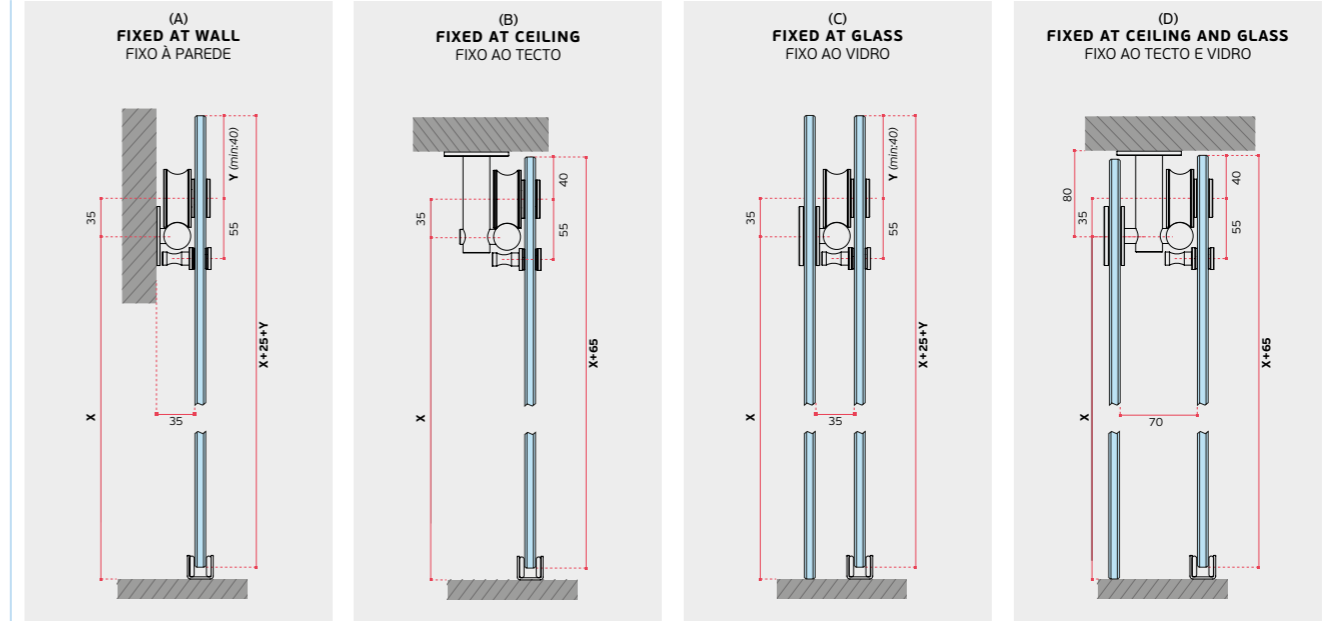
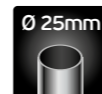

(A) FIXO À PAREDE / FIXED AT WALL / FIJADO A PARED

CARRIL / RAIL 1900mm

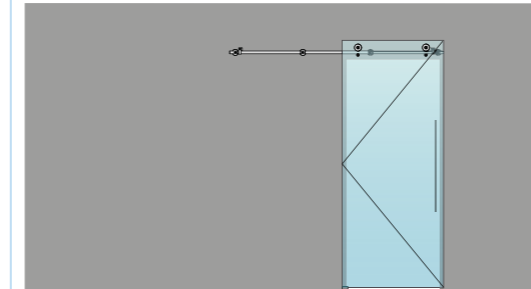

1x IN.15.007 / Roldanas / Wheels / Ruedas
 2x IN.15.150 - Pino de segurança / Security pin / Pino de seguridad
 2x IN.15.012 / Conectores terminais / terminal connectors / conectores terminales
 2x IN.15.011 / Conectores / connectors / conectores.
 3x IN.15.030 / Tubo standard / Standard tube / tubo estándar (Ø25 X 560mm)

(B) FIXAÇÃO AO TECTO / FIXED AT CEILING / FIJO AL TECTO

CARRIL / RAIL 1900mm

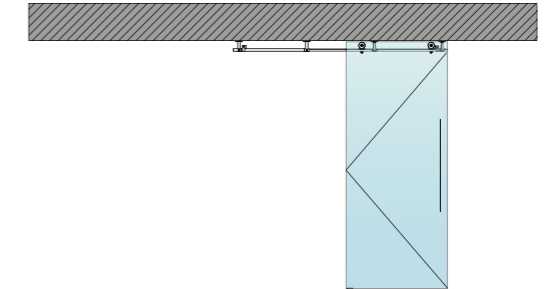

1x IN.15.007 / Roldanas / Wheels / Ruedas
 2x IN.15.150 - Pino de segurança / Security pin / Pino de seguridad
 2x IN.15.043 / Conectores terminais / terminal connectors / conectores terminales
 2x IN.15.042 / Conectores / connectors / conectores.
 3x IN.15.030 / Tubo standard / Standard tube / tubo estándar (Ø25 X 560mm)

* Esquema com exemplo de carril com 1900mm, este sistema é modular podendo ser adicionados ou retirados elementos para obter outras dimensões. As referências com * são variáveis segundo as dimensões pretendidas. /

Diagram with example of rail with 1900mm, this system is modular and elements can be added or removed to obtain other dimensions. References with * are variable according to the intended dimension. /

Esquema con ejemplo de carril con 1900mm, este sistema es modular y se pueden añadir o quitar elementos para obtener otras dimensiones. Las referencias con * son variables según la dimensión prevista.

(C) FIXO NO VIDRO / FIXED AT GLASS / FIJO EN CRISTAL

CARRIL / RAIL 1900mm

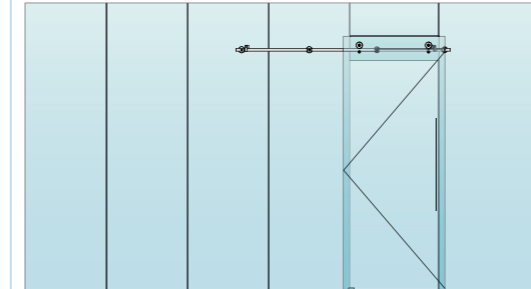

1x IN.15.007 / Roldanas / Wheels / Ruedas
 2x IN.15.150 - Pino de segurança / Security pin / Pino de seguridad
 2x IN.15.012 / Conectores terminais / terminal connectors / conectores terminales
 2x IN.15.011 / Conectores / connectors / conectores.
 4x IN.15.017 / Fixadores para vidro / glass fixings / fijadores para cristal
 3x IN.15.030 / Tubo standard / Standard tube / tubo estándar (Ø25 X 560mm)

(D) FIXAÇÃO AO TECTO E VIDRO / FIXED AT CEILING AND GLASS / FIJO EN TECTO Y CRISTAL

CARRIL / RAIL 1900mm

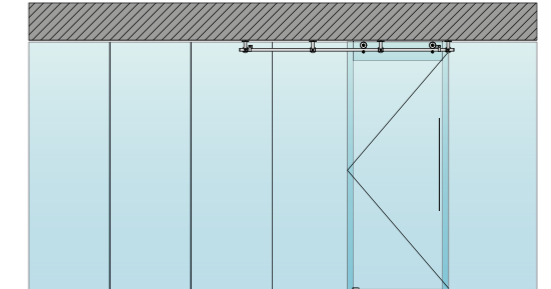

1x IN.15.007 / Roldanas / Wheels / Ruedas
 2x IN.15.150 - Pino de segurança / Security pin / Pino de seguridad
 2x IN.15.047 / Conectores terminais / terminal connectors / conectores terminales
 2x IN.15.046 / Conectores / connectors / conectores.
 3x IN.15.030 / Tubo standard / Standard tube / tubo estándar (Ø25 X 560mm)

* Esquema com exemplo de carril com 1900mm, este sistema é modular podendo ser adicionados ou retirados elementos para obter outras dimensões. As referências com * são variáveis segundo as dimensões pretendidas. /

Diagram with example of rail with 1900mm, this system is modular and elements can be added or removed to obtain other dimensions. References with * are variable according to the intended dimension. /

Esquema con ejemplo de carril con 1900mm, este sistema es modular y se pueden añadir o quitar elementos para obtener otras dimensiones. Las referencias con * son variables según la dimensión prevista.

A

Acessórios portas de correr Ø25mm /**Accessories for sliding door systems Ø25mm /****Accesorios para sistemas de puerta correderas Ø25mm.**Ø25
mm**IN.15.030**

Tube standard aplicável a qualquer suporte de parede ou tecto. Esta peça pode ser cortada. Diâmetro e espessura da parede 25x2mm / Standard tube applicable to any wall or ceiling support. This part can be cutted. Diameter and thickness of the wall 25x2mm /

Tubo estándar aplicable a cualquier soporte de pared o de techo. Esta parte puede ser cortada. Diámetro y espesor de la pared 25x2mm.

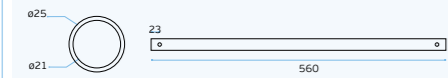
MATERIAL: EN 1.4301 AISI 304**CARGA MÁX. / MAX. LOAD:** 120 KG**IN.15.031**

Tube para medidas especiais aplicável a qualquer suporte de parede ou tecto. Esta peça tem de ser cortada podendo ser utilizada com uma medida máxima de 1000mm / Tube for special dimensions applicable to any wall or ceiling support. This part must be cutted maximum length 1000mm /

Tubo para medidas especiales aplicable a cualquier soporte de pared o de techo. Esta parte tiene que ser cortada. Máximo ancho 1000 mm.

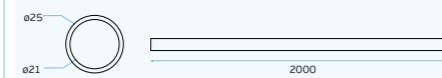
MATERIAL: EN 1.4301 AISI 304**CARGA MÁX. / MAX. LOAD:** 60 KG**IN.15.032**

Tube para medidas especiais aplicável a qualquer suporte de parede ou tecto / Tube for special dimensions applicable to any wall or ceiling support /

Tubo para medidas especiales aplicable a cualquier soporte de pared o de techo.

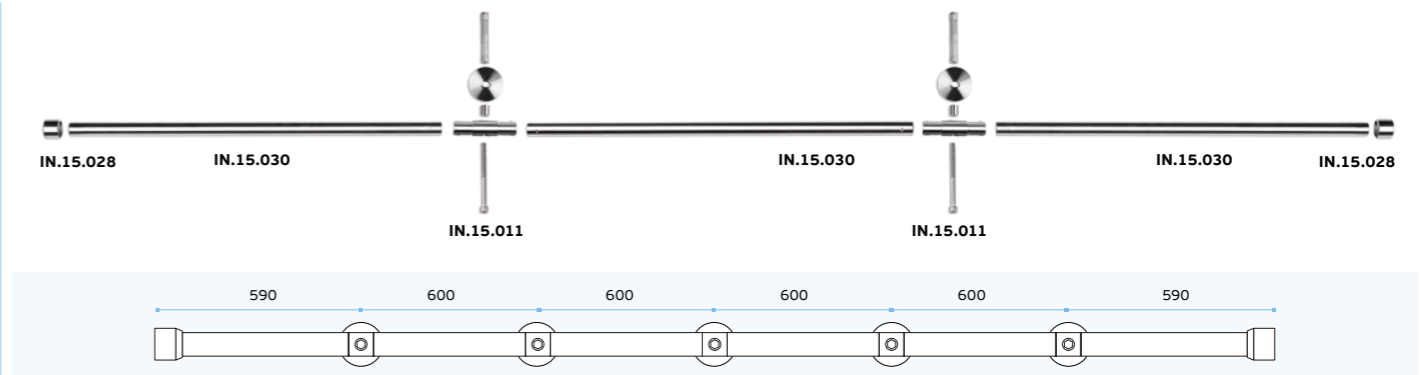
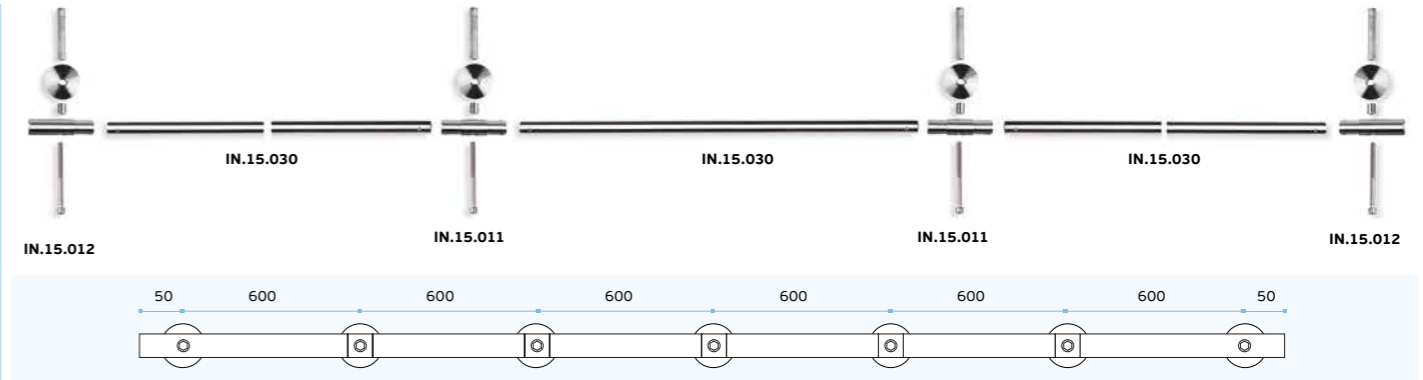
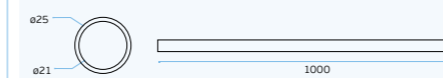
MATERIAL: EN 1.4301 AISI 304**CARGA MÁX. / MAX. LOAD:** 60 KG**IN.15.011**

Conector e suporte de parede para aplicar numa parede/suporte paralelo à porta, através de um parafuso M8 e bucha adequada / Connector and wall support to be applied to a wall/ support parallel to the door, using an M8 screw and suitable plug / Conector y soporte de pared para aplicar en una pared paralela a la puerta, através de un tornillo M8 y taco apropiado.

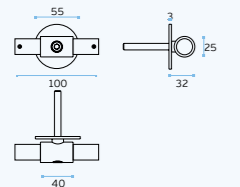
MATERIAL: EN 1.4301 AISI 304**IN.15.012**

Conector/terminal e suporte de parede para aplicar numa parede/suporte paralelo à porta, através de um parafuso M8 e bucha adequada / Connector/terminal and wall support to be applied to a wall/ support parallel to the door, using an M8 screw and suitable plug / Conector/terminal y soporte de pared para aplicar en una pared paralela a la puerta, através de un tornillo M8 y taco apropiado.

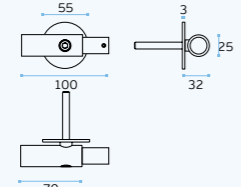
MATERIAL: EN 1.4301 AISI 304**IN.15.042**

Suporte ao tecto para aplicar sistema suspenso ao tecto. Este suporte inclui o conector para os tubos / Ceiling support to apply suspended system to the ceiling. This support includes the connector for the tubes / Soporte de techo para aplicar sistema suspendido en lo techo. Este soporte incluido lo conector para los tubos.

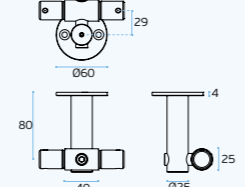
MATERIAL: EN 1.4301 AISI 304**IN.15.043**

Suporte ao tecto, para aplicar sistema suspenso ao tecto. Este suporte inclui o conector para os tubos / Ceiling support to apply suspended system to the ceiling. This support includes the connector for the tubes / Soporte de techo, para aplicar sistema suspendido en lo techo. Este soporte incluido lo conector para los tubos.

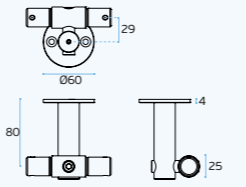
MATERIAL: EN 1.4301 AISI 304**IN.15.044**

Suporte ao tecto duplo para aplicar sistema suspenso ao tecto com portas sobrepostas. Este suporte inclui os conectores para os tubos / Double ceiling support to apply suspended system to the ceiling with overlapped sliding doors. This support includes the connectors for the tubes / Soporte doble de techo para aplicar en el sistema suspendido en el techo con las puertas deslizantes traslapadas. Este soporte incluido los conectores para los tubos.

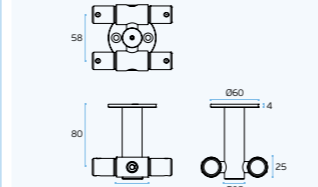
MATERIAL: EN 1.4301 AISI 304**IN.15.045**

Suporte ao tecto duplo com terminais para aplicar sistema suspenso ao tecto com portas sobrepostas. Inclui os conectores para os tubos / Double ceiling support and terminals to apply suspended system to the ceiling with overlapped sliding doors. Includes the connectors for the tubes / Soporte doble de techo y terminales para aplicar en el sistema suspendido en lo techo con las puertas deslizantes traslapadas. Incluido los conectores para los tubos.

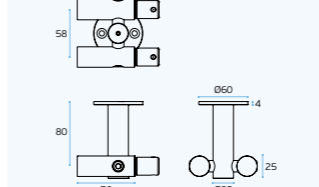
MATERIAL: EN 1.4301 AISI 304**IN.15.046**

Suporte ao tecto simples para aplicar sistema suspenso ao tecto e simultaneamente fixar a um painel de vidro fixo. Inclui um conector para os tubos / Simple ceiling support to apply suspended system to the ceiling and support one fixed glass at the same time. Includes one connector for the tubes / Soporte simple de techo para aplicar en el sistema suspendido en el techo y fijar al mismo tiempo un cristal fijo. Incluido un conector para los tubos.

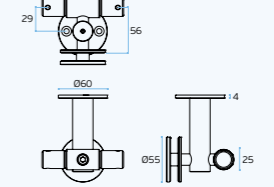
MATERIAL: EN 1.4301 AISI 304**IN.15.047**

Suporte ao tecto simples com terminal para aplicar sistema suspenso ao tecto e simultaneamente fixar a um painel de vidro fixo. Inclui um conector para os tubos / Simple ceiling support with terminal to apply suspended system to the ceiling and support one fixed glass at the same time. Includes one connector for the tubes / Soporte simple de techo con terminal para aplicar en el sistema suspendido en lo techo y fijar al mismo tiempo un cristal fijo. Incluido un conector para los tubos.

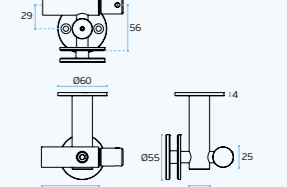
MATERIAL: EN 1.4301 AISI 304

A

Acessórios portas de correr Ø25mm /
Accessories for sliding door systems Ø25mm /
Accesorios para sistemas de puerta correderas Ø25mm.



IN.15.040
Prolongador para aplicar com IN.15.011. Afasta o tubo da parede +5mm /
Protractor to use with IN.15.011. Increase 5mm the offset between the wall and the tube / Prolongador para aplicar con IN.15.011. Aleja el tubo de la pared +5mm.

MATERIAL: EN 1.4301 AISI 304

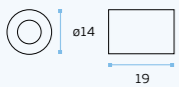

IN.15.028
Suporte de parede para utilizar quando o sistema intersecta perpendicularmente uma parede /
Wall connection sleeve to use when the system intersects perpendicularly a wall / Conexión de pared para usar cuando el sistema intersesta perpendicular una pared.

MATERIAL: EN 1.4301 AISI 304



IN.15.029
Suporte de vidro para utilizar quando o sistema intersecta perpendicularmente um vidro fixo /
Glass connection sleeve to use when the system intersects perpendicularly the glass / Conexión de cristal para usar cuando el sistema intersesta perpendicular un cristal fijo.

MATERIAL: EN 1.4301 AISI 304

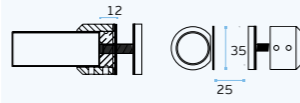

IN.15.017
Fixação para vidro. Para instalar com IN.15.011 e IN.15.012 /
Glass support. To install with IN.15.011 e IN.15.012 / Soporte para cristal. Para instalar con IN.15.011 e IN.15.012.

MATERIAL: EN 1.4301 AISI 304

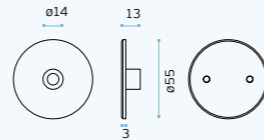

IN.15.020
Guia de chão para portas de vidro. Ajustável para vidro de 8 a 12mm /
Floor guide for glass doors. For glass with 8 to 12mm / Guia de suelo para puertas de cristal. Ajustable para cristal de 8 a 12mm.

MATERIAL: EN 1.4301 AISI 304

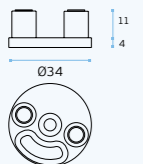

IN.15.019
Guia de chão para portas de vidro. Ajustável para vidro de 8 a 12mm /
Floor guide for glass doors. For glass with 8 to 12mm / Guia de suelo para puertas de cristal. Ajustable para cristal de 8 a 12mm.

MATERIAL: EN 1.4301 AISI 304

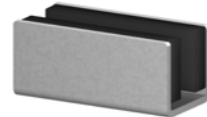
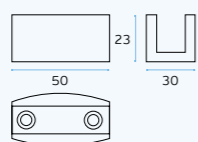

IN.15.023
Guia de chão para portas de vidro. Ajustável para vidro de 8 a 12mm /
Floor guide for glass doors. For glass with 8 to 12mm / Guia de suelo para puertas de cristal. Ajustable para cristal de 8 a 12mm.

MATERIAL: EN 1.4301 AISI 304

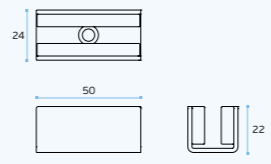

IN.15.150
Pino de segurança. Para instalar com IN.15.007 /
Security pin. To install with IN.15.007 / Pino de seguridad. Para instalar con IN.15.007.

MATERIAL: EN 1.4301 AISI 304

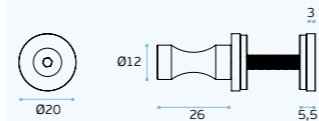

IN.15.039
Batente para porta de correr Ø25mm /
Stopper for sliding doors Ø25mm / Freno para puertas correderas Ø25mm.

MATERIAL: EN 1.4301 AISI 304

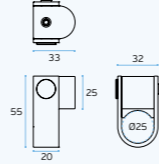

IN.15.038
Batente para porta de correr Ø25mm /
Stopper for sliding doors Ø25mm / Freno para puertas correderas Ø25mm.

MATERIAL: EN 1.4301 AISI 304

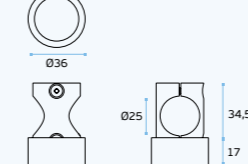

IN.15.004.C
Ferramenta para instalação de sistemas de portas de correr em aço inoxidável AISI 304 /

Tool for installing sliding door systems in stainless steel AISI 304 /

Herramienta para instalar sistemas de puertas correderas en acero inoxidable AISI 304

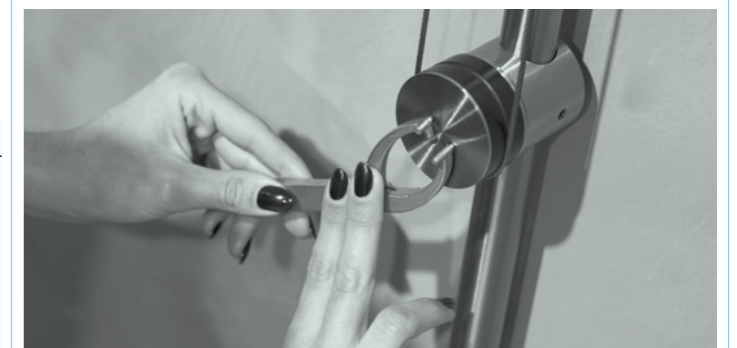

A

Acessórios portas de correr Ø25mm /
Accessories for sliding door systems Ø25mm /
Accesorios para sistemas de puerta correderas Ø25mm.

SOLID BAR Ø25mm

**BARRA MACIÇA Ø25mm PARA PORTAS DE
CORRER COM PESOS ATÉ 200Kg.**

SOLID BAR Ø25MM FOR SLIDING DOORS
WEIGHING UP TO 200KG.

BARRA MACIZA DE Ø25MM PARA PUERTAS
CORREDERAS HASTA 200KG DE PESO.

IN.15.034

Barra maciça para medidas especiais aplicável a qualquer suporte de parede ou tecto. Esta peça deverá ser encomendada com a medida exacta e os pontos de suporte deverão ser especificados. Bases e parafusos não incluídos. Peso máximo da porta de 200 kg / Solid tube for special dimensions applicable to any support wall or ceiling. This piece should be ordered with exact dimension number and position of the support points should be specified. Bases and screws not included. Maximum door weight of 200 kg / Tubo macizo para medidas especiales aplicable a cualquier tipo de apoyo pared o techo. Esta pieza debe ser pedida con las medidas exactas y los puntos de apoyo deberán ser especificados. Bases y tornillos no incluidos. Peso máximo de la puerta 200 kg.



IN.15.034.2

Suporte de parede para barra maciça: IN.15.034 /
Wall support to use with solid tube: IN.15.034 /
Soporte de pared para utilizar con tubo macizo: IN.15.034.

MATERIAL: EN 1.4301 AISI 304



IN.15.034.3

União para barra maciça: IN.15.034 /
Connection for solid tube: IN.15.034 /
Conexión para tubo macizo: IN.15.034.

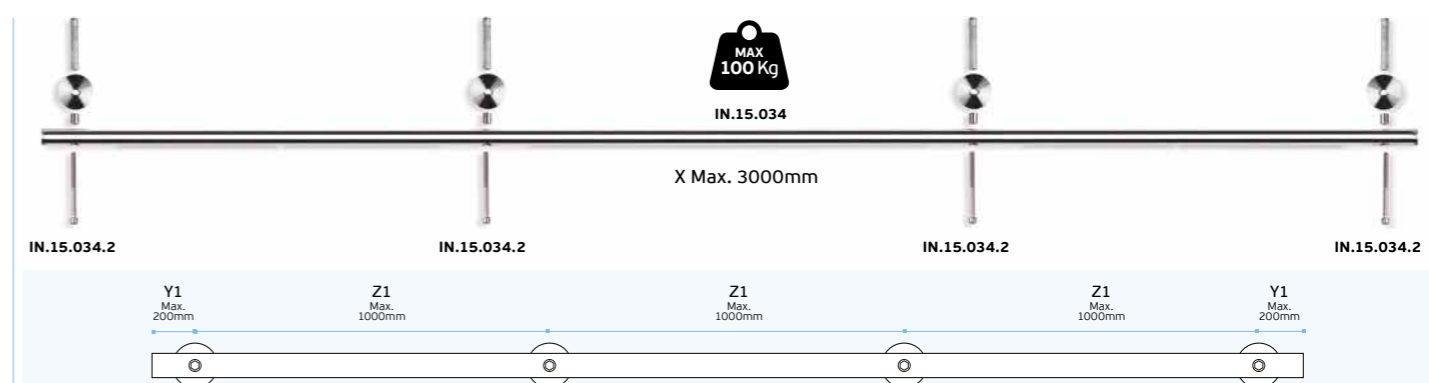
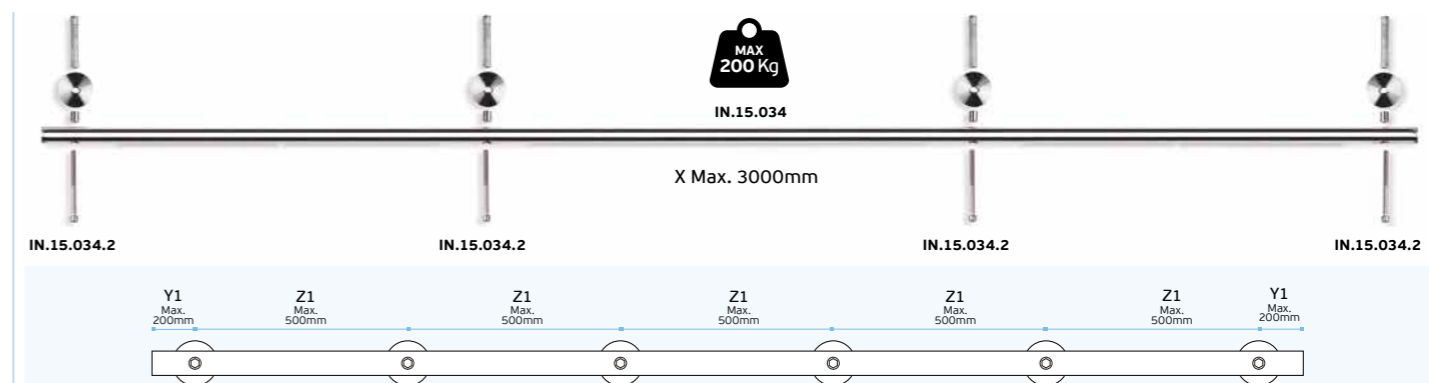

SISTEMA COMPLETO PARA PORTAS DE CORRER (Ø20MM)
 COMPLETE SYSTEM FOR SLIDING DOORS (Ø20MM)
 SISTEMA COMPLETO PARA PUERTAS CORREDERAS (Ø20MM)



TEN SQUARE AND ROUND FOR GLASS

SISTEMA COMPLETO PARA PORTAS DE
 CORRER. CARRIL MACIÇO COM Ø20MM
 (PORTA NÃO INCLUÍDA).

COMPLETE SLIDING DOORS SYSTEM.
 RAIL Ø20MM SOLID BAR
 (DOOR NOT INCLUDED).

SISTEMA COMPLETO PARA PUERTAS
 CORREDERAS.
 CARRIL Ø20MM BARRA SÓLIDA
 (PUERTA NO INCLUIDA).

TEN SQUARE FOR GLASS

SISTEMA COMPLETO - PORTAS DE CORRER - Ø20mm
COMPLETE SYSTEM - SLIDING DOORS - Ø20mm
SISTEMA COMPLETO - PUERTAS CORREDERAS - Ø20mm

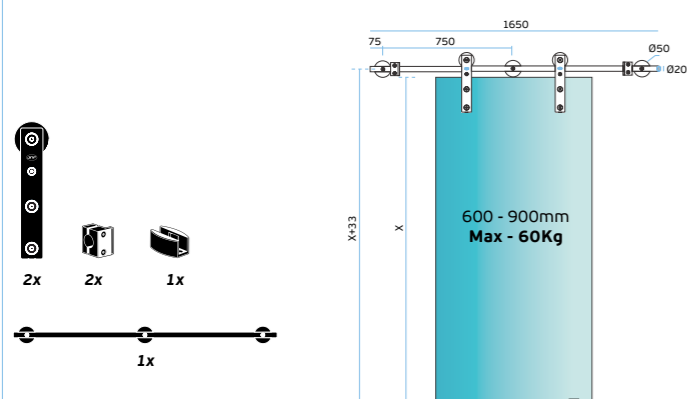

TEN SQUARE for glass

IN.15.120.K

Sistema completo para portas de correr em vidro (porta não incluída) / Complete system for glass sliding doors (door not included) / Sistema completo para puertas correderas en cristal (puerta no incluida).

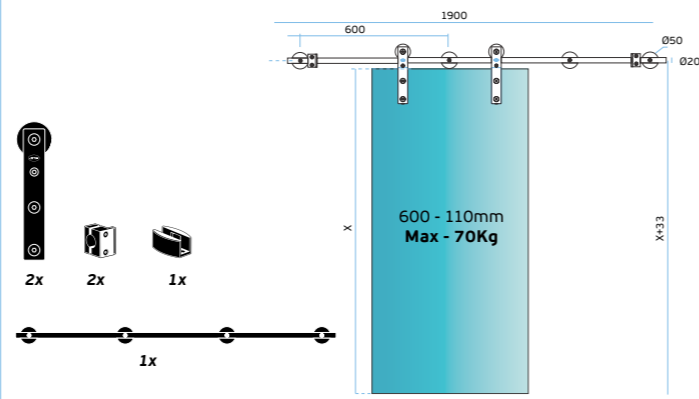
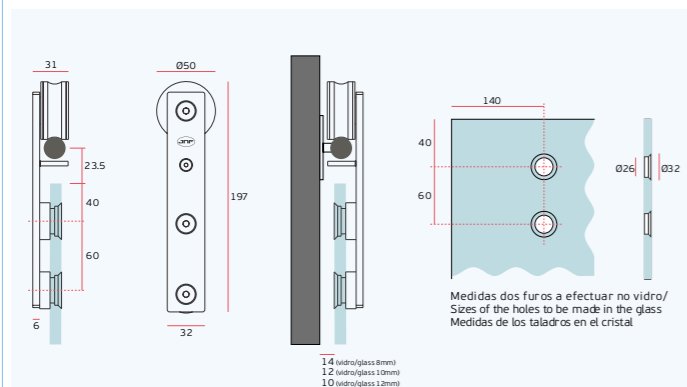

TEN SQUARE LARGE for glass

IN.15.120.K.L

Sistema completo para portas de correr em vidro (porta não incluída) / Complete system for glass sliding doors (door not included) / Sistema completo para puertas correderas en cristal (puerta no incluida).

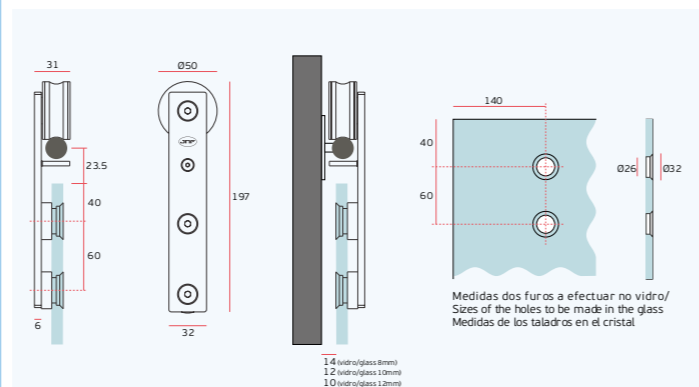

TEN ROUNDED FOR GLASS

SISTEMA COMPLETO - PORTAS DE CORRER - Ø20mm
COMPLETE SYSTEM - SLIDING DOORS - Ø20mm
SISTEMA COMPLETO - PUERTAS CORREDERAS - Ø20mm

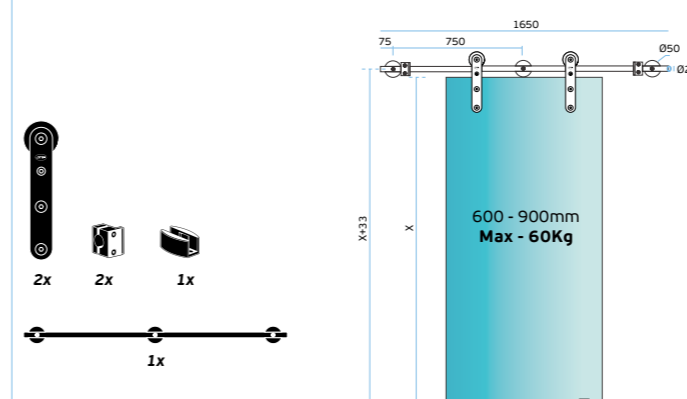

TEN ROUNDED for glass

IN.15.122.K

Sistema completo para portas de correr em vidro (porta não incluída) / Complete system for glass sliding doors (door not included) / Sistema completo para puertas correderas en cristal (puerta no incluida).

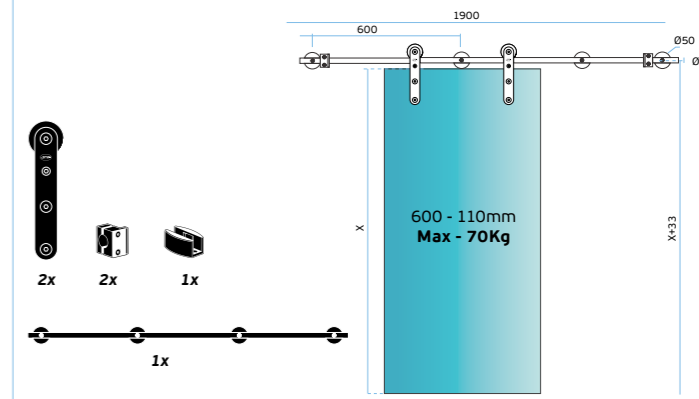
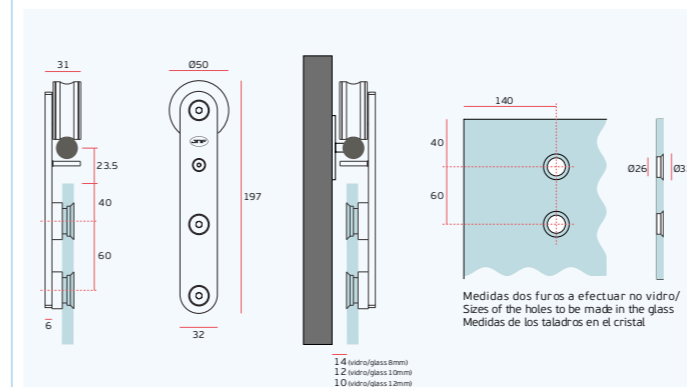

TEN ROUNDED LARGE for glass

IN.15.122.K.L

Sistema modular completo para portas de correr em vidro (porta não incluída) / Complete modular system for glass sliding doors (door not included) / Sistema modular completo para puertas correderas en cristal (puerta no incluida).

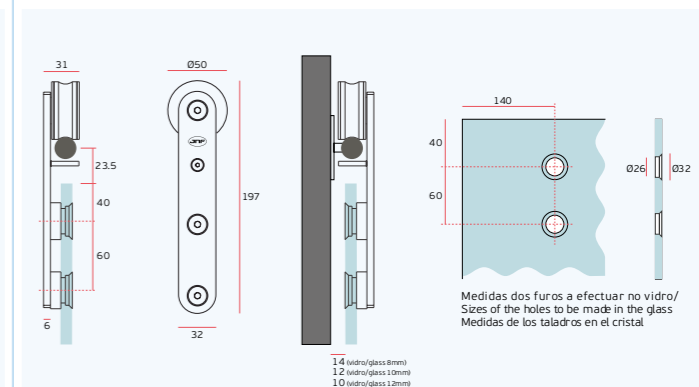

SISTEMA PARA PORTAS DE CORRER DE PAVIMENTO
SLIDING DOORS SYSTEM ON THE FLOOR
SISTEMA PARA PUERTAS CORREDERAS DE PAVIMENTO

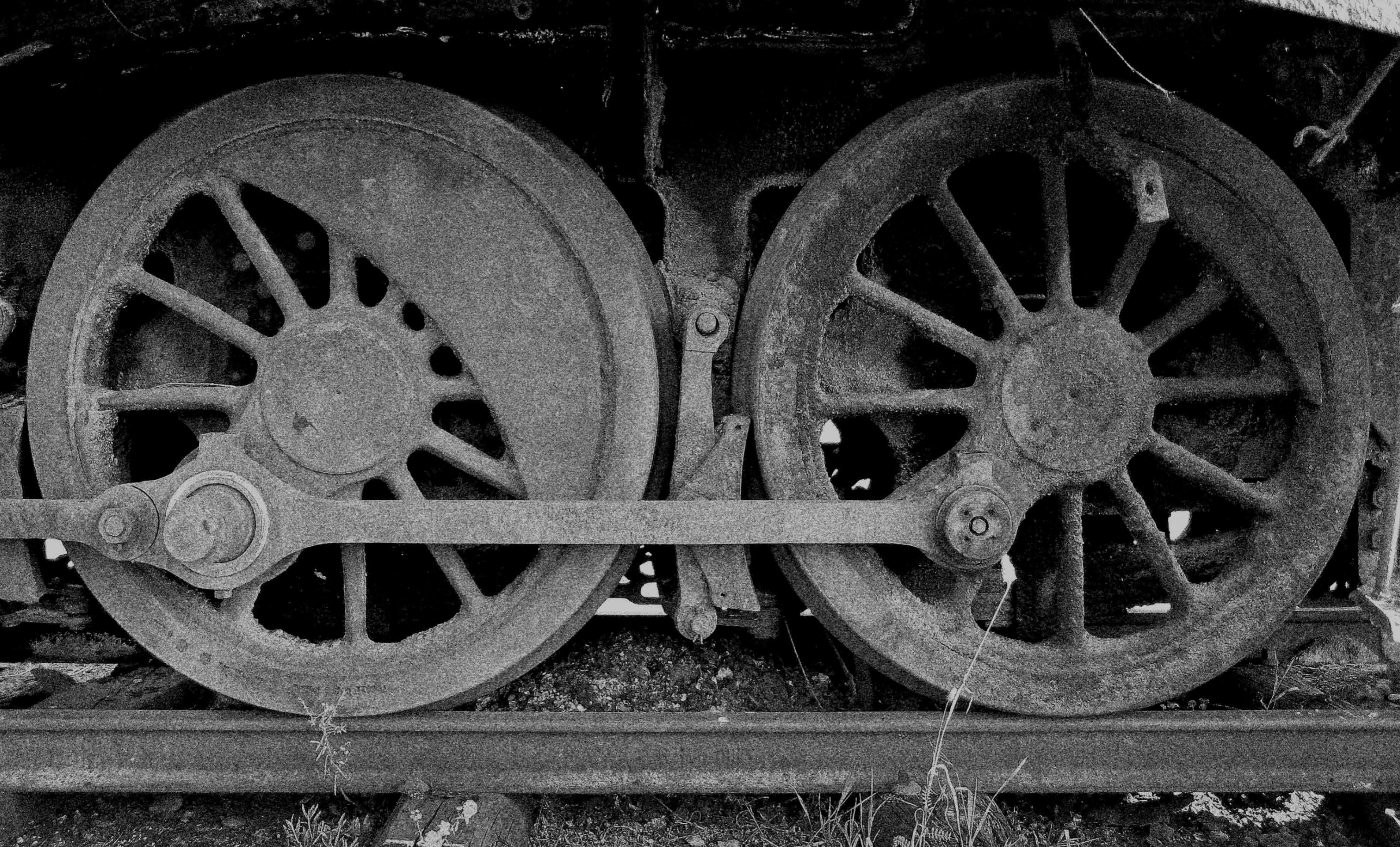

SISTEMA PARA PORTAS DE CORRER DE PAVIMENTO

SLIDING DOORS SYSTEM ON THE FLOOR

SISTEMA PARA PUERTAS CORREDERAS DE PAVIMENTO



MOVIE SOFT On floor for glass



EN1527 - 63-14-13



IN.15.301
 Material: EN 1.4301
 2x Roldanas
 Peso máx de porta 80 Kg
 Espessura de vidro 10 - 12 mm

Material: EN 1.4301
 2x wheels / Ruedas
 Max. load / Peso max. 80 Kg
 Glass Thickness / Espesor del cristal : 10 - 12mm

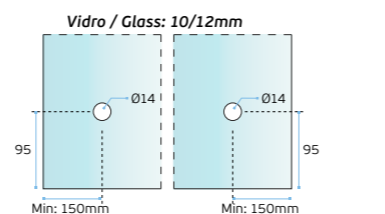

- 1x IN.15.301 / Roldanas / Wheels / Ruedas.
- 1x IN.15.071 / Cobertura / Cover / Cubierta.
- 1x IN.15.075.S / Coberturas laterais / Side covers / Cubierta laterales.
- 1x IN.15.070 / Carril superior / Upper track / Carril superior
- 1x IN.15.077 / Carril inferior / Lower track / Carril inferior

- 1x IN.15.301 / Roldanas / Wheels / Ruedas.
- 2x IN.15.071 / Cobertura / Cover / Cubierta.
- 1x IN.15.075.D / Coberturas laterais / Side covers / Cubierta laterales.
- 1x IN.15.070 / Carril superior / Upper track / Carril superior
- 1x IN.15.077 / Carril inferior / Lower track / Carril inferior

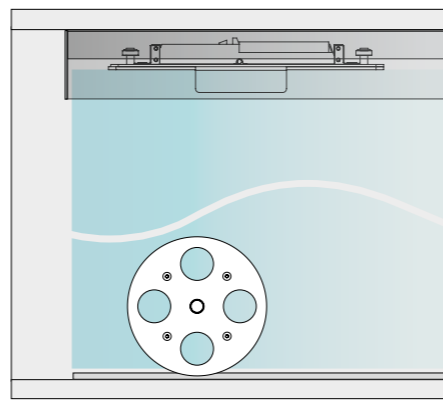
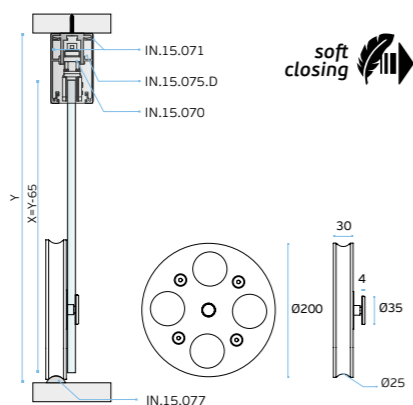
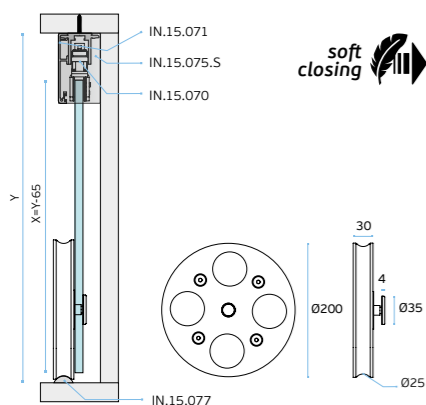

MOVIE On floor for glass

EN1527 - 63-14-13



IN.15.301
 Material: EN 1.4301
 2x Roldanas
 Peso máx de porta 120 Kg
 Espessura de vidro 10 - 12 mm

Material: EN 1.4301
 2x wheels / ruedas
 Max. load / peso max. 120 Kg
 Glass Thickness / Espesor del cristal : 10 - 12mm

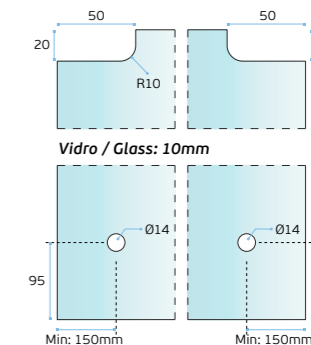

- 1x IN.15.301 / Roldanas / Wheels / Ruedas.
- 1x IN.15.078 / Carril superior / Upper track / Carril superior
- 1x IN.15.077 / Carril inferior / Lower track / Carril inferior

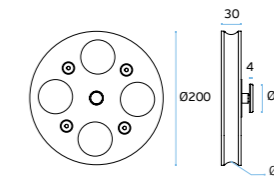
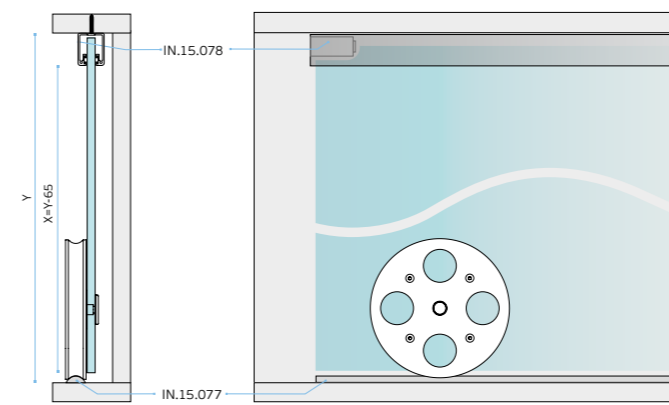

SISTEMA PARA PORTAS DE CORRER DE PAVIMENTO

SLIDING DOORS SYSTEM ON THE FLOOR

SISTEMA PARA PUERTAS CORREDERAS DE PAVIMENTO

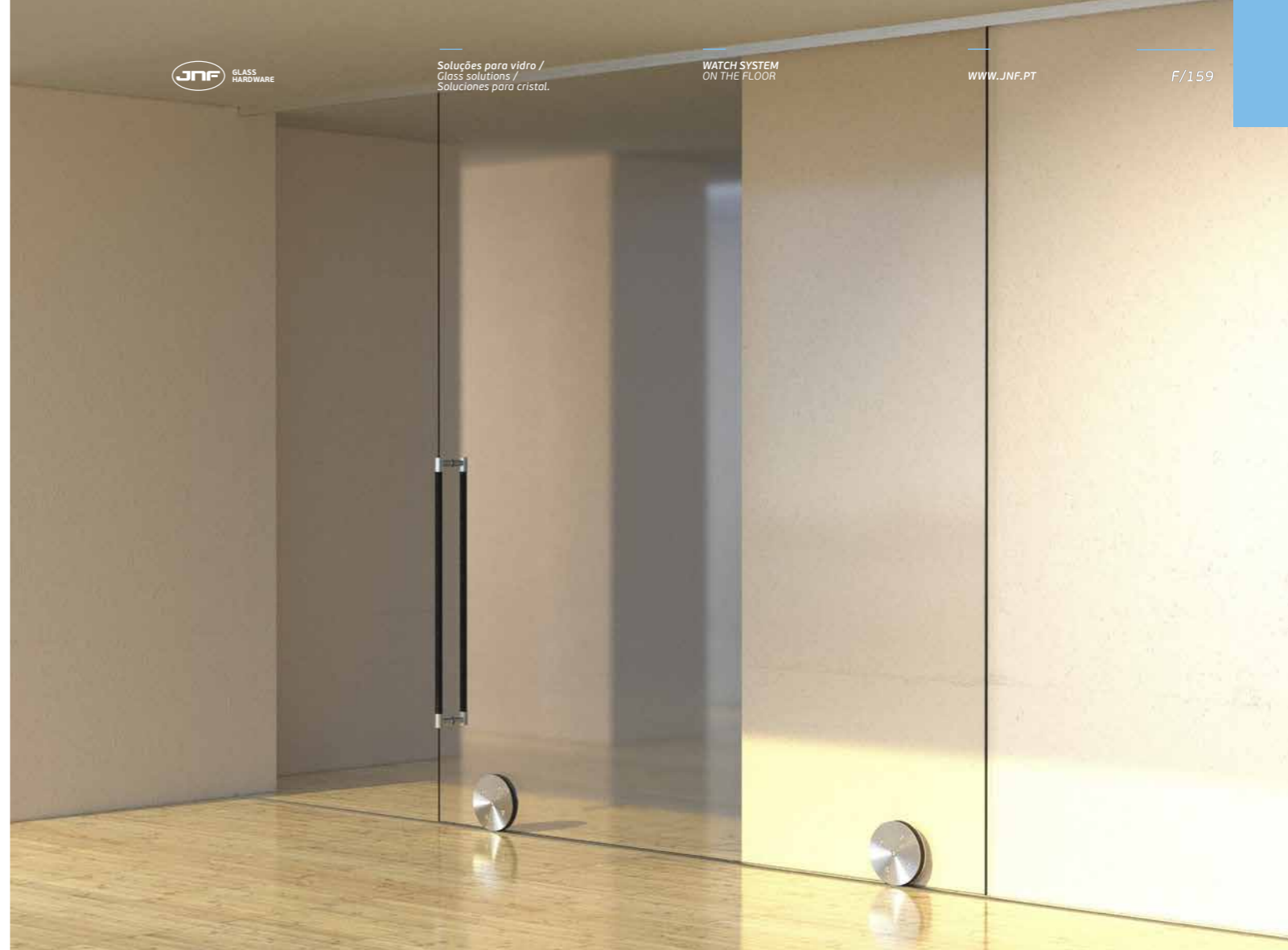

WATCH SOFT On floor for glass



EN1527 - 63-14-13



IN.15.300
Material: EN 1.4301
2x Roldanas
Peso máx de porta 80 Kg
Espessura de vidro 10 - 12 mm

Material: EN 1.4301
2x wheels / Ruedas
Max. load / Peso max. 80 Kg
Glass Thickness / Espesor del cristal : 10 - 12mm

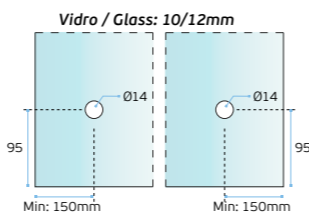

- 1x IN.15.300 / Roldanas / Wheels / Ruedas.
- 1x IN.15.071 / Cobertura / Cover / Cubierta.
- 1x IN.15.075.S / Coberturas laterais / Side covers / Cubierta laterales.
- 1x IN.15.070 / Carril superior / Upper track / Carril superior
- 1x IN.15.077 / Carril inferior / Lower track / Carril inferior

- 1x IN.15.300 / Roldanas / Wheels / Ruedas.
- 2x IN.15.071 / Cobertura / Cover / Cubierta.
- 1x IN.15.075.D / Coberturas laterais / Side covers / Cubierta laterales.
- 1x IN.15.070 / Carril superior / Upper track / Carril superior
- 1x IN.15.077 / Carril inferior / Lower track / Carril inferior

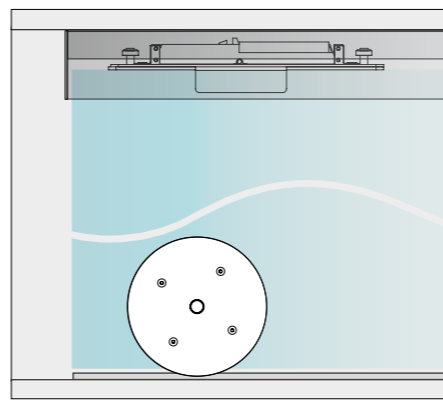
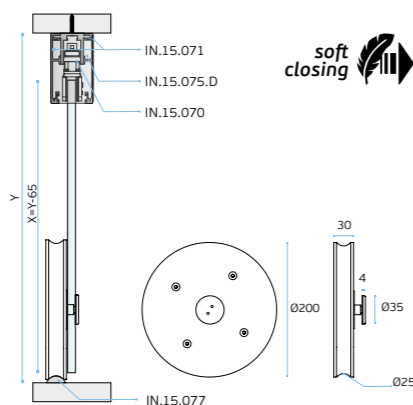
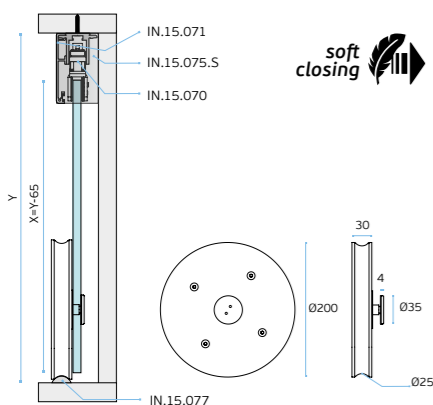

WATCH On floor for glass

EN1527 - 63-14-13



IN.15.300
Material: EN 1.4301
2x Roldanas
Peso máx de porta 120 Kg
Espessura de vidro 10 - 12 mm

Material: EN 1.4301
2x wheels / ruedas
Max. load / peso max. 120 Kg
Glass Thickness / Espesor del cristal : 10 - 12mm

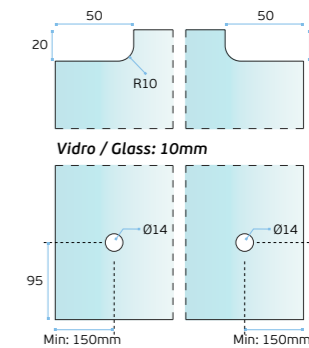

- 1x IN.15.300 / Roldanas / Wheels / Ruedas.
- 1x IN.15.078 / Carril superior / Upper track / Carril superior
- 1x IN.15.077 / Carril inferior / Lower track / Carril inferior

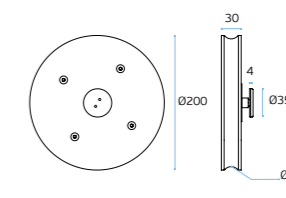
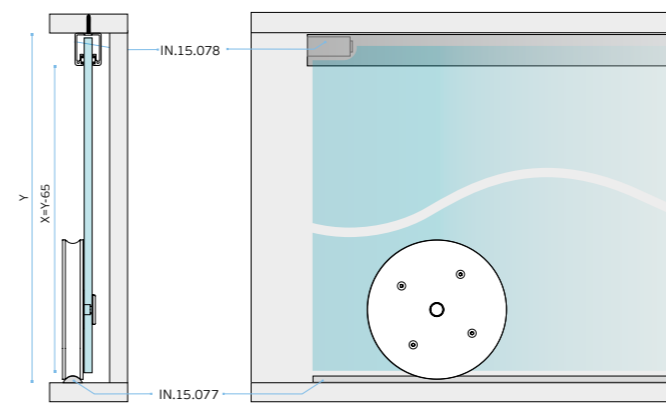

SISTEMA PARA PORTAS DE CORRER DE PAVIMENTO

SLIDING DOORS SYSTEM ON THE FLOOR

SISTEMA PARA PUERTAS CORREDERAS DE PAVIMENTO

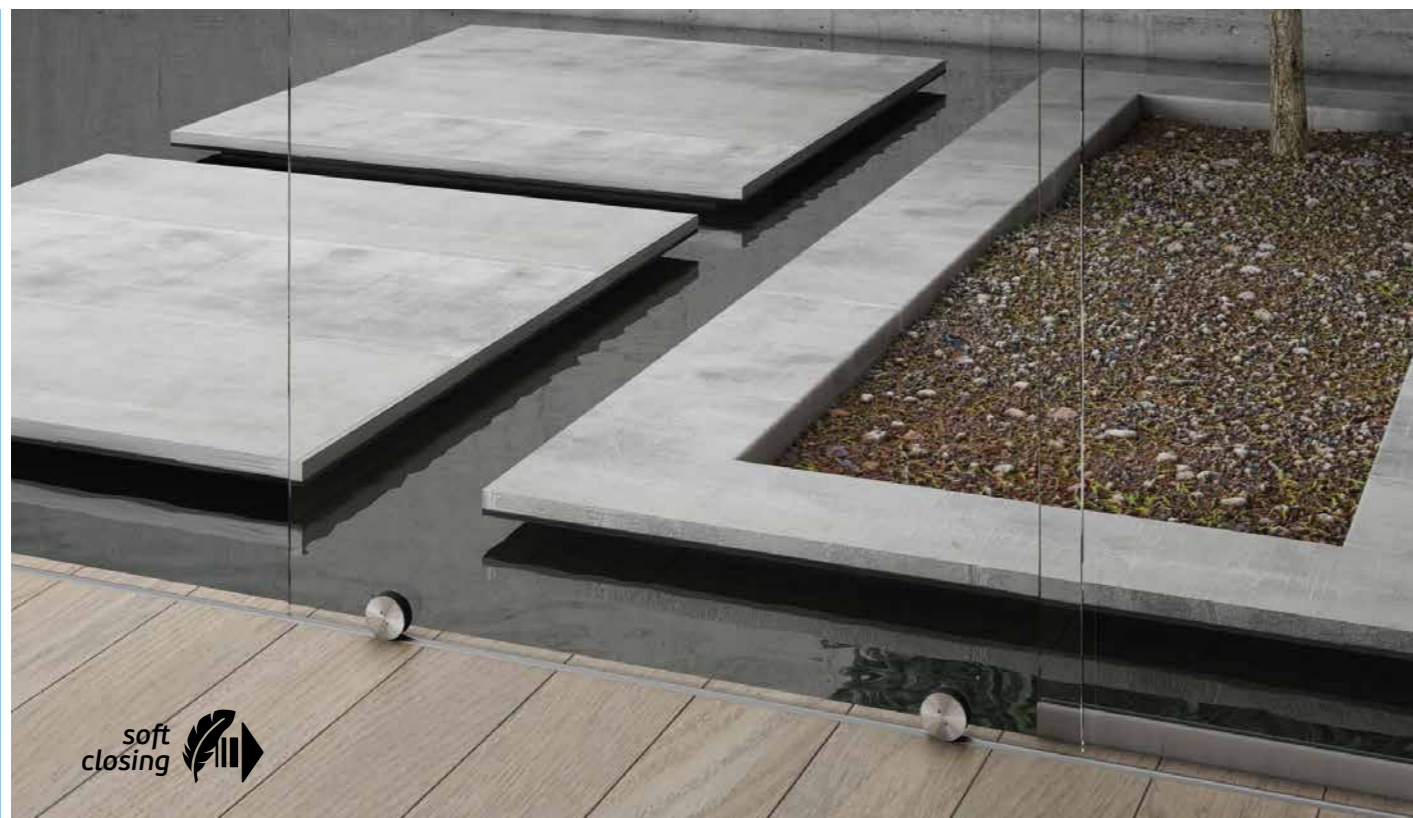

CLEAR SOFT On floor for glass



EN1527 - 62-14-13



IN.15.008
 Material: EN 1.4301
 2x Roldanas
 Peso máx de porta 120 Kg
 Espessura de vidro 10 - 12mm

Material: EN 1.4301
 2x wheels / Ruedas
 Max. load / Peso max. 120 Kg
 Glass thickness / Espesor del cristal : 10 - 12mm

- 1x IN.15.008 - Roldanas / Wheels / Ruedas.
- 1x IN.15.071 - Cobertura / Cover / Cubierta.
- 1x IN.15.075.S / Coberturas laterais / Side covers / Cubierta laterales.
- 1x IN.15.070 - Carril superior / Upper track / Carril superior
- 1x IN.15.077 - Carril inferior / Lower track / Carril inferior

- 1x IN.15.008 - Roldanas / Wheels / Ruedas.
- 2x IN.15.071 - Cobertura / Cover / Cubierta.
- 1x IN.15.075.D - Coberturas laterais / Side covers / Cubierta laterales.
- 1x IN.15.070 - Carril superior / Upper track / Carril superior
- 1x IN.15.077 - Carril inferior / Lower track / Carril inferior

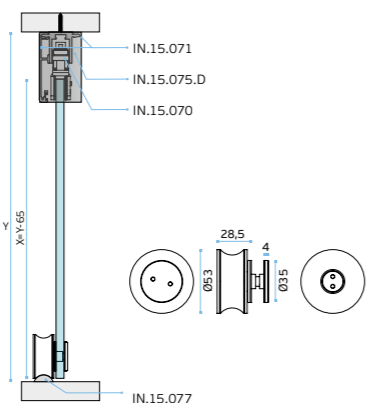
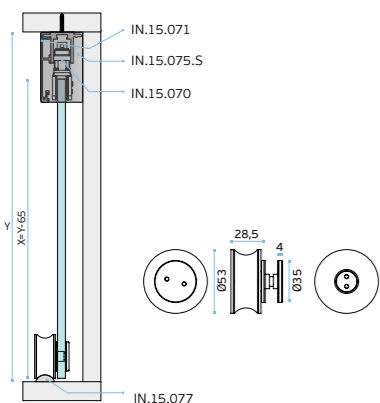
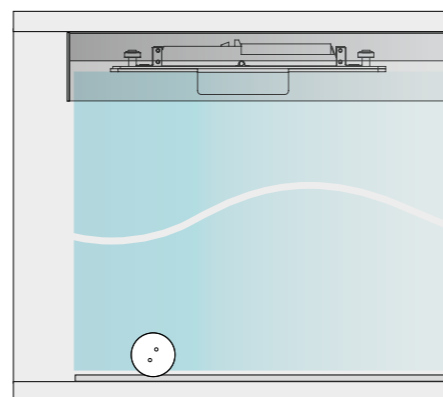
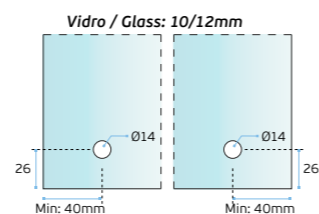

CLEAR On floor for glass

EN1527 - 63-14-13



IN.15.008
 Material: EN 1.4301
 2x Roldanas
 Peso máx de porta 120 Kg
 Espessura de vidro 10 - 12 mm

Material: EN 1.4301
 2x wheels /ruedas
 Max. load / peso max. 120 Kg
 Glass thickness / Espesor del cristal : 10 - 12mm

- 1x IN.15.008 - Roldanas / Wheels / Ruedas.
- 1x IN.15.078 - Carril superior / Upper track / Carril superior
- 1x IN.15.077 - Carril inferior / Lower track / Carril inferior

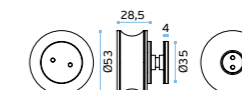
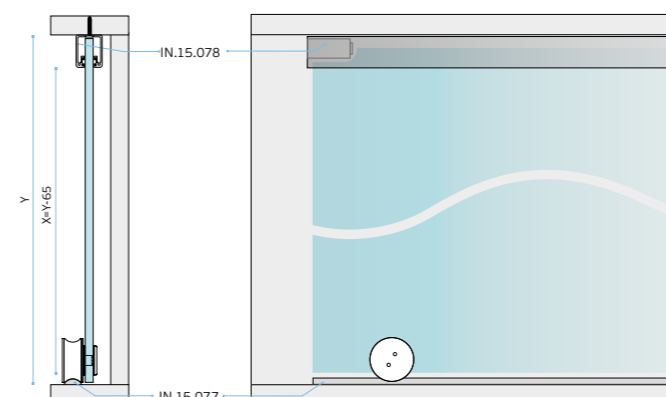
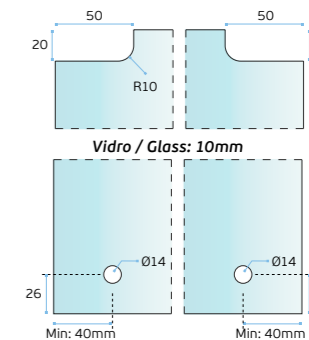

SISTEMA PARA PORTAS DE CORRER DE PAVIMENTO
 SLIDING DOORS SYSTEM ON THE FLOOR
 SISTEMA PARA PUERTAS CORREDERAS DE PAVIMENTO



FERROVIA SOFT On floor for glass



EN1527 - 62-14-13



IN.15.217
 Material: EN 1.4301 - Satinado / Satin
 2x Roldanas / Wheels / Ruedas
 Peso máx. porta / Max. load / Peso max.: 80Kg
 Espessura de vidro / Glass thickness /
 Espesor del cristal : 10 - 12mm

IN.15.217.P
 Material: EN 1.4301 - Polido / Polished / Polido
 2x Roldanas / Wheels / Ruedas
 Peso máx. porta / Max. load / Peso max.: 80Kg
 Espessura de vidro / Glass thickness /
 Espesor del cristal : 10 - 12mm

- 1x IN.15.217 - Roldanas / Wheels / Ruedas
- 1x IN.15.071 - Cobertura / Cover / Cubierta
- 1x IN.15.075.S - Coberturas laterais / Side covers / Cubierta laterales
- 1x IN.15.070 - Carril superior / Upper track / Carril superior
- 1x IN.15.077 - Carril inferior / Lower track / Carril inferior

- 1x IN.15.217 - Roldanas / Wheels / Ruedas
- 2x IN.15.071 - Cobertura / Cover / Cubierta
- 1x IN.15.075.D - Coberturas laterais / Side covers / Cubierta laterales
- 1x IN.15.070 - Carril superior / Upper track / Carril superior
- 1x IN.15.077 - Carril inferior / Lower track / Carril inferior

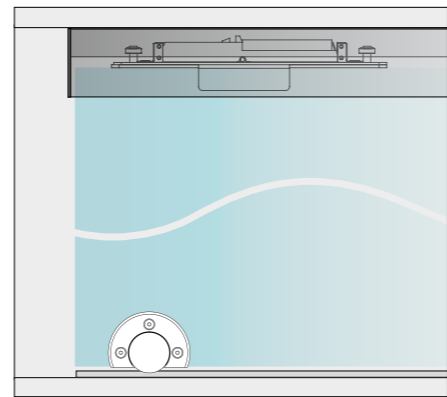
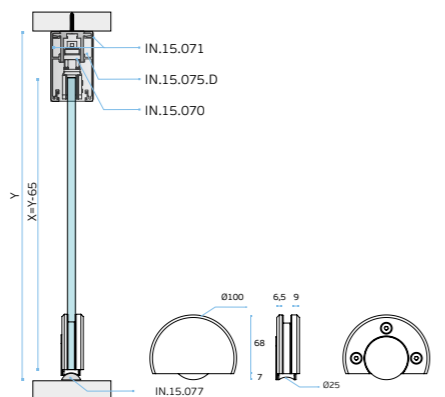
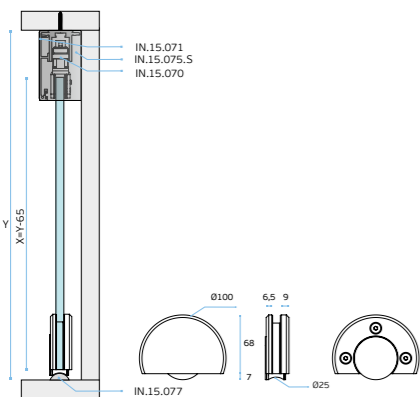
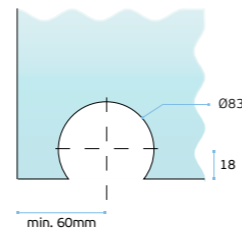

FERROVIA On floor for glass

EN1527 - 62-14-13



IN.15.217
 Material: EN 1.4301 - Satinado / Satin
 2x Roldanas / Wheels / Ruedas.
 Peso máx. porta / Max. load / Peso max.: 120Kg
 Espessura de vidro / Glass thickness /
 Espesor del cristal: 10 - 12mm

IN.15.217.P
 Material: EN 1.4301 - Polido / Polished / Polido
 2x Roldanas / Wheels / Ruedas.
 Peso máx. porta / Max. load / Peso max.: 120Kg
 Espessura de vidro / Glass thickness /
 Espesor del cristal: 10 - 12mm

- 1x IN.15.217 - Roldanas / Wheels / Ruedas
- 1x IN.15.078 - Carril superior / Upper track / Carril superior
- 1x IN.15.077 - Carril inferior / Lower track / Carril inferior

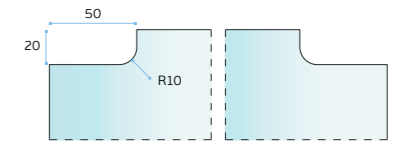

Vidro / Glass: 10mm

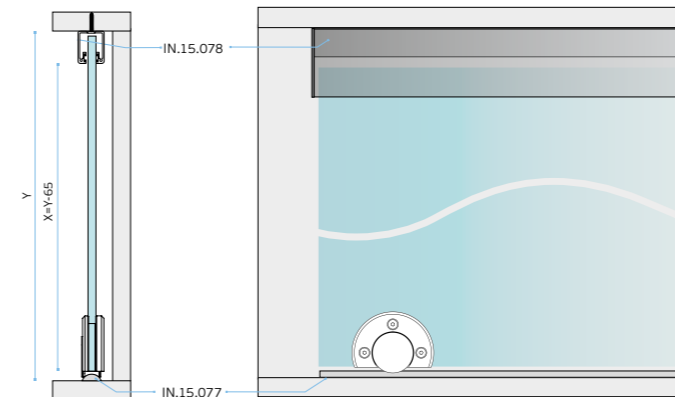
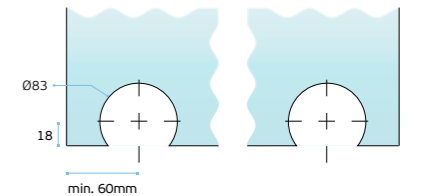

R 12.5mm



A



Acessórios portas de correr de pavimento /
Accessories for sliding door systems on the floor /
Accesorios para sistemas de puerta correderas de pavimento.

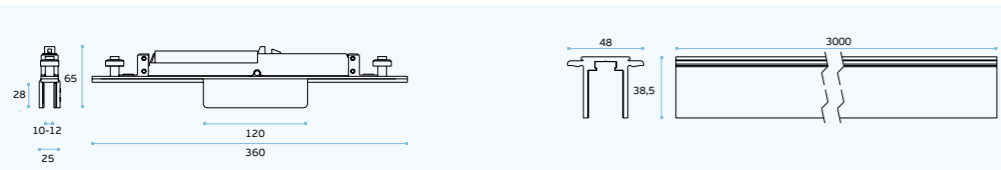

IN.15.070
Carril superior em alumínio com batentes e sistema de fecho suave. Para portas de vidro / Aluminium upper track with stoppers and soft closing system. For glass door /
Carril superior en aluminio con frenos y sistema de cierre suave. Para puertas de cristal.



80 kg





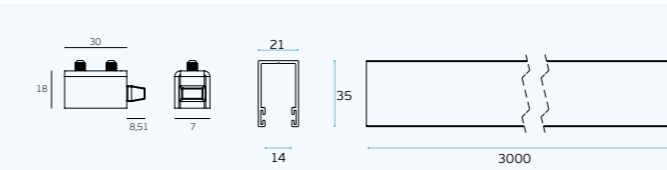
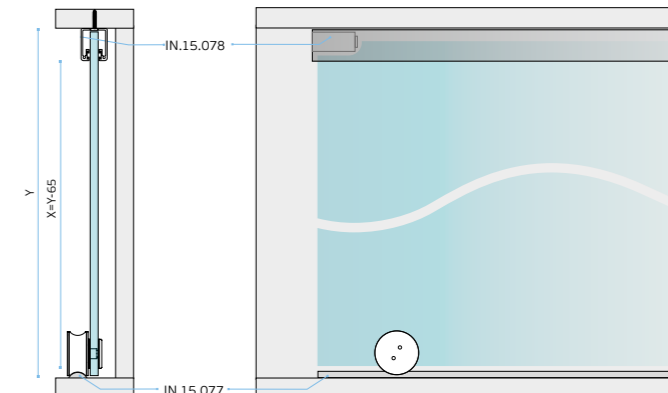

IN.15.078
Carril superior em alumínio com batentes Para vidro 10 mm. Aluminium upper track with stoppers. For 10 mm. glass
Carril superior en aluminio con frenos. Para cristal de 10 mm.





IN.15.071
Cobertura em alumínio cor inox para calha superior IN.15.070 / Aluminium upper cover for track IN.15.070 Stainless steel colour. /
Cubierta superior en aluminio color inox para o carril IN.15.070

IN.15.075.S
Tampas de topo para calhas de aplicação à parede / End covers for wall rail application /
Tapas para aplicación del carril en parede.

IN.15.075.D
Tampas de topo para calhas de aplicação ao tecto / End covers for ceiling rail application /
Tapas para aplicación del carril en techo.



IN.15.077
Carril inferior em aço inox Stainless steel lower track
Carril inferior en acero inoxidable (3000mm)

IN.15.077.B
Carril inferior em aço inox Stainless steel lower track
Carril inferior en acero inoxidable (6000mm)



SOLUÇÕES DE FERRAGENS PARA PORTAS DE FOLE E PARQUE /
GLASS HARDWARE SOLUTIONS FOR FOLDING & PARK DOORS /
SOLUCIONES DE HERRAJES PARA PUERTAS PLEGABLES Y DE PARQUE

FOLDING SYSTEM FOR GLASS

SISTEMA DE PORTAS DE FOLE EM VIDRO
PARA COMPARTIMENTAÇÃO DE ESPAÇOS /
GLASS FOLDING DOOR SYSTEM
FOR SPACE COMPARTMENT /
SISTEMA DE PUERTAS PLEGABLES
CRISTAL PARA COMPARTIMENTO DE ESPACIO

SOLUÇÕES DE FERRAGENS PARA PORTAS DE FOLE E PARQUE / GLASS HARDWARE SOLUTIONS FOR FOLDING & PARK DOORS / SOLUCIONES DE HERRAJES PARA PUERTAS PLEGABLES Y DE PARQUE

O sistema de portas de fole com painéis de vidro e ferragens de aço inoxidável é uma adição simples e moderna a qualquer espaço, além da simplicidade também oferece benefícios práticos, como compartimentação dos espaços.

Os painéis de vidro permitem que a luz natural flua, criando uma atmosfera aberta e convidativa. As ferragens de aço inoxidável adicionam durabilidade.

O sistema de fole economiza espaço, tornando-se uma ótima opção em áreas onde precisamos de grandes vãos de abertura.

Uma das maiores vantagens das portas de fole é a capacidade de criar compartimentos separados dentro de um espaço maior.

Folding doors system with glass panels and stainless steel hardware are a sleek and modern addition to any space. Not only do they look great, but they also offer practical benefits such as compartmentation.

Glass panels allow for natural light to flow through, creating an open and inviting atmosphere. The stainless steel hardware adds durability and a stylish touch. The folding design of the doors saves space, making them a great option balconies or areas where we need big openings.

One of the greatest advantages of folding doors is the ability to create separate compartments within a larger space.

El sistema de puertas plegables con paneles de cristal y herrajes de acero inoxidable es una adición simple y moderna a cualquier espacio, y además de la simplicidad también ofrece beneficios prácticos como la compartimentación de espacios.

Los paneles de cristal permiten que fluya la luz natural, creando un ambiente abierto y acogedor. Los herrajes de acero inoxidable agregan durabilidad.

El sistema de fuelle ahorra espacio, por lo que es una excelente opción en áreas donde necesitamos grandes aberturas.

Una de las mayores ventajas de las puertas plegables es la capacidad de crear compartimentos separados dentro de un espacio más grande.

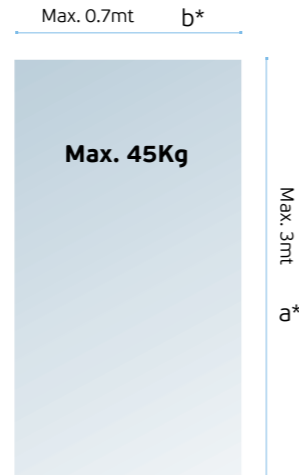

*medida em metros /
*measure in meters /
*medida en metros /

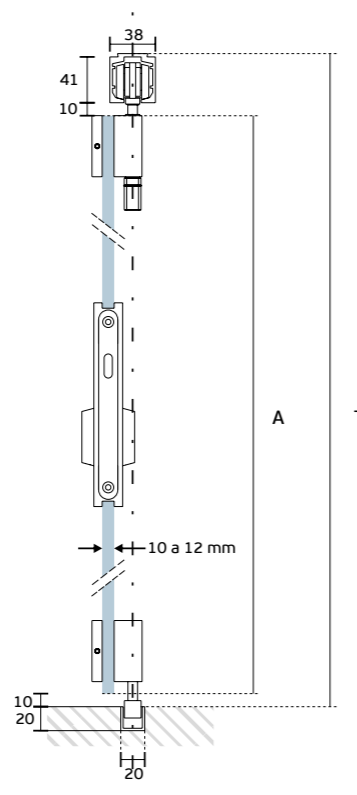
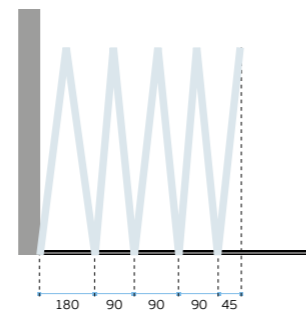

Fórmula para calcular altura das portas. /

Formula to calculate the height of the doors / Formula para calcular la altura de las puertas.

$$A = T - 61$$

A = Altura das portas /
height of doors /
Altura de puertas.

T = Altura total /
Height glass door /
Altura puerta cristal.

Peso / Weight =

$$2,5 \times 10 \times (2,2 \times 0,7) = 38,5 \text{ Kg}$$

a*	2,2
b*	0,7

Tabela de peso do vidro temperado /
Table of weight for tempered glass /
Cuadro de peso de cristal templado.

Espessura do vidro / Thickness of the glass / Tabla de peso de cristal:	Kg / m ²
10mm	25,00 Kg
12mm	30,00 Kg

Cálculo do peso da porta de vidro (em Kg) / Calculate the weight of the door glass (in Kg) / Calcular el peso de la puerta de cristal (en Kg).

FOLDING SYSTEM FOR GLASS

O SISTEMA DE FOLE ECONOMIZA ESPAÇO, TORNANDO-SE UMA ÓTIMA OPÇÃO EM ÁREAS ONDE PRECISAMOS DE GRANDES VÃOS DE ABERTURA /
THE FOLDING SYSTEM SAVES SPACE, MAKING IT A GREAT OPTION IN AREAS WHERE LARGE OPENINGS ARE NEEDED /
EL SISTEMA DE FUELLE AHORRA ESPACIO, LO QUE LO CONVIERTE EN UNA EXCELENTE OPCIÓN EN ÁREAS DONDE SE NECESITAN GRANDES ABERTURAS.

SOLUÇÕES DE FERRAGENS PARA PORTAS DE FOLE E PARQUE / GLASS HARDWARE SOLUTIONS FOR FOLDING & PARK DOORS / SOLUCIONES DE HERRAJES PARA PUERTAS PLEGABLES Y DE PARQUE

PORTAS PARES /
Esquema de aplicação com portas pares. Em portas com altura superior a 2300m aconselha-se a utilização de dobradiças intermédias /

PAIRS DOORS /
Application scheme with pairs doors. For doors with more than 2300mm height we advise the use of intermediate hinges /

PUERTAS PARES.
Plan de aplicación con puertas pares. Puertas más altas que 2300mm es necesario el uso de bisagras intermedias.

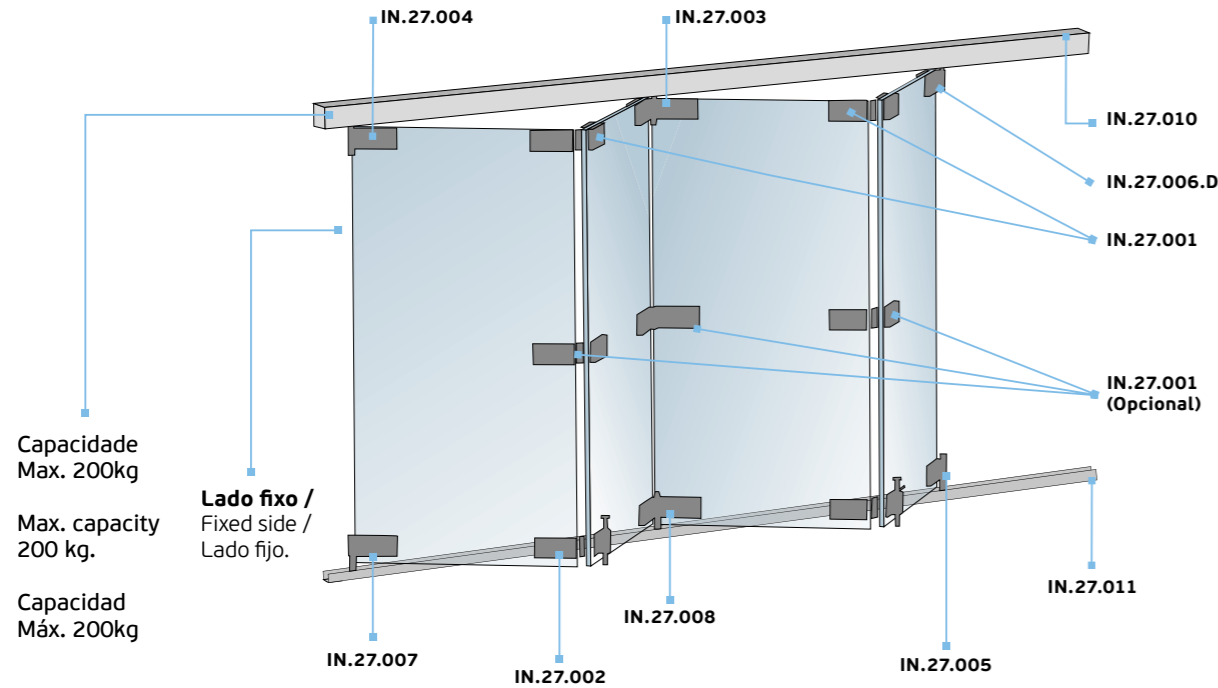

Capacidade Max. 200kg
Max. capacity 200 kg.
Capacidad Máx. 200kg

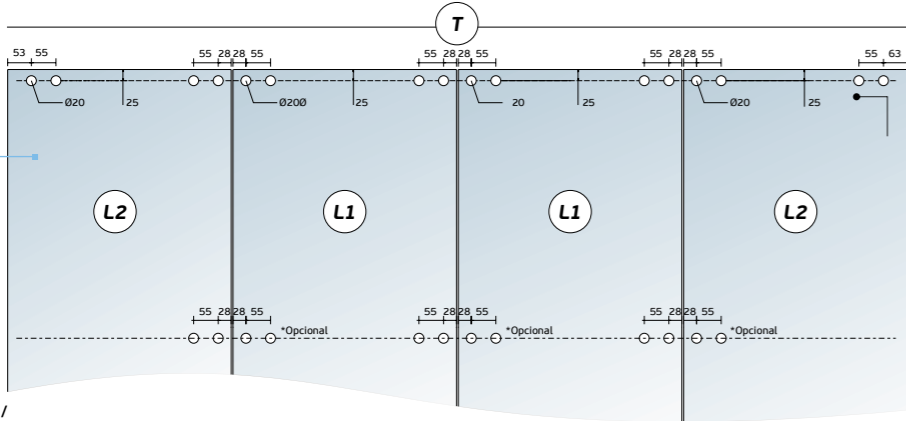
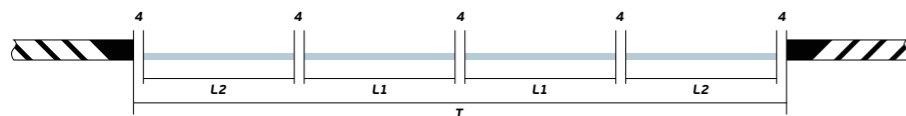

Lado fixo / Fixed side / Lado fijo.

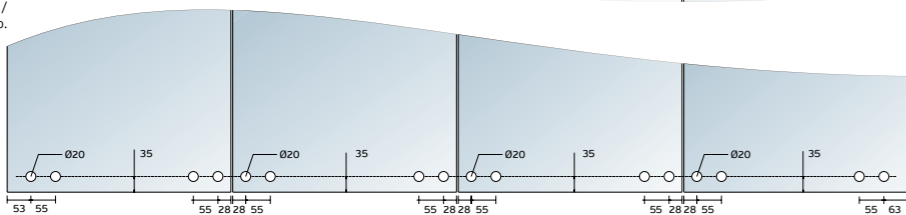

Fórmula para calcular largura das portas /
Formula to calculate the door widths /
Formula para calcular la anchura de las puertas.

$$L1 = \frac{T-44}{P} - 4$$

$$L2 = L1 + 20$$

P = Número de portas /
Number of doors /
Numero de puertas
T = Largura total /
Total wide / Anchura total.
L1 = Largura porta de vidro /
Wide glass door /
Anchura puerta cristal.

***Em portas com altura superior a 2300mm aconselha-se a utilização de dobradiças intermédias. /**
*For doors with more than 2300mm height we advise the use of intermediate hinges
*Para las puertas con una altura superior a 2300mm aconseja el uso de bisagras intermedias.

PORTAS ÍMPARES /
Esquema de aplicação com portas ímpares. Em portas com altura superior a 2300m aconselha-se a utilização de dobradiças intermédias. /

ODD DOORS /
Application scheme with odd doors. For doors with more than 2300mm height we advise the use of intermediate hinges /

PUERTAS IMPARES
Plan de aplicación con puertas impares. Puertas más altas que 2300mm es necesario el uso de bisagras intermedias.

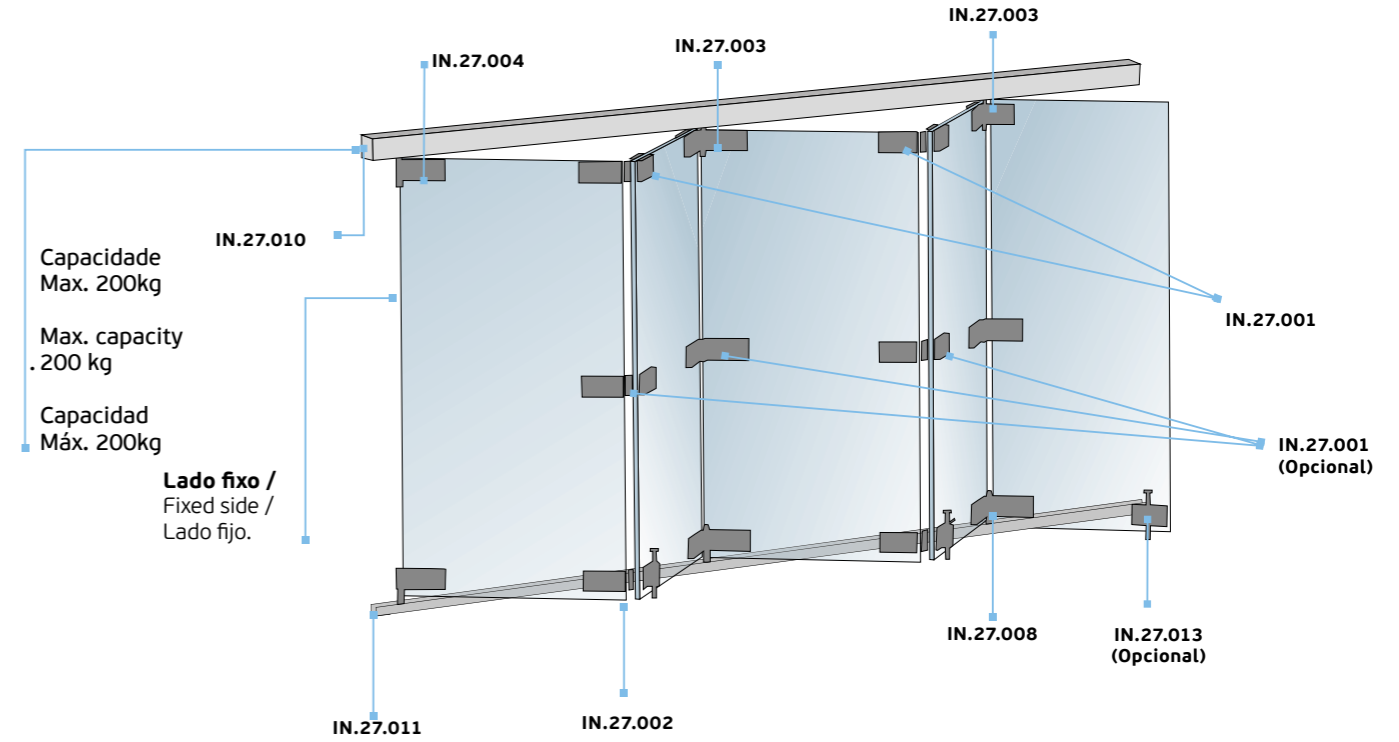

Capacidade Max. 200kg
Max. capacity 200 kg
Capacidad Máx. 200kg

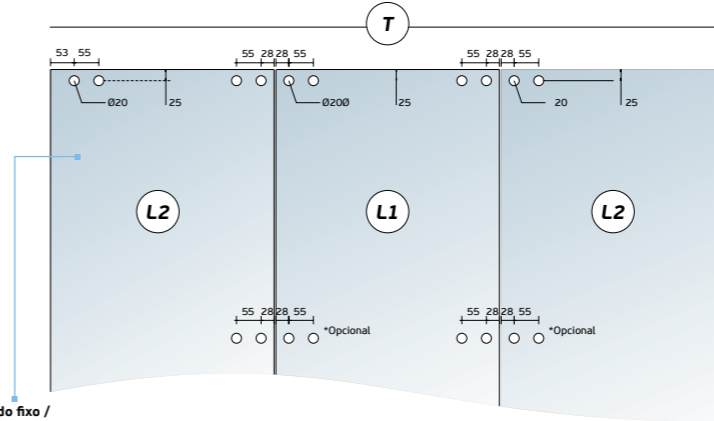
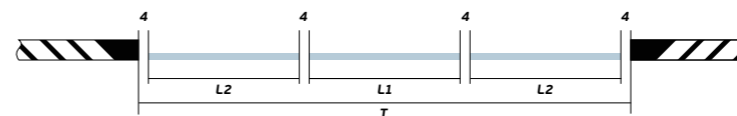

Lado fixo / Fixed side / Lado fijo.

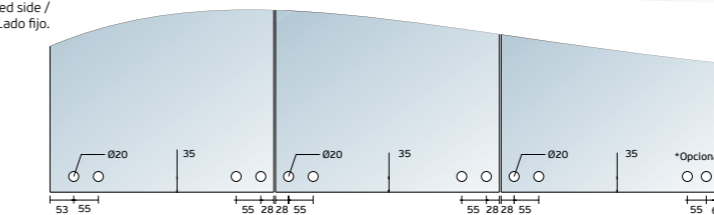

Fórmula para calcular largura das portas /
Formula to calculate the door widths /
Formula para calcular la anchura de las puertas.

$$L1 = \frac{T-44}{P} - 4$$

$$L2 = L1 + 20$$

P = Número de portas /
Number of doors /
Numero de puertas
T = Largura total /
Total wide / Anchura total.
L1 = Largura porta de vidro /
Wide glass door /
Anchura puerta cristal.

***Em portas com altura superior a 2300mm aconselha-se a utilização de dobradiças intermédias. /**
*For doors with more than 2300mm height we advise the use of intermediate hinges
*Para las puertas con una altura superior a 2300mm aconseja el uso de bisagras intermedias.

SOLUÇÕES DE FERRAGENS PARA PORTAS DE FOLE E PARQUE / GLASS HARDWARE SOLUTIONS FOR FOLDING & PARK DOORS / SOLUCIONES DE HERRAJES PARA PUERTAS PLEGABLES Y DE PARQUE



IN.27.006.D
Pivot superior /
Upper pivot / Pivote superior.

MATERIAL: EN 1.4301 / AISI 304

ACABAMENTO / FINISH / ACABADO: STANDARD: SATINADO / SATIN / SATIN

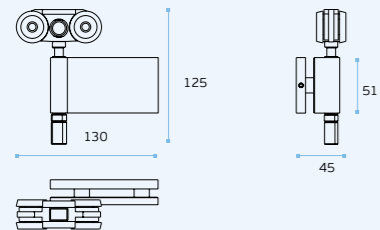

IN.27.003
Dobradiça superior (pivot) /
Upper hinge (pivot) / Bisagra superior (pivote).

MATERIAL: EN 1.4301 / AISI 304

ACABAMENTO / FINISH / ACABADO: STANDARD: SATINADO / SATIN / SATIN

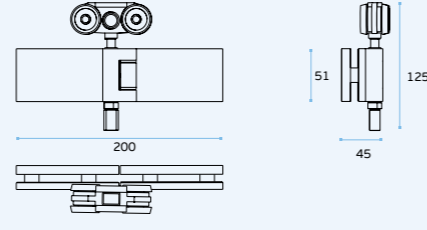

IN.27.004
Pivot superior (fixo) /
Upper pivot (fixed) / Pivote superior (fijo).

MATERIAL: EN 1.4301 / AISI 304

ACABAMENTO / FINISH / ACABADO: STANDARD: SATINADO / SATIN / SATIN

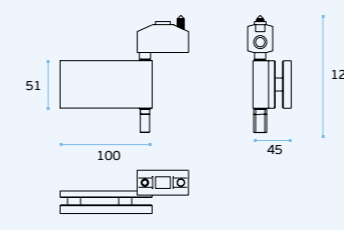

IN.27.001
Dobradiça superior. Dobradiça intermédia (opcional) /
Upper hinge. Middle hinge (optional) /
Bisagra superior. Bisagra intermedia (opcional).

MATERIAL: EN 1.4301 / AISI 304

ACABAMENTO / FINISH / ACABADO: STANDARD: SATINADO / SATIN / SATIN

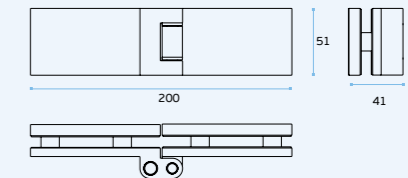

IN.27.005
Pivot inferior /
Lower pivot / Pivote inferior.

MATERIAL: EN 1.4301 / AISI 304

ACABAMENTO / FINISH / ACABADO: STANDARD: SATINADO / SATIN / SATIN

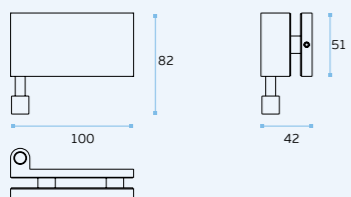

IN.27.008
Dobradiça inferior (pivot) /
Lower hinge (pivot) / Bisagra inferior (pivote).

MATERIAL: EN 1.4301 / AISI 304

ACABAMENTO / FINISH / ACABADO: STANDARD: SATINADO / SATIN / SATIN

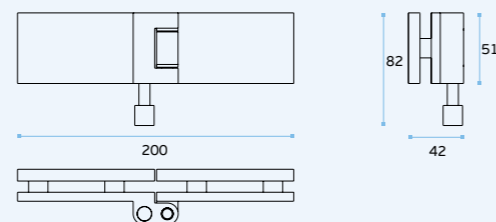

IN.27.007
Pivot inferior (fixo) /
Lower pivot (fixed) / Pivote inferior (fijo).

MATERIAL: EN 1.4301 / AISI 304

ACABAMENTO / FINISH / ACABADO: STANDARD: SATINADO / SATIN / SATIN

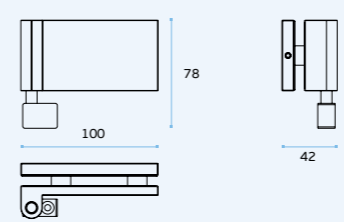

IN.27.002
Dobradiça inferior com retentor /
Lower hinge with retaining stopper / Bisagra inferior con retenedor.

MATERIAL: EN 1.4301 / AISI 304

ACABAMENTO / FINISH / ACABADO: STANDARD: SATINADO / SATIN / SATIN

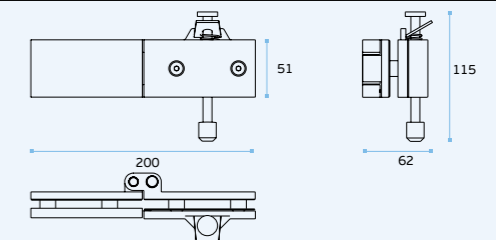

SOLUÇÕES DE FERRAGENS PARA PORTAS DE FOLE E PARQUE /
GLASS HARDWARE SOLUTIONS FOR FOLDING & PARK DOORS /
SOLUCIONES DE HERRAJES PARA PUERTAS PLEGABLES Y DE PARQUE



IN.27.013
Retenor /
 Retaning stop / Retenedor

MATERIAL: EN 1.4301 / AISI 304
ACABAMENTO / FINISH / ACABADO: STANDARD: SATINADO / SATIN / SATIN

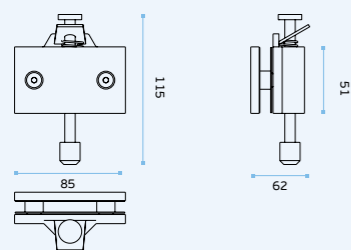

IN.27.010.5800
Carril superior (5800mm) /
 Upper track (5800mm) / Carril superior (5800mm).

MATERIAL: EN 1.4301 / AISI 304
ACABAMENTO / FINISH / ACABADO: STANDARD: SATINADO / SATIN / SATIN

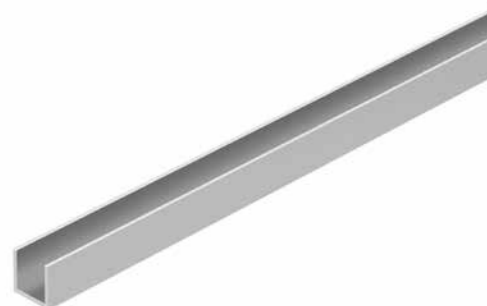
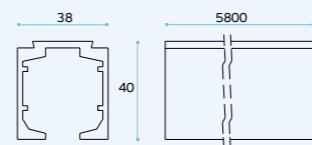

IN.27.011
Calha inferior (5800mm) /
 Lower truck (5800mm) / Perfil inferior (5800mm)

MATERIAL: EN 1.4301 / AISI 304
ACABAMENTO / FINISH / ACABADO: STANDARD: SATINADO / SATIN / SATIN

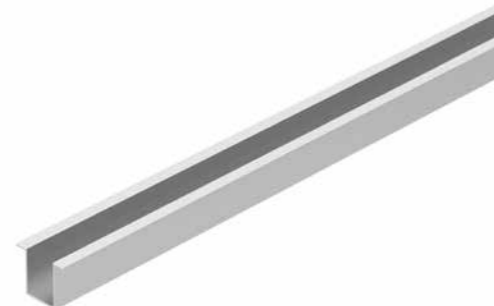
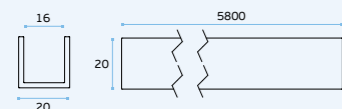

IN.27.012
Calha inferior (5800mm) /
 Lower truck (5800mm) / Perfil inferior (5800mm)

MATERIAL: EN 1.4301 / AISI 304
ACABAMENTO / FINISH / ACABADO: STANDARD: SATINADO / SATIN / SATIN

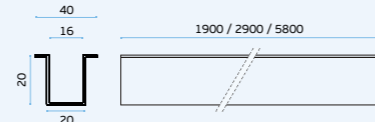

- 1 > IN.27.002
- 2 > IN.27.007
- 3 > IN.27.004
- 4 > IN.27.004
- 5 > IN.27.003

SOLUÇÕES DE FERRAGENS PARA PORTAS DE FOLE E PARQUE /
GLASS HARDWARE SOLUTIONS FOR FOLDING & PARK DOORS /
SOLUCIONES DE HERRAJES PARA PUERTAS PLEGABLES Y DE PARQUE

PARK SYSTEM

VERSÁTIL NA GESTÃO DE ESPAÇOS PÚBLICOS:

**ESPAÇOS COMERCIAIS, SHOWROOMS, SALAS DE CONFERÊNCIAS,
MUSEUS, EMPRESAS, ESCOLAS, RESTAURANTES, HOTÉIS... /**

VERSATILE IN MANAGING PUBLIC SPACES:

**COMMERCIAL AREAS, SHOWROOMS, CONFERENCE ROOMS, MUSEUMS,
COMPANIES, SCHOOLS, RESTAURANTS, HOTELS...**

VERSÁTIL EN LA GESTIÓN DE ESPACIOS PÚBLICOS:

**ÁREAS COMERCIALES, SHOWROOMS, SALAS DE CONFERENCIAS,
MUSEOS, EMPRESAS, ESCUELAS, RESTAURANTES, HOTELES...**



SISTEMA PARK / PARK SYSTEM SISTEMA PARK



Há um crescimento na procura de soluções para versatilizar o uso de espaços: zonas comerciais, showrooms, salas de conferência, museus, empresas, escolas, restauração, hotelaria, etc.

Pretende-se uma maior flexibilidade no uso do espaço disponível, tornando-o dinâmico.

O objetivo é otimizar o uso deste espaço. Com a nossa solução, o volume do espaço pode ser configurado muito rapidamente compartimentando áreas de forma rápida através de painéis suspensos deslizantes.

Trilhos envidraçados superiores e inferiores proporcionam ao sistema a estabilidade necessária, estando os componentes funcionais auxiliares discretamente escondidos dentro do perfil. A transparência da parede deslizante, contribui para dissimular áreas compartimentadas.

Os painéis podem ser estacionados em diferentes posições. A folga entre as folhas de vidro pode ser diminuída com a utilização de um vedante adequado.

A vantagem deste sistema é a ausência de guias no piso, o pavimento não é alterado, existem apenas pontos de fecho ao pavimento para travamento do conjunto. A compartimentação das áreas deve contemplar um carril superior que pode estar dissimulado no tecto e que suporta todo o conjunto de painéis amovíveis.

There is a growing demand for solutions to make the use of spaces more versatile: commercial areas, showrooms, conference rooms, museums, companies, schools, restaurants, hotels, etc.

Greater flexibility in the use of available space is intended, making it dynamic.

The aim is to optimize the use of this space. With our solution, the volume of the space can be configured very quickly, quickly compartmentalizing areas through sliding suspended panels.

Upper and lower glazed rails provide the system with the necessary stability, the auxiliary functional components being discreetly hidden within the profile. The transparency of the sliding wall contributes to disguising compartmentalized areas.

Panels can be parked in different positions. The gap between the glass sheets can be reduced with the use of a suitable sealant.

The advantage of this system is the absence of guides on the floor, the floor is not altered, there are only locking points on the floor to lock the set. The partitioning of areas must include an upper rail that can be concealed in the ceiling and that supports the entire set of removable panels.

Existe una demanda creciente de soluciones para hacer más versátil el uso de los espacios: áreas comerciales, showrooms, salas de conferencias, museos, empresas, escuelas, restaurantes, hoteles, etc.

Se pretende una mayor flexibilidad en el uso del espacio disponible, dinamizándolo.

El objetivo es optimizar el uso de este espacio. Con nuestra solución se puede configurar muy rápidamente la volumetría del espacio, compartimentando rápidamente las zonas mediante paneles correderos suspendidos.

Los rieles superiores e inferiores acristalados dotan al sistema de la estabilidad necesaria, quedando discretamente ocultos dentro del perfil los elementos funcionales auxiliares. La transparencia de la pared corredera contribuye a disimular zonas compartimentadas.

Los paneles se pueden aparcar en diferentes posiciones. El espacio entre las hojas de cristal se puede reducir con el uso de un sellador adecuado.

La ventaja de este sistema es la ausencia de guías en el suelo, el suelo no se altera, solo hay puntos de bloqueo en el suelo para bloquear el conjunto. La compartimentación de zonas debe incluir un carril superior que pueda ocultarse en el techo y que soporte todo el conjunto de paneles desmontables.

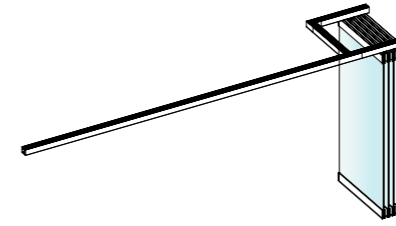
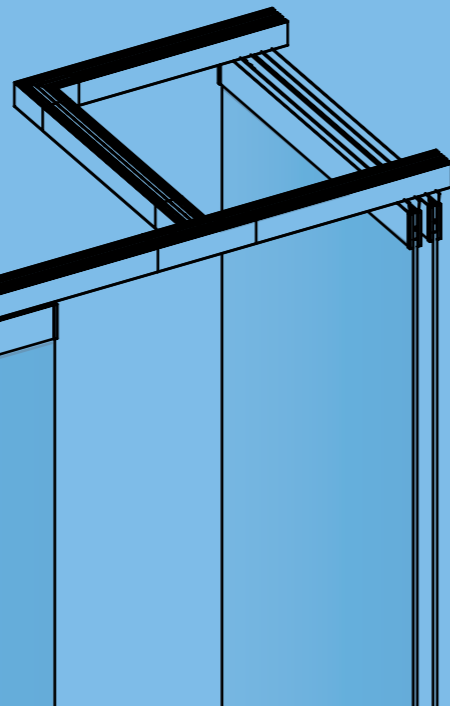

FULL OPEN

TOTALMENTE ABERTO:

O sistema na posição de "parking" pode ser facilmente armazenado. No pavimento não há carris, apenas pequenos pontos de fecho.

FULL OPEN:

The system in parking position can be easily stored. On the floor there is no tracks, just small points where the locks close.

TOTALMENTE ABIERTO:

El sistema en posición de "parking" se puede almacenar fácilmente. En el pavimento no hay carriles, solo pequeños puntos de cierre.

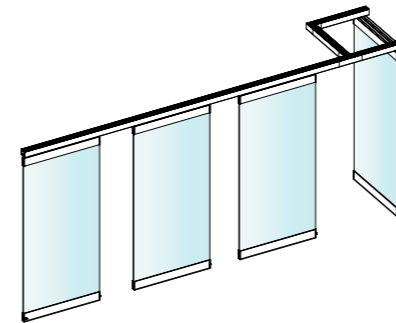

OPENNING

ABERTURA

O processo de abertura é muito fácil e apenas uma pessoa pode abrir todo o sistema, mesmo com portas de 150kg.

A modularidade do sistema permite construir estruturas muito amplas com múltiplas portas.

OPENNING

The opening process is very easy and one person is enough for the operation of all system, even with doors with 150kg.

The modularity of the system allows you to build very wide structures with multiple doors.

APERTURA

El proceso de apertura es muy fácil y solo una persona puede abrir todo el sistema, incluso con puertas de 150kg.

La modularidad del sistema permite construir estructuras con achos muy grandes y con múltiples puertas.

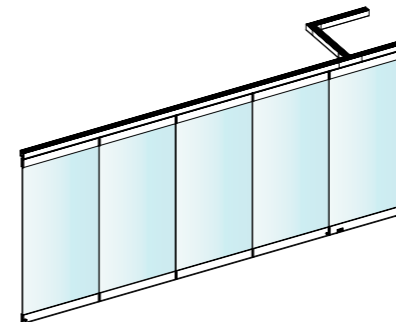

FULL CLOSE

TOTALMENTE FECHADO

O sistema quando totalmente fechado está completamente seguro, todas as folhas estão fechadas pelo interior no pavimento e a primeira (porta pivotante) está a bloquear todo o movimento do sistema.

FULL CLOSE

The system when fully closed is completely secure, all leaf are locked from inside to the floor and the first one (pivot door) is blocking the movement of all system.

TOTALMENTE CERRADO

Quando está completamente cerrado, el sistema es completamente seguro, todas las hojas están cerradas desde el interior hasta el suelo y la primera (puerta pivotante) bloquea todo movimiento del sistema.

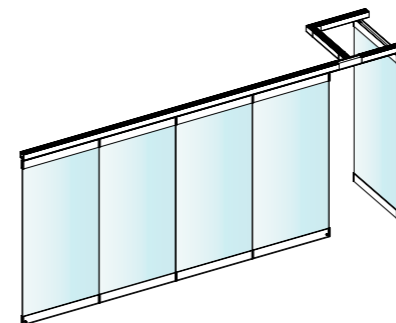

PASSAGE DOOR

PORTA DE PASSAGEM

A primeira porta é pivotante, pode ser instalada com mola de porta ou pivot livre. Esta porta tem uma função adicional, serve para bloquear as restantes portas quando estão em "Park".

PASSAGE DOOR

The first door is pivot, can be installed with door closer or free pivot. This door has one additional function, to block the remaining doors when they are in "Park".

PUERTA DE PASO

La primera puerta es pivotante, se puede instalar con muelle de puerta o de pivote libre. Esta puerta tiene una función adicional, sirve para bloquear las otras puertas cuando están en "Park".

SISTEMA PARK / PARK SYSTEM SISTEMA PARK



Zona de "PARK" com portas visíveis. A primeira porta a abrir é a pivotante e depois as restantes.

Parking zone with the doors visible. First door to open is the pivot and then the remaining.

Zona "PARK" con puertas visibles. La primera puerta a abrir es la de pivote y luego las demás.



Zona de "PARK" com portas ocultas. A primeira porta a abrir é a pivotante e depois as restantes.

Parking zone with the doors hidden. First door to open is the pivot and then the remaining.

Zona "PARK" con puertas ocultas. La primera puerta a abrir es la de pivote y luego las demás.

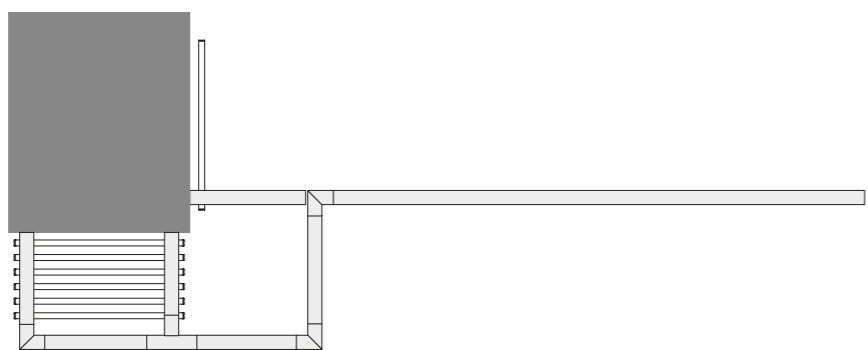

Zona de "PARK" com portas ocultas. A pivotante oculta as restantes.

Parking zone with the doors hidden. The pivot door hides the remaining.

Zona "PARK" con puertas ocultas. La puerta pivotante esconde el resto.

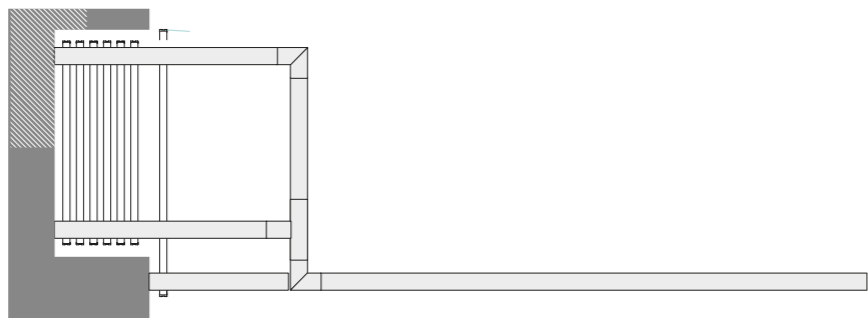

Zona de "PARK" com portas ocultas. A pivotante oculta as restantes.

Parking zone with the doors hidden. The pivot door hides the remaining.

Zona "PARK" con puertas ocultas. La puerta pivotante esconde el resto.

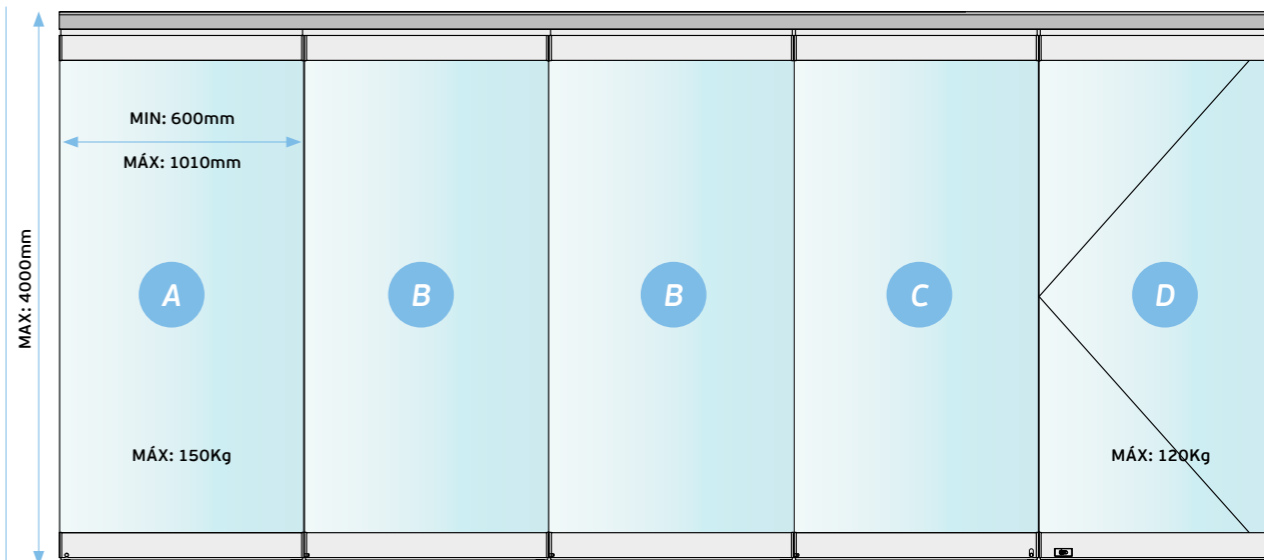
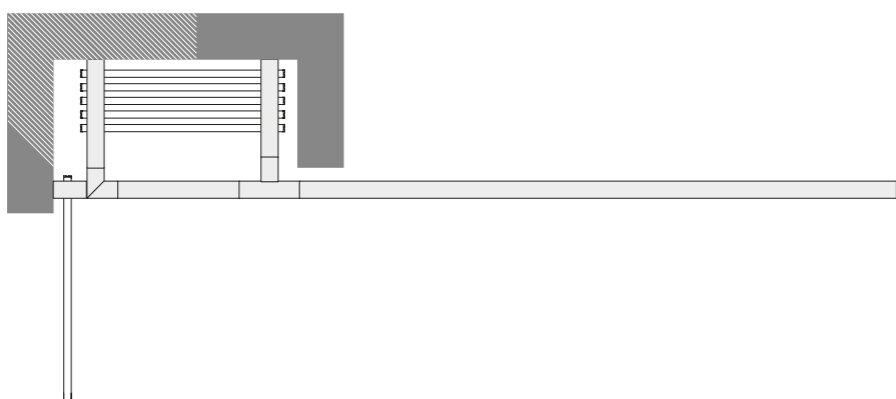

A
Painel inicial
Initial panel
Panel inicial
Min: 600mm
Max: 1010mm

Capacidade / Capacity / Capacidade
MAX: 150Kg

B
Painel intermédio
Intermediate panels
Paine intermedio
Min: 600mm
Max: 1010mm

Capacidade / Capacity / Capacidade
MAX: 150Kg

C
Painel final
Final panel
Panel final
Min: 600mm
Max: 1010mm

Capacidade / Capacity / Capacidade
MAX: 150Kg

D
Porta lateral pivotante
Pivot side door
Puerta lateral pivotante
Min: 600mm
Max: 1010mm

Capacidade / Capacity / Capacidade
MAX: 120Kg



Fórmula para calcular a altura do vidro da porta /
Formula to calculate the High of the glass door/
Formula para calcular lo altura del cristal de puerta.

$$B = A - 275$$

Fórmula para calcular largura das portas /
Formula to calculate the door widths /
Formula para calcular la anchura de las puertas.

$$X = \frac{T}{P}$$

Fórmula para calcular a medida do perfil da porta /
Formula to calculate the size of the door profile /
Formula para calcular lo ancho de lo perfil de puerta.

$$Z = X - 13$$

Fórmula para calcular a largura do vidro da porta /
Formula to calculate the wide of the glass door/
Formula para calcular lo ancho de lo cristal de puerta.

$$W = X - 3$$

A = Altura do vão de instalação /
Door clear height / Altura libre de hueco
B = Altura do vidro da porta /
Door glass height / Altura de cristal de puerta
X = Largura das portas /
Door width / Ancho de puerta
Z = Largura do perfil /
Profile width / ancho de perfil.
W = Largura do vidro /
Door width / Ancho de cristal
P = Número de portas /
Number of doors / Numero de puertas
T = Largura total /
Total wide / Anchura total.
Y = Distância entre carris = distância entre carris na zona de parque /
Distance between cars = distance between tracks in the parking zone.
Distancia entre poleas = distancia entre guías en la zona del parque.

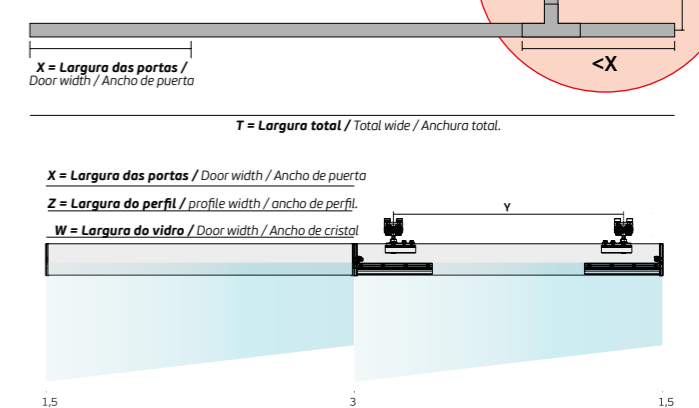
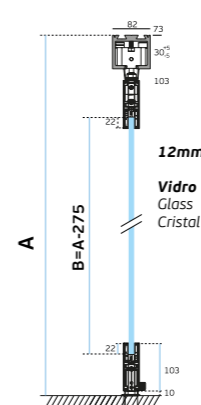

SISTEMA PARK /
PARK SYSTEM
SISTEMA PARK



IN.15.551
Carril superior (3000mm) /
Upper track (3000mm) /
Carril superior (3000mm).

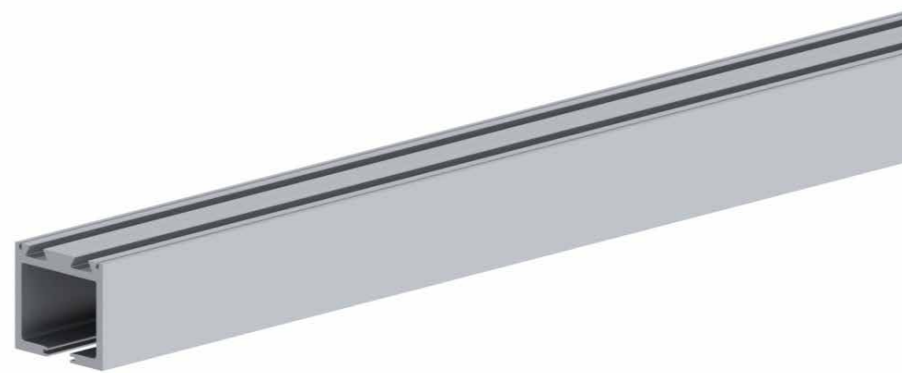

IN.15.552.E
União em "T" (Esquerda) /
"T" shaped union (Left) /
Unión en "T" (Izquierda)



IN.15.553
União em "L" /
"L" shaped union /
Unión en "L".



IN.15.552.D
União em "T" (Direita) /
"T" shaped union (Right) /
Unión en "T" (Derecha)



IN.15.550
Calha superior / inferior 1000mm
Lower and upper track 1000mm
Perfil inferior y superior 1000mm.

APLICAÇÃO / APPLICATION: A B C D



- A**

IN.15.550
+
IN.15.550.1
- B**

IN.15.550
+
IN.15.550.3
- C**

IN.15.550
+
IN.15.550.2
- D**

IN.15.550
+
IN.15.550.4
+
21.2205
+
21.001R

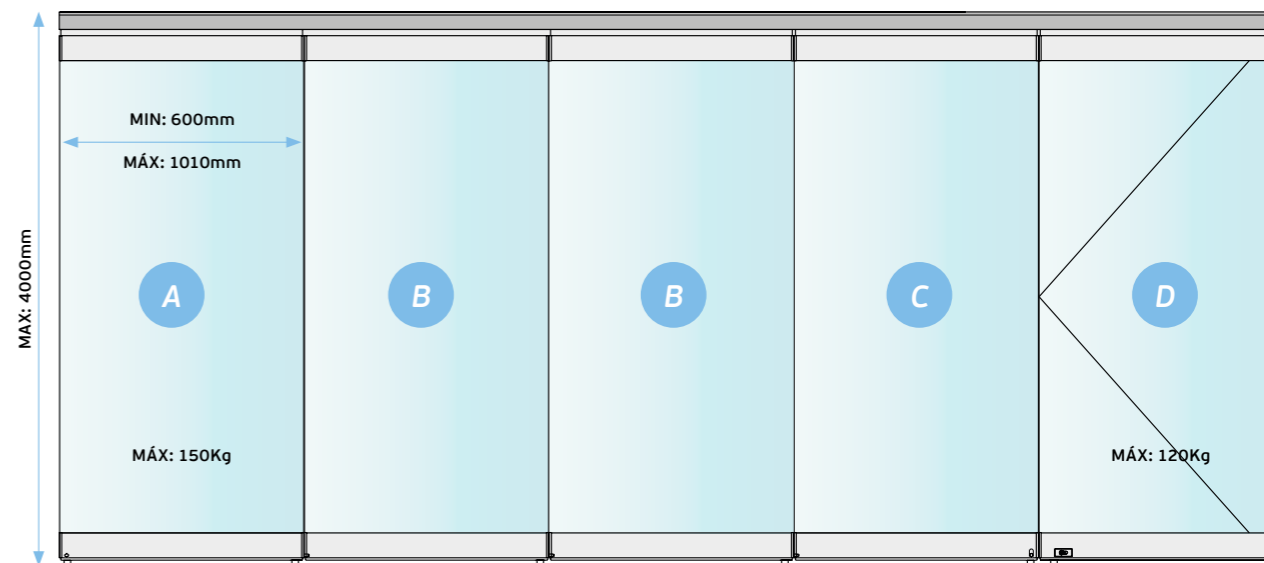

- A**

Painel inicial
Initial panel
Panel inicial
Min: 600mm
Max: 1010mm

Capacidade /
Capacity /
Capacidad
MAX: 150Kg
- B**

Painel intermédio
Intermediate panels
Paine intermedio
Min: 600mm
Max: 1010mm

Capacidade /
Capacity /
Capacidad
MAX: 150Kg
- C**

Painel final
Final panel
Panel final
Min: 600mm
Max: 1010mm

Capacidade /
Capacity /
Capacidad
MAX: 150Kg
- D**

Porta lateral pivotante
Pivot side door
Puerta lateral pivotante
Min: 600mm
Max: 1010mm

Capacidade /
Capacity /
Capacidad
MAX: 120Kg

SISTEMA PARK / PARK SYSTEM SISTEMA PARK

IN.15.550.1

Kit para painel inicial /
Kit for initial panel /
Kit para panel inicial.

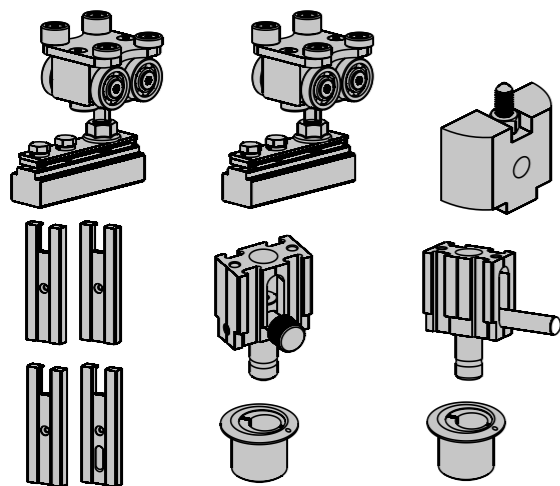

APLICAÇÃO /
APPLICATION: **A**

IN.15.550.2

Kit para painel final /
Kit for final panel /
Kit para panel final.

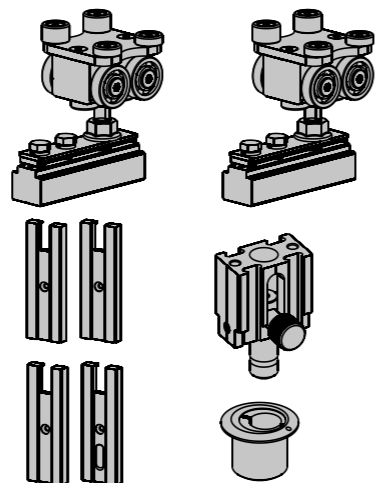

APLICAÇÃO /
APPLICATION: **C**

IN.15.550.3

Kit para painéis intermédios /
Kit for middle panels /
Kit para painéis intermedios.

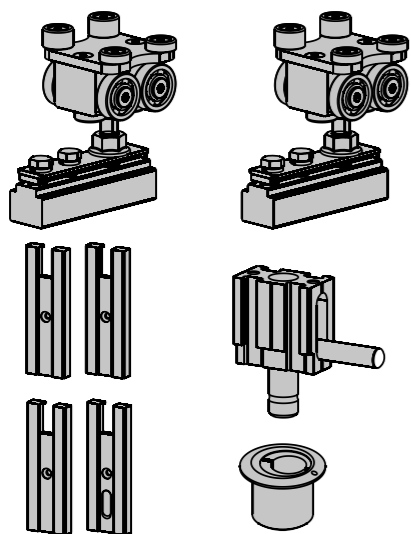

APLICAÇÃO /
APPLICATION: **B**

IN.15.550.4

Kit para porta pivotante. Para usar
com pivot IN.81.108 e mola de pavimento
21.2205 + 21.001.R /

Kit for pivot door. To use with pivot IN.81.108
and pavement spring 21.2205 + 21.001.R /
Kit para puerta pivotante. Para usar con pivote
IN.81.108 y muelle de pavimento 21.2205 + 21.001.R.

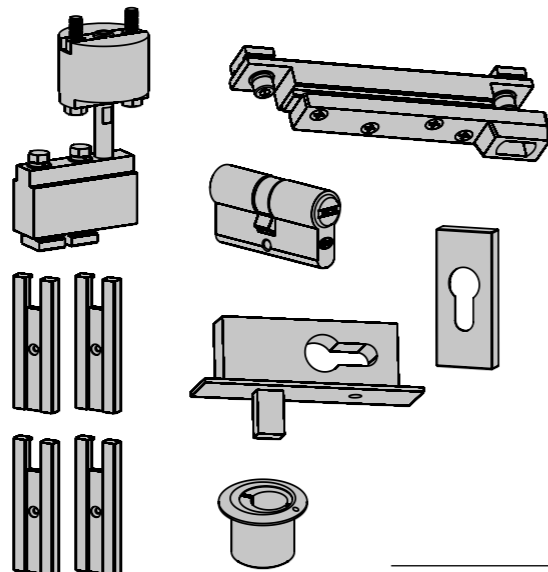

APLICAÇÃO /
APPLICATION: **D**



IN.81.108

Giro de pavimento ajustável
Rolamento que garante
um funcionamento suave e
silencioso /

Adjustable free floor pivot. Ball
bearing. That ensures a smooth
and quiet function. /

Pivote de pavimento ajustable.
Rodamiento que garantiza un
movimiento suave y silencioso.

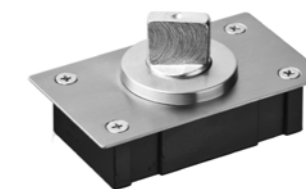

21.2205

Mola de pavimento para portas de
batente ou vai-vém aplicável em
portas de madeira, metálicas ou
de vidro, com paragem a 90° /

Floor closer for single action doors
or double action doors applicable to
wooden, metallic or glass doors with
hold open position at 90° /

Cierra puertas de suelo para puertas
de batiente o doble acción, aplicable
a puertas de madera, metálicas o de
cristal con retención a 90°.

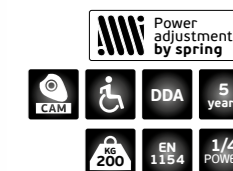

EN1154 3 8 4 1 1 3

21.2205.B

Mola de pavimento para portas
de batente ou vai-vém aplicável
em portas de madeira, metálicas
ou de vidro sem paragem /

Floor closer for single action doors
or double action doors applicable
to wooden, metallic or glass doors
without hold open position /
Cierra puertas de suelo para puertas
de batiente o doble acción, aplicable
a puertas de madera, metálicas o de
cristal sin retención.



EN1154 3 8 4 1 1 3

21.001.R

Quadra 22x11,6 mm.
Altura standard 3mm /
Spindle 22x11,6mm.
Standard height 3mm /
Cuadradillo 22x11,6mm
Altura estándar 3mm.



21.001.R10

Quadra elevada 22x11,6 mm.
Altura 10mm /
Elevated Spindle 22x11,6mm.
Height 10mm /
Cuadradillo elevado 22x11,6mm
Altura 10mm.



21.001.R20

Quadra elevada 22x11,6 mm.
Altura 20mm /
Elevated Spindle 22x11,6mm.
Height 20mm /
Cuadradillo elevado 22x11,6mm
Altura 20mm.



LINEAR POLARIS AUTOMATIC SYSTEM

SISTEMAS AUTOMÁTICOS PARA PORTAS DE CORRER /
AUTOMATIC SLIDING DOOR SYSTEM /
SISTEMA DE PUERTAS CORREDEAS AUTOMÁTICAS.

O sistema automático LINEAR POLARIS é um mecanismo para portas de correr sem as tradicionais correias e motor rotativo. Funciona com um motor linear que exerce o movimento ao longo de um carril magnético permanente, sendo uma das principais vantagens deste sistema o baixo ruído.

Sem as correias e todos os elementos envolventes, fomos capazes de reduzir as dimensões do carril para 60x70mm, criando um perfil muito fino, perfeitamente apropriado para uso no espaço interior.

A instalação e afinação é muito simples (plug and play). Este mecanismo permite conectar um grande número de periféricos tais como sensores de movimento, teclados numéricos, botões, controlo remoto, etc.

A tecnologia utilizada, juntamente com um firmware otimizado, permite criar um controlo total das configurações do sistema. Por exemplo, o peso automático da porta e alta sensibilidade a qualquer obstrução encontrada no percurso. Tornando o sistema muito seguro. Permite instalação em portas de duas folhas sincronizadas sem correias.

PRINCIPAIS CARACTERÍSTICAS:

- Largura da abertura desobstruída: 600-1400mm;
- Comprimento do operador: 1250-2850mm;
- Velocidade de abertura: ajustável 200 e 800mm/seg;
- Velocidade de fecho: 200mm/seg
- EN16005 "Low Energy"
- Peso guia: 8-10kg

DIMENSÕES DO CARRIL:

60mm (altura) x 70mm (largura)

PESO PORTA:

Min. 5kg / Máx. 80kg

OUTRAS CARACTERÍSTICAS:

- Ruído funcionamento: <50dB
- Uso: Contínuo
- Número de ciclos: >1,000,000

The automatic LINEAR POLARIS system is a mechanism for sliding doors without the traditional belts and rotary motor. It works with a linear motor that carries the movement along a permanent magnetic rail, being one of the main advantages of this system the low noise.

Without the belts and all the surrounding elements, we were able to reduce the gutter dimensions to 60x70mm, creating a very thin profile, perfectly suited for use in the interior space.

Installation and tuning is very simple (plug and play). This mechanism allows you to connect a large number of peripherals such as motion sensors, numeric keypads, buttons, remote control, etc.

The technology used, together with an optimized firmware, allows you to create a complete control of the system settings, for example, the automatic weight of the door, high sensitivity to any obstruction found in the route, making the system very safe. Suitable for double synchronized doors without belts.

MAIN FEATURES:

- Clear opening width: 600-1400mm
- Operator length: 1250-2850mm
- Opening speed: adjustable between 200 and 800mm/sec
- Closing speed: 200mm/sec
- EN16005 "Low Energy"
- Guide weight: 8-10kg

TRACK DIMENSIONS:

60mm (height) x 70mm (width)

LEAF WEIGHT:

Min. 5kg / Max. 80kg

OTHER FEATURES:

- Operating noise: <50dB
- Use: Continuous
- Number of cycles: >1,000,000



O sistema automático LINEAR POLARIS es un mecanismo de puerta corredera sin las correas tradicionales y motor rotativo. Funciona con un motor lineal que ejerce el movimiento a lo largo de un carril magnético permanente, siendo una de las principales ventajas de este sistema el bajo ruido.

Sin las correas y todos los elementos involucrados, hemos sido capaces de reducir el tamaño del carril para 60x70mm, creando un perfil muy delgado y perfectamente adecuado para su uso en interiores.

La instalación y el ajuste es muy simple, (plug and play). Este mecanismo permite conectar un gran número de Periféricos como Sensores de movimiento, teclados, botones, control remoto, etc.

La tecnología utilizada junto con una firmware optimizado, permite crear un control completo de las configuraciones del sistema, por ejemplo, peso automático de la puerta, alta sensibilidad a cualquier obstáculo que se encuentra en el camino, haciendo el sistema muy seguro. Permite la instalación en puertas de dos hojas sincronizadas sin correas.

PRINCIPALES CARACTERÍSTICAS:

- Ancho de abertura clara: 600-1400mm
- Longitud del operador: 1250-2850mm
- Velocidad de apertura: ajustable entre 200 y 800mm/seg
- Velocidad de cierre: 200mm/seg
- EN16005 "Low Energy"
- Peso de la guía: 8-10kg

DIMENSIONES DEL CARRIL:

60mm (alto) x 70mm (ancho)

PESO PUERTA:

Min. 5kg / Max. 80kg

OTRAS CARACTERÍSTICAS:

- Ruido de funcionamiento: <50dB
- Uso: Continuo
- Número de ciclos: >1,000,000



plug
and play



auto
move



easy to
instal



soft
closing



silent
movement



push
button



key pad
control



push
and go



motion
sensor



magic
button



remote
control



mifare
card
reader

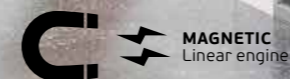

LINEAR POLARIS

AUTOMATIC SLIDING DOOR SYSTEMS

SISTEMAS PARA PORTAS DE
CORRER AUTOMÁTICAS/
AUTOMATIC SLIDING DOOR SYSTEMS /
SISTEMAS DE PUERTAS CORREDEAS
AUTOMÁTICAS.

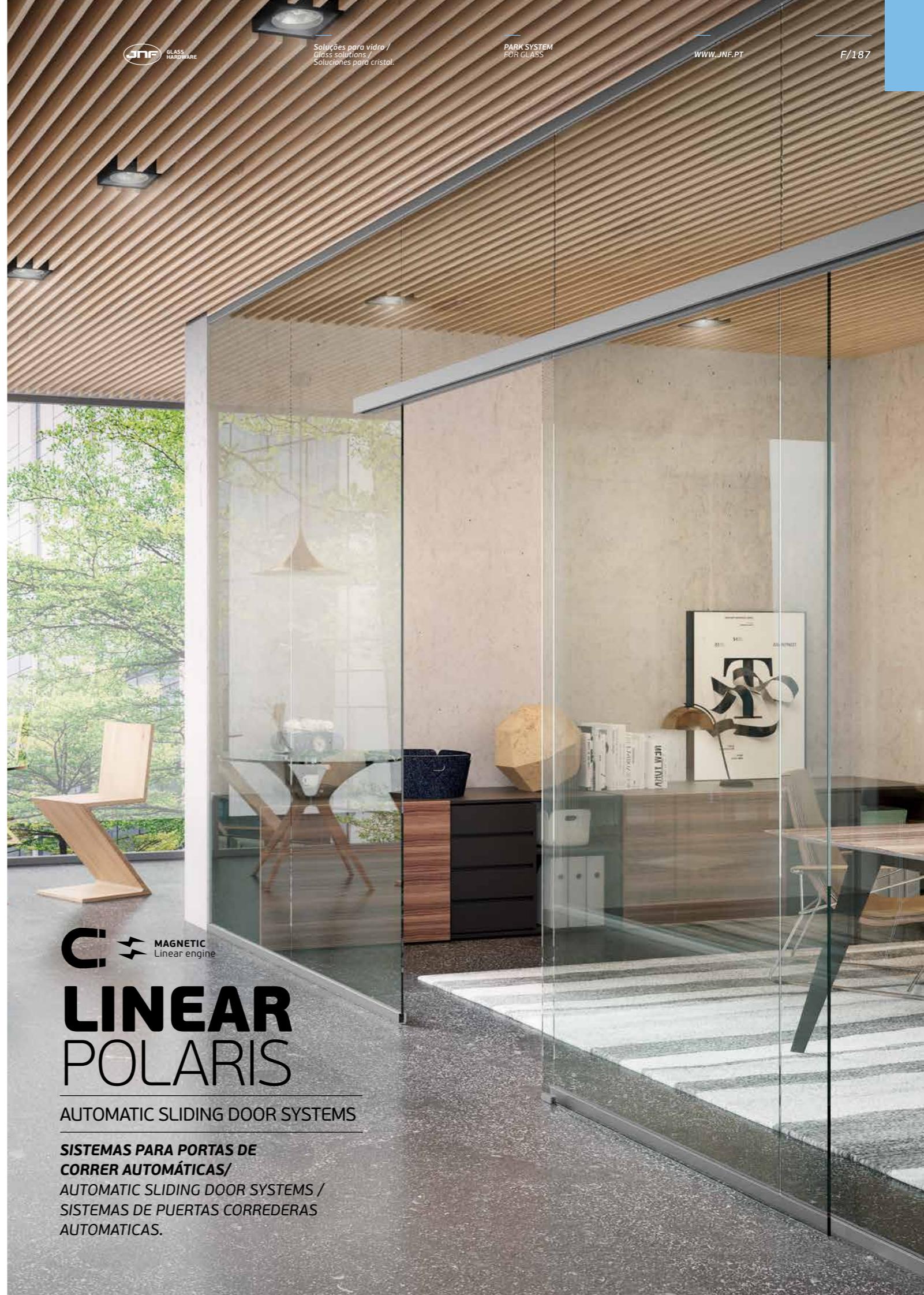

LINEAR POLARIS AUTOMATIC SYSTEM

SISTEMAS AUTOMÁTICOS PARA PORTAS DE CORRER /
AUTOMATIC SLIDING DOOR SYSTEM /
SISTEMA DE PUERTAS CORREDERAS AUTOMÁTICAS.

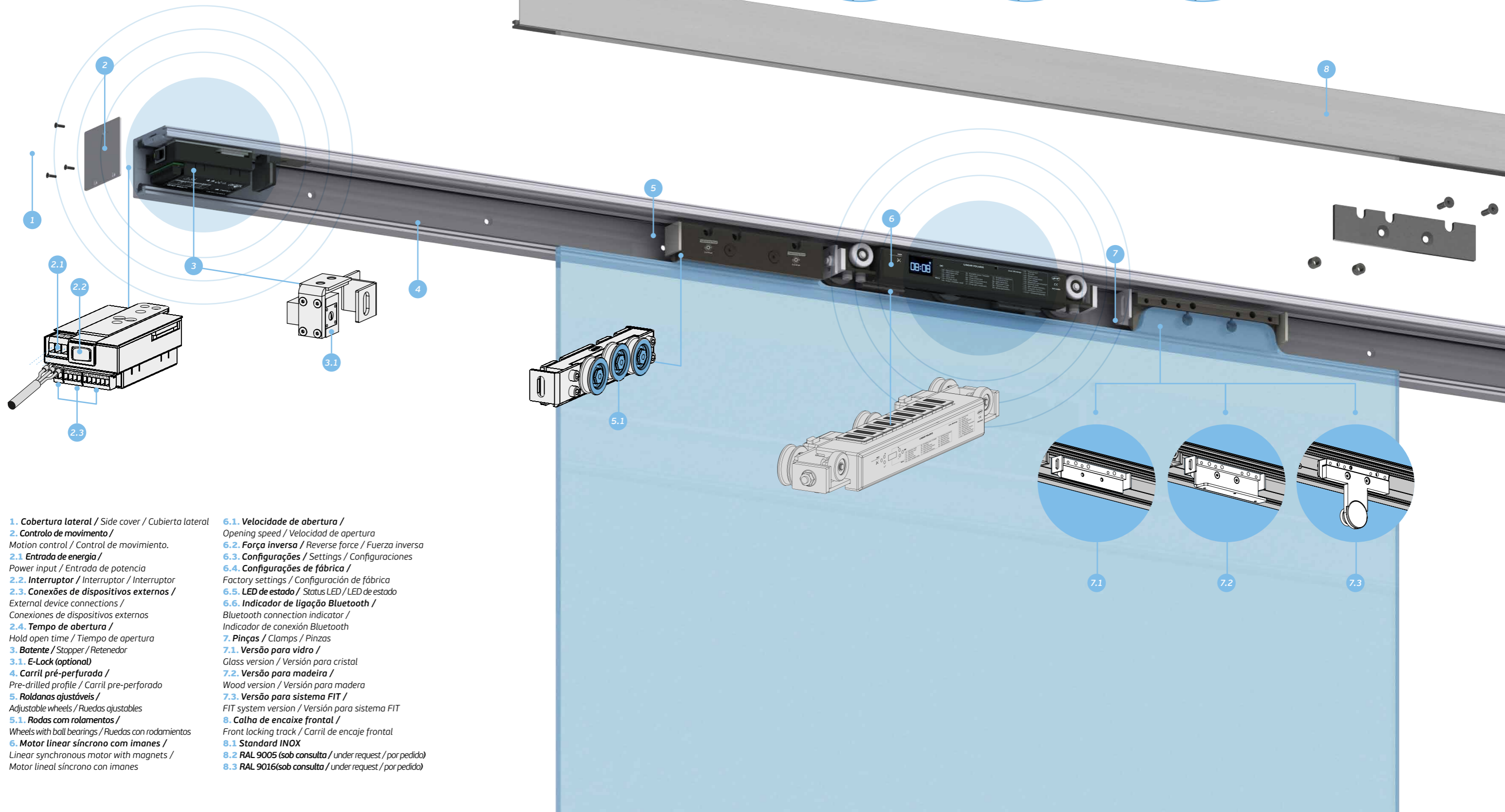
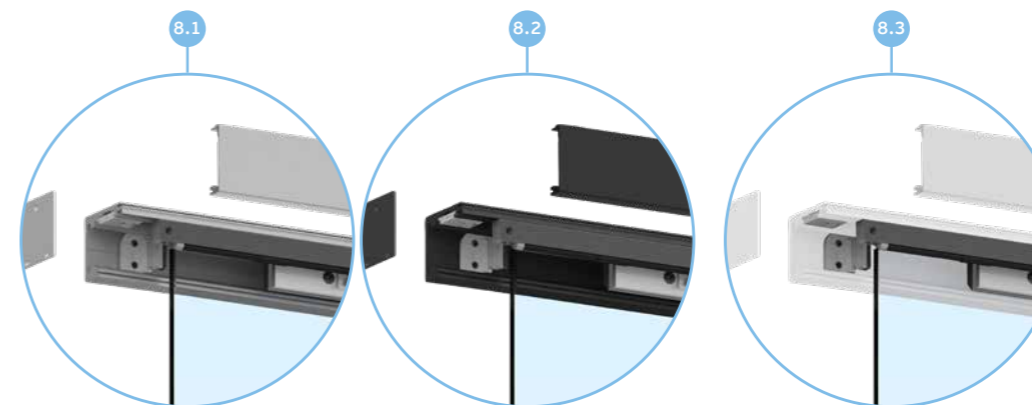

- 1. Cobertura lateral / Side cover / Cubierta lateral**
2. Controlo de movimento /
Motion control / Control de movimiento.
2.1 Entrada de energia /
Power input / Entrada de potencia
2.2. Interruptor / Interruptor / Interruptor
2.3. Conexões de dispositivos externos /
External device connections /
Conexiones de dispositivos externos
2.4. Tempo de abertura /
Hold open time / Tiempo de apertura
3. Batente / Stopper / Retenedor
3.1. E-Lock (optional)
4. Carril pré-perfurada /
Pre-drilled profile / Carril pre-perforado
5. Roldanas ajustáveis /
Adjustable wheels / Ruedas ajustables
5.1. Rodas com rolamentos /
Wheels with ball bearings / Ruedas con rodamientos
6. Motor linear síncrono com imanes /
Linear synchronous motor with magnets /
Motor lineal síncrono con imanes

- 6.1. Velocidade de abertura /**
Opening speed / Velocidad de apertura
6.2. Força inversa / Reverse force / Fuerza inversa
6.3. Configurações / Settings / Configuraciones
6.4. Configurações de fábrica /
Factory settings / Configuración de fábrica
6.5. LED de estado / Status LED / LED de estado
6.6. Indicador de ligação Bluetooth /
Bluetooth connection indicator /
Indicador de conexión Bluetooth
7. Pinças / Clamps / Pinzas
7.1. Versão para vidro /
Glass version / Versión para cristal
7.2. Versão para madeira /
Wood version / Versión para madera
7.3. Versão para sistema FIT /
FIT system version / Versión para sistema FIT
8. Calha de encaixe frontal /
Front locking track / Carril de encaje frontal
8.1 Standard INOX
8.2 RAL 9005 (sob consulta / under request / por pedido)
8.3 RAL 9016 (sob consulta / under request / por pedido)

LINEAR POLARIS AUTOMATIC SYSTEM

SISTEMAS AUTOMÁTICOS PARA PORTAS DE CORRER / AUTOMATIC SLIDING DOOR SYSTEM / SISTEMA DE PUERTAS CORREDERAS AUTOMÁTICAS.



FOR GLASS DOORS



O sistema automático LINEAR POLARIS é um mecanismo para portas de correr sem as tradicionais correias e motor rotativo. Funciona com um motor linear que exerce o movimento ao longo de um carril magnético de baixo ruído.

The automatic LINEAR POLARIS system is a mechanism for sliding doors without the traditional belts and rotary motor. It works with a linear motor that carries the movement along a permanent magnetic rail, being one of this system the low noise.

O sistema automático LINEAR POLARIS es un mecanismo de puerta corredera sin las correas tradicionales y motor rotativo. Funciona con un motor lineal que ejerce el movimiento a lo largo de un carril magnético permanente, con bajo ruido.

AUTOMATIC LINEAR POLARIS

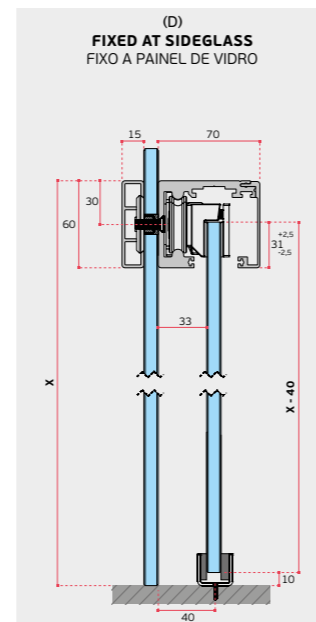
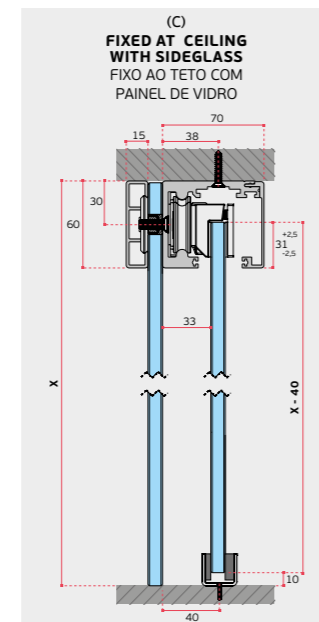
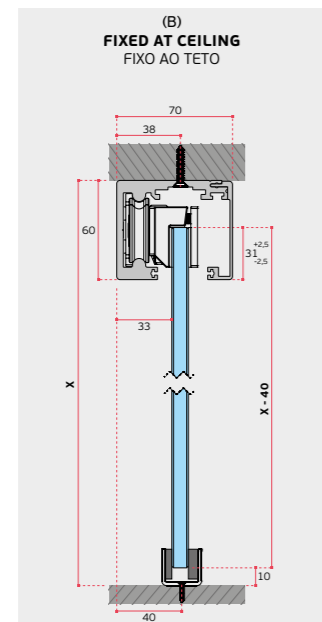
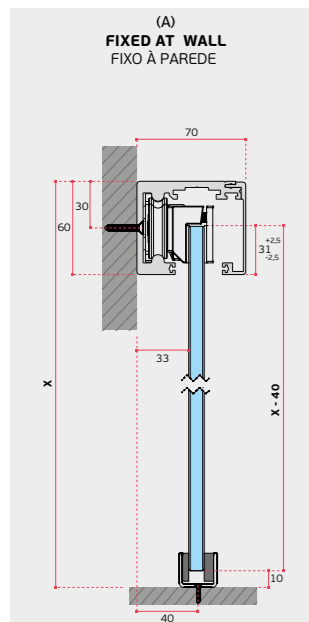

(A) FIXED AT WALL / FIXO À PAREDE.

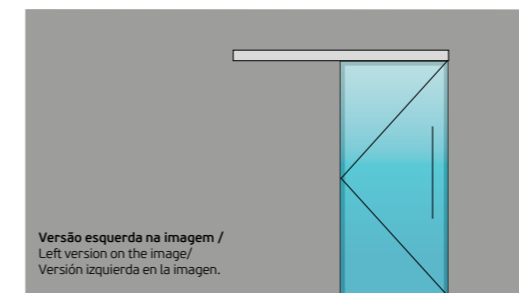

IN.15.702.2000.D
IN.15.702.3000.D
(Direita / Right / Derecha)

IN.15.702.2000.E
IN.15.702.3000.E
(Esquerda / Left / Izquierda)

sistema de porta de correr automático / Automatic sliding door system / Sistema automático de puertas correderas.

(B) FIXED AT CEILING / FIXO NO TETO

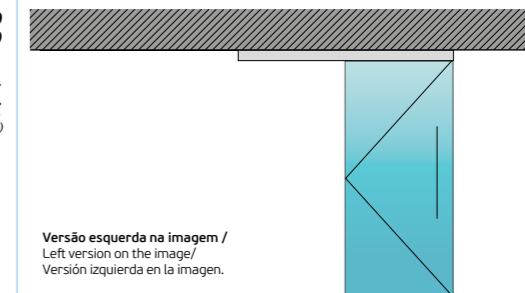

IN.15.702.2000.D
IN.15.702.3000.D
(Direita / Right / Derecha)

IN.15.702.2000.E
IN.15.702.3000.E
(Esquerda / Left / Izquierda)

sistema de porta de correr automático / Automatic sliding door system / Sistema automático de puertas correderas.

(C) FIXED AT CEILING WITH SIDE GLASS / FIXO AO TETO COM PAINEL DE VIDRO

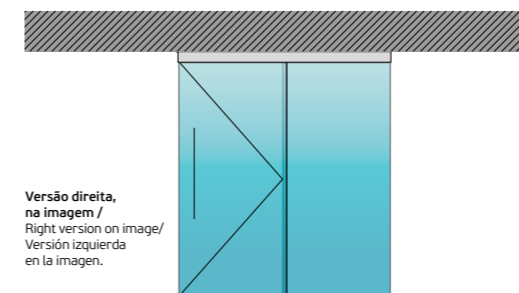

IN.15.702.2000.D
IN.15.702.3000.D
(Direita / Right / Derecha)

IN.15.702.2000.E
IN.15.702.3000.E
(Esquerda / Left / Izquierda)

sistema de porta de correr automático / Automatic sliding door system / Sistema automático de puertas correderas.

IN.15.707.2000
IN.15.707.3000
Calha para suspensão no vidro fixo / Track for suspension on fixed glass / Carril para sujetar al cristal fijo.

(D) FIXED AT GLASS / FIXO NO VIDRO

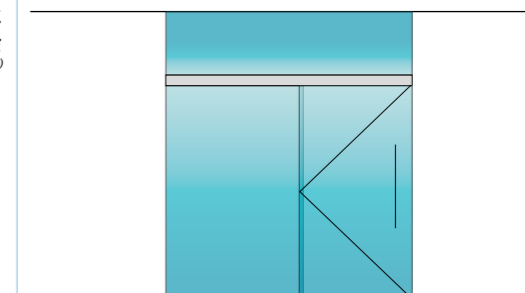

IN.15.702.2000.D
IN.15.702.3000.D
(Direita / Right / Derecha)

IN.15.702.2000.E
IN.15.702.3000.E
(Esquerda / Left / Izquierda)

sistema de porta de correr automático / Automatic sliding door system / Sistema automático de puertas correderas.

IN.15.707.2000
IN.15.707.3000
Calha para suspensão no vidro fixo / Track for suspension on fixed glass / Carril para sujetar al cristal fijo.

LINEAR POLARIS SINCRO AUTOMATIC SYSTEM

SISTEMAS AUTOMÁTICOS PARA PORTAS DE CORRER / AUTOMATIC SLIDING DOOR SYSTEM / SISTEMA DE PUERTAS CORREDERAS AUTOMÁTICAS.



FOR GLASS DOORS

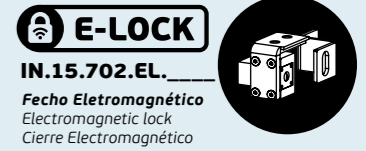

AUTOMATIC LINEAR POLARIS SINCRO

O sistema automático LINEAR POLARIS é um mecanismo para portas de correr sem as tradicionais correias e motor rotativo. Funciona com um motor linear que exerce o movimento ao longo de um carril magnético de baixo ruído.

The automatic LINEAR POLARIS system is a mechanism for sliding doors without the traditional belts and rotary motor. It works with a linear motor that carries the movement along a permanent magnetic rail, being one of this system the low noise.

O sistema automático LINEAR POLARIS es un mecanismo de puerta corredera sin las correas tradicionales y motor rotativo. Funciona con un motor lineal que ejerce el movimiento a lo largo de un carril magnético permanente, con bajo ruido.

AUTOMATIC LINEAR POLARIS SINCRO

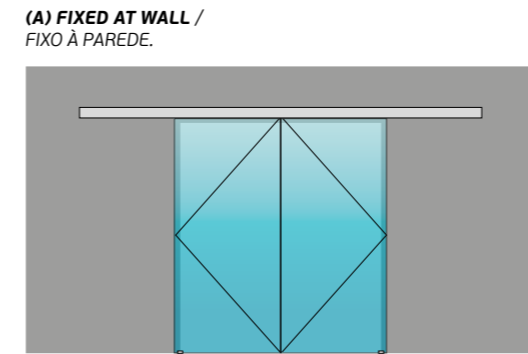
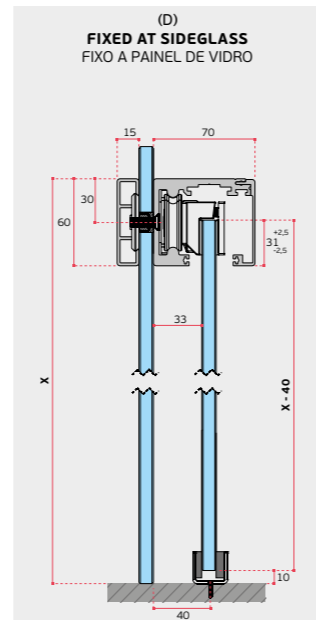
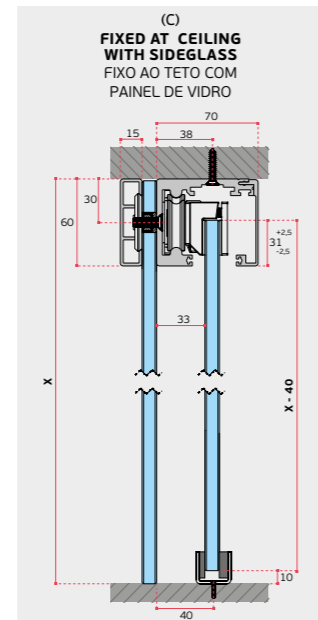
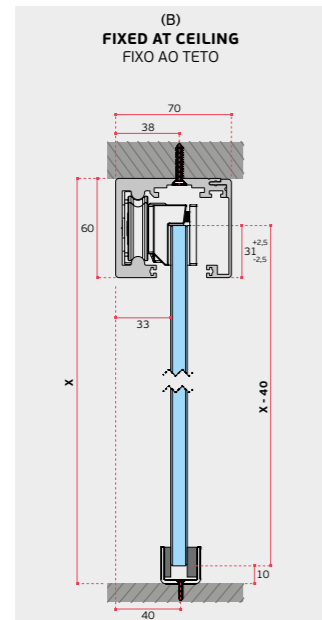
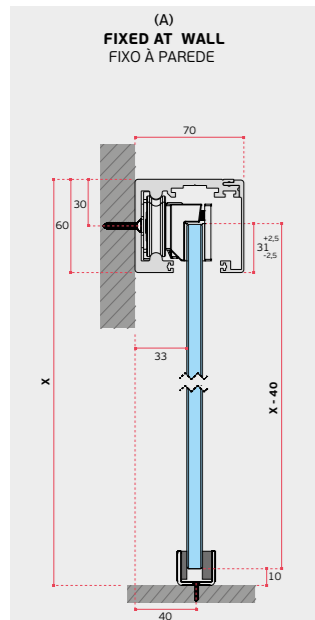

IN.15.702.4000
IN.15.702.6000
sistema de porta de correr automática sincronizada / Synchronized automatic sliding door system / sistema de puertas correderas automáticas sincronizadas /

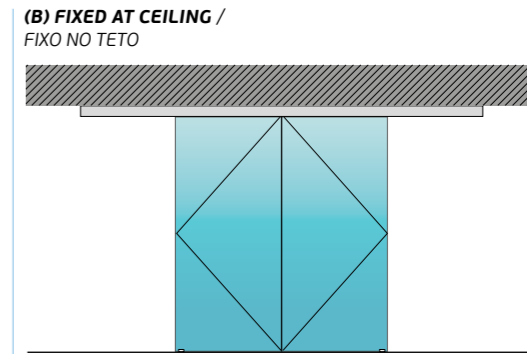

IN.15.702.4000
IN.15.702.6000
sistema de porta de correr automática sincronizada / Synchronized automatic sliding door system / sistema de puertas correderas automáticas sincronizadas /

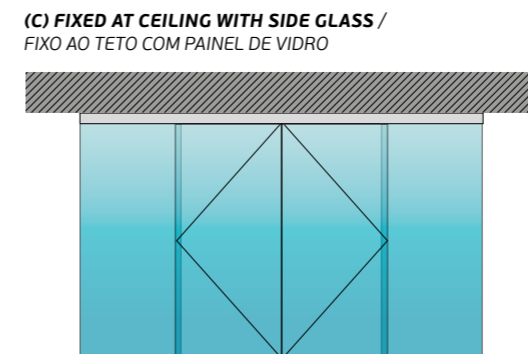

IN.15.702.4000
IN.15.702.6000
sistema de porta de correr automática sincronizada / Synchronized automatic sliding door system / sistema de puertas correderas automáticas sincronizadas /

IN.15.707.4000
IN.15.707.6000
Calha para suspensão no vidro fixo / Track for suspension on fixed glass / Carril para sujetar al cristal fijo.

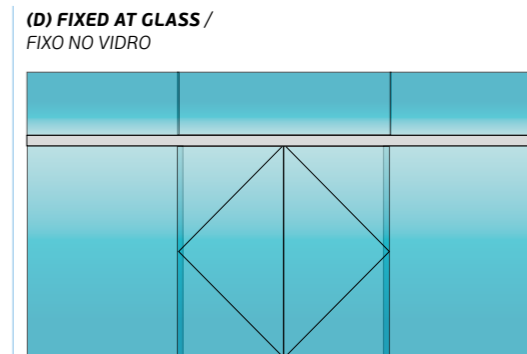

IN.15.702.4000
IN.15.702.6000
sistema de porta de correr automática sincronizada / Synchronized automatic sliding door system / sistema de puertas correderas automáticas sincronizadas /

IN.15.707.4000
IN.15.707.6000
Calha para suspensão no vidro fixo / Track for suspension on fixed glass / Carril para sujetar al cristal fijo.

LINEAR POLARIS AUTOMATIC SYSTEM

SISTEMAS AUTOMÁTICOS PARA PORTAS DE CORRER / AUTOMATIC SLIDING DOOR SYSTEM / SISTEMA DE PUERTAS CORREDERAS AUTOMÁTICAS.



FOR GLASS DOORS



IN.15.702.EL.

Fecho Eletromagnético / Electromagnetic lock / Cierre Electromagnético

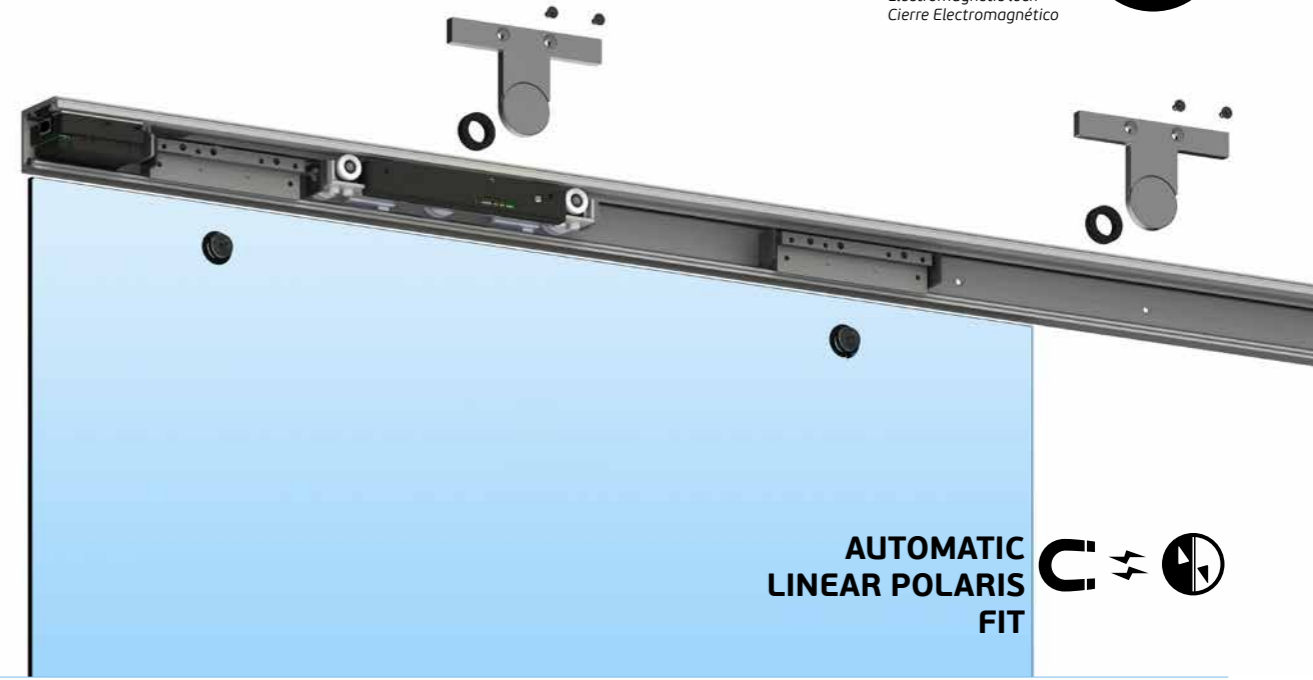
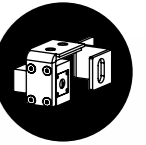

AUTOMATIC LINEAR POLARIS FIT

O sistema automático LINEAR POLARIS é um mecanismo para portas de correr sem as tradicionais correias e motor rotativo. Funciona com um motor linear que exerce o movimento ao longo de um carril magnético de baixo ruído.

The automatic LINEAR POLARIS system is a mechanism for sliding doors without the traditional belts and rotary motor. It works with a linear motor that carries the movement along a permanent magnetic rail, being one of this system the low noise.

O sistema automático LINEAR POLARIS es un mecanismo de puerta corredera sin las correas tradicionales y motor rotativo. Funciona con un motor lineal que ejerce el movimiento a lo largo de un carril magnético permanente, con bajo ruido.

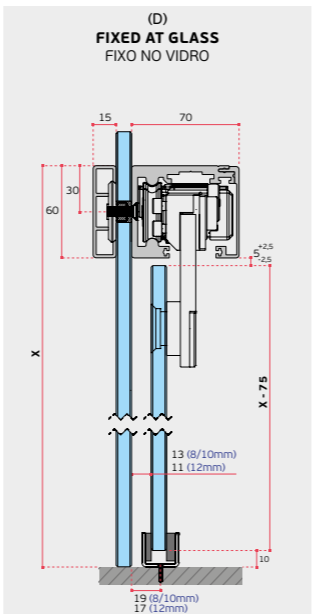
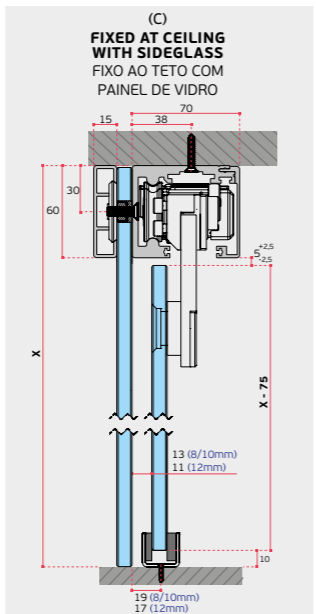
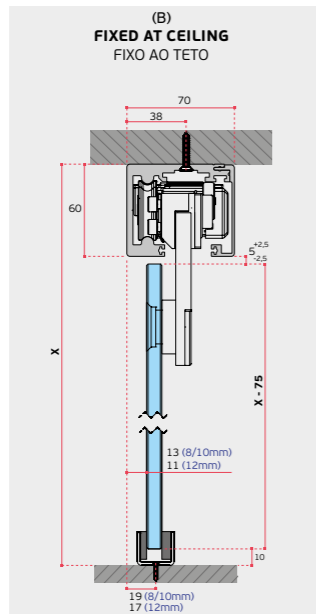
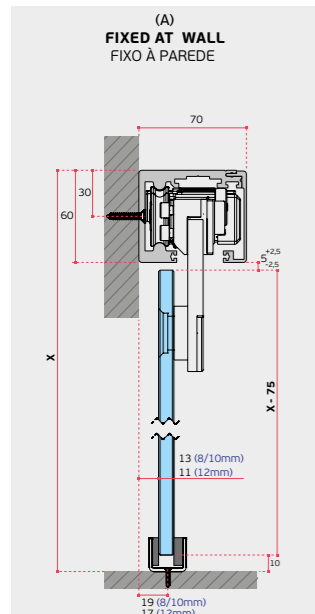

(A) FIXED AT WALL / FIXO À PAREDE.

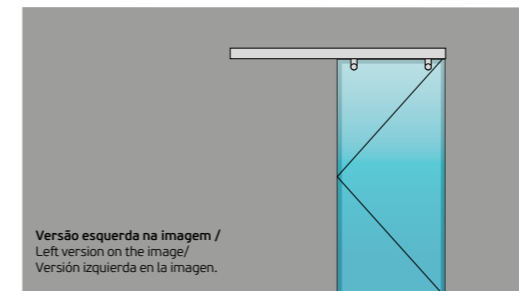

IN.15.704.2000.D
IN.15.704.3000.D
(Direita / Right / Derecha)

IN.15.704.2000.E
IN.15.704.3000.E
(Esquerda / Left / Izquierda)

sistema de porta de correr automático / Automatic sliding door system / Sistema automático de puertas correderas.

Versão esquerda na imagem / Left version on the image / Versión izquierda en la imagen.

(B) FIXED AT CEILING / FIXO NO TETO

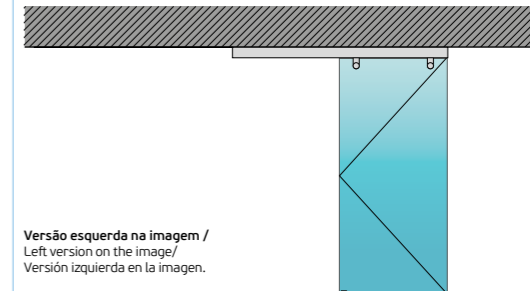

IN.15.704.2000.D
IN.15.704.3000.D
(Direita / Right / Derecha)

IN.15.700.2000.E
IN.15.700.3000.E
(Esquerda / Left / Izquierda)

sistema de porta de correr automático / Automatic sliding door system / Sistema automático de puertas correderas.

Versão esquerda na imagem / Left version on the image / Versión izquierda en la imagen.

(C) FIXED AT CEILING WITH SIDE GLASS / FIXO AO TETO COM PAINEL DE VIDRO

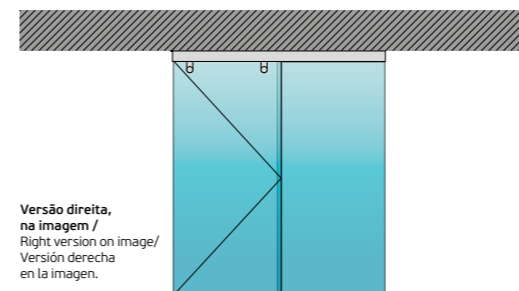

IN.15.704.2000.D
IN.15.704.3000.D
(Direita / Right / Derecha)

IN.15.704.2000.E
IN.15.704.3000.E
(Esquerda / Left / Izquierda)

sistema de porta de correr automático / Automatic sliding door system / Sistema automático de puertas correderas.

Versão direita, na imagem / Right version on image / Versión derecha en la imagen.

IN.15.707.2000
IN.15.707.3000
Cilha para suspensão no vidro fixo / Track for suspension on fixed glass / Carril para sujetar al cristal fijo.

MECANO ELECTRON AUTOMATIC SYSTEM

SISTEMAS AUTOMÁTICOS PARA PORTAS DE CORRER /
 AUTOMATIC SLIDING DOOR SYSTEM /
 SISTEMA DE PUERTAS CORREDEAS AUTOMÁTICAS.

VANTAGENS DO PRODUTO:

- Fácil instalação.
- Baixo ruído (máx. 55dB)
- Alta durabilidade, teste de 500.000 ciclos em porta de 80kg com baixo requerimento de manutenção.
- Movimento de porta de baixa energia.
- Alta segurança para pessoas com mobilidade reduzida ou condicionada, crianças e animais de estimação. A velocidade da porta é limitada e o possível contacto com o utilizador ou obstáculo é sempre inofensivo
- A força exercida para parar a porta durante qualquer ponto do percurso (A força não deve exceder 67N de acordo com EN 16005)
- Durante a falha de energia, a porta pode ser aberta manualmente.
- Push & Go: O sistema automático básico não precisa de sensor de movimento ou botão para abrir. Pode ser acionada com um ligeiro toque de dedo para abrir ou fechar a porta.
- Hit & Return: A porta recua em contato com um obstáculo, oferecendo maior segurança para idosos, pessoas com mobilidade condicionada, crianças, animais de estimação, etc.
- Ampla gama de tensão de alimentação de 100VAC~240VAC, flexível para países com fontes de alimentação instáveis.
- Baixo consumo de energia:
Modo automático 40Watt
Modo de espera 5Watt
- Design elegante e contemporâneo com carril ultra pequeno de 75x77mm, para parede, teto e vidro montado, sem corte de vidro e sem ferragens visíveis por fora.

NORMAS:
 EN16005:2012: Portas automáticas pedonais operadas por energia (para durabilidade, movimento de baixa energia, limitação da força de impacto, etc).

EN ISO 12100:2010: Segurança das máquinas. Avaliação do risco e redução do risco.

EN ISO 13849:2008/AC:2009: Segurança das máquinas. Peças relacionadas com a segurança dos sistemas de controlo

EN 61000-6-1/2/3/4: Compatibilidade eletromagnética EC60335-1/2;

IEC60335-2-103: Diretiva de baixa tensão. Aparelhos eletrodomésticos e análogos ROHS 2011/65/EU.

PRODUCT ADVANTAGES:

- Easy installation.
- Low noise (max. 55dB)
- High durability, 500,000 test cycles on 80kg door with low maintenance requirement.
- Low energy door movement.
- High safety for elderly, handicap, children and pets. The door is limited to travel at certain range of speed with low force when it comes in contact with an obstacle or user during door movement.
- The force to stop the doorset during the door is powered and moving at any point (the force shall not exceed 67N according to EN 16005).
- During power failure, the door can be opened easily by manual.
- Push & Go: Our basic automatic sliding system need no motion sensor or button to trigger the door to open. With slight push of finger to trigger the door to open and close.
- Hit & Return: Door retracts when it comes to contact with an obstacle, offering higher safety for elderly, handicap, children, pets, etc.
- Wide range of power voltage acceptance from 100VAC~240VAC, good for countries with unstable power supply.
- Low power consumption:
Automatic mode 40Watt
Standby mode 5Watt
- Elegant and contemporary design with 75x77mm ultra small track, for wall, ceiling and glass mounted, no glass cut out and no visible hardware outside the track.

STANDARDS:
 EN 16005:2012: Power operated pedestrian doorsets (for durability, low energy movement, limitation of impact force, etc).

EN ISO 12100:2010: Safety of machinery. risk assessment and risk reduction .

EN ISO 13849:2008/AC:2009: Safety of machinery. Safety-related parts of control systems.

EN 61000-6-1/2/3/4: Electromagnetic compatibility EC60335-1/2;

IEC60335-2-103: Low voltage directive. Household and similar electrical appliances ROHS 2011/65/EU.

VENTAJAS DEL PRODUCTO:

- Fácil instalación.
- Bajo ruido (máx. 55dB)
- Alta durabilidad, prueba de 500.000 ciclos en porta 80kg con baja necesidad de mantenimiento.
- Movimiento de porta de baja energía.
- Alta seguridad para adultos, minusválidos, niños y animales de compañía. La velocidad de la puerta es limitada y cualquier posible contacto con el usuario o obstáculo es siempre inofensivo.
- Fuerza ejercida para frenar la puerta en cualquier punto del percurso (a fuerza no puede exceder 67N de acuerdo con EN 16005).
- Durante un corte de energía, la puerta puede ser abierta manualmente.
- Push & Go: Lo sistema automático no necesita de sensor de movimiento o de botón para abrir. Puede abrir o cerrar con un ligero toque.
- Hit & Return: La puerta recua en contacto con un obstáculo, una mayor seguridad para personas mayores, personas con movilidad condicionada, niños, animales, etc.
- Gama de corriente de alimentación de 100VAC~240VAC, flexible para los países con fuentes de alimentación inestables.
- Bajo consumo de energía:
Modo automático 40Watt
Modo de espera 5Watt
- Carril ultra pequeño de 75x77mm, para pared, teto e cristal montado, sin corte de cristal y sin herrajes visibles.

NORMATIVAS:
 EN 16005:2012: Portas automáticas pedonais operadas por energía (para durabilidad, movimiento de baja energía, limitación de fuerza de impacto, etc).

EN ISO 12100:2010: Seguridad de las máquinas. Evaluación del riesgo y reducción del riesgo.

EN ISO 13849:2008/AC:2009: Seguridad de las máquinas. Piezas relacionadas con una seguridad de los sistemas de control

EN 61000-6-1/2/3/4: Compatibilidad electromagnética EC60335-1/2;

IEC60335-2-103: Directiva de baja tensión. Aparatos electrodomésticos y análogos ROHS 2011/65/ UE



MECANO ELECTRON

AUTOMATIC SLIDING DOOR SYSTEMS

SISTEMAS PARA PORTAS DE
 CORRER AUTOMÁTICAS /
 AUTOMATIC SLIDING DOOR SYSTEMS /
 SISTEMAS DE PUERTAS CORREDEAS
 AUTOMATICAS.



MECANO ELECTRON AUTOMATIC SYSTEM

SISTEMAS AUTOMÁTICOS PARA PORTAS DE CORRER /
AUTOMATIC SLIDING DOOR SYSTEM /
SISTEMA DE PUERTAS CORREDERAS AUTOMÁTICAS.



FOR GLASS DOORS

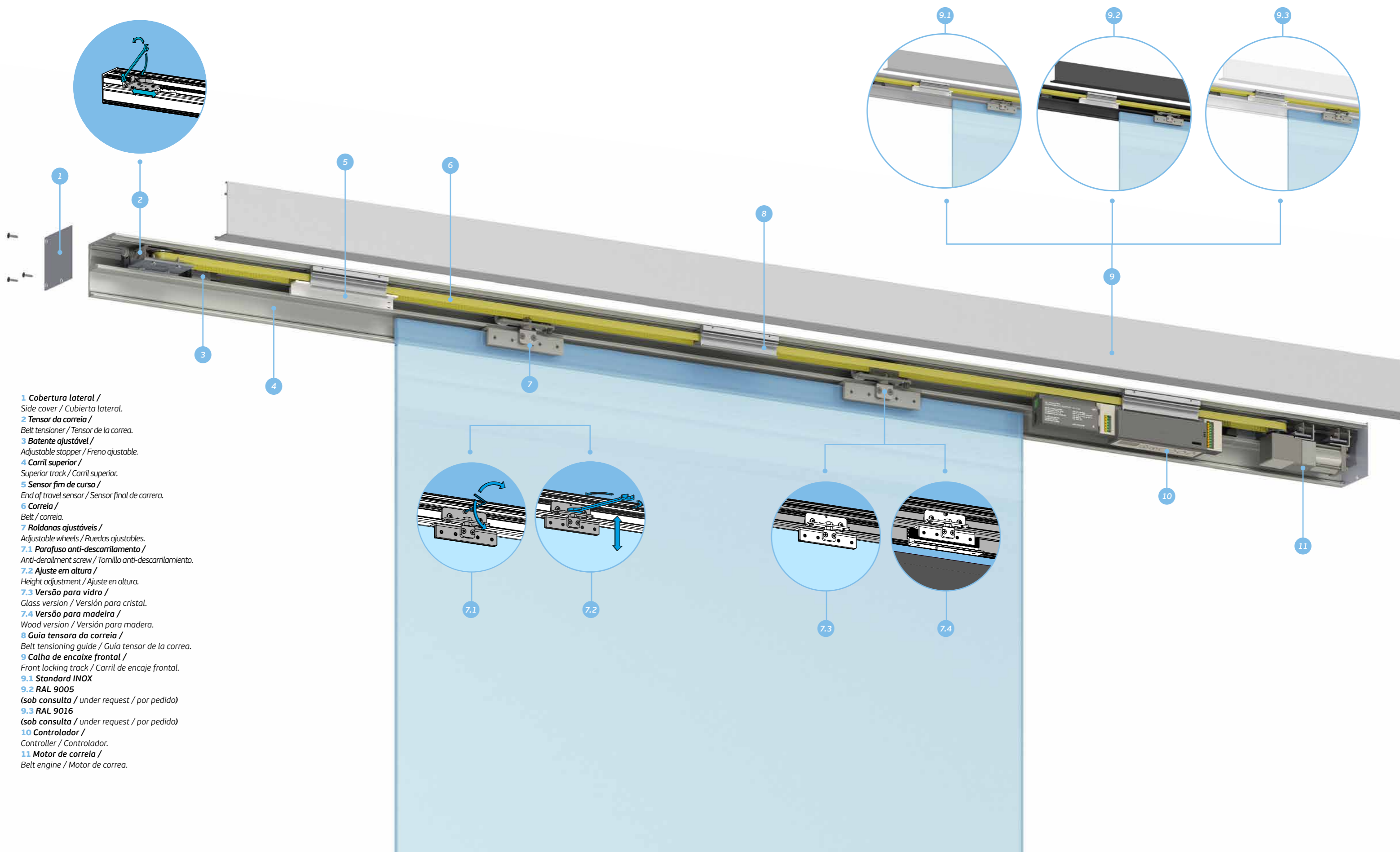

- 1 Cobertura lateral /**
Side cover / Cubierta lateral.
- 2 Tensor da correia /**
Belt tensioner / Tensor de la correa.
- 3 Batente ajustável /**
Adjustable stopper / Freno ajustable.
- 4 Carril superior /**
Superior track / Carril superior.
- 5 Sensor fim de curso /**
End of travel sensor / Sensor final de carrera.
- 6 Correia /**
Belt / correa.
- 7 Roldanas ajustáveis /**
Adjustable wheels / Ruedas ajustables.
- 7.1 Parafuso anti-descarrilamento /**
Anti-derailment screw / Tornillo anti-descarrilamiento.
- 7.2 Ajuste em altura /**
Height adjustment / Ajuste en altura.
- 7.3 Versão para vidro /**
Glass version / Versión para cristal.
- 7.4 Versão para madeira /**
Wood version / Versión para madera.
- 8 Guia tensora da correia /**
Belt tensioning guide / Guía tensor de la correa.
- 9 Calha de encaixe frontal /**
Front locking track / Carril de encaje frontal.
- 9.1 Standard INOX**
- 9.2 RAL 9005**
(sob consulta / under request / por pedido)
- 9.3 RAL 9016**
(sob consulta / under request / por pedido)
- 10 Controlador /**
Controller / Controlador.
- 11 Motor de correia /**
Belt engine / Motor de correa.

MECANO ELECTRON AUTOMATIC SYSTEM

SISTEMAS AUTOMÁTICOS PARA PORTAS DE CORRER /
AUTOMATIC SLIDING DOOR SYSTEM /
SISTEMA DE PUERTAS CORREDERAS AUTOMÁTICAS.



FOR SINGLE GLASS DOORS

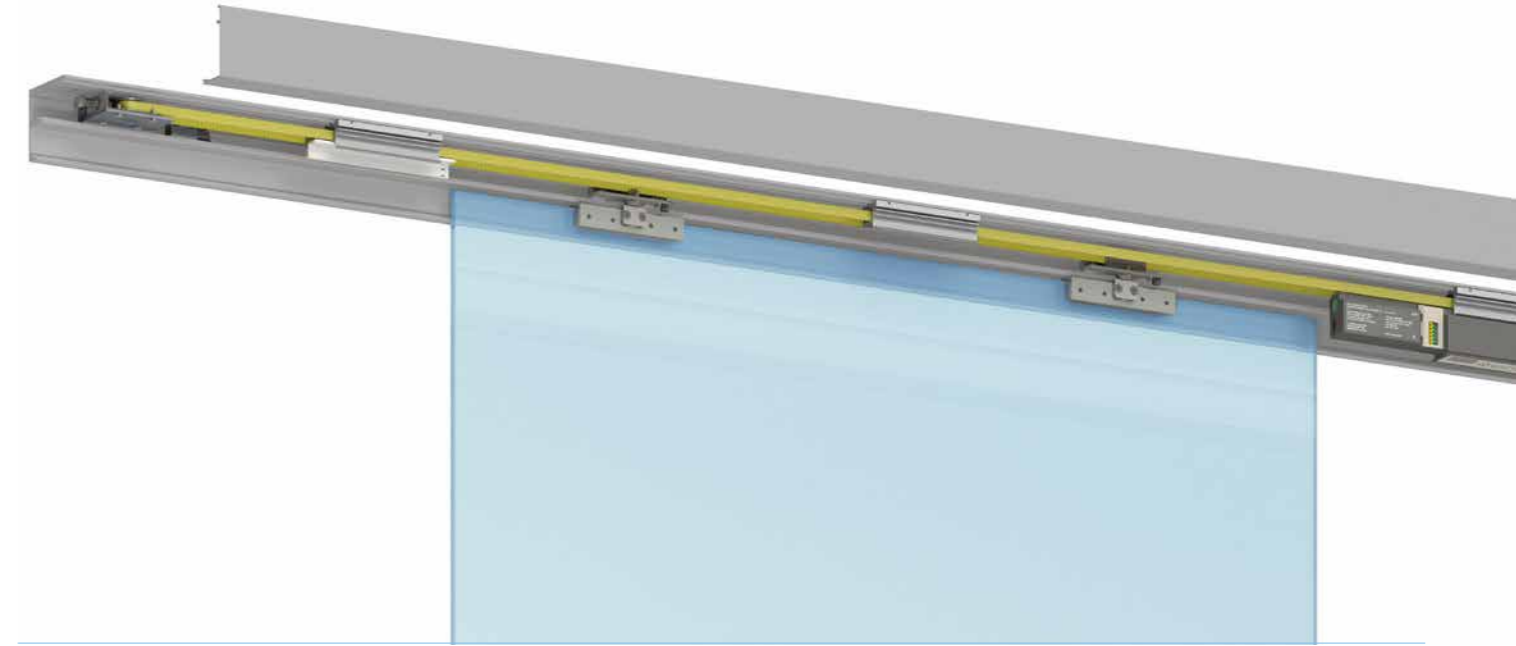

O sistema automático básico não precisa de sensor de movimento ou botão para abrir. Pode ser acionada com um ligeiro toque de dedo para abrir ou fechar a porta.

Basic automatic sliding system need no motion sensor or button to trigger the door to open. With slight push of finger to trigger the door to open and close.

Lo sistema automático no necessita de sensor de movimento o de botón para abrir. Puede abrir o cerrar con un ligero toque.

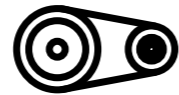

**MECANO
ELETRON**

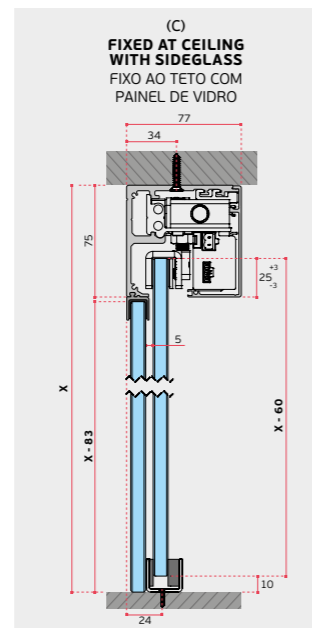
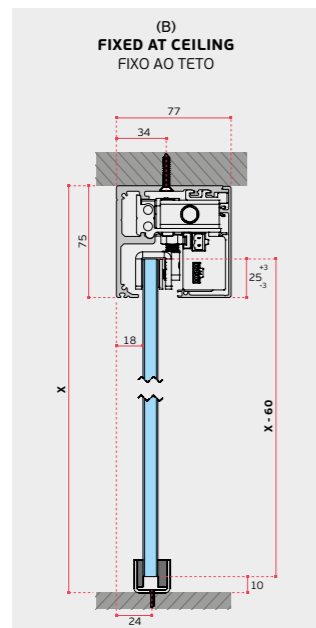
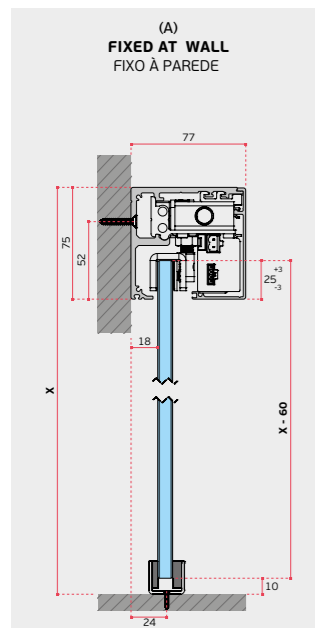

(A) **FIXED AT WALL /**
FIXO À PAREDE.

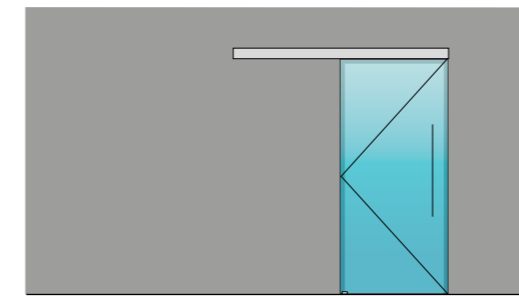

IN.15.743.2000
sistema de porta
de correr automático /
Automatic sliding
door system /
Sistema automático de
puertas correderas.

(B) **FIXED AT CEILING /**
FIXO NO TETO

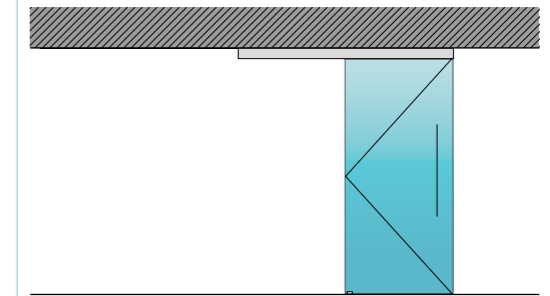

IN.15.743.2000
sistema de porta
de correr automático /
Automatic sliding
door system /
Sistema automático de
puertas correderas.

(C) **FIXED AT CEILING WITH SIDE GLASS /**
FIXO AO TETO COM PAINEL DE VIDRO

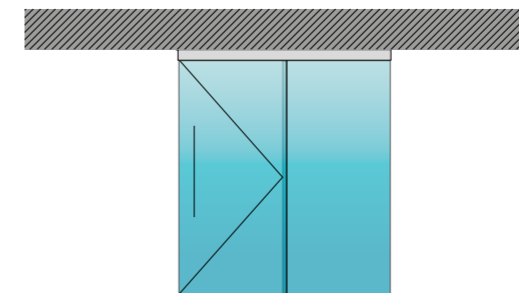

IN.15.743.2000
sistema de porta
de correr automático /
Automatic sliding
door system /
Sistema automático de
puertas correderas

IN.15.427.1500
Cilha para suspensão
no vidro fixo /
Track for suspension on
fixed glass / Carril para
sujetar al cristal fijo.

K7 AUTOMATIC SYSTEM

SISTEMAS AUTOMÁTICOS PARA PORTAS DE CORRER /
 AUTOMATIC SLIDING DOOR SYSTEM /
 SISTEMA DE PUERTAS CORREDEAS AUTOMÁTICAS.

A JNF desenvolveu um sistema de porta de correr automática com um microprocessador com diversas funções que comanda um motor com transmissão por correia, todos os elementos móveis foram desenhados de modo a ter um funcionamento silencioso e com reduzida manutenção, podendo ser utilizado em locais públicos.

A pequena unidade de controlo torna possível a construção de um perfil de alumínio de dimensões reduzidas simultaneamente robusto com todos os componentes ocultos.

Oferecendo uma variedade de configurações e funções, o sistema de porta de correr automática garante uma ampla gama de capacidades no sentido de garantir a sua aplicação nas mais variadas situações.

CARACTERÍSTICAS:

- Peso máx. da porta (uma folha) 150Kg
- Largura da porta 700-1300mm
- Peso máximo da porta (duas folhas) 140Kg cada
- Velocidade de funcionamento 150-500 mm/s (ajustável)
- Velocidade de fecho 150-500mm/s (ajustável)
- Motor 24V 55W motor DC sem escovas
- Tempo de abertura 0-9 segundos (ajustável)
- Input AC 90-250V 50-60Hz
- Temperatura de operação -10 +70°C
- Função sempre aberto
- Função de aprendizagem automática
- Display com códigos de programação
- Certificação CE
- Conexão a central de alarme de incêndio
- Fornecido com sensores micro-ondas de aproximação
- Possibilidade de aplicar com portas de madeira, metálicas ou de vidro
- Pode ser aplicado com uma ou duas folhas de correr. No caso de 2 folhas trabalham sincronizadas
- Modo automático com abertura total
- Modo automático de abertura parcial (ajustável)
- O modo automático em one-way (só saída) para controlo de tráfego
- Modo Offline: a porta pode ser movida à mão
- Sensores de segurança na abertura livre da porta, impede que a porta se feche quando estão pessoas ou objetos na zona de deteção (fotocélulas) (opcional)
- Sistema de inversão de sentido automático. Se as folhas da porta são inibidas de fechar, elas reabrem automaticamente.
- Bateria de emergência: em caso de falha de energia, a bateria opcional irá executar na perfeição o funcionamento (incluindo todos os dispositivos de deteção).
- Dispositivo de fecho eletro-mecânico (opcional)
- Pode ser controlado por um sistema de controlo de acesso (opcional)
- Pode ser controlado por um botão de toque, diferentes modelos disponíveis (opcional)
- Pode ser controlado por receptor e controlo remoto (opcional)
- Pode ser controlado por teclado numérico (opcional)
- Podem ser utilizados os diversos sistemas de comando de fecho em simultâneo.

JNF develop an automatic sliding door system with a microprocessor with various functions which controls a motor with belt, all moving parts are designed to guarantee a perfect, smooth and quiet movement, also low maintenance. It can be used at public buildings.

The control unit with a small size makes it possible to build an aluminum profile with a small dimensions and strong at the same time with all the components hidden.

Offering a wide variety of settings and functions, the automatic sliding door system ensures a wide range of capabilities making it suitable for very different applications.

FEATURES:

- Max door weight (one sheet) 150Kg
- Door width 700-1300mm
- Max door weight (two sheets) 140Kg each
- Operating speed: 150-500 mm/s (adjustable)
- Closing speed: 150-500 mm/s (adjustable)
- Motor 24V 55W brushless DC motor
- Opening time 0-9 seconds (adjustable)
- Input AC 90-250V 50-60 Hz
- Operating temperature -10 +70°C
- Function always open
- Auto learning function
- Display with programming codes
- CE Certification
- Connection to fire alarm central unit
- Supplied with microwave sensors
- Possibility of applying with wooden, metal or glass doors
- It can be applied with one or two sliding leaves. If two doors they work synchronized.
- Automatic mode with full width opening
- Automatic mode adjustable partial opening
- The automatic mode for one-way (one output) for traffic control
- Offline mode: door can be moved by hand
- Safety sensors in the clear opening of the door, preventing the door from closing when are people or objects in the detection zone (photocells) (optional)
- Automatic reverse direction system. If the door leaves are inhibited from closing, they will automatically reopen
- Battery Backup: In the event of power failure, the optional battery will run flawlessly functioning (including all detection devices).
- Locking device electromechanical (optional)
- Can be controlled by an access control system (optional)
- Can be controlled by a button touch, different models available (optional)
- Can be controlled by remote control and receiver (optional)
- Can be controlled by keypad (optional)
- Control of the various closure systems may be used simultaneously

JNF ha desarrollado un sistema de puerta corredera automática con un microprocesador que controla diversas funciones en conjunto con un motor de correa, todas las partes móviles están diseñados de manera que tenga un funcionamiento silencioso y suave y un mantenimiento reducido. Recomendado para lugares públicos.

La unidad de control tiene dimensiones reducidas que hace posible la construcción de un perfil de aluminio pequeño y fuerte al mismo tiempo con todos los componentes ocultos.

Ofreciendo una amplia variedad de configuraciones y funciones, el sistema de la puerta corredera automática garantiza una amplia gama de capacidades para garantizar su aplicación en diferentes situaciones.

CARACTERÍSTICAS:

- Peso máximo de la puerta (una hoja) 150Kg
- Ancho de la puerta 700-1300mm
- Peso máximo de la puerta (dos hojas) 140Kg cada una
- Velocidad de funcionamiento 150-500 mm/s (ajustable)
- Velocidad de cierre 100-450 mm/s (ajustable)
- Motor motor de corriente continua sin escobillas 24V 55W
- Tiempo de apertura 0-9 segundos (ajustable)
- Entrada CA 90-250V 50-60 Hz
- Temperatura de funcionamiento -10 +70°C
- Función siempre abierto
- Función de aprendizaje automático
- Pantalla con códigos de programación
- Certificación CE
- La conexión a central de alarma de incendio
- Suministrado con sensores de microondas de aproximación
- Posibilidad de aplicar con puertas de madera, metal o cristal
- Se puede aplicar con una o dos hojas correderas. Cuando 2 hojas trabajan sincronizadas
- Modo automático con apertura de ancho completo
- Modo automático apertura parcial ajustable
- Modo automático para un solo sentido (una salida) para el control de tráfico
- Modo Offline: puerta se puede mover con la mano
- Sensores de seguridad en la apertura de la puerta, evitando que la puerta se cierre cuando hay personas o objetos en la zona de detección (fotocélulas) (opcional)
- Sistema automático de dirección inversa. Si la hoja de la puerta se bloquea en lo cierre, se reabrirá automáticamente
- Bateria de emergencia: en caso de fallo de alimentación, la batería opcional se ejecutará sin problemas el funcionamiento (incluyendo todos los dispositivos de detección).
- Dispositivo de bloqueo electromecánico (opcional)
- Puede ser controlado por un sistema de control de acceso (opcional)
- Puede ser controlado por un botón táctil, diferentes modelos disponibles (opcional)
- Puede ser controlado por el control y el receptor remoto (opcional)
- Puede ser controlado por teclado numérico (opcional)
- La conexión de los distintos sistemas de cierre puede ser utilizado simultáneamente

 BELT
 MOTOR ENGINE

 BELT
 motor engine



K7 SYSTEM

AUTOMATIC SLIDING DOOR SYSTEMS

SISTEMAS PARA PORTAS DE
 CORRER AUTOMÁTICAS/
 AUTOMATIC SLIDING DOOR SYSTEMS /
 SISTEMAS DE PUERTAS CORREDEAS
 AUTOMATICAS.

K7 AUTOMATIC SYSTEM

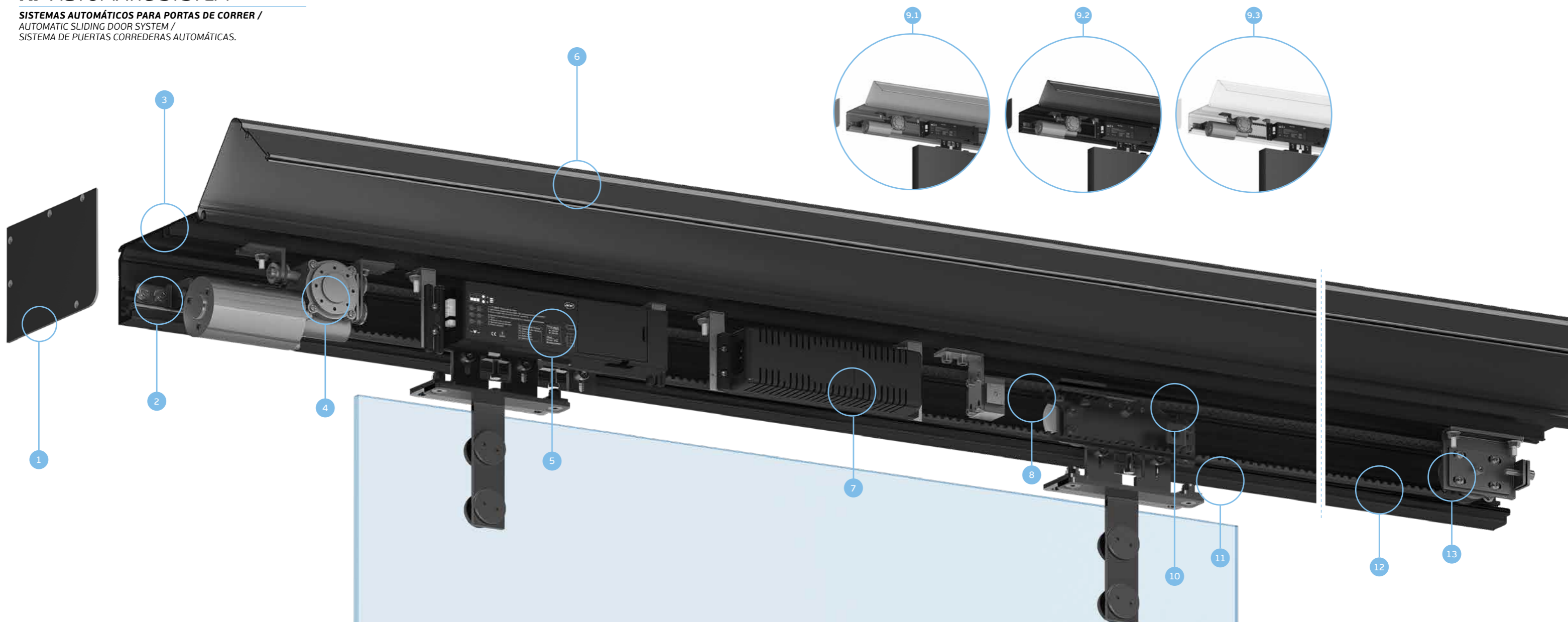
SISTEMAS AUTOMÁTICOS PARA PORTAS DE CORRER /
AUTOMATIC SLIDING DOOR SYSTEM /
SISTEMA DE PUERTAS CORREDERAS AUTOMÁTICAS.



1. Cobertura lateral /
Side cover / Cubierta lateral.

2. Batente ajustável /
Adjustable stopper /
Freno ajustable.

3. Carril superior /
Upper track / Carril superior.

4. Motor de correia /
Belt motor / Motor de correa.

5. Controlador /
Controller / Controlador.

6. Cobertura frontal /
Front cover / Cubierta frontal.

7. Transformador de corrente /
Current transformer /
Transformador de corriente.

8. E-LOCK

9. Calha de encaixe frontal /

Front locking track /
Carril de encaje frontal.

9.1. Standard INOX

9.2. RAL 9005

(sob consulta / under request /
por pedido)

9.3. RAL 9016

(sob consulta / under request /
por pedido)

10. Mordente da correia /

Belt cheek / Mordiente de la correa.

11. Roldanas ajustáveis /

Adjustable wheels / Ruedas ajustables.

12. Correia / Belt / Correa

13. Tensor da correia /

Belt tensor / Tensor da correa.

K7 AUTOMATIC SYSTEM

SISTEMAS AUTOMÁTICOS PARA PORTAS DE CORRER / AUTOMATIC SLIDING DOOR SYSTEM / SISTEMA DE PUERTAS CORREDERAS AUTOMÁTICAS.

BELT MOTOR ENGINE     FOR GLASS DOORS

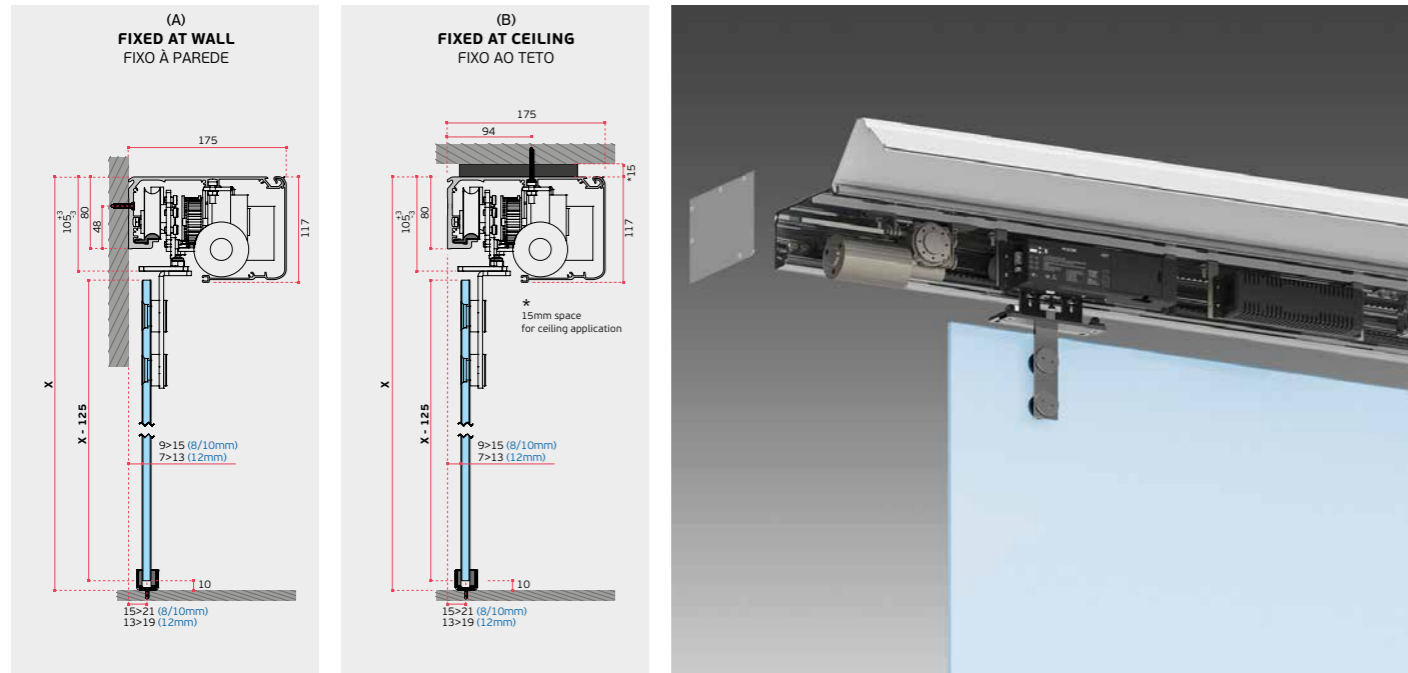

(A) FIXED AT WALL / FIXO À PAREDE

(B) FIXED AT CEILING / FIXO AO TETO

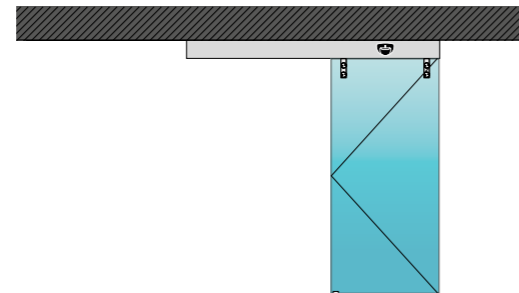
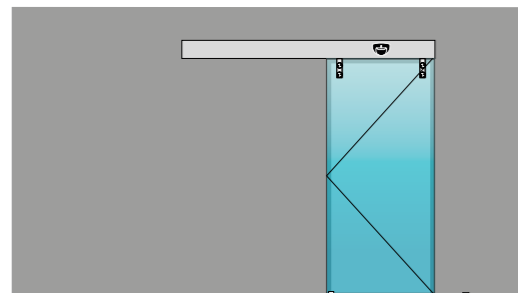

IN.15.782

- 2x Roldanas / Wheels / Ruedas
- 2x Batentes / Stoppers / Frenos
- 1x Guia de pavimento / Floor guide / Guiador de suelo
- Componentes eletrónicos / Electronic components / Componentes electrónicos.

IN.15.784.2/ IN.15.784.3
IN.15.784.4/ IN.15.784.6

- 1x Carril superior / Upper track / Carril superior (2000/3000/4000/6000mm).
- 2x Tampas / Covers / Cubierta

(A) FIXED AT WALL / FIXO À PAREDE

(B) FIXED AT CEILING / FIXO AO TETO

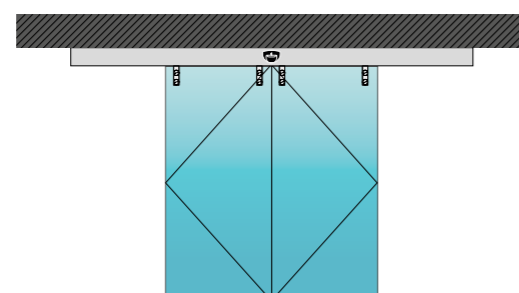
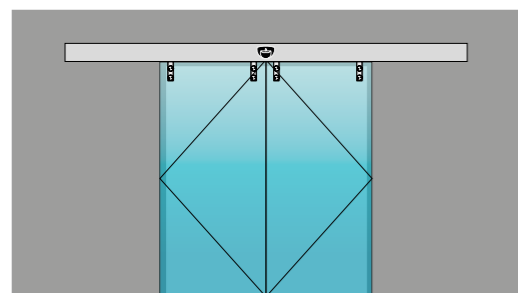

IN.15.783

- 4x Roldanas / Wheels / Ruedas
- 4x Batentes / Stoppers / Frenos
- 2x Guia de pavimento / Floor guide / Guiador de suelo
- Componentes eletrónicos / Electronic components / Componentes electrónicos.

IN.15.784.2/ IN.15.784.3
IN.15.784.4/ IN.15.784.6

- 1x Carril superior / Upper track / Carril superior (2000/3000/4000/6000mm).
- 2x Tampas / Covers / Cubierta

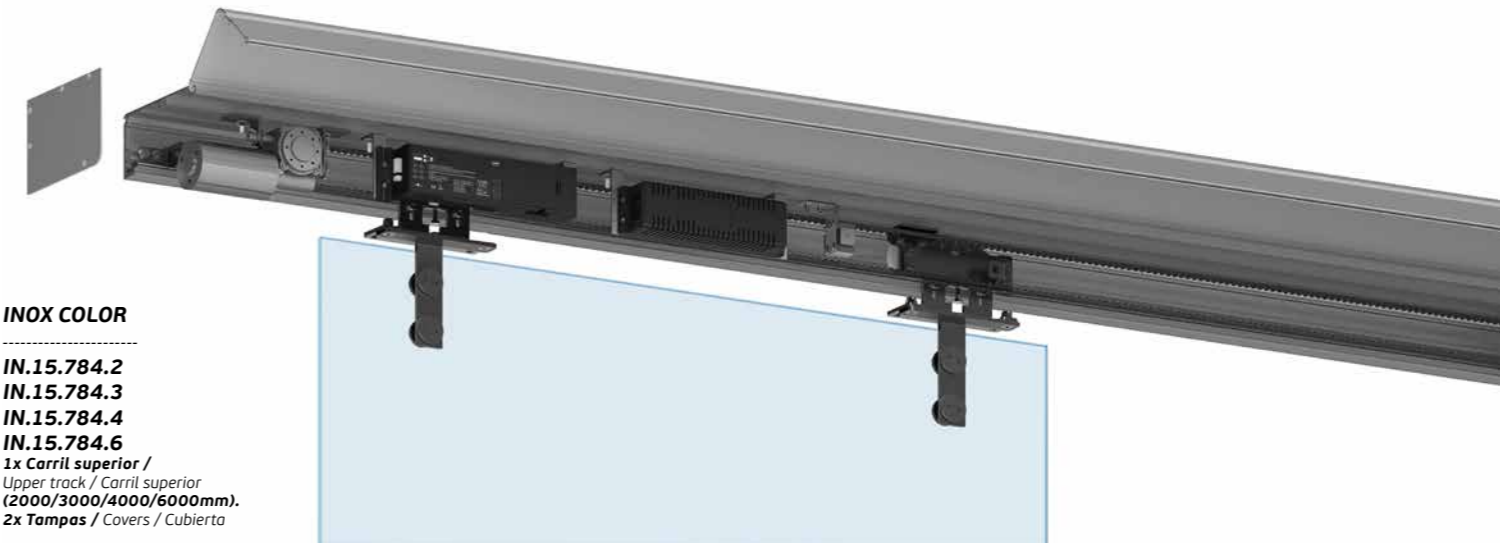

INOX COLOR

- IN.15.784.2
- IN.15.784.3
- IN.15.784.4
- IN.15.784.6
- 1x Carril superior / Upper track / Carril superior (2000/3000/4000/6000mm).
- 2x Tampas / Covers / Cubierta



BLACK RAL 9005

- IN.15.784.2.B
- IN.15.784.3.B
- IN.15.784.4.B
- IN.15.784.6.B
- 1x Carril superior / Upper track / Carril superior (2000/3000/4000/6000mm).
- 2x Tampas / Covers / Cubierta

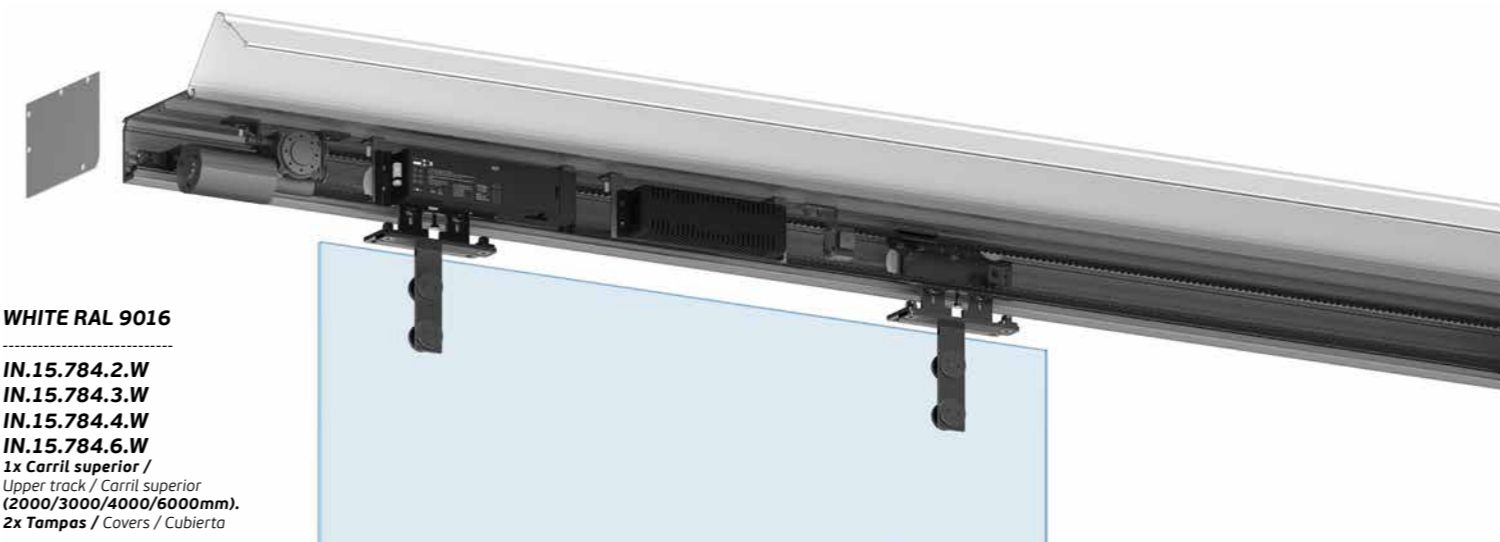

WHITE RAL 9016

- IN.15.784.2.W
- IN.15.784.3.W
- IN.15.784.4.W
- IN.15.784.6.W
- 1x Carril superior / Upper track / Carril superior (2000/3000/4000/6000mm).
- 2x Tampas / Covers / Cubierta

AUTOMATIC SYSTEM - LINEAR / MECANO / K7

SISTEMAS AUTOMÁTICOS PARA PORTAS DE CORRER /
 AUTOMATIC SLIDING DOOR SYSTEM /
 SISTEMA DE PUERTAS CORREDERAS AUTOMÁTICAS.

CARACTERÍSTICAS	LINEAR POLARIS	MECANO ELECTRON	K7
Peso máximo (porta simples) Max. door weight (single door) Peso máximo (puerta simple)	Min: 5kg Max: 80kg	Min: 20kg Max: 80kg	150kg
Peso máximo (porta dupla) Max. door weight (double door) Peso máximo (puerta doble)	2x 80kg	---	2x 140kg
Largura máxima da porta (mm) Max. door width (mm) Ancho máximo de la puerta (mm)	1500	1100	1300
Largura mínima da porta (mm) Minimum door width (mm) Ancho mínimo de la puerta (mm)	950 (e-lock) 900 (standard)	---	700
Tipo de motor / tração Motor type / drive Tipo de motor / tracción	Motor linear c/ ímanes permanentes Linear motor with permanent magnets Motor linear c/ ímanes permanentes	Motor eléctrico de correia Belt electric motor Motor eléctrico de correia	Motor eléctrico de correia Belt electric motor Motor eléctrico de correia
Nível de ruído Noise level Nivel de ruído	<50 dB	Max: 55 dB	Máx: 75 dB
Tipos de porta Door types: Tipos de puerta:	Vidro / Madeira / Metal Glass / Wood / Metal	Vidro / Madeira / Metal Glass / Wood / Metal	Vidro / Madeira / Metal Glass / Wood / Metal
Espessura de porta (mm) Door thickness (mm) Espesor de puerta (mm)	Vidro / Glass / cristal: 8-10 Madeira / Timber / Madera: >30	Vidro / Glass / cristal: 8-10 Madeira / Timber / Madera: >30	Vidro / Glass / cristal: 8-12 Madeira / Timber / Madera: 30-60
Min. espaço à parede (portas de vidro) Min. gap to wall (glass door) Min. espacio a la pared (puerta cristal)	33mm	18mm	9mm
Min. espaço à parede (porta 35mm) Min. gap to wall (door 35mm) Min. espacio a la pared (puerta 35mm)	5mm	17mm	12mm
Opções de montagem Mounting options Opciones de montaje	Parede / teto / vidro Wall / Ceiling / Glass Pared / Techo / Cristal	Parede / teto / vidro Wall / Ceiling / Glass Pared / Techo / Cristal	Parede / teto Wall / Ceiling Pared / Techo
Fonte de energia Power supply Fuente de energía	230 VCA / 100 VCA - 50/60 Hz CE	230 VCA / 100 VCA - 50/60 Hz CE	230 VCA / 110 VCA - 50/60 Hz CE
Dispositivos de ativação (standard) Activation devices (standard) Dispositivos de activación (standard)	Push and go / Controlo remoto Push and go / Remote control Push and go / Controlo remoto	Push and go Push and go Push and go	Controlo remoto Remote contro Controlo remoto
Dispositivos opcionais de ativação Activation optional devices Dispositivos opcionales de activación	Botão mágico / Magic button Sensor de movimento / Motion sensor Mifare Teclado numérico / Keypad Push button	Botão mágico / Magic button Sensor de movimento / Motion sensor Mifare Teclado numérico / Keypad Push button	Botão mágico / Magic button Sensor de movimento / Motion sensor Mifare Teclado numérico / Keypad Push button
Opções de segurança Security options Opciones de seguridad	Pino eletromagnético / Fotocélula Electromagnetic pin / Photocell Pin electromagnético / Célula fotoelétrica	Fotocélula Photocell Célula fotoelétrica	Pino eletromagnético / Fotocélula Electromagnetic pin / Photocell Pin electromagnético / Célula fotoelétrica

CARACTERÍSTICAS	LINEAR POLARIS	MECANO ELECTRON	K7
Opções de cores Color options Opciones de color	Preto / Black / Negro: RAL 9005 Prata / Silver / Plata: RAL 9006 Branco / White / Blanco: RAL 9016 Outro / Other / Otro: RAL _____	Preto / Black / Negro: RAL 9005 Prata / Silver / Plata: RAL 9006 Branco / White / Blanco: RAL 9016 Outro / Other / Otro: RAL _____	Preto / Black / Negro: RAL 9005 Prata / Silver / Plata: RAL 9006 Branco / White / Blanco: RAL 9016 Outro / Other / Otro: RAL _____
Dimensões de carril (mm) Track dimensions (mm) Dimensiones de carril (mm)	2000/3000 (single) 4000/6000 (double)	2000	2000/3000 4000/6000
Ajuste da altura da porta (mm) Door height adjustment (mm) Ajuste de la altura de la puerta (mm)	+2,5 / -2,5	+2 / -2	+3 / -3
Corrosão EN 1670 Corrosion EN 1670 Corrosión EN 1670	Classe 2	Classe 2	Classe 2
Ciclos de porta Door cycles Ciclos de puerta	1.000.000	500.000	1.000.000
Certificações Certifications Certificaciones	Directive 2006/42/CE EN ISO 12100:2012 EN ISO 13857:2008 Directive 2004/108/CE (EMC) EN 61000-3-2:2006 + A1:2011 EN 61000-3-3:2008 EN 61000-6-1:2007 EN 61000-6-3:2007+A1:2011 Directive 2004/95/CE Safety UNE EN 60335-1:2012+A11:2014	EN 16005 EN ISO 12100:2012 EN ISO 13849 EN 61000-6-1 EN 61000-6-2 EN 61000-6-3 EN 61000-6-4 Compatibilidade / Compatibility UNE EN 60335-1 / 2 UNE EN 60335-2 -103	EN
Tipo de ajuste Adjustment type Tipo de ajuste puerta	Por números digitais By digital numbers Por números digitales	Por números digitais By digital numbers Por números digitales	Por dip switch By dip switch Por dip switch
Preparação da porta vidro Glass door preparation Preparación puerta cristal	Necessita entalhe (GC_) Needs cutout (GC_) Necesita taladro (GC_)	Não necessita entalhe No cutout No necesita taladro	Necessita entalhe (GC_) Needs cutout (GC_) Necesita taladro (GC_)
Versão síncro Synchro option Versión Synchro	Disponível Available Disponible	Não disponível Not available No disponible	Disponível Available Disponible
Indicador de modo Status indicator Indicador de modo	Sim (LED) Yes (LED) Si (LED)	Sim Yes Si	Sim Yes Si
Fecho automático Self-closing Cierre automático	Sim Yes Si	Sim Yes Si	Sim Yes Si
Perfil pré-perfurado Pre-drilled track Perfil pre-perforado	Sim Yes Si	Não No No	Não No No

CONCIERGE AUTOMÁTICO AUTOMATIC CONCIERGE / CONSERJE AUTOMATICO



TOUCH
LESS



O **CONCIERGE** automático é um activador de porta basculante de batente, especialmente desenvolvido para auxiliar no processo de abertura de portas.

Pode ser acionado de forma totalmente automática (radar ou interruptor TOUCHLESS) ou por toque (função TOUCH TO OPEN, botão de pressão ou controlo remoto).

A JNF tem uma vasta gama de acessórios disponíveis e adequados para completar todas as funções necessárias:

- Portas metálicas, madeira ou vidro
- Diferentes opções de braço (padrão/deslizante)
- Radares de proximidade
- Interruptor TOUCHLESS (wireless ou com ligação por cabo)
- Interruptor normal
- Opções de bloqueio eletromagnético
- Opções de controlo de acesso

O **CONCIERGE** automático está em total conformidade com o DDA (recomendado para pessoas com mobilidade reduzida) e como pode ser operado sem nenhum contacto, é uma solução perfeita em termos de conforto e higiene.

The automatic **CONCIERGE** is a single swing door operator, specially developed to assist the door opening process.

It can be triggered fully automatically (radar or TOUCHLESS switch) or with low force touch (TOUCH TO OPEN function, pressure button or remote control).

JNF has a wide range of accessories available and suitable to complete all the required functions:

- Metallic, wood or glass doors
- Different arm options (standard / sliding)
- Proximity radars
- TOUCHLESS switch (wireless or wired)
- Normal switch
- Electromagnetic lock options
- Access control options

The automatic **CONCIERGE** is fully compliant with the DDA (disable discrimination act) and as it can be operated without any contact it is a perfect solution in terms of comfort and hygiene.

El **CONSERJE** automático es un activador de puerta basculante de batiente, especialmente desarrollado para ayudar en el proceso de apertura de la puerta.

Se puede activar de forma totalmente automática (radar o interruptor TOUCHLESS) o táctil (función TOUCH TO OPEN, pulsador o mando a distancia).

JNF dispone de una amplia gama de accesorios adecuados para completar todas las funciones necesarias:

- Puertas de metal, madera o cristal
- Diferentes opciones de brazo (estándar / deslizador)
- Radar de proximidad
- Interruptor TOUCHLESS (inalámbrico o con cable)
- Interruptor normal
- Opciones de bloqueo electromagnético
- Opciones de control de acceso

El **CONSERJE** automático cumple totalmente con la DDA (recomendado para personas con movilidad reducida) y como se puede operar sin ningún contacto, es una solución perfecta en términos de comodidad e higiene.



RAL
9006

RAL
9016

RAL
9005



AUTOMATIC CONCIERGE

ACTIVADOR DE PORTA BASCULANTE DE BATENTE, ESPECIALMENTE DESENVOLVIDO PARA AUXILIAR NO PROCESSO DE ABERTURA DE PORTAS. / SIGLE SWING DOOR OPERATOR, SPECIALLY DEVELOPED TO ASSIST THE DOOR OPENING PROCESS.
ACTIVADOR DE PUERTA BASCULANTE DE BATIENTE, ESPECIALMENTE DESARROLLADO PARA AYUDAR EN EL PROCESO DE APERTURA DE LA PUERTA.

CONCIERGE AUTOMÁTICO

AUTOMATIC CONCIERGE / CONSERJE AUTOMATICO

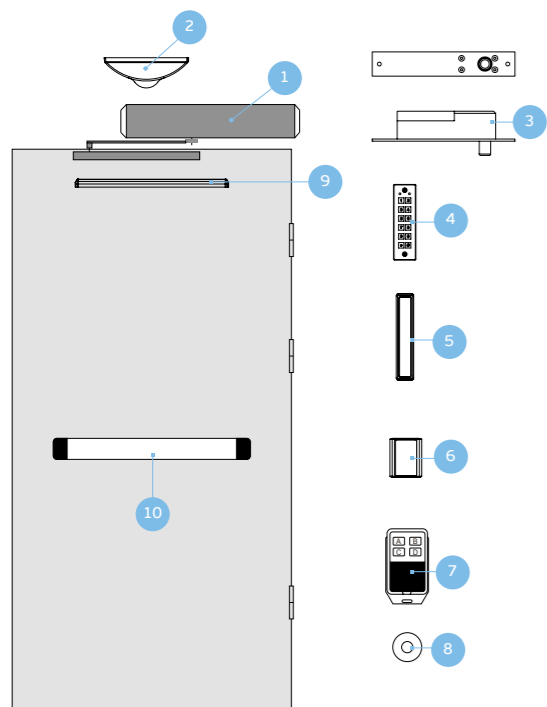

1. Mecanismo de porta /
Swing door mechanism / Mecanismo de puerta
2. Sensor de microondas /
Microwave sensor / Sensor de microondas
3. E-LOCK / E-LOCK / E-LOCK
4. Teclado numérico /
Number keypad / Teclado numerico
5. Botão wireless PUSH /
Push button wireless / Botón wireless PUSH
6. Sensor TOUCHLESS /
TOUCHLESS sensor / Sensor TOUCHLESS
7. Controlo remoto /
Remote control / Control remoto
8. Botão PUSH / Push button / Botón PUSH
9. Sensor de topo / Top sensor / Sensor superior
10. Barra switch / Switch push bar / Barra switch.

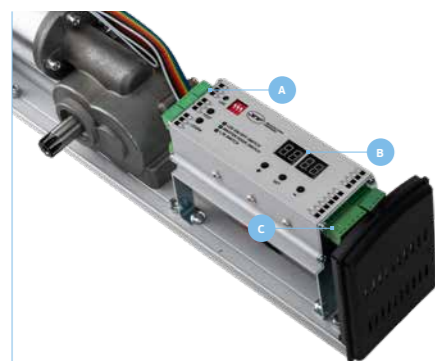

- A. Controlador / Controller / Controlador**
B. Display digital /
Digital display / Pantalla digital
C. Ligação de fios /
Wiring connections / Conexiones.

- | | |
|---------------|-----------------------------|
| 1 - +24V | 13 - SYNCHRONOUS (IN) |
| 2 - GND | 14 - INTERLOCK (OUT) |
| 3 - +12V | 15 - COM |
| 4 - GND | 16 - INTERLOCK (IN) |
| 5 - OPEN - A | 17 - E-LOCK + |
| 6 - COM | 18 - GND |
| 7 - FULL LOCK | 19 - UPS + |
| 8 - COM | 20 - +24V |
| 9 - OPEN - B | 21 - +12V |
| 10 - COM | 22 - GND |
| 11 - SYNCHRO | 23 - ANTI-COLLISION (CLOSE) |
| 12 - COM | 24 - ANTI-COLLISION (OPEN) |

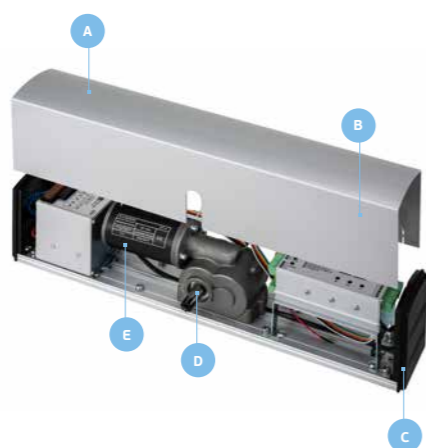

- A. RAL 9006 (standard);**
Outros acabamentos RAL disponíveis /
RAL 9006 (standard); other RAL finishes available /
RAL 9006 (estándar); otros acabados RAL disponibles
B. Cobertura em alumínio reforçado /
Aluminium reinforced cover /
Cubierta reforzada de aluminio
C. Cobertura ABS /
ABS covers / Cubiertas ABS

- D. Quadra em aço inox para o braço standard ou**
deslizante / Stainless steel spindle for standard or sliding
arm / Cuadra de acero inoxidable para brazo estándar o
corredizo.
E. Motor brushless (24V-55W) /
Brushless motor (24V-55W) /
Motor sin escobillas (24V-55W)

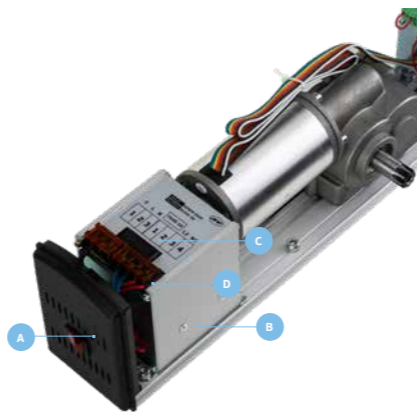

- A. Interruptor ON-OFF /**
ON-OFF switch /
Interruptor ON-OFF
B. Fonte de alimentação AC90-250V; DC24V,
3A / Power supply AC90-250V; DC24V, 3A /
Fuente de alimentación AC90-250V; DC24V, 3A
C. Fusível de protecção 3A /
Protection fuse 3A / Fusible de protección 3A
D. Ligação de fios /
Wiring connections / Conexiones de cableado

IN.21.900 RAL 9006
IN.21.900.W RAL 9016
IN.21.900.B RAL 9005



- A ALWAYS OPEN**
B AUTOMATIC
C OPEN/CLOSE ONE TIME
D FULL LOCK/EXIT ONLY

Activador de porta basculante de batente simples
adequado para portas de madeira, metal e vidro
(com abertura simples ou dupla). Baixo ruído,
desempenho confiável, Display digital /

Tamanho: 515x80x115mm
Peso: 8kg
Largura da porta: 1600mm (máx.)
Peso da porta: 140kg (máx.)
Temperatura de trabalho: -20°C ~ +50°C
Tensão de entrada: AC 90-250V
Voltagem de saída: 24V DC (% 10%) - 3A
Grau de abertura: máx. 115° (ajustável)
Velocidade abrir/fechar: 45°/s
Tempo de abertura: 0-60 segundos (ajustável)
Vidro de protecção: IP21
Função push&go
Transformador certificado: 90V/250V - 50W
1000000 ciclos

Single swing door operator suitable for wooden,
metal and glass doors (both single or double open).
Low noise, reliable performance,
digital display /

Size: 515x80x115mm
Weight: 8kg
Door width: 1600mm (máx.)
Door weight: 140kg (máx.)
Working temperature: -20°C ~ +50°C
Input voltage: AC90 - 250V
Output voltage: 24V DC (% 10%) - 3A
Open degree: máx. 115° (adjustable)
Open/close speed: 45° / s (adjustable)
Opening time: 0 - 60 seconds (adjustable)
Protection class: IP21
Function push&go
Certified transformer: 90v/250V - 50W
1000000 cycles

Activador de puerta basculante de batiente simple
apto para puertas de madera, metal y cristal (con
apertura simple o doble). Bajo ruido, rendimiento
fiable, pantalla digital.

Talla: 515x80x115mm
Peso: 8kg
Ancho de puerta: 1600mm (máx.)
Peso puerta: 140 kg (máx.)
Temperatura de trabajo: -20°C ~ +50°C
Voltaje de entrada: AC 90 - 250V
Tensión de salida: 24V DC (% 10%) - 3A
Grado abierto: máx. 115° (ajustable)
Velocidad abrir/cerrar: 45° / s
Tiempo de apertura: 0 - 60 segundos (ajustable)
Grado de protection: IP21
Función push&go
Transformador certificado: 90V/250V - 50W
1000000 ciclos

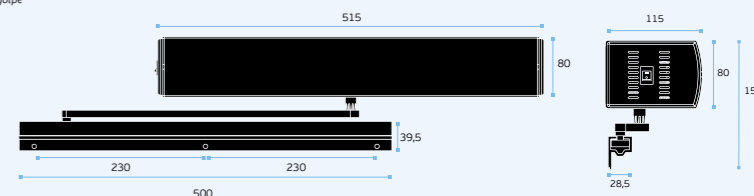
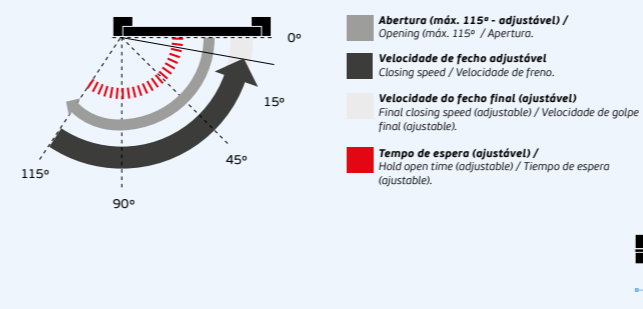

CONCIERGE AUTOMÁTICO

AUTOMATIC CONCIERGE / CONSERJE AUTOMATICO



IN.21.902.B STAINLESS STEEL

Braço standard ajustável para IN.21.900 /
Standard adjustable arm for IN.21.900 /
Braço ajustable estándar para IN.21.900.

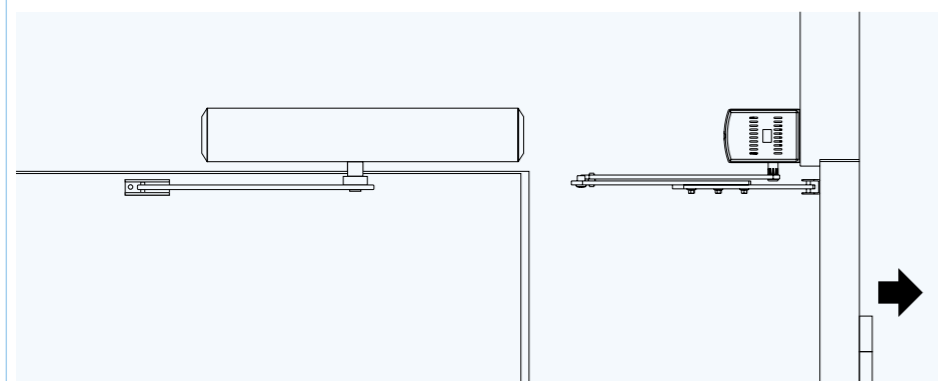

IN.21.903

Pinça para vidro para braço IN.21.902.B /
Glass clamp for arm IN.21.902.B /
Base para cristal para IN.21.902.B.

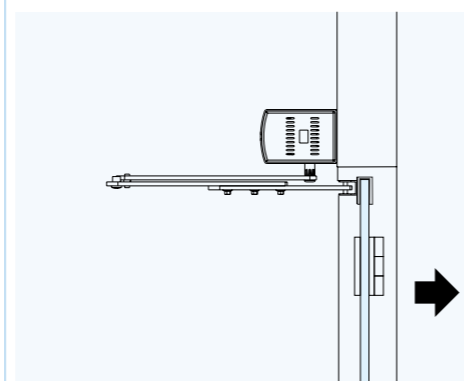

RAL
9006

IN.21.902.C RAL 9006

Braço deslizante em alumínio para portas de vidro /
Aluminium sliding arm for glass doors /
Braço deslizante en aluminio para puertas de cristal.



RAL
9005

IN.21.902.C.B RAL 9005

Braço deslizante em alumínio para portas de vidro /
Aluminium sliding arm for glass doors /
Braço deslizante en aluminio para puertas de cristal.



RAL
9016

IN.21.902.C.W RAL 9016

Braço deslizante em alumínio para portas de vidro /
Aluminium sliding arm for glass doors /
Braço deslizante en aluminio para puertas de cristal.

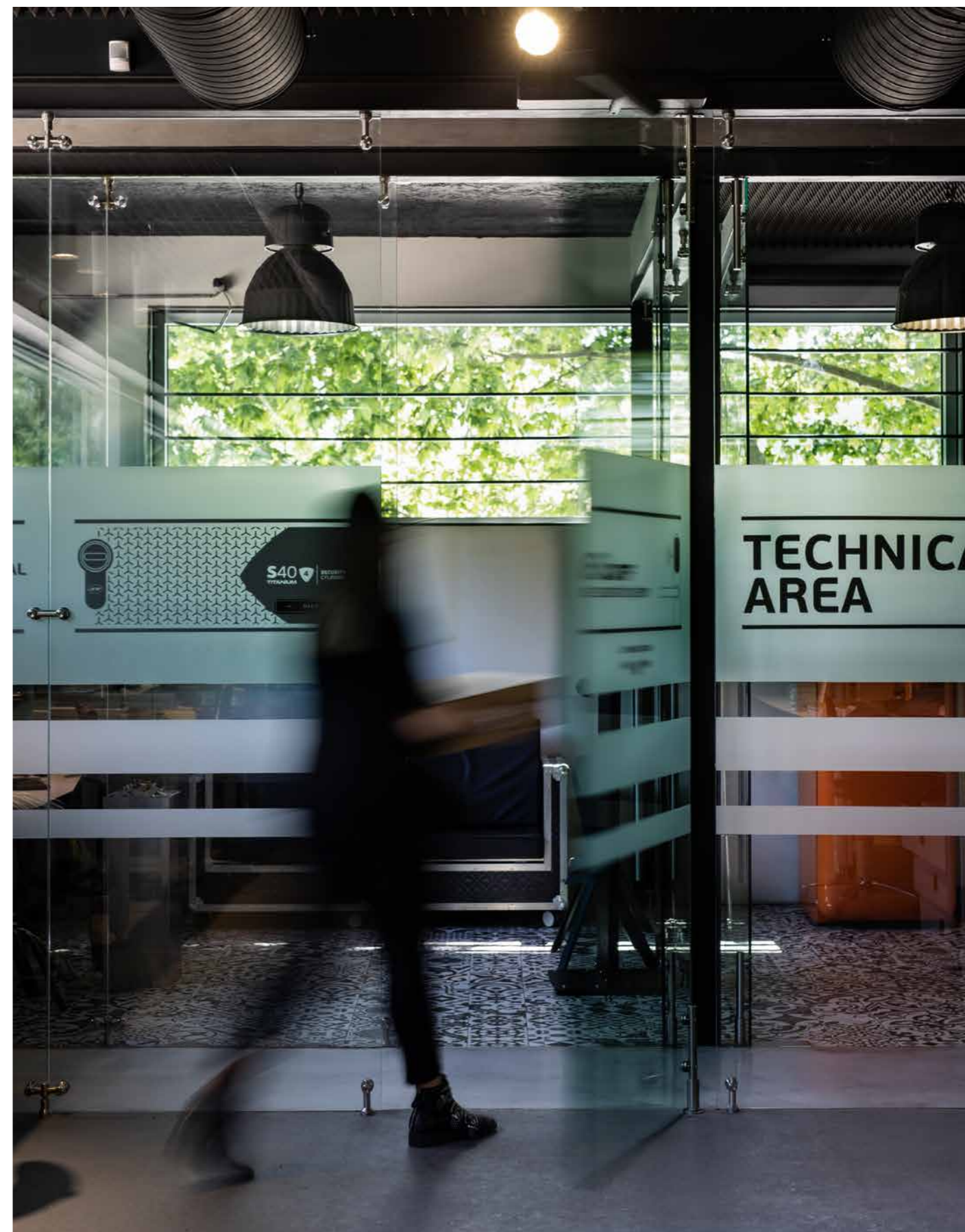
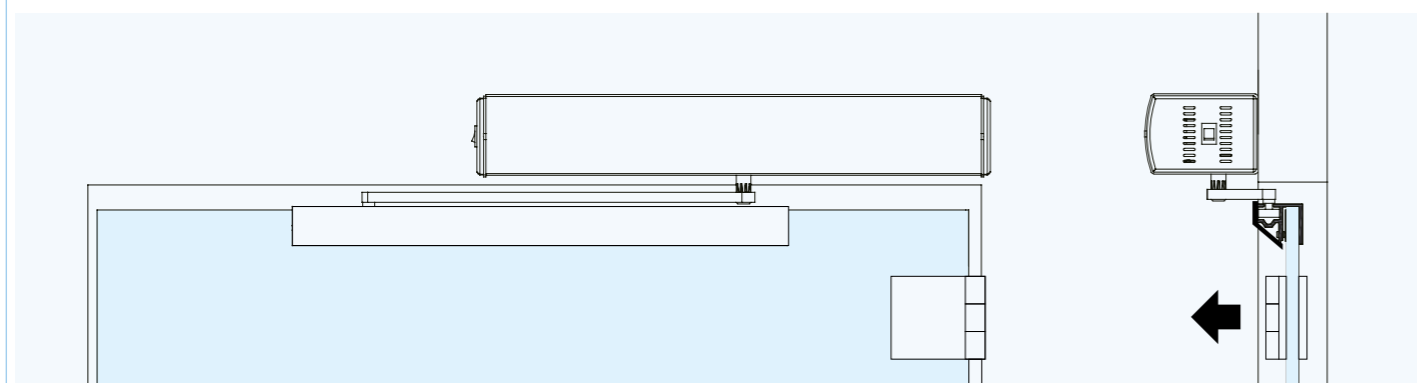

ACESSÓRIOS PERIFÉRICOS / PERIPHERAL ACCESSORIES / ACCESORIOS PERIFÉRICOS

IN.21.910

**Interruptor TOUCHLESS
com cabo / TOUCHLESS
switch with cable /
Interruptor TOUCHLESS con
cable**



IN.21.910.WL

**Interruptor TOUCHLESS
sem fios /
Wireless TOUCHLESS switch /
Interruptor TOUCHLESS sin
cable**

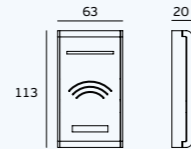
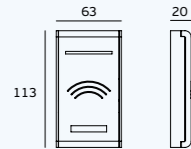

IN.21.910.RC

**Receptor para IN.21.910.WL
e IN.15.732 /
Receiver for IN.21.910.WL
and IN.15.732 /
Receptor para IN.21.910.WL
y IN.15.732**

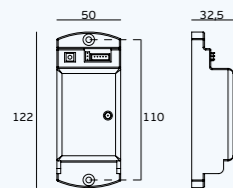

Fonte de alimentação /
Power supply
Fuente de alimentación

AC/DC 12 ~ 36V

Consumo energia /
Power consumption
Consumo de energia

15 mA

Corrente /
Power current
Corriente

80 mA (DC 12V)

Capacidade relay /
Relay contact capacity
Capacidad relay

20 A 14 VDC

IN.15.732

**Botão wireless /
Wireless button /
Botón wireless**

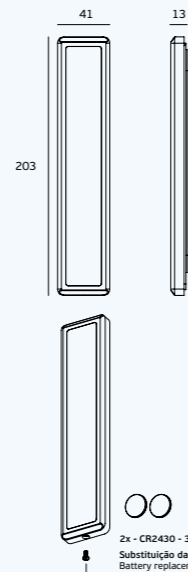

2x - CR2430 - 3V
Substituição das pilhas /
Battery replacement /
Reemplazo de las baterías



TOUCHLESS SWITCH

**O INTERRUPTOR SEM TOQUE É IDEAL PARA ÁREAS
ONDE OS REQUISITOS SANITÁRIOS SÃO IMPORTANTES,
COMO HOSPITAIS E UNIDADES DE SAÚDE.**
THE TOUCHLESS SWITCH IS IDEAL FOR AREAS WHERE
SANITARY REQUIREMENTS ARE CRITICAL SUCH AS
HOSPITALS AND HEALTH CARE FACILITIES.
EL INTERRUPTOR SIN CONTACTO ES IDEAL PARA ÁREAS
DONDE LOS REQUISITOS SANITARIOS SON IMPORTANTES,
COMO HOSPITALES Y CENTROS DE ATENCIÓN MÉDICA.



TOUCH
LESS



WIRELESS

ACESSÓRIOS PERIFÉRICOS / PERIPHERAL ACCESSORIES / ACCESORIOS PERIFÉRICOS



IN.28.108

Controlo de acesso autónomo com teclado numérico.
 Auto-programável
 Corrente de entrada 12 VDC.
 Saída para diferentes periféricos NC/NO.
 Parafusos de segurança.
 Caixa estanque; IP65
 Configuração de vários usuários.
 Max input 60mA
 Standby input 25mA /
 145x43x10mm /



IN.28.108.B

Standalone access control with number keypad.
 Self programming system.
 Power input 12VDC.
 Output to different peripherals NC/NO.
 Security screws.
 Waterproof box; IP65
 Possible to install different users.
 Max input 60mA
 Standby input 25mA/
 145x43x10mm /

IN.28.108.5
 Parafusos de segurança /
 Security screws /
 Tornillos de seguridad.



IN.28.109

Controlo de acesso autónomo com teclado numérico.
 Auto-programável.
 Corrente de entrada 12 VDC.
 Saída para diferentes periféricos NC/NO.
 Parafusos de segurança.
 Caixa estanque; IP65
 Configuração de vários usuários. Ligação de sensor de porta. Saída auxiliar para alarme. Com luz LED.
 Max input 85mA
 Standby input 25mA
 120x80x25mm

Standalone access control with number keypad.
 Self programming system.
 Power input 12VDC.
 Output to different peripherals NC/NO.
 Security screws.
 Waterproof box; IP65
 Possible to install different users.
 Doors status.
 Output to alarm.
 LED light
 Max input 85mA
 Standby input 25mA
 120x80x25mm

Controlo de acesso autónomo com teclado numérico. Autoprogramável.
 Corrente de entrada 12VDC.
 Salida para distintos periféricos NC/NO.
 Tornillos de seguridad.
 Caja contra la intemperie.
 Posible de configurar distintos usuarios.
 Sensor de puerta.
 Salida para alarme.
 Luz LED
 Max input 85mA
 Standby input 25mA
 120x80x25mm



IN.24.201

Interruptor / Switch / Interruptor. MÁX: 12 VOLTS

MATERIAL: EN 1.4301 / AISI 304

ACABAMENTO / FINISH / ACABADO: SATINADO / SATIN

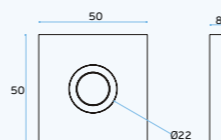

IN.24.204

Interruptor / Switch / Interruptor. MÁX: 12 VOLTS

MATERIAL: EN 1.4301 / AISI 304

ACABAMENTO / FINISH / ACABADO: SATINADO / SATIN

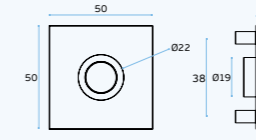

IN.24.205

Interruptor / Switch / Interruptor. MÁX: 12 VOLTS

MATERIAL: EN 1.4301 / AISI 304

ACABAMENTO / FINISH / ACABADO: SATINADO / SATIN

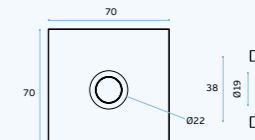

IN.24.203

Interruptor / Switch / Interruptor. MÁX: 12 VOLTS

MATERIAL: EN 1.4301 / AISI 304

ACABAMENTO / FINISH / ACABADO: SATINADO / SATIN

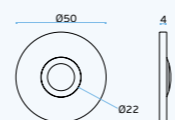

IN.24.207

Interruptor / Switch / Interruptor. MÁX: 12 VOLTS

MATERIAL: EN 1.4301 / AISI 304

ACABAMENTO / FINISH / ACABADO: SATINADO / SATIN

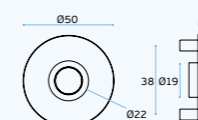

IN.24.208

Interruptor / Switch / Interruptor. MÁX: 12 VOLTS

MATERIAL: EN 1.4301 / AISI 304

ACABAMENTO / FINISH / ACABADO: SATINADO / SATIN

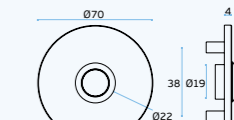

IN.24.202

Interruptor / Switch / Interruptor. MÁX: 12 VOLTS

MATERIAL: EN 1.4301 / AISI 304

ACABAMENTO / FINISH / ACABADO: SATINADO / SATIN

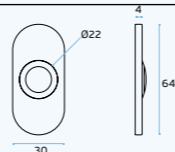

IN.24.206

Interruptor / Switch / Interruptor. MÁX: 12 VOLTS

MATERIAL: EN 1.4301 / AISI 304

ACABAMENTO / FINISH / ACABADO: SATINADO / SATIN

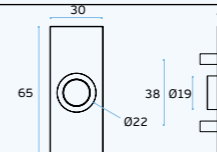

IN.24.209

Interruptor / Switch / Interruptor. MÁX: 12 VOLTS

MATERIAL: EN 1.4301 / AISI 304

ACABAMENTO / FINISH / ACABADO: SATINADO / SATIN

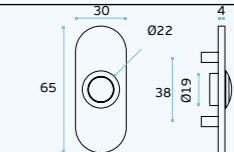

SISTEMAS DE CONTROLO DE ACESSOS / ACCESS CONTROL SYSTEMS / SISTEMAS DE CONTROL DE ACCESOS.

2in1

IN.15.730

Sensor de dupla acção, radar de proximidade
microondas, barreira de protecção.
Altura montagem: 2m ~ 3,5m
IP: IP54

Saída de sinal: NO / NC
Corrente standby: 70ma (12v)
Corrente de trabalho: 78ma (12v)
Peso: 230g
Temperatura de operação: -20°C ~ +55°C
Fonte de alimentação AC/DC: 12-24v
Tempo de aprendizagem: 15 segundos
Sensor infravermelho: 850mm
Ângulo de profundidade: -6° ~ +6°
Tempo de espera de saída: 1 segundo
Tempo de resposta: <0,3 segundos
Sensor microondas: 24.125 ghz
Ângulo de profundidade: 25° ~ 45°

Double action sensor, microwave proximity radar,
protection barrier.
Assembly height: 2m ~ 3,5m
IP: IP54

Signal exit: NO / NC
Standby chain: 70mA (12V)
Working current: 78mA (12V)
Weight: 230g
Operating temperature: -20°C ~ +55°C
Power supply: AC/DC 12-24v
Learning time: 15 seconds
Infrared sensor: 850mm
Depth angle: -6° ~ +6°
Exit waiting time: 1 second
Response time: <0,3 seconds
Microwave sensor: 24.125 ghz
Depth angle: 25° ~ 45°

Sensor de doble acción, radar de proximidad de
microondas, barrera de protección.
Altura de montaje: 2m ~ 3,5m
IP: IP54

Señal salida: NO / NC
Cadena de espera: 70mA (12V)
Corriente de trabajo: 78mA (12V))
Peso: 230g
Temperatura de funcionamiento: -20°C ~ +55°C
Fuente de alimentación: AC/DC 12-24v
Tiempo de aprender: 15 seconds
Sensor infrarojo: 850mm
Ángulo de profundidad -6° ~ +6°
Salir del tiempo de espera: 1 second
Tiempo de respuesta: <0,3 seconds
Sensor de microondas: 24.125 ghz
Ángulo de profundidad: 25° ~ 45°



BARREIRA DE PROTECÇÃO

PROTECTION BARRIER / BARRERA DE PROTECCIÓN

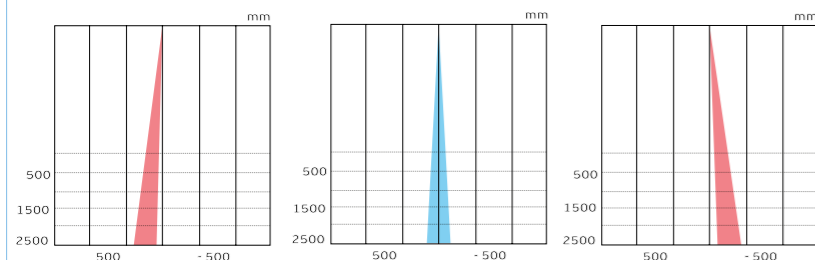

RADAR DE PROXIMIDADE

PROXIMITY RADAR / RADAR DE PROXIMIDAD

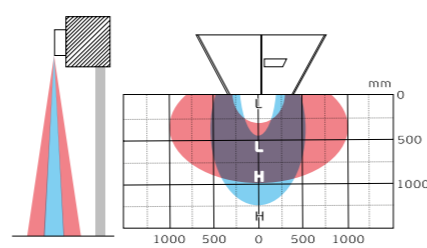

IN.15.731

Radar de proximidade microondas
Fonte de alimentação: AC / DC 12-24V
Altura de montagem: 4 Mt
Sensor de microondas: 24.125 Ghz
Ângulo profundidade: 0° ~ 60°
Ângulo lateral: 0,60 ~ 60°
Cor: Preto - RAL 9005.

Microwave proximity radar.
Power Supply: AC / DC 12-24V
Assembly height: 4 Mt
Microwave sensor: 24.125 Ghz
Deep angle: 0° ~ 60°
Side angle: .60 ~ 60°
Color: Black - RAL 9005/

Radar de proximidad de microondas
Fuente de alimentación: AC/DC 12-24V
Altura de montaje: 4 Mt
Sensor de microondas: 24.125 Ghz
Ángulo profundo: 0° ~ 60°
Ángulo lateral: .60 ~ 60°
Color: Negro - RAL 9005

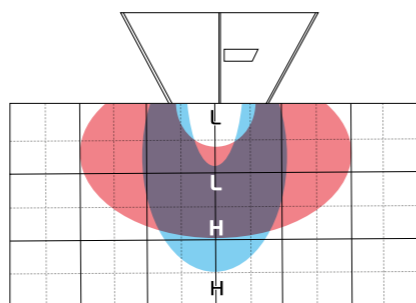
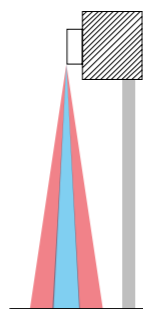

IN.15.737

Sensor de topo, barreira de protecção.

Altura de montagem: 1,5m ~ 3m
IP: IP54
Método de detecção: triangulação
Ângulo de profundidade: 0° ~ +25°
Corrente de trabalho: 1,3 - 3,5W
Indicador led: sim
Temperatura de operação: -20°C ~ +55°C
Fonte de energia: AC/DC 12-24V
Tempo de resposta: < 75 m/seg
Humidade de operação: < 80%
Tempo de espera de saída: aprox. 0,5 segundos
Nível de ruído: <70 DbA
Categoria: EN ISO 13849-1
Nível de performance: EN ISO 13849-1
Certificação: EN 16005

Top scan, protection barrier.

Assembly height: 1,5m ~ 3m
IP: IP54
Detection method: triangulation
Depth angle: 0° ~ +25°
Working current: 1,3 - 3,5W
LED indicator: yes
Operating temperature: -20°C ~ +55°C
Power supply: AC/DC 12-24V
Response time: < 75 m/seg
Operation humidity: < 80%
Output hold time: aprox. 0,5 seconds
Noise level: <70 DbA
Category: EN ISO 13849-1
Performance level: EN ISO 13849-1
Certification: EN 16005

Sensor de topo, barreira de protecção.

Altura de montaje: 1,5m ~ 3m
IP: IP54
Método de detección: triangulación
Ángulo de profundidad: 0° ~ +25°
Corriente de trabajo: 1,3 - 3,5W
Indicador led: si
Temperatura de funcionamiento: -20°C ~ +55°C
Fuente de alimentación: AC/DC 12-24V
Tiempo de respuesta: < 75 m/seg
Humedad de funcionamiento: < 80%
Tiempo de mantenimiento de salida: aprox. 0,5 segundos
Nivel de ruido: <70 dba
Categoría: EN ISO 13849-1
Nivel de desempeño: EN ISO 13849-1
Certificación: EN 16005

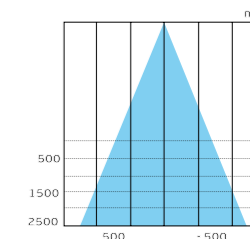
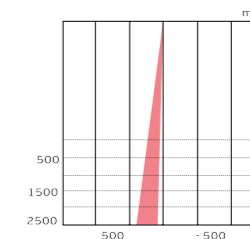

PROXIMITY SENSORS

ELEMENTOS DE SEGURANÇA QUE GARANTEM UMA ATUAÇÃO
CORRETA DO SISTEMA QUANDO ALGUÉM SE APROXIMA.
SECURITY ELEMENTS THAT GUARANTEE A CORRECT ACTION OF
THE SYSTEM WHEN SOMEONE IS APPROACHING.
ELEMENTOS DE SEGURIDAD QUE GARANTIZAN UNA CORRECTA
ACTUACIÓN DEL SISTEMA CUANDO ALGUIEN SE ACERCA.

DISPOSITIVOS ELECTROMAGNÉTICOS / ELECTROMAGNETIC DEVICES / DISPOSITIVOS ELECTROMAGNETICOS.



IN.28.690

- Fechadura eletromagnética**
- Corpo em alumínio anodizado
- Sem magnetismo residual
- Força de retenção de 500kg
- Baixo consumo de 0,7A para 12 VDC e 0,35A para 24 VDC
- LED para controle de posição da porta
- Tratamento Anti-corrosão
- Aplicável em temperaturas de -60 a +80 °C
- Projetado para alimentação de 12 V ou 24 V DC
- Disponíveis vários acessórios de fixação.

- Electromagnetic Lock**
- Body made in anodized aluminum
- No residual magnetism
- Holding force of 500kg
- Low consumption 0,7A for 12 VDC and 0,35A for 24 VDC
- Led light for door control
- Anti-corrosion protected
- Suitable for temperatures between -60 and +80°C
- Designed for connection to 12 V or 24 V DC supplies
- Available several different fixing accessories

- Cerradura electromagnética**
- Cuerpo en aluminio anodizado
- Sin magnetismo residual
- Fuerza de sujeción de 500kg
- Bajo consumo de 0,7A para 12 VDC y 0,35A para 24 VDC
- Led indicador de posición de la puerta
- Tratamiento anti-corrosión
- Aplicable en temperaturas desde -60 hasta 80 ° C
- Diseñado para conexión de 12 V o 24 V DC
- Varios accesorios de montaje disponibles.

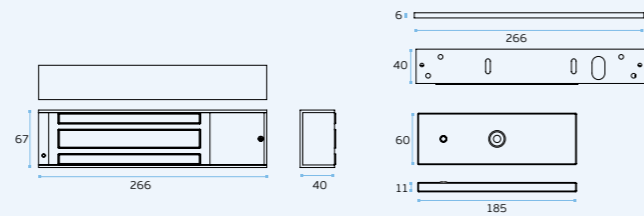

EN 50081-1/1992:EN 55014
EN 500 82-1/1997: EN 55015-2



IN.28.691

- Fechadura eletromagnética para 2 folhas**
- Corpo em alumínio anodizado
- Sem magnetismo residual
- Força de retenção de 500kg por folha.
- Baixo consumo de 0,7A para 12 VDC e 0,35A para 24 VDC
- LED para controle de posição da porta
- Tratamento Anti-corrosão
- Aplicável em temperaturas de -60 a +80 °C
- Projetado para alimentação de 12 V ou 24 V DC
- Disponíveis vários acessórios de fixação.

- Electromagnetic lock for 2 leaves**
- Body made in anodized aluminum
- No residual magnetism
- Holding force of 500kg by leaf
- Low consumption 0,7A for 12 VDC and 0,35A for 24 VDC
- Led light for door control
- Anti-corrosion protected
- Suitable for temperatures between -60 and +80°C
- Designed for connection to 12 V or 24 V DC supplies
- Available several different fixing accessories

- Cerradura electromagnética para 2 hojas**
- Cuerpo en aluminio anodizado
- Sin magnetismo residual
- Fuerza de sujeción de 500kg por hoja
- Bajo consumo de 0,7A para 12 VDC y 0,35A para 24 VDC
- Led indicador de posición de la puerta
- Tratamiento anti-corrosión
- Aplicable en temperaturas desde -60 hasta 80 ° C
- Diseñado para conexión de 12 V o 24 V DC
- Varios accesorios de montaje disponibles.

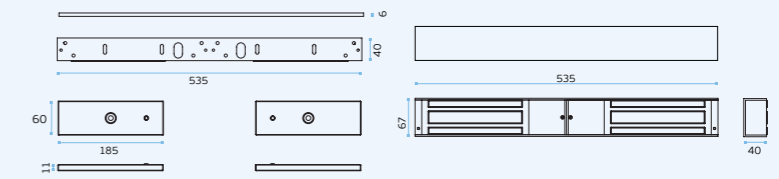

EN 50081-1/1992: EN 55014
EN 500 82-1/1997: EN 55015-2



IN.28.693

- Suporte em Z ajustável para IN.28.690/691 /**
Adjustable Z bracket for IN.28.690 and IN.28.691 /
SopORTE en Z ajustable para IN.28.690 y IN.28.691.

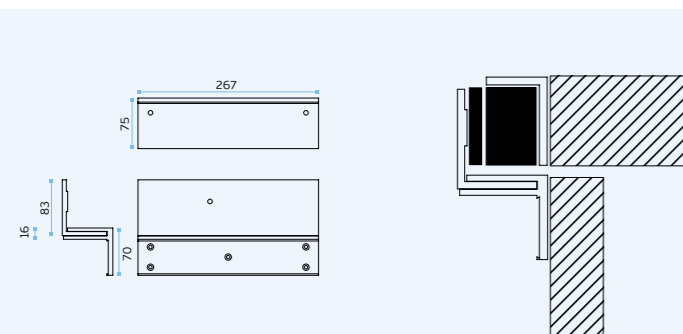

IN.28.694

- Suporte em L para IN.28.690 e IN.28.691 /**
L bracket for IN.28.690 and IN.28.691 /
SopORTE en L para IN.28.690 y IN.28.691

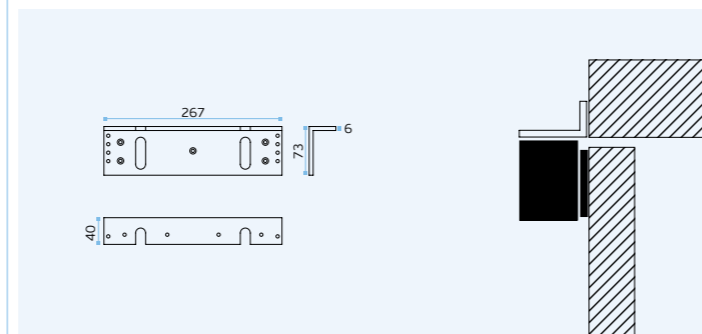

IN.28.695

- Armadura para placa aplicável com IN.28.690 e IN.28.691 /**
Rim armature housing for IN.28.690 and IN.28.691 /
Armadura para placa aplicavel con IN.28.690 y IN.28.691

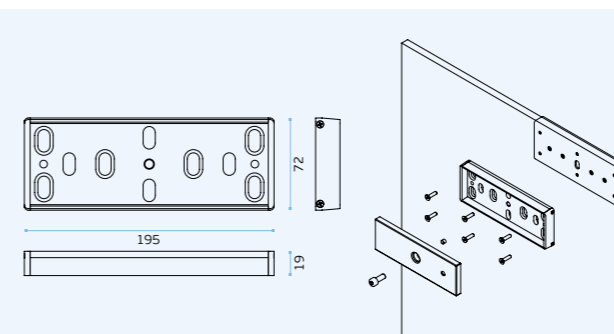

IN.28.696

- Pinça para porta em vidro aplicável com IN.28.695 /**
Glass door clamp for IN.28.695 /
Pinza para puerta en cristal aplicable con IN.28.695

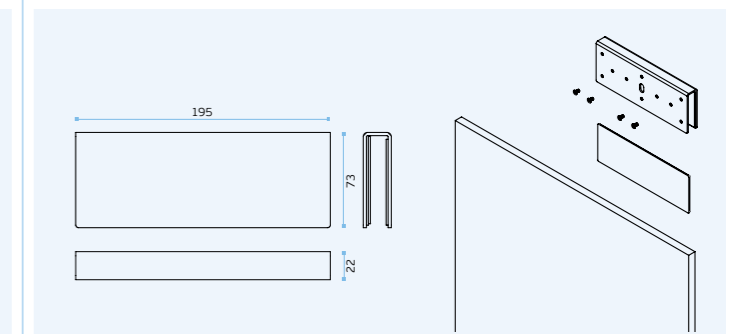

DISPOSITIVOS ELECTROMAGNÉTICOS / ELECTROMAGNETIC DEVICES / DISPOSITIVOS ELECTROMAGNETICOS.

"SHEAR LOCK" combinação de potência de electromagnética com resistência de bloco mecânica. Menos consumo com melhor desempenho. Adequado para portas interiores, de saída ou de entrada que exijam um desbloqueio de emergência. Estes sistemas proporcionam um desbloqueio positivo, e instantâneo, quer seja causado por sinal do centro de comando de incêndio, remoto ou controlo de acesso.

"SHEAR LOCK" combination of electromagnetic power with mechanical block resistance. Less consumption with better performance. Suitable for interior, exit or entry doors that require fail-safe emergency unlocking. These systems provide positive, instantaneous unlocking whether caused by a signal from the fire command centre, remote or access control.

"SHEAR LOCK" combinación de la potencia del electromagnético con la resistencia del bloqueo mecánico. Menor consumo con mejor rendimiento. Adecuada para puertas interiores, de salida o entrada que requieran desbloqueo de emergencia. Estos sistemas proporcionan un desbloqueo positivo e instantáneo ya sea por señal de la central de incendios, control remoto o de accesos.

1x - IN.28.697

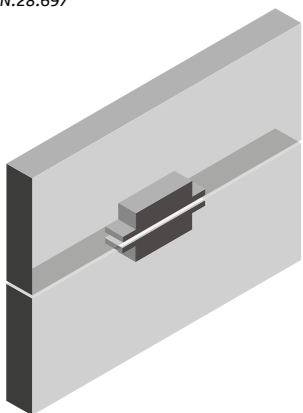

Aplicação para portas de madeira ou metálicas. Solução embutida no aro e porta / Application for wooden or metal doors. Built-in solution in the frame and door / Aplicación para puertas de madera o metal. Solución empotrada en el marco y la puerta /

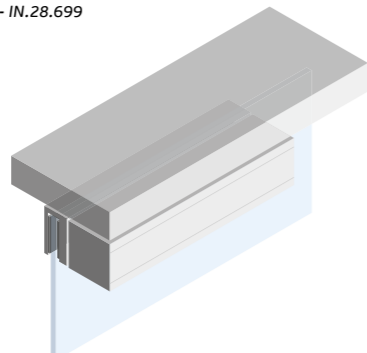
1x - IN.28.697
1x - IN.28.698
1x - IN.28.699

Aplicação para portas de vidro. Caixa sobreposta na porta e recetor embutido no teto ou aro / Application for glass doors. Box overlapped in the door and receiver embedded in the ceiling or frame / Aplicación para puertas de cristal. Caja sobrepuesta en la puerta y receptor empotrado en el techo o el marco.

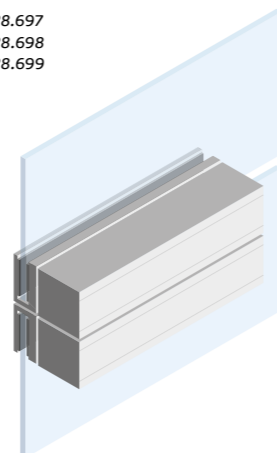
1x - IN.28.697
2x - IN.28.698
2x - IN.28.699

Aplicação para porta e bandeira em vidro. Caixas sobrepostas com pinça de vidro / Application for glass door and flag. Overlapping boxes with glass clamp / Aplicación para puerta y bandera de cristal. Cajas superpuestas con pinza para cristal /

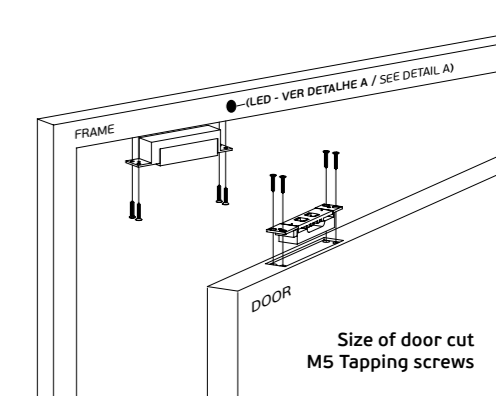

IN.28.697

Fechadura eletromagnética com bloqueio mecânico
- Corpo em alumínio anodizado
- Sem magnetismo residual
- Força de retenção de 1200kg
- Baixo consumo de 1,15A para 12 VDC e 1,55A para 24 VDC
- Para portas estreitas min 35mm
- Tratamento Anti-corrosão
- Aplicável em temperaturas de -60 a +80 °C
- Projetado para alimentação de 12 V DC ou 24 V DC (1,10 A a 2 A)
- Disponíveis vários acessórios de fixação.

Shear lock
- Body made in anodized aluminum
- No residual magnetism
- Holding force of 1200 kg
- Low consumption 1,15A for 12 VDC and 1,55A for 24 VDC
- For low thickness doors min 35mm
- Anti-corrosion protected
- Suitable for temperatures between -60 and +80°C
- Designed for connection to 12 V DC or 24 V DC (1,10 A a 2 A) supplies
- Available several different fixing accessories

Cerradura electromagnética con bloqueo mecánico
- Cuerpo en aluminio anodizado
- Sin magnetismo residual
- Fuerza de sujeción de 1200 kg
- Bajo consumo de 1.15A para 12 VDC y 1,55A para 24 VDC
- Para puertas estrechas min 35mm.
- Tratamiento anti-corrosión
- Aplicable en temperaturas desde -60 hasta 80 °C
- Diseñado para conexión de 12 V DC o 24 V DC (1,10 A a 2 A)
- Varios accesorios de montaje disponibles.

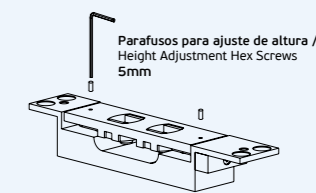
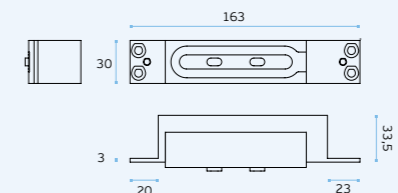
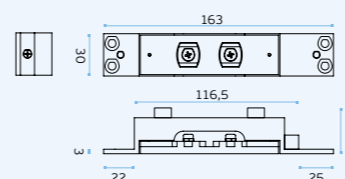
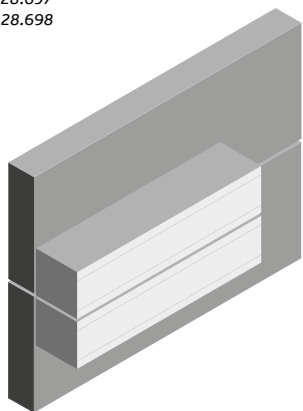
1x - IN.28.697
2x - IN.28.698

Aplicação para portas de madeira ou metálicas. Solução sobreposta no aro e porta / Application for wooden or metal doors. Rim solution in the frame and door / Aplicación para puertas de madera o metal. Solución sobrepuesta en el marco y la puerta /

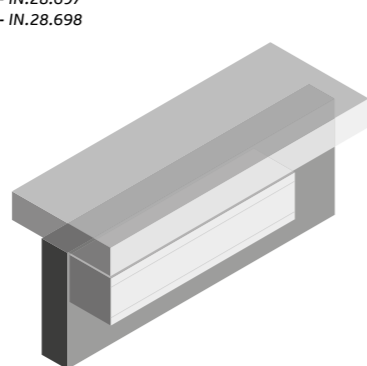
1x - IN.28.697
1x - IN.28.698

Aplicação para portas de madeira ou metálicas. Solução sobreposta na porta e receptor embutido no tecto ou aro / Application for wooden or metal doors. Box overlapped in the door and receiver embedded in the ceiling or frame / Aplicación para puertas de madera o metal. Caja sobrepuesta en la puerta y receptor empotrado en el techo o el marco.

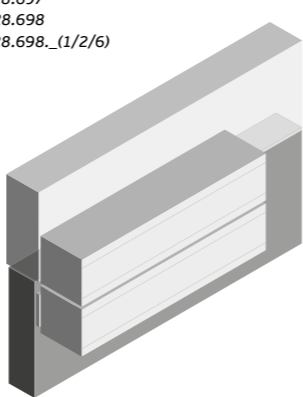
1x - IN.28.697
2x - IN.28.698
1x - IN.28.698_(1/2/6)

Aplicação para portas de madeira ou metálicas. Solução sobreposta no aro e porta com placas de compensação / Application for wooden or metal doors. Rim solution in the frame and door with compensating plates / Aplicación para puertas de madera o metal. Solución sobrepuesta en el marco y la puerta con placas compensadoras.

IN.28.698

Caixa em alumínio para sobrepor aplicável com IN.28.697 / Aluminium surface mounting housing for IN.28.697 / Caja en aluminio de sobreponer aplicable con IN.28.697

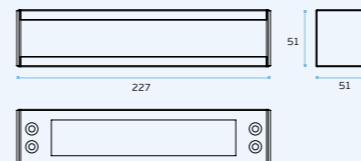

IN.28.699

Pinça para porta em vidro aplicável com IN.28.697 / Glass door clamp for IN.28.697 / Pinza para puerta en cristal aplicable con IN.28.697

Espessura de vidro: 10 - 12,7 mm
Glass thickness / Espesor del cristal

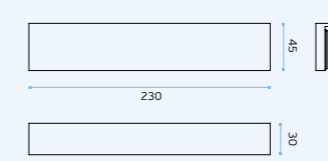

IN.28.698.1

Placa de enchimento de 1mm / 1mm filler plate / Placa de relleno de 1mm.

IN.28.698.2

Placa de enchimento de 2mm / 2mm filler plate / Placa de relleno de 2mm.

IN.28.698.6

Placa de enchimento de 6mm / 6mm filler plate / Placa de relleno de 6mm.

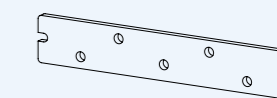

SOLUÇÕES DE FERRAGENS PARA CABINES DE VIDRO / GLASS HARDWARE SOLUTIONS FOR CABINS / SOLUCIONES DE HERRAJES PARA CABINAS DE CRISTAL



soft
closing



SLIM SHOWER SYSTEM

O SISTEMA DE PORTAS DE CORRER JNF PARA DUCHE
GLASS SLIDING DOOR SYSTEM FOR SHOWER
SISTEMA DE MAMPARAS DE BAÑO CORREDERAS

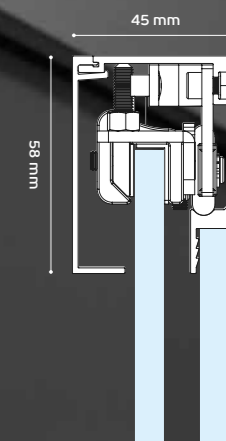

O sistema de portas de correr JNF para duche baseia-se em perfis de alumínio estreitos e conjuntos de roldanas, em aço inoxidável, concebidos para garantir a resistência à água.

As rodas, são produzidas de nylon reforçado com rolamentos de esferas, correm com baixa fricção sobre o perfil de alumínio.

Disponível em 2 cores diferentes, preto mate (RAL 9005) com selantes de vidro preto e cor cinza (RAL 9006) com selantes transparentes de pvc.

O sistema SOFT CLOSING com amortecedores de ar garante o silêncio na entrada ou na saída do chuveiro, além de garantir o fecho perfeito das portas. O conjunto completo de selantes de vidro e o pequeno espaço entre o vidro fixo e a porta evitam o vazamento de água e correntes de ar.

O perfil estreito tem apenas 58mm de altura e 45mm de profundidade, e sua grande modularidade permite diferentes formatos de chuveiros, bem como uma ou duas portas.

O vão livre obtido pela abertura das duas folhas pode ser maior que 900mm, permitindo o uso de cadeira de rodas.

The JNF glass sliding door system for shower is based on slim aluminium profiles and roller assemblies, made of stainless steel, designed to ensure water resistance.

The wheels, which are made of reinforced nylon with ball bearings, run with low friction on the aluminum profile.

Available in 2 different colors, black matte (RAL 9005) with black glass sealants and gray color (RAL 9006) with ultra clear PVC sealants.

The SOFT CLOSING system with air dampers ensures silence when entering or leaving the shower, as well as ensures perfect closing of the doors. The complete set of glass sealants and small gap between fixed glass and door prevents water leakage and air flow.

The slim profile is only 58mm high and 45mm deep, and is great modularity allows different shapes of showers as well as one or two doors.

The wide opening obtained by opening the two leaves can be greater than 900mm, allowing the use of a wheelchair.

Lo sistema de mamparas de baño correderas JNF se basa en perfiles estrechos de aluminio y conjuntos de poleas de acero inoxidable diseñadas para garantizar la estanqueidad.

Las ruedas, fabricadas en nylon reforzado con rodamientos de bolas, se desplazan con baja fricción sobre el perfil de aluminio.

Disponible en 2 colores diferentes, negro mate RAL 9005 con selladores de cristal negro y color gris RAL 9006 con selladores de pvc transparente.

Lo sistema SOFT CLOSING de aire garantiza el silencio al entrar o salir de la ducha, además de garantizar el perfecto cierre de las puertas. El juego completo de selladores de cristal y el pequeño espacio entre el cristal fijo y la puerta evitan fugas de agua y corrientes de aire.

El perfil estrecho tiene solo 58 mm de alto y 45 mm de profundidad, y su gran modularidad permite diferentes formatos de ducha, así como una o dos puertas.

El gran hueco de apertura con dos puertas puede ser superior a 900 mm, lo que permite el uso de sillas de ruedas.

SÉRIE SLIM SHOWER /
SLIM SHOWER SERIES /
SERIE SLIM SHOWER

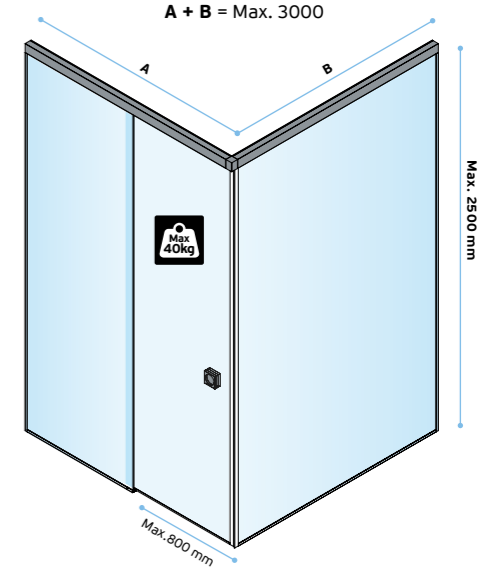
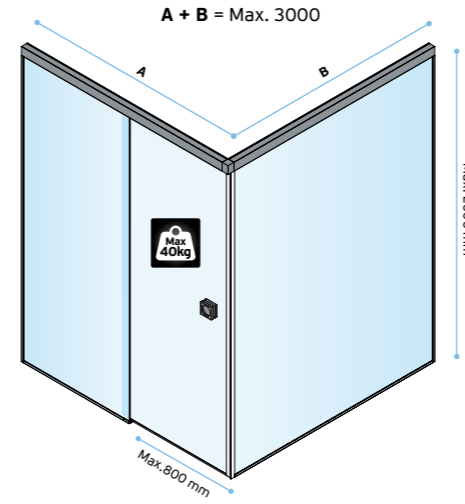
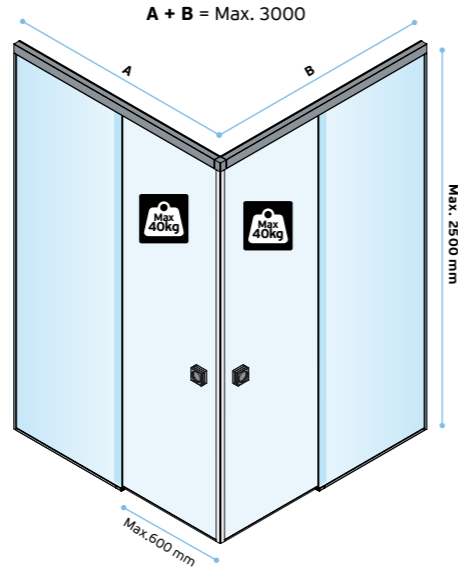
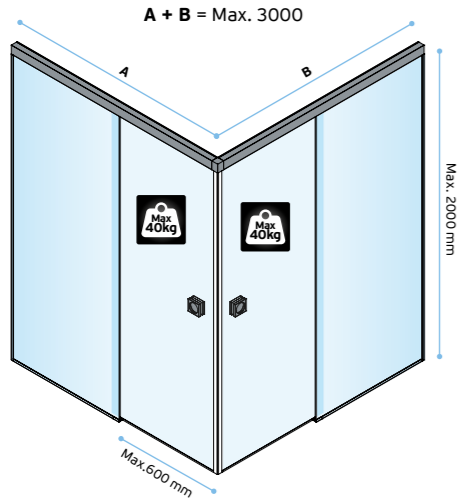

IN.15.360 (RAL 9006 SILVER)
Cabine de chuveiro a 90° com 2 portas de correr com soft close /
90° shower cabin with 2 sliding door with soft close /
Cabina de ducha 90° con 2 puertas correderas con soft close.



IN.15.360.L (RAL 9006 SILVER)
Cabine de chuveiro a 90° com 2 portas de correr com soft close /
90° shower cabin with 2 sliding door with soft close /
Cabina de ducha 90° con 2 puertas correderas con soft close.



IN.15.361 (RAL 9006 SILVER)
Cabine de chuveiro a 90° com 1 porta de correr com soft close /
90° shower cabin with 1 sliding door with soft close /
Cabina de ducha 90° con 1 puerta corredera con soft close.



IN.15.361.L (RAL 9006 SILVER)
Cabine de chuveiro a 90° com 1 porta de correr com soft close /
90° shower cabin with 1 sliding door with soft close /
Cabina de ducha 90° con 1 puerta corredera con soft close.



IN.15.360.SS (RAL 9006 SILVER)
Cabine de chuveiro a 90° com 2 portas de correr /
90° shower cabin with 2 sliding door /
Cabina de ducha 90° con 2 puertas correderas.



IN.15.360.L.SS (RAL 9006 SILVER)
Cabine de chuveiro a 90° com 2 portas de correr /
90° shower cabin with 2 sliding door /
Cabina de ducha 90° con 2 puertas correderas.



IN.15.361.SS (RAL 9006 SILVER)
Cabine de chuveiro a 90° com 1 porta de correr /
90° shower cabin with 1 sliding door /
Cabina de ducha 90° con 1 puerta corredera.



IN.15.361.L.SS (RAL 9006 SILVER)
Cabine de chuveiro a 90° com 1 porta de correr /
90° shower cabin with 1 sliding door /
Cabina de ducha 90° con 1 puerta corredera.



IN.15.360.B (RAL 9005 BLACK)
Cabine de chuveiro a 90° com 2 portas de correr com soft close /
90° shower cabin with 2 sliding door with soft close /
Cabina de ducha 90° con 2 puertas correderas con soft close.



IN.15.360.L.B (RAL 9005 BLACK)
Cabine de chuveiro a 90° com 2 portas de correr com soft close /
90° shower cabin with 2 sliding door with soft close /
Cabina de ducha 90° con 2 puertas correderas con soft close.



IN.15.361.B (RAL 9005 BLACK)
Cabine de chuveiro a 90° com 1 porta de correr com soft close /
90° shower cabin with 1 sliding door with soft close /
Cabina de ducha 90° con 1 puerta corredera con soft close.



IN.15.361.L.B (RAL 9005 BLACK)
Cabine de chuveiro a 90° com 1 porta de correr com soft close /
90° shower cabin with 1 sliding door with soft close /
Cabina de ducha 90° con 1 puerta corredera con soft close.



IN.15.360.B.SS (RAL 9005 BLACK)
Cabine de chuveiro a 90° com 2 portas de correr /
90° shower cabin with 2 sliding door /
Cabina de ducha 90° con 2 puertas correderas.



IN.15.360.L.B.SS (RAL 9005 BLACK)
Cabine de chuveiro a 90° com 2 portas de correr /
90° shower cabin with 2 sliding door /
Cabina de ducha 90° con 2 puertas correderas.



IN.15.361.B.SS (RAL 9005 BLACK)
Cabine de chuveiro a 90° com 1 porta de correr /
90° shower cabin with 1 sliding door /
Cabina de ducha 90° con 1 puerta corredera.



IN.15.361.L.B.SS (RAL 9005 BLACK)
Cabine de chuveiro a 90° com 1 porta de correr /
90° shower cabin with 1 sliding door /
Cabina de ducha 90° con 1 puerta corredera.



SOLUÇÕES DE FERRAGENS PARA CABINES DE VIDRO / GLASS HARDWARE SOLUTIONS FOR CABINS / SOLUCIONES DE HERRAJES PARA CABINAS DE CRISTAL

SLIM SHOWER SYSTEM

SISTEMA MODULAR ADAPTAVEL A QUALQUER CONFIGURAÇÃO DE CHUVEIRO. KIT COMPLETO COM EXCEÇÃO DO VIDRO. O CONFIGURADOR FACILITA A CONFIGURAÇÃO DA CABINE E TODAS AS MEDIDAS NECESSÁRIAS PARA A PRODUÇÃO DOS VIDROS /

MODULAR SYSTEM ADAPTABLE TO ANY SHOWER CONFIGURATION. COMPLETE SET EXCEPT THE GLASS. THE CONFIGURATOR MAKES IT EASY TO CREATE THE CABIN AND ALL THE NECESSARY MEASURES FOR THE GLASS PRODUCTION / SISTEMA MODULAR ADAPTAVEL A CUALQUIER CONFIGURACIÓN DE CABINA. KIT COMPLETO EXCEPTO EL VIDRIOS. EL CONFIGURADOR FACILITA LA CONFIGURACION DE LA CABINA Y TODAS LAS MEDIDAS NECESARIAS PARA LA PRODUCCIÓN DE CRISTAL.

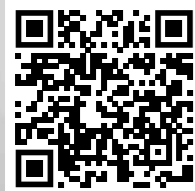

soft
closing



KIT



NO
glass
cut



DDA



IMAGE / IMAGEM:
IN.15.364.B

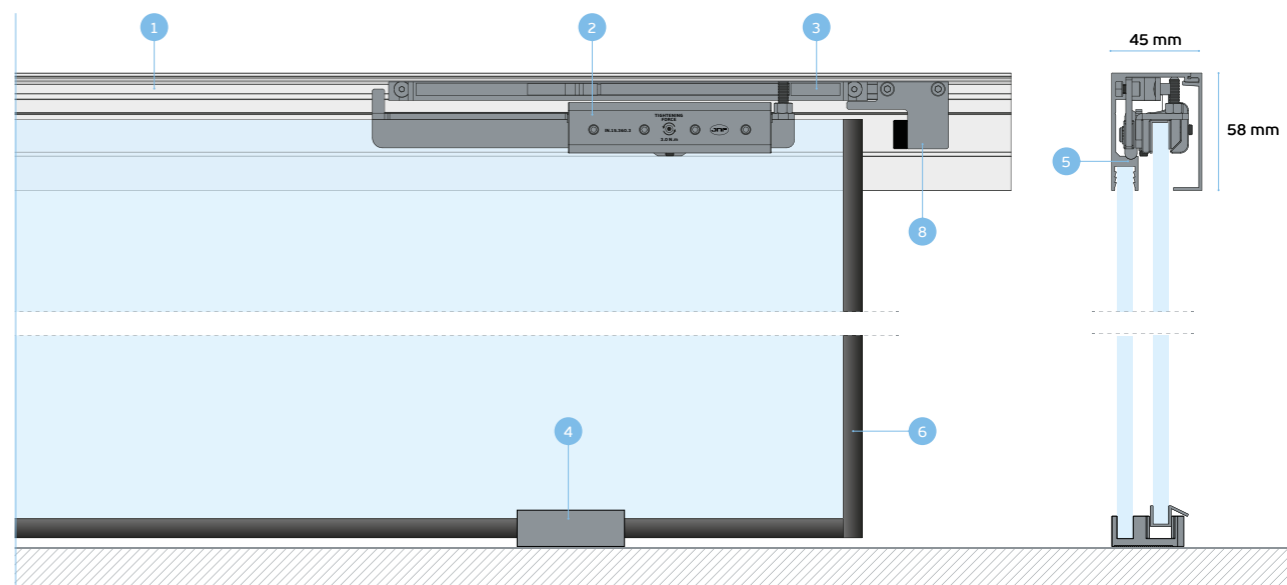

1. Perfil superior e suporte de vidro fixo em alumínio anodizado com 58x45x2000mm.
2. Roldanas em aço inoxidável com capacidade para 60kg, para vidro de 8mm. Ajustável em altura ± 4 mm. Rodízios em nylon, reforçado com fibra de vidro, com rolamentos de esferas.
3. Soft close pneumático na abertura e fecho da porta.
4. Guia de pavimento e suporte do vidro fixo em nylon. Pode ser colada ou aparafusada.
5. Perfil para vidros fixos em alumínio com vedante de silicone. Pode ser colada ou aparafusada.
6. Vedantes em PVC e silicone incluídos, garantem perfeito isolamento da água.
7. Puxador duplo IN.16.526 em aço inoxidável incluído.
8. Batentes e suportes à parede em aço inoxidável.

1. Top anodized aluminium profile and fixed glass support with 58x45x2000mm.
2. Stainless steel roller assembly with a capacity of 60kg, for 8mm glass. Adjustable in height ± 4 mm. Reinforced nylon wheels with ball bearings.
3. Pneumatic soft close when opening and closing the door.
4. Floor guide and fixed glass support in nylon. Can be glued or screwed.
5. Profile for fixed aluminium windows with silicone sealant. Can be glued or screwed.
6. Included PVC and silicone sealants to ensure perfect water insulation.
7. Double knob IN.16.526 in stainless steel.
8. Stoppers and wall supports made in stainless steel.

1. Perfil superior y soporte fijo de cristal en aluminio anodizado de 58x45x2000mm.
2. Poleas de acero inoxidable con capacidad de 60kg, para cristal de 8mm. Regulable en altura ± 4 mm. Ruedas de nylon, reforzadas con fibra de cristal, con rodamientos de bolas.
3. Cierre suave neumático al abrir y cerrar la puerta.
4. Guía de piso y soporte fijo de cristal en nylon. Se puede pegar o atornillar.
5. Perfil para ventanas fijas de aluminio con sellador de silicona. Se puede pegar o atornillar.
6. Juntas de PVC y silicona incluidas, garantizan un perfecto aislamiento del agua.
7. Pomo doble IN.16.526 de acero inoxidable incluído.
8. Topes y soportes de pared de acero inoxidable.

SÉRIE SLIM SHOWER /
SLIM SHOWER SERIES /
SERIE SLIM SHOWER

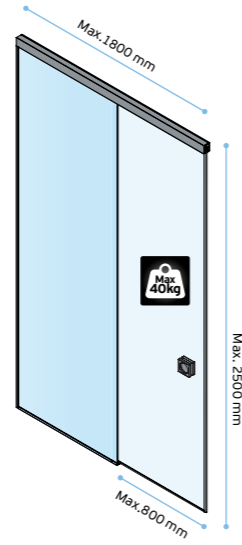
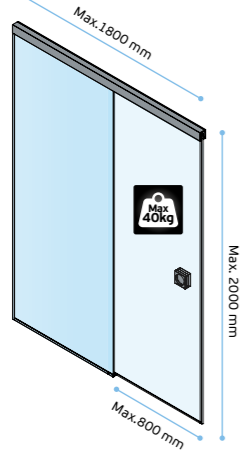

IN.15.364 (RAL 9006 SILVER)
Cabine de chuveiro com 1 porta de correr com soft close /
Shower cabin with 1 sliding door with soft close /
Cabina de ducha con 1 puerta corredera con soft close.



IN.15.364.L (RAL 9006 SILVER - LARGE)
Cabine de chuveiro com 1 porta de correr com soft close /
Shower cabin with 1 sliding door with soft close /
Cabina de ducha con 1 puerta corredera con soft close.



IN.15.364.B (RAL 9005 BLACK)
Cabine de chuveiro com 1 porta de correr com soft close /
Shower cabin with 1 sliding door with soft close /
Cabina de ducha con 1 puerta corredera con soft close.



IN.15.364.L.B (RAL 9005 BLACK - LARGE)
Cabine de chuveiro com 1 porta de correr com soft close /
Shower cabin with 1 sliding door with soft close /
Cabina de ducha con 1 puerta corredera con soft close.



IN.15.364.SS.B (RAL 9005 BLACK)
Cabine de chuveiro com 1 porta de correr /
Shower cabin with 1 sliding door /
Cabina de ducha con 1 puerta corredera.



IN.15.364.L.SS.B (RAL 9005 BLACK - LARGE)
Cabine de chuveiro com 1 porta de correr /
Shower cabin with 1 sliding door /
Cabina de ducha con 1 puerta corredera.

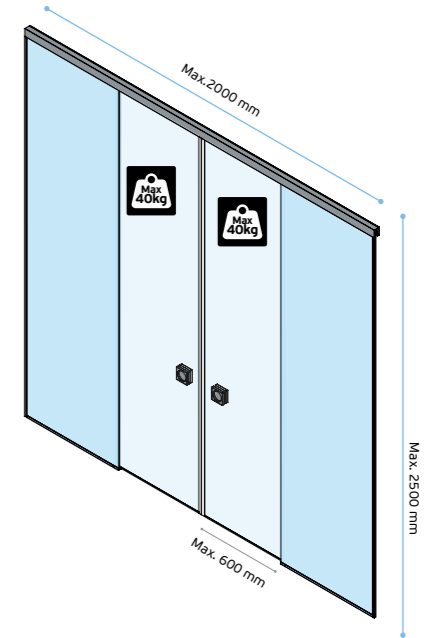
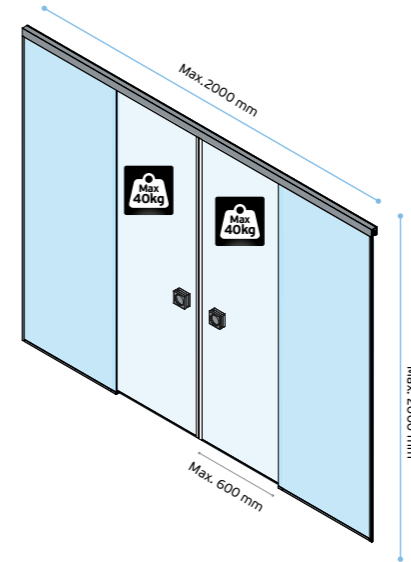

IN.15.365 (RAL 9006 SILVER)
Cabine de chuveiro com 2 portas de correr com soft close /
Shower cabin with 2 sliding doors with soft close /
Cabina de ducha con 2 puertas corredera con soft close.



IN.15.365.L (RAL 9006 SILVER - LARGE)
Cabine de chuveiro com 2 portas de correr com soft close /
Shower cabin with 2 sliding doors with soft close /
Cabina de ducha con 2 puertas corredera con soft close.



IN.15.365.B (RAL 9005 BLACK)
Cabine de chuveiro com 2 portas de correr com soft close /
Shower cabin with 2 sliding doors with soft close /
Cabina de ducha con 2 puertas corredera con soft close.



IN.15.365.L.B (RAL 9005 BLACK - LARGE)
Cabine de chuveiro com 2 portas de correr com soft close /
Shower cabin with 2 sliding doors with soft close /
Cabina de ducha con 2 puertas corredera con soft close.



IN.15.365.SS.B (RAL 9005 BLACK)
Cabine de chuveiro com 2 portas de correr /
Shower cabin with 2 sliding doors /
Cabina de ducha con 2 puertas corredera.



IN.15.365.L.SS.B (RAL 9005 BLACK - LARGE)
Cabine de chuveiro com 2 portas de correr /
Shower cabin with 2 sliding doors /
Cabina de ducha con 2 puertas corredera.



SOLUÇÕES DE FERRAGENS PARA CABINES DE VIDRO / GLASS HARDWARE SOLUTIONS FOR CABINS / SOLUCIONES DE HERRAJES PARA CABINAS DE CRISTAL

CLEAR SHOWER SYSTEM

SISTEMA DESENHADO PARA TER O MÍNIMO DE FOLGA ENTRE VIDRO FIXO E PORTA, MINIMIZANDO SAÍDA DE ÁGUA / SYSTEM DESIGNED TO HAVE THE MINIMUM GAP BETWEEN FIXED GLASS AND DOOR, MINIMIZING WATER LEAKAGE / SISTEMA DISEÑADO PARA TENER EL MÍNIMO ESPACIO ENTRE EL CRISTALFIJO Y LA PUERTA, MINIMIZANDO LA SALIDA DE AGUA.

A TRANSPARÊNCIA DO VIDRO COMBINADA COM AS RODAS METÁLICAS REDONDAS, CRIA O SISTEMA "CLEAR" EM TUBO DE AÇO INOX Ø25MM / THE CLEANLINESS OF THE GLASS COMBINED WITH THE METALLIC ROUND WHEELS, CREATES THE CLEAR SYSTEM IN STAINLESS STEEL TUBE Ø25MM / LA TRANSPARENCIA DEL CRISTALCOMBINADA CON LAS RUEDAS METÁLICAS REDONDAS CREA EL SISTEMA "CLEAR" EN TUBO DE ACERO INOXIDABLE Ø25MM /

12
mm

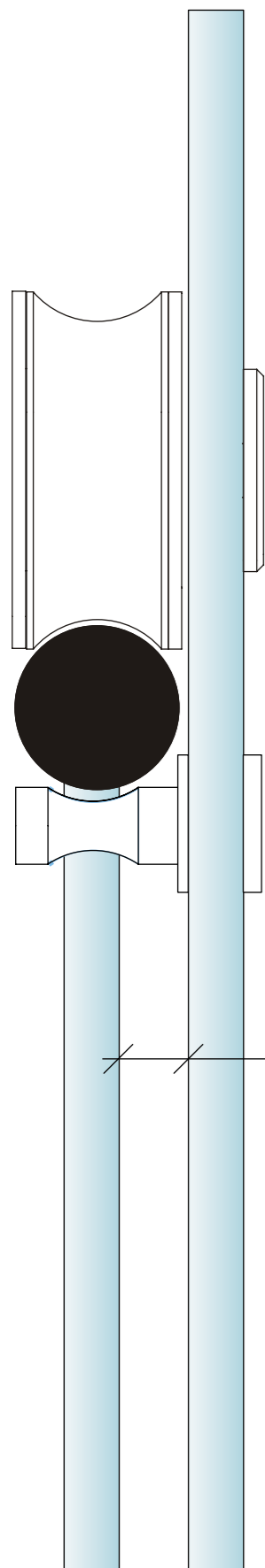

SOLUÇÕES DE FERRAGENS PARA CABINES DE VIDRO / GLASS HARDWARE SOLUTIONS FOR CABINS / SOLUCIONES DE HERRAJES PARA CABINAS DE CRISTAL



CLEAR PIN System for glass

IN.15.355 (MÁX.1000mm)

- 2x - **Tubo 1000mm (Ø25mm)** /
Tube 1000mm (Ø25mm) / Tubo 1000mm (Ø25mm) - **IN.15.032**
- 2x - **Suporte de tubo e parede** /
Wall and tube support / Soporte de tubo e pared - **IN.15.028**
- 1x - **Conector 90°** /
Connector 90° / Conector 90° - **IN.15.114**
- 2x - **Suporte de tubo e vidro fixo** /
Tube and fixed glass support / Soporte de tubo e cristal fijo - **IN.15.036**

* Vidro e roldanas não incluídas / Glass and wheels not included / Cristal y ruedas no incluido *

RODAS COMPATÍVEIS SUITABLE WHEELS / RUEDAS COMPATIBLES

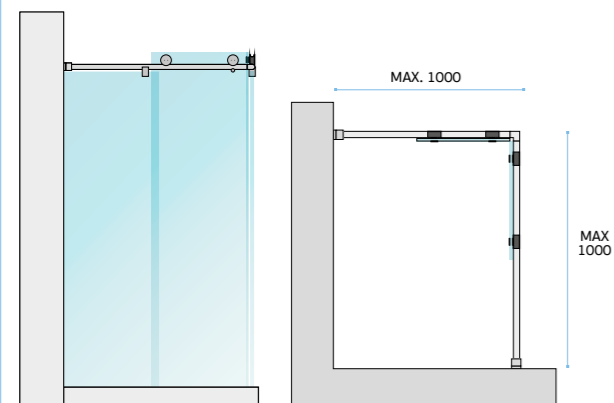
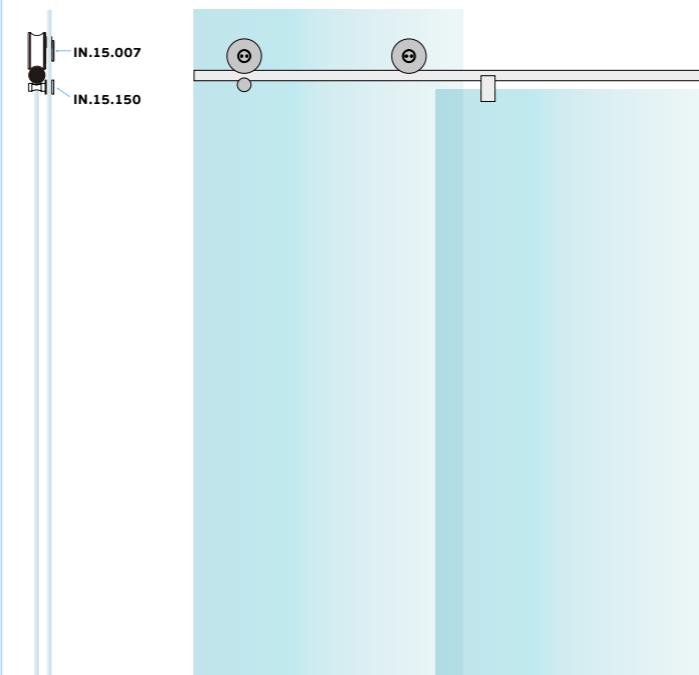

CLEAR PIN 90° WALL TO WALL

**SISTEMA DE CABINE DE CHUVEIRO 90°
COM PORTA DUPLA. DESENVOLVIDO PARA
QUE A FOLGA ENTRE FIXO E PORTA SEJA
REDUZIDA AO MÍNIMO /**

**90° SHOWER CUBICLE SYSTEM WITH DOUBLE
DOOR. DEVELOPED SO THAT THE GAP BETWEEN
FIXED AND DOOR IS REDUCED TO THE MINIMUM /
SISTEMA DE CABINA DE DUCHA 90° CON DOBLE
PUERTA. DESARROLLADO PARA QUE EL ESPACIO
ENTRE FIJO Y PUERTA SE REDUZCA AL MÍNIMO /**

SOLUÇÕES DE FERRAGENS PARA CABINES DE VIDRO / GLASS HARDWARE SOLUTIONS FOR CABINS / SOLUCIONES DE HERRAJES PARA CABINAS DE CRISTAL



IMAGE / IMAGEM:
IN.15.354.1.TG
IN.15.007.TG
IN.15.150.TG

CLEAR PIN System for glass

IN.15.354.1 (MAX 1000MM)

- 1x - **Tubo 1000mm (Ø25mm)** /
Tube 1000mm (Ø25mm) / Tubo 1000mm (Ø25mm) - **IN.15.032**
- 1x - **Suporte de tubo e parede** / Wall and tube support /
Soporte de tubo y pared - **IN.15.028**
- 1x - **Suporte tubo e vidro lateral** / Tube and lateral glass support /
Tubo y soporte de cristal lateral - **IN.15.029**
- 1x - **Suporte de tubo e vidro fixo** /
Tube and fixed glass support / Soporte de tubo e cristal fijo - **IN.15.036**

* Vidro e roldanas não incluídas / Glass and wheels not included / Cristal y ruedas no incluido *

IN.15.354.2 (MAX 2000MM)

- 1x - **Tubo 2000mm (Ø25mm)** /
Tube 2000mm (Ø25mm) / Tubo 2000mm (Ø25mm) - **IN.15.031**
- 1x - **Suporte de tubo e parede** / Wall and tube support /
Soporte de tubo y pared - **IN.15.028**
- 1x - **Suporte tubo e vidro lateral** / Tube and lateral glass support /
Tubo y soporte de cristal lateral - **IN.15.029**
- 1x - **Suporte de tubo e vidro fixo** /
Tube and fixed glass support / Soporte de tubo e cristal fijo - **IN.15.036**

* Vidro e roldanas não incluídas / Glass and wheels not included / Cristal y ruedas no incluido *

RODAS COMPATÍVEIS SUITABLE WHEELS / RUEDAS COMPATIBLES

Rodas compatíveis / Suitable wheels / Ruedas compatibles
1x - **IN.15.007** + 1x **IN.15.150**

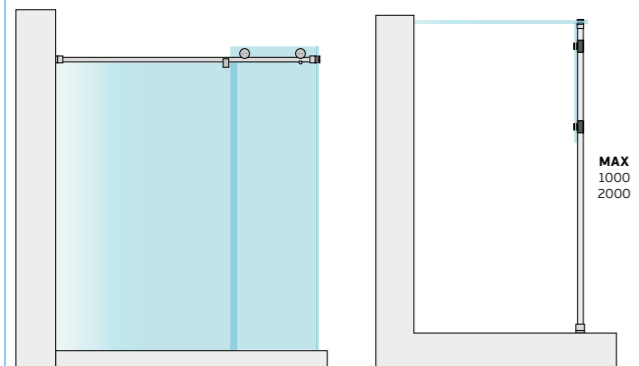
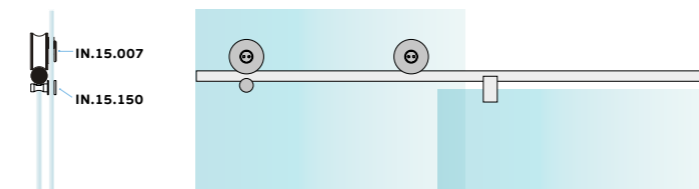

CLEAR PIN 90° WALL TO GLASS

SISTEMA DE CABINE DE
CHUVEIRO 90° COM PORTA
SIMPLES E VIDRO FIXO LATERAL.
DESENVOLVIDO PARA QUE A
FOLGA ENTRE FIXO E PORTA SEJA
REDUZIDA AO MÍNIMO /
90° SHOWER CUBICLE SYSTEM
WITH SINGLE DOOR AND SIDE FIXED
GLASS. DEVELOPED SO THAT THE
GAP BETWEEN FIXED AND DOOR
IS REDUCED TO THE MINIMUM /
SISTEMA DE CABINA DE DUCHA 90°
CON PUERTA SIMPLE Y CRISTAL FIJO
LATERAL. DESARROLLADO PARA
QUE EL ESPACIO ENTRE FIJO Y
PUERTA SE REDUZCA AL MÍNIMO /



IMAGE / IMAGEM:
IN.15.354.1
IN.15.007
IN.15.150
IN.16.567.A

SOLUÇÕES DE FERRAGENS PARA CABINES DE VIDRO / GLASS HARDWARE SOLUTIONS FOR CABINS / SOLUCIONES DE HERRAJES PARA CABINAS DE CRISTAL



CLEAR PIN System for glass

IN.15.356 (MÁX.1000mm)

- 1x - **Tubo 1000mm (Ø25mm)** /
Tube 1000mm (Ø25mm) / Tubo 1000mm (Ø25mm) - **IN.15.032**
- 2x - **Suporte de tubo e parede** /
Wall and tube support / Soporte de tubo e pared - **IN.15.028**
- 1x - **Suporte de tubo e vidro fixo** /
Tube and fixed glass support / Soporte de tubo e cristal fijo - **IN.15.036**

* Vidro e roldanas não incluídas / Glass and wheels not included / Cristal y ruedas no incluido *

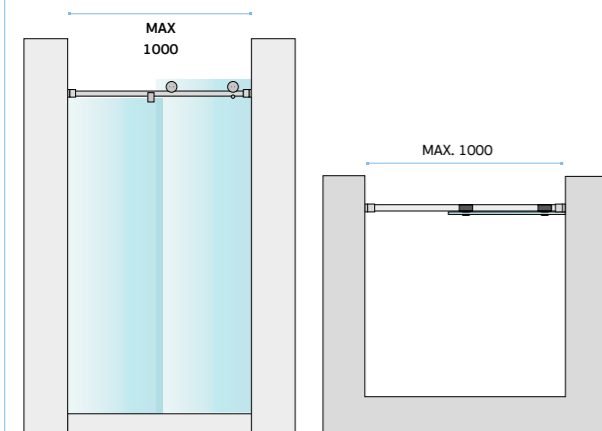

RODAS COMPATÍVEIS SUITABLE WHEELS / RUEDAS COMPATIBLES

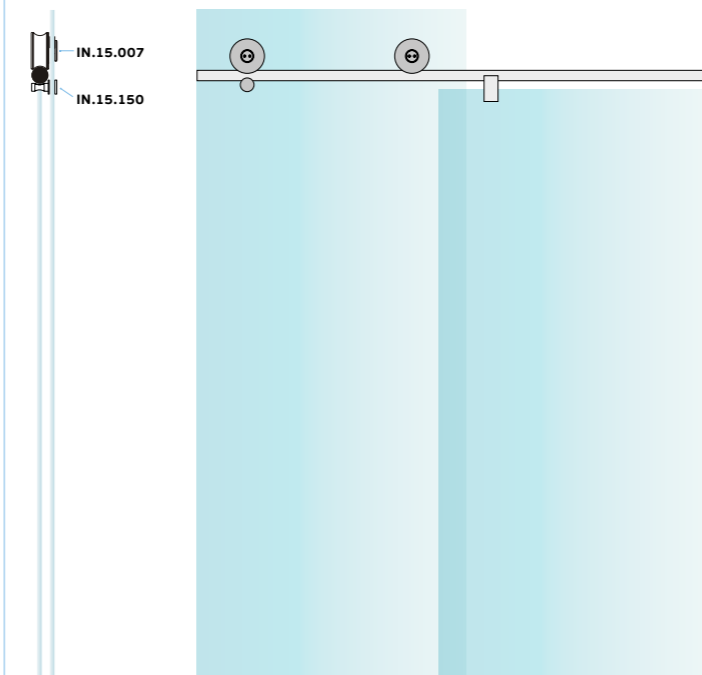

CLEAR PIN 180° WALL TO WALL

**SISTEMA DE CABINE DE
CHUVEIRO 180° COM PORTA
SIMPLES. DESENVOLVIDO PARA
QUE A FOLGA ENTRE FIXO E
PORTA SEJA REDUZIDA
AO MÍNIMO /
180° SHOWER CUBICLE SYSTEM
WITH SINGLE DOOR. DEVELOPED
SO THAT THE GAP BETWEEN
FIXED AND DOOR IS REDUCED TO THE
MINIMUM / SISTEMA DE CABINA DE
DUCHA 180° CON PUERTA SIMPLE.
DESARROLLADO PARA QUE EL
ESPACIO ENTRE FIJO Y PUERTA SE
REDUZCA AL MÍNIMO.**

SOLUÇÕES DE FERRAGENS PARA CABINES DE VIDRO / GLASS HARDWARE SOLUTIONS FOR CABINS / SOLUCIONES DE HERRAJES PARA CABINAS DE CRISTAL



IMAGE / IMAGEM:
IN.15.357
IN.15.007
IN.15.150

CLEAR PIN System for glass

IN.15.357 (MAX 2000MM)

- 1x - **Tubo 2000mm (Ø25mm)** /
Tube 2000mm (Ø25mm) / Tubo 2000mm (Ø25mm) - **IN.15.031**
- 2x - **Suporte de tubo e parede** / Wall and tube support /
Soporte de tubo y pared - **IN.15.028**
- 2x - **Suporte de tubo e vidro fixo** /
Tube and fixed glass support / Soporte de tubo e cristal fijo - **IN.15.036**

* Vidro e roldanas não incluídas / Glass and wheels not included / Cristal y ruedas no incluido *

RODAS COMPATÍVEIS SUITABLE WHEELS / RUEDAS COMPATIBLES

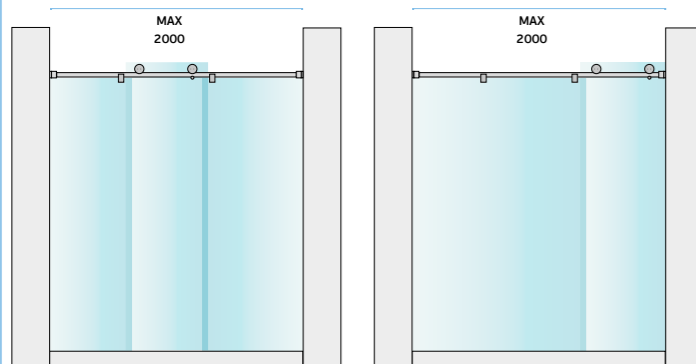
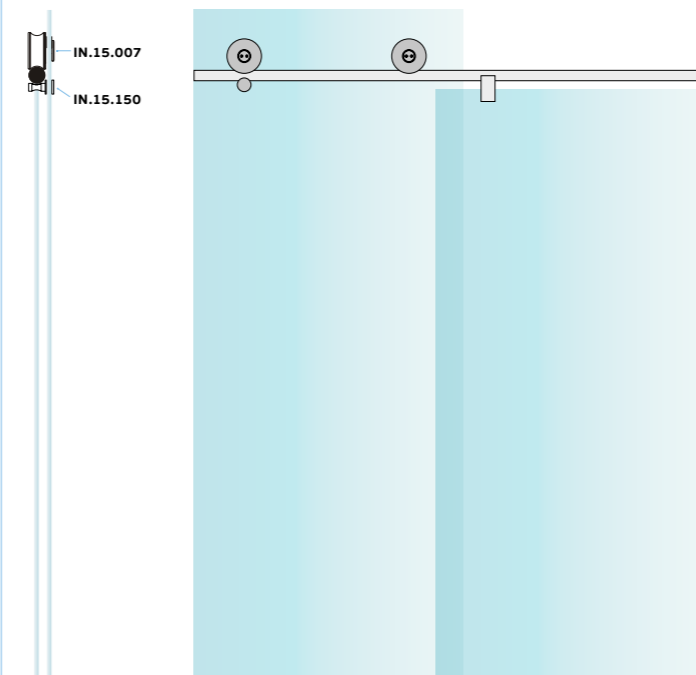

CLEAR PIN 180° WALL TO WALL

**SISTEMA DE CABINE DE CHUVEIRO 180°
COM PORTA SIMPLES. LARGURA MAX. 2MT
DESENVOLVIDO PARA QUE A FOLGA ENTRE
FIXO E PORTA SEJA REDUZIDA AO MÍNIMO /
180° SHOWER CUBICLE SYSTEM WITH SINGLE
DOOR. MAX WIDE 2MT. DEVELOPED SO THAT
THE GAP BETWEEN FIXED AND DOOR IS
REDUCED TO THE MINIMUM / SISTEMA DE
CABINA DE DUCHA 180° CON PUERTA SIMPLE.
ANCHO MAX. 2MT. DESARROLLADO PARA QUE
EL ESPACIO ENTRE FIJO Y PUERTA SE REDUZCA
AL MÍNIMO.**

SOLUÇÕES DE FERRAGENS PARA CABINES DE VIDRO / GLASS HARDWARE SOLUTIONS FOR CABINS / SOLUCIONES DE HERRAJES PARA CABINAS DE CRISTAL

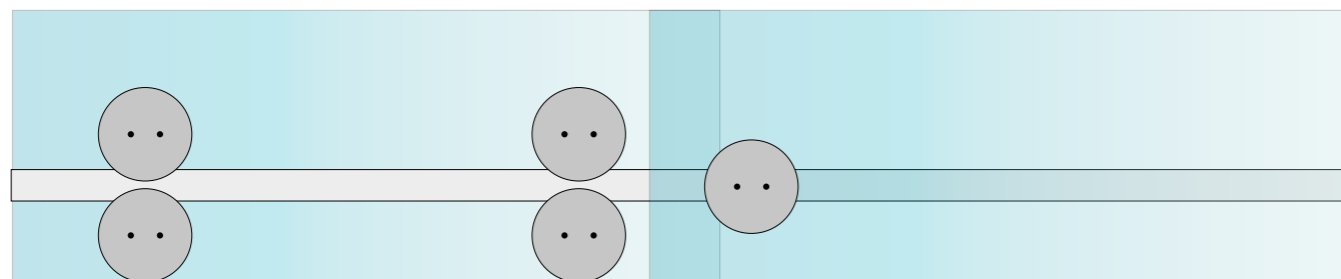
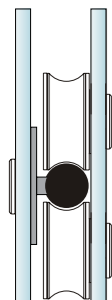

CLEAR SHOWER SYSTEM

**SISTEMA DESENHADO PARA QUE O
ALINHAMENTO ENTRE VIDRO FIXO E
PORTA SEJA O MESMO /**
SYSTEM DESIGNED SO THAT THE
ALIGNMENT BETWEEN FIXED GLASS
AND DOOR IS THE SAME
**SISTEMA DISEÑADO PARA QUE LA
ALINEACIÓN ENTRE CRISTAL FIJO
Y PUERTA SEA LA MISMA.**

**A TRANSPARÊNCIA DO VIDRO COMBINADA
COM AS RODAS METÁLICAS REDONDAS,
CRIA O SISTEMA "CLEAR" EM TUBO DE
AÇO INOX Ø25MM /**
THE CLEANLINESS OF THE GLASS
COMBINED WITH THE METALLIC ROUND
WHEELS, CREATES THE CLEAR SYSTEM IN
STAINLESS STEEL TUBE Ø25MM /
**LA TRANSPARENCIA DEL CRISTAL
COMBINADA CON LAS RUEDAS METÁLICAS
REDONDAS CREA EL SISTEMA "CLEAR" EN
TUBO DE ACERO INOXIDABLE Ø25MM.**

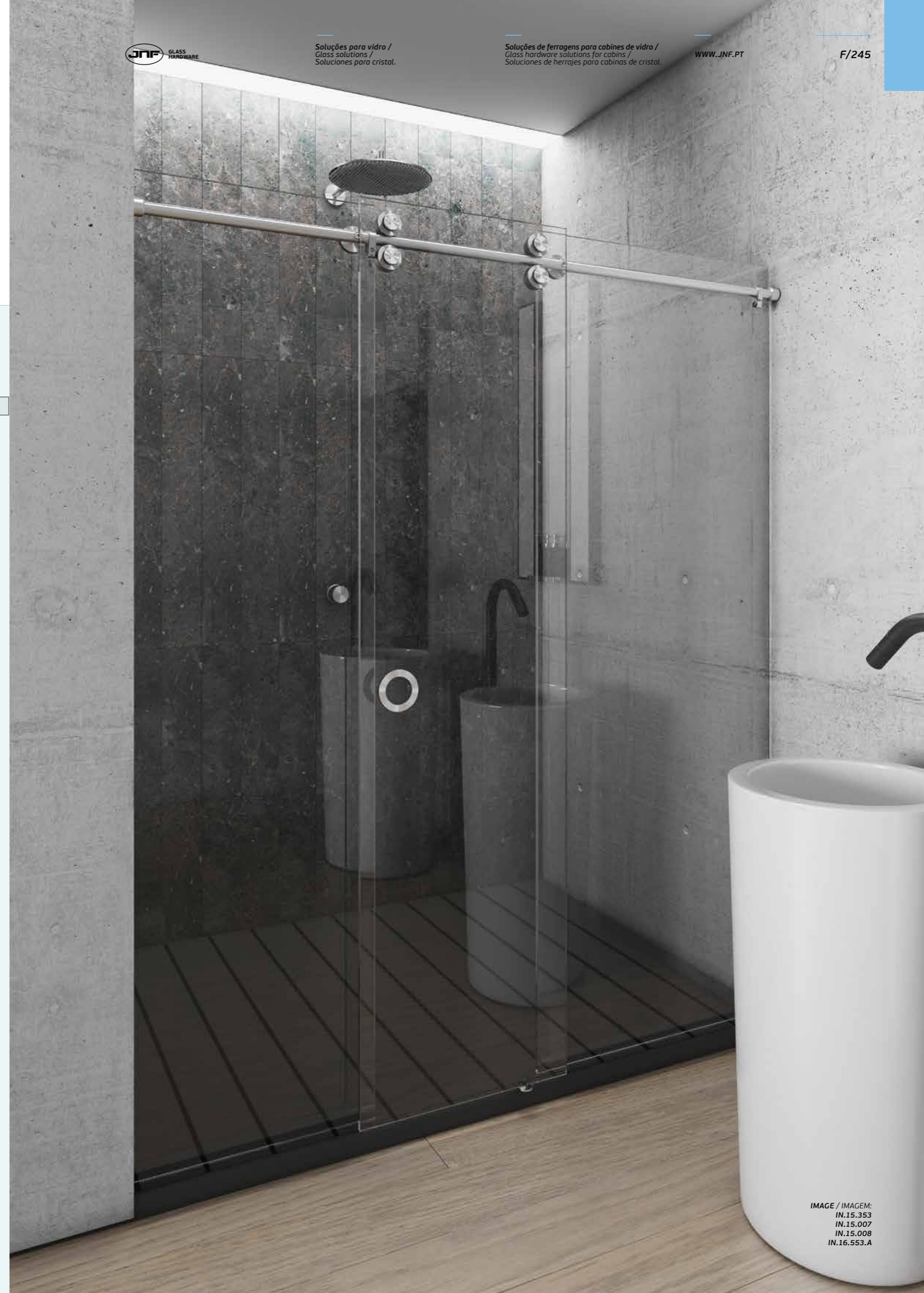

SOLUÇÕES DE FERRAGENS PARA CABINES DE VIDRO / GLASS HARDWARE SOLUTIONS FOR CABINS / SOLUCIONES DE HERRAJES PARA CABINAS DE CRISTAL



 IMAGEM / IMAGE :
 1x - IN.15.350
 2x - IN.15.007
 2x - IN.15.008

CLEAR TWIN System for glass

IN.15.350 (MÁX.1000mm)

- 2x - **Tubo 1000mm (Ø25mm)** /
Tube 1000mm (Ø25mm) / Tubo 1000mm (Ø25mm) - **IN.15.032**
- 2x - **Suporte de tubo e parede** /
Wall and tube support / Soporte de tubo e pared - **IN.15.028**
- 1x - **Conector 90°** /
Connector 90° / Conector 90° - **IN.15.114**
- 2x - **Suporte de tubo e vidro fixo** /
Tube and fixed glass support / Soporte de tubo e cristal fijo - **IN.15.017**
- 2x - **Conector e suporte** /
Connector and support / Conector y soporte - **IN.15.011**

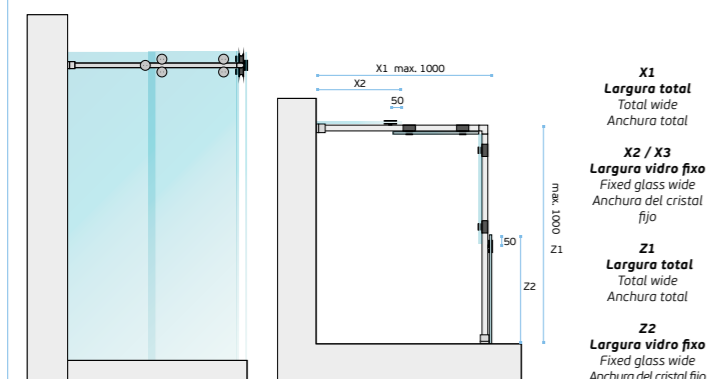
* Vidro e roldanas não incluídas / Glass and wheels not included / Cristal y ruedas no incluido *



RODAS COMPATÍVEIS SUITABLE WHEELS / RUEDAS COMPATIBLES

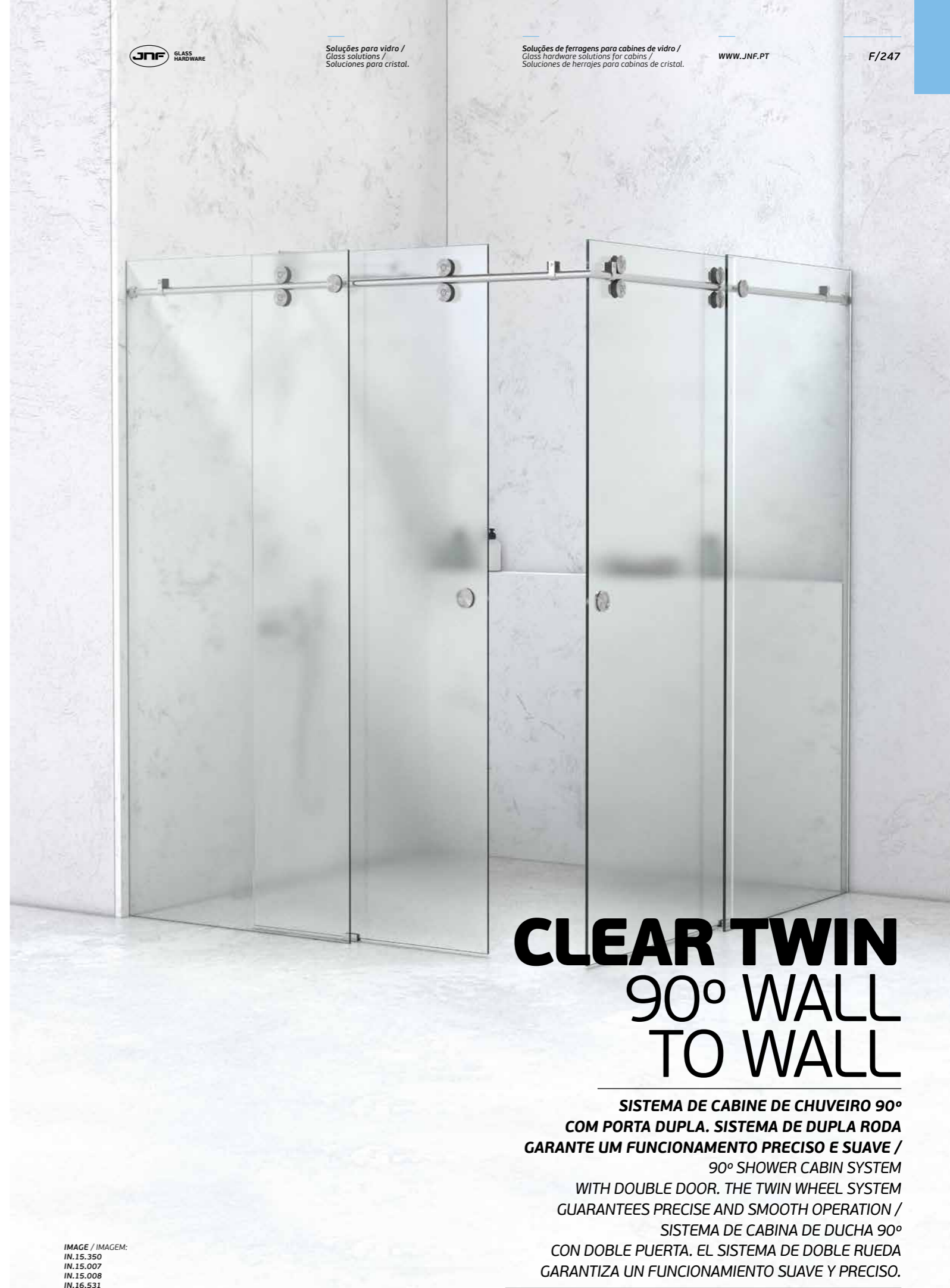
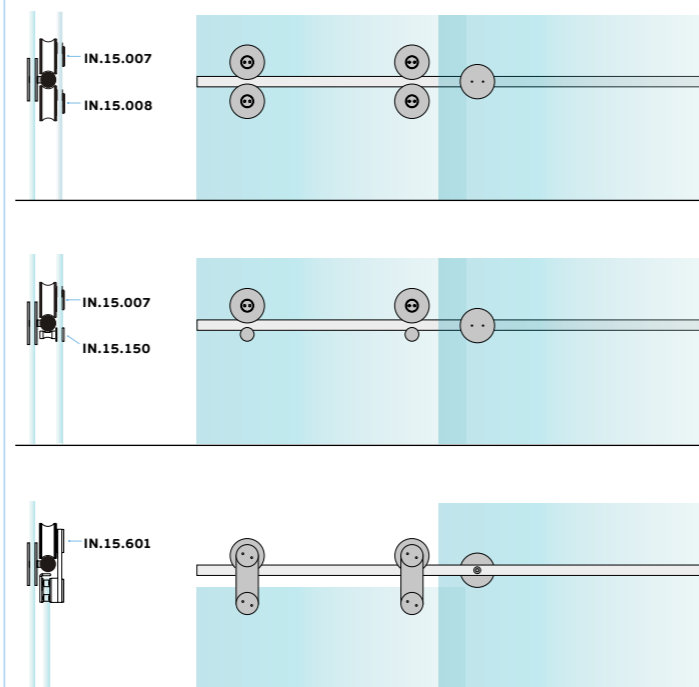

CLEAR TWIN 90° WALL TO WALL

**SISTEMA DE CABINE DE CHUVEIRO 90°
 COM PORTA DUPLA. SISTEMA DE DUPLA RODA
 GARANTE UM FUNCIONAMENTO PRECISO E SUAVE /
 90° SHOWER CABIN SYSTEM
 WITH DOUBLE DOOR. THE TWIN WHEEL SYSTEM
 GUARANTEES PRECISE AND SMOOTH OPERATION /
 SISTEMA DE CABINA DE DUCHA 90°
 CON DOBLE PUERTA. EL SISTEMA DE DOBLE RUEDA
 GARANTIZA UN FUNCIONAMIENTO SUAVE Y PRECISO.**

 IMAGEM / IMAGEM:
 IN.15.350
 IN.15.007
 IN.15.008
 IN.16.531

SOLUÇÕES DE FERRAGENS PARA CABINES DE VIDRO / GLASS HARDWARE SOLUTIONS FOR CABINS / SOLUCIONES DE HERRAJES PARA CABINAS DE CRISTAL

 IMAGEM / IMAGE :
 1x - IN.15.351.1
 1x - IN.15.007
 1x - IN.15.008

CLEAR TWIN System for glass

IN.15.351.1 (MÁX.1000mm)

IN.15.351.2 (MÁX. 2000mm)

- 1x - **Tubo 1000 / 2000mm (Ø25mm)** /
 Tube 1000 / 2000mm (Ø25mm) / Tubo 1000 / 2000mm (Ø25mm).
- 1x - **Suporte de tubo e parede** /
 Wall and tube support / Soporte de tubo e pared - **IN.15.028**
- 1x - **Suporte de tubo e vidro lateral** /
 Tube and lateral glass support / Tubo y soporte de cristal lateral - **IN.15.029**
- 1x - **Suporte de tubo e vidro fixo** /
 Tube and fixed glass support / Soporte de tubo e cristal fijo - **IN.15.017**
- 1x - **Conector e suporte** /
 Connector and support / Conector y soporte - **IN.15.011**

* Vidro e roldanas não incluídas / Glass and wheels not included / Cristal y ruedas no incluido *

RODAS COMPATÍVEIS SUITABLE WHEELS / RUEDAS COMPATIBLES

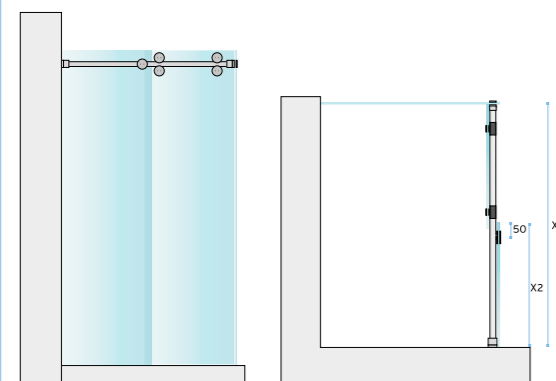
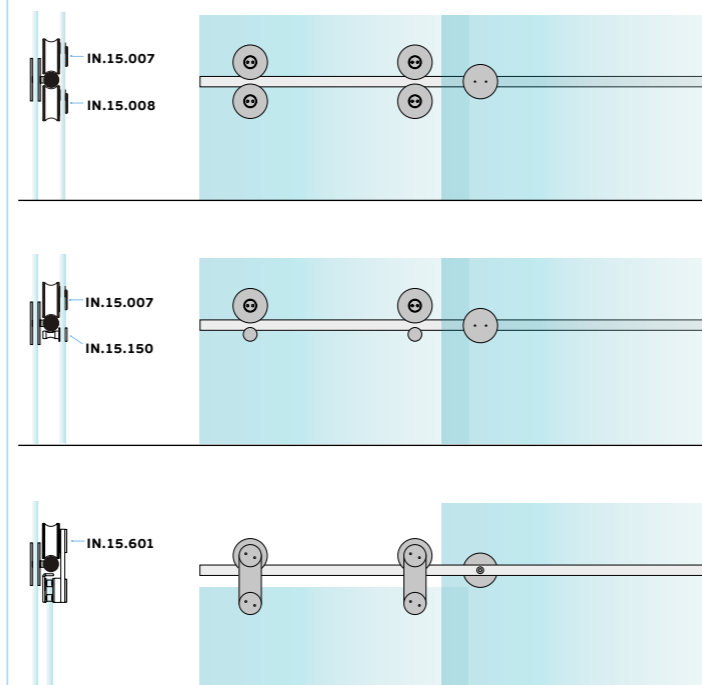

CLEAR TWIN 90° WALL TO GLASS

**SISTEMA DE CABINE DE CHUVEIRO 90°
 COM PORTA SIMPLES. ESTE SISTEMA PERMITE
 INSTALAR 3 TIPOS DE RODAS DIFERENTES /
 90° SHOWER CABIN SYSTEM WITH SINGLE DOOR. THIS
 SYSTEM ALLOWS YOU TO INSTALL 3 DIFFERENT TYPES OF
 WHEELS / SISTEMA DE CABINA DE DUCHA 90°
 CON PUERTA SIMPLES. ESTE SISTEMA PERMITE INSTALAR 3
 TIPOS DIFERENTES DE RUEDAS.**

 IMAGEM / IMAGEM:
 IN.15.351.1
 IN.15.007
 IN.15.008
 IN.16.531

SOLUÇÕES DE FERRAGENS PARA CABINES DE VIDRO / GLASS HARDWARE SOLUTIONS FOR CABINS / SOLUCIONES DE HERRAJES PARA CABINAS DE CRISTAL



IMAGEM / IMAGE :
1x - IN.15.352
1x - IN.15.007
1x - IN.15.008

CLEAR TWIN System for glass

IN.15.352 (MÁX. 2000mm)

- 1x - **Tubo 2000mm (Ø25mm)** /
Tube 2000mm (Ø25mm) / Tubo 2000mm (Ø25mm) - **IN.15.031**
- 2x - **Suporte de tubo e parede** /
Wall and tube support / Soporte de tubo e pared - **IN.15.028**
- 1x - **Conector e suporte de parede** /
Connector and wall support / Conector y soporte de pared - **IN.15.011**
- 1x - **Suporte de tubo e vidro fixo** /
Tube and fixed glass support / Soporte de tubo e cristal fijo - **IN.15.017**

* Vidro e roldanas não incluídas / Glass and wheels not included / Cristal y ruedas no incluido *

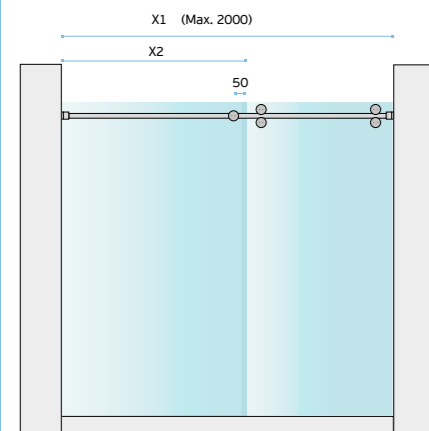

X1
Largura total
Total wide
Anchura total

X2 / X3
Largura vidro fixo
Fixed glass wide
Anchura del cristal fijo

Z1
Largura total
Total wide
Anchura total

Z2
Largura vidro fixo
Fixed glass wide
Anchura del cristal fijo

RODAS COMPATÍVEIS SUITABLE WHEELS / RUEDAS COMPATIBLES

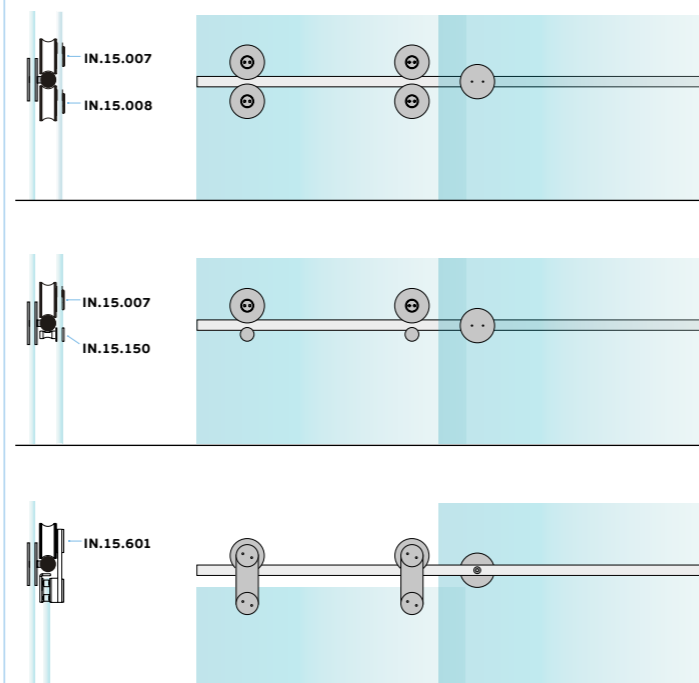

CLEAR TWIN 180° WALL TO WALL

**SISTEMA DE CABINE DE CHUVEIRO 180°
COM PORTA SIMPLES. ESTE SISTEMA PERMITE
INSTALAR 3 TIPOS DE RODAS DIFERENTES /
180° SHOWER CABIN SYSTEM WITH SINGLE DOOR. THIS
SYSTEM ALLOWS YOU TO INSTALL 3 DIFFERENT TYPES OF
WHEELS / SISTEMA DE CABINA DE DUCHA 180°
CON PUERTA SIMPLES. ESTE SISTEMA PERMITE INSTALAR 3
TIPOS DIFERENTES DE RUEDAS.**

IMAGE / IMAGEM:
IN.15.352
IN.15.007
IN.15.008
IN.15.601

SOLUÇÕES DE FERRAGENS PARA CABINES DE VIDRO / GLASS HARDWARE SOLUTIONS FOR CABINS / SOLUCIONES DE HERRAJES PARA CABINAS DE CRISTAL



 IMAGEM / IMAGE :
 1x - IN.15.353
 1x - IN.15.007
 1x - IN.15.008

CLEAR TWIN System for glass

IN.15.353 (MÁX. 2000mm)

- 1x - **Tubo 2000mm (Ø25mm)** /
Tube 2000mm (Ø25mm) / Tubo 2000mm (Ø25mm) - **IN.15.031**
- 2x - **Suporte de tubo e parede** /
Wall and tube support / Soporte de tubo e pared - **IN.15.028**
- 2x - **Conector e suporte de parede** /
Connector and wall support / Conector y soporte de pared - **IN.15.011**
- 2x - **Suporte de tubo e vidro fixo** /
Tube and fixed glass support / Soporte de tubo e cristal fijo - **IN.15.017**

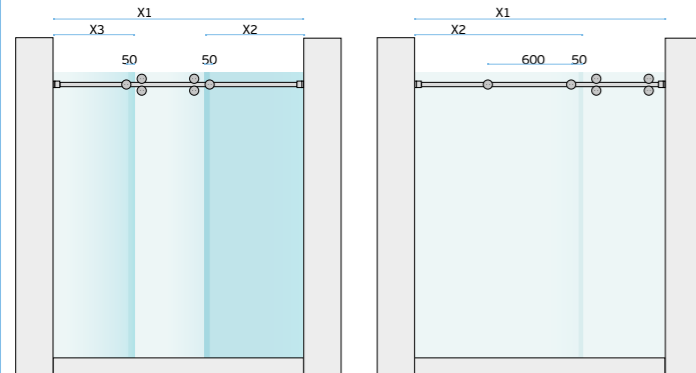
* Vidro e roldanas não incluídas / Glass and wheels not included / Cristal y ruedas no incluido *



X1 Largura total Total wide Anchura total	X2 / X3 Largura vidro fixo Fixed glass wide Anchura del cristal fijo	Z1 Largura total Total wide Anchura total	Z2 Largura vidro fixo Fixed glass wide Anchura del cristal fijo
---	--	---	---

RODAS COMPATÍVEIS SUITABLE WHEELS / RUEDAS COMPATIBLES

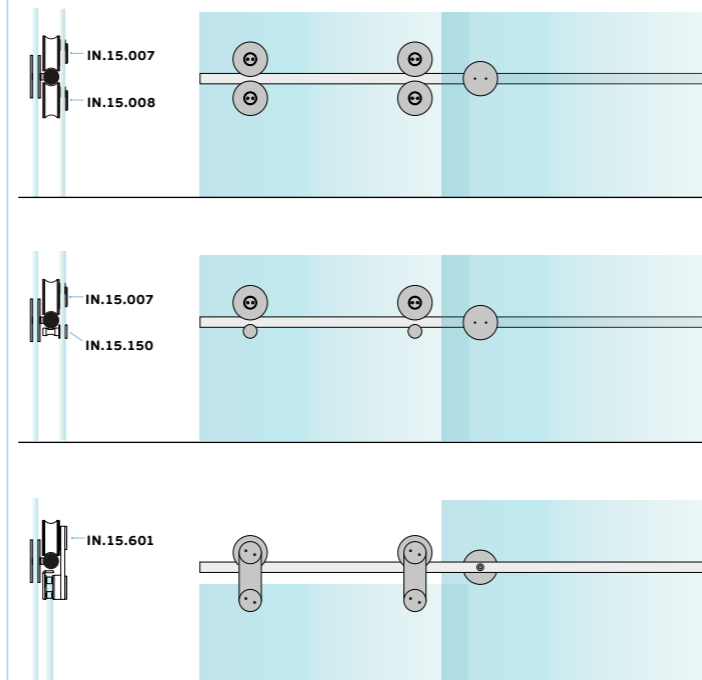

CLEAR TWIN 180° WALL TO WALL

**SISTEMA DE CABINE DE CHUVEIRO 180°
 COM PORTA SIMPLES. LARGURA MÁX. 2MT ESTE SISTEMA
 PERMITE INSTALAR 3 TIPOS DE RODAS DIFERENTES /
 180° SHOWER CABIN SYSTEM WITH SINGLE DOOR.
 MAX WIDE 2MT. THIS SYSTEM ALLOWS YOU
 TO INSTALL 3 DIFFERENT TYPES OF WHEELS /
 SISTEMA DE CABINA DE DUCHA 180° CON PUERTA SIMPLES.
 ANCHO MÁX. 2MT. ESTE SISTEMA PERMITE
 INSTALAR 3 TIPOS DIFERENTES DE RUEDAS.**

 IMAGE / IMAGEM:
 IN.15.353
 IN.15.007
 IN.15.008
 IN.15.531

SOLUÇÕES DE FERRAGENS PARA CABINES DE VIDRO / GLASS HARDWARE SOLUTIONS FOR CABINS / SOLUCIONES DE HERRAJES PARA CABINAS DE CRISTAL

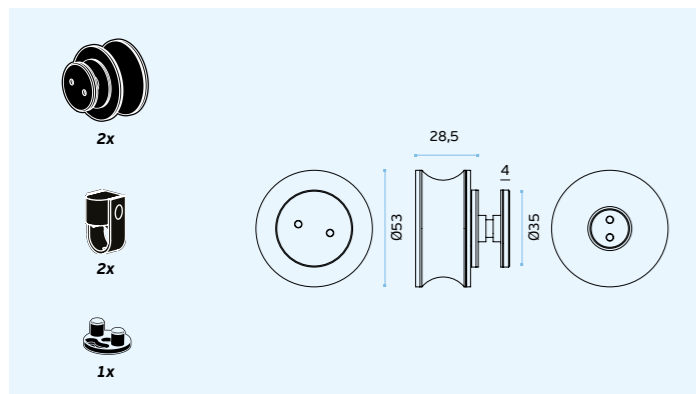

IN.15.007
CLEAR SYSTEM FOR GLASS



- 2x - **Roldanas** / Wheels / Ruedas
- 2x - **Batentes** / Stoppers / Frenos
- 1x - **Guia de pavimento** / Floor guide / Guia de suelo

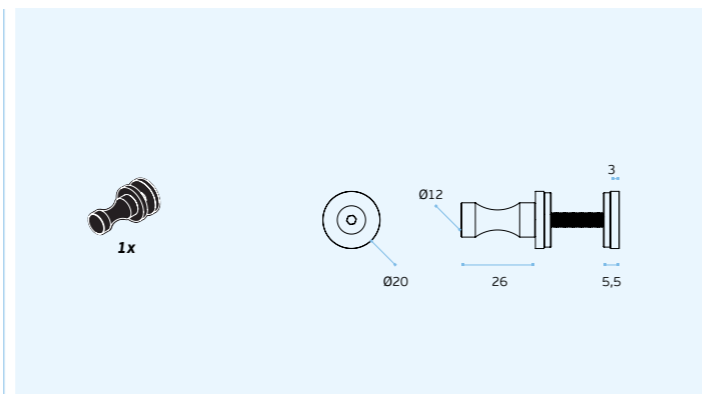
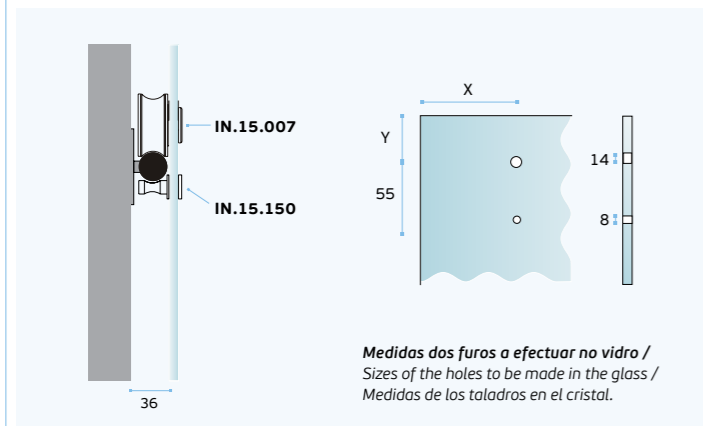

IN.15.150
CLEAR SYSTEM FOR GLASS



- 1x - **Pino de segurança** / Security pin / Pino de seguridad

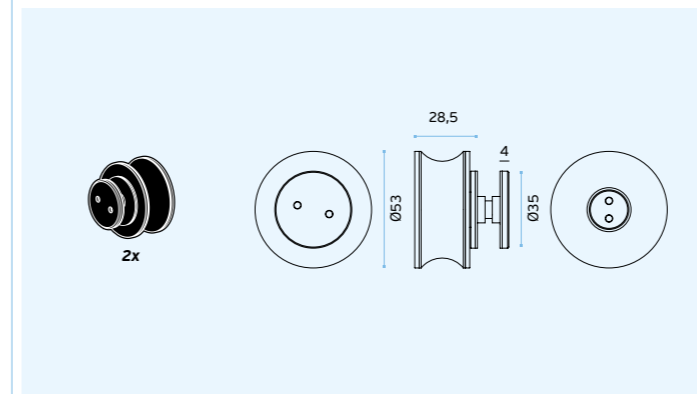
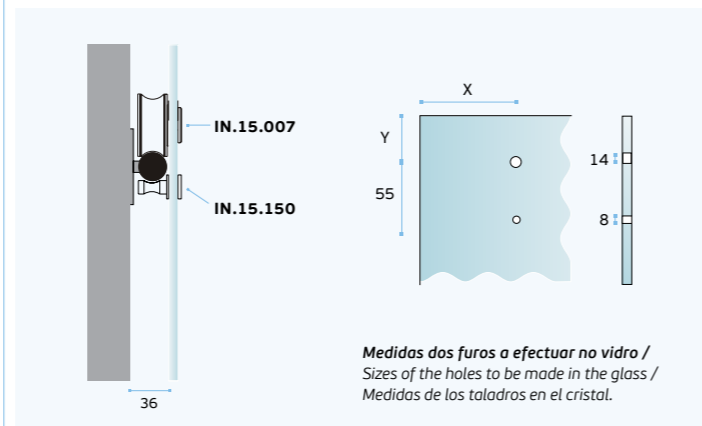

IN.15.008
CLEAR SYSTEM FOR GLASS



- 2x - **Roldanas** / Wheels / Ruedas

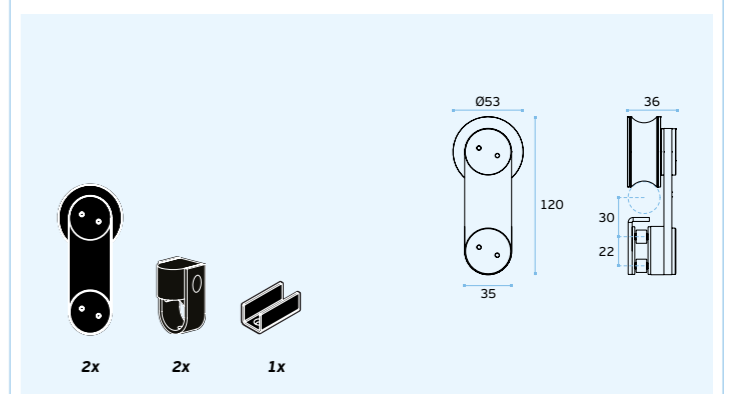
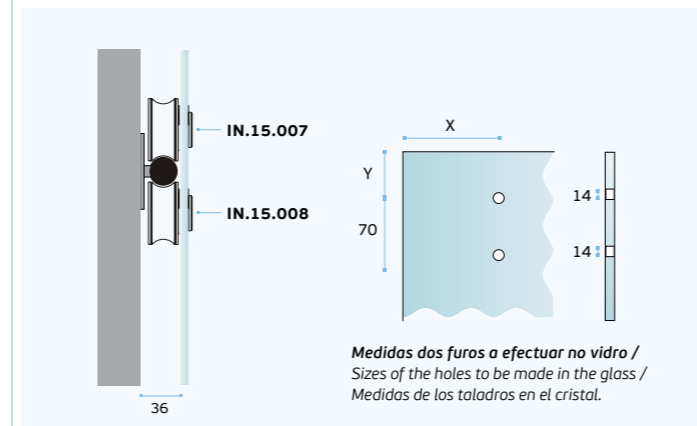

IN.15.601
A2 SYSTEM FOR GLASS



- 2x - **Roldanas** / Wheels / Ruedas
- 2x - **Batentes** / Stoppers / Frenos
- 1x - **Guia de pavimento** / Floor guide / Guia de suelo

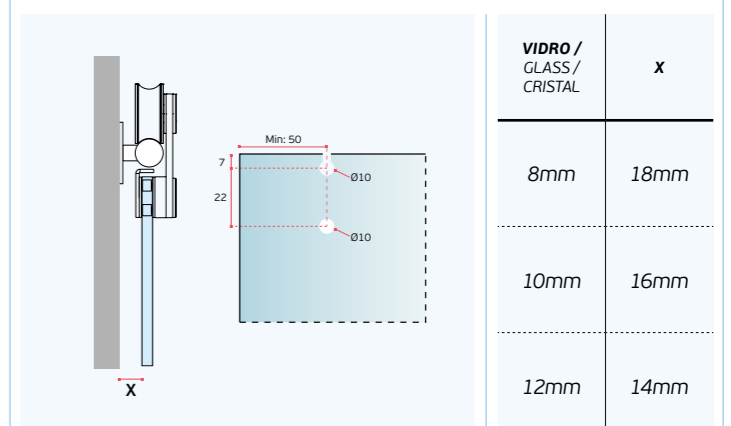

SISTEMAS DE DOBRADIÇAS E SUPORTES PARA VIDRO /
HINGE & SUPPORT SYSTEMS FOR GLASS /
SISTEMAS DE BISAGRAS Y SOPORTES PARA CRISTAL.

A Recomendado: 2 ou 3 dobradiças por porta /
Recommended: 2 or 3 hinges per door /
Recomendado: 2 o 3 bisagras por puerta.

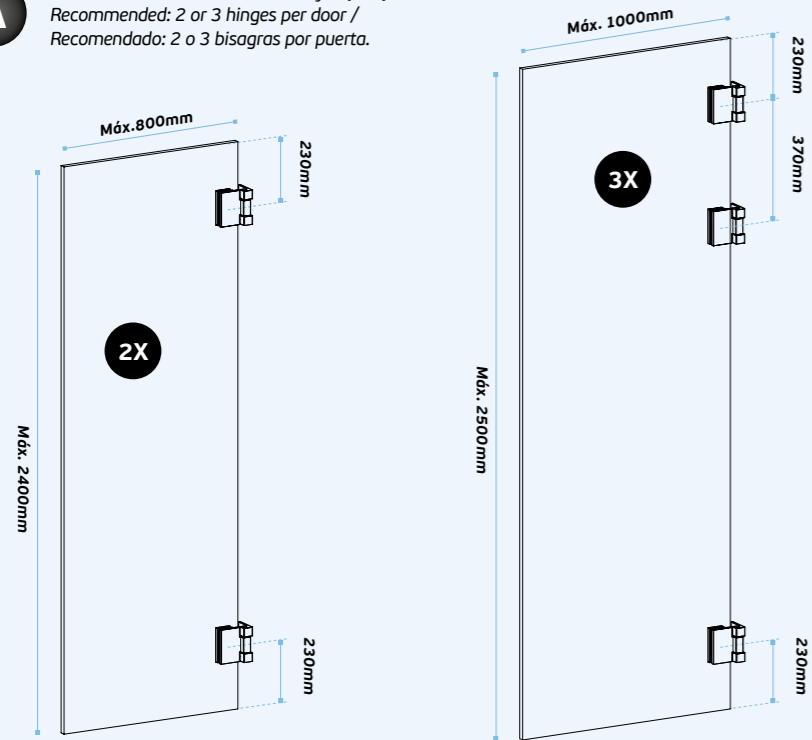

Para portas com medidas superiores - sob consulta /
For doors with superior dimensions - under request /
Para puertas con dimensiones superiores - sob pedido.

B Recomendado: 3 dobradiças por porta (vidro 8mm) /
Recommended: 3 hinges per door (glass 8mm) /
Recomendado: 3 bisagras por puerta (cristal 8mm).



Para portas com medidas superiores - sob consulta /
For doors with superior dimensions - under request /
Para puertas con dimensiones superiores - sob pedido.



SHOWER HINGES

DOBRADIÇAS E ACESSÓRIOS PARA CHUVEIROS /
HINGES AND ACCESSORIES FOR SHOWERS /
BISAGRAS Y ACCESORIOS PARA DUCHAS.

SISTEMAS DE DOBRADIÇAS E SUPORTES PARA VIDRO / HINGE & SUPPORT SYSTEMS FOR GLASS / SISTEMAS DE BISAGRAS Y SOPORTES PARA CRISTAL.

SATIN FINISH

EN 1.4301 - AISI 304



IN.05.311
 Dobradiça vidro - vidro,
 90° com paragem /
 Glass to glass hinge with stop 90° /
 Bisagra cristal - cristal 90° con freno.

MATERIAL: EN 1.4301 / AISI 304

ACABAMENTO / FINISH / ACABADO:

SATINADO / SATIN / SATIN

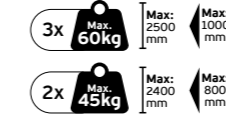

IN.05.308
 Dobradiça vidro-vidro
 com paragem /
 Glass to glass hinge with stop /
 Bisagra cristal-cristal con freno.

MATERIAL: EN 1.4301 / AISI 304

ACABAMENTO / FINISH / ACABADO:

SATINADO / SATIN / SATIN



IN.05.305
 Suporte de parede-vidro /
 Wall to glass support / Soporte pared-cristal.

MATERIAL: EN 1.4301 / AISI 304

ACABAMENTO / FINISH / ACABADO:

SATINADO / SATIN / SATIN

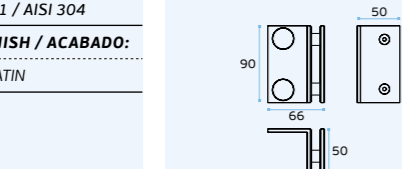

IN.05.306
 Dobradiça parede-vidro
 com paragem /
 Wall to glass hinge with stop /
 Bisagra pared-cristal con freno.

MATERIAL: EN 1.4301 / AISI 304

ACABAMENTO / FINISH / ACABADO:

SATINADO / SATIN / SATIN

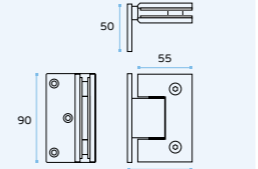

IN.05.307
 Dobradiça parede-vidro
 com paragem /
 Wall to glass hinge with stop /
 Bisagra pared-cristal con freno.

MATERIAL: EN 1.4301 / AISI 304

ACABAMENTO / FINISH / ACABADO:

SATINADO / SATIN / SATIN

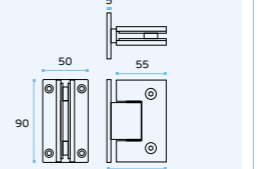

IN.05.308.D
 Dobradiça dupla, vidro - vidro,
 90° com paragem / Glass to glass
 double hinge with stop 90° / Bisagra
 doble - cristal - cristal 90° con freno.

MATERIAL: EN 1.4301 / AISI 304

ACABAMENTO / FINISH / ACABADO:

SATINADO / SATIN / SATIN

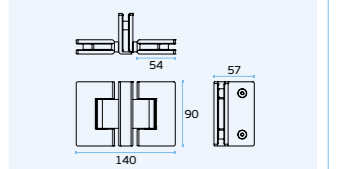

SISTEMAS DE DOBRADIÇAS E SUORTES PARA VIDRO /
HINGE & SUPPORT SYSTEMS FOR GLASS /
SISTEMAS DE BISAGRAS Y SOPORTES PARA CRISTAL.



MIRROR FINISH

EN 1.4301 - AISI 304



IN.05.311.P
Dobradiça vidro - vidro,
90° com paragem /
Glass to glass hinge with stop 90° /
Bisagra cristal - cristal 90° con freno.

3x **Max. 60kg** Max: 2500 mm Max: 1000 mm
 2x **Max. 45kg** Max: 2400 mm Max: 800 mm

MATERIAL: EN 1.4301 / AISI 304

ACABAMENTO / FINISH / ACABADO:

POLIDO / POLISHED / PULIDO

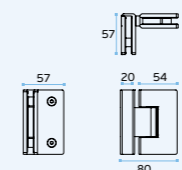

IN.05.308.P
Dobradiça vidro-vidro
com paragem /
Glass to glass hinge with stop /
Bisagra cristal-cristal con freno.

3x **Max. 60kg** Max: 2500 mm Max: 1000 mm
 2x **Max. 45kg** Max: 2400 mm Max: 800 mm

MATERIAL: EN 1.4301 / AISI 304

ACABAMENTO / FINISH / ACABADO:

POLIDO / POLISHED / PULIDO

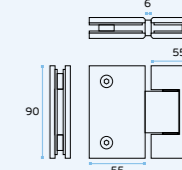

IN.05.305.P
Suporte de parede-vidro /
Wall to glass support / Soporte pared-cristal.

MATERIAL: EN 1.4301 / AISI 304

ACABAMENTO / FINISH / ACABADO:

POLIDO / POLISHED / PULIDO

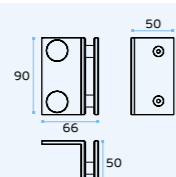

IN.05.306.P
Dobradiça parede-vidro
com paragem /
Wall to glass hinge with stop /
Bisagra pared-cristal con freno.

3x **Max. 60kg** Max: 2500 mm Max: 1000 mm
 2x **Max. 45kg** Max: 2400 mm Max: 800 mm

MATERIAL: EN 1.4301 / AISI 304

ACABAMENTO / FINISH / ACABADO:

POLIDO / POLISHED / PULIDO

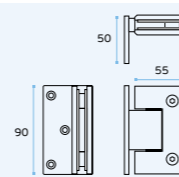

IN.05.307.P
Dobradiça parede-vidro
com paragem /
Wall to glass hinge with stop /
Bisagra pared-cristal con freno.

3x **Max. 60kg** Max: 2500 mm Max: 1000 mm
 2x **Max. 45kg** Max: 2400 mm Max: 800 mm

MATERIAL: EN 1.4301 / AISI 304

ACABAMENTO / FINISH / ACABADO:

POLIDO / POLISHED / PULIDO

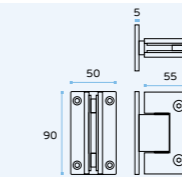

IN.05.308.D.P
Dobradiça dupla, vidro - vidro,
90° com paragem /
Glass to glass double hinge with stop 90° /
Bisagra doble - cristal - cristal 90° con freno.

3x **Max. 60kg** Max: 2500 mm Max: 1000 mm
 2x **Max. 45kg** Max: 2400 mm Max: 800 mm

MATERIAL: EN 1.4301 / AISI 304

ACABAMENTO / FINISH / ACABADO:

POLIDO / POLISHED / PULIDO

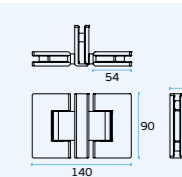

SISTEMAS DE DOBRADIÇAS E SUPORTES PARA VIDRO / HINGE & SUPPORT SYSTEMS FOR GLASS / SISTEMAS DE BISAGRAS Y SOPORTES PARA CRISTAL.



BLACK PVD TITANIUM

EN 1.4301 - AISI 304 + PVD TITANIUM BLACK



IN.05.311.TB
Dobradiça vidro - vidro,
90° com paragem /
Glass to glass hinge with stop 90° /
Bisagra cristal - cristal 90° con freno.

3x Max. 60kg Max: 2500 mm Max: 1000 mm
2x Max. 45kg Max: 2400 mm Max: 800 mm

MATERIAL: EN 1.4301 / AISI 304
FINISH: SATINADO / SATIN / SATIN
PVD TITANIUM BLACK

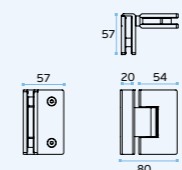

IN.05.308.TB
Dobradiça vidro-vidro
com paragem /
Glass to glass hinge with stop /
Bisagra cristal-cristal con freno.

3x Max. 60kg Max: 2500 mm Max: 1000 mm
2x Max. 45kg Max: 2400 mm Max: 800 mm

MATERIAL: EN 1.4301 / AISI 304
FINISH: SATINADO / SATIN / SATIN
PVD TITANIUM BLACK

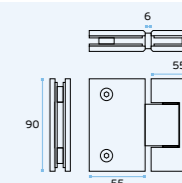

IN.05.305.TB
Suporte de parede-vidro /
Wall to glass support / Soporte pared-cristal.

MATERIAL: EN 1.4301 / AISI 304
FINISH: SATINADO / SATIN / SATIN
PVD TITANIUM BLACK

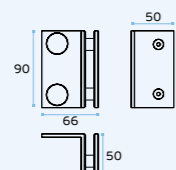

IN.05.306.TB
Dobradiça parede-vidro
com paragem /
Wall to glass hinge with stop /
Bisagra pared-cristal con freno.

MATERIAL: EN 1.4301 / AISI 304
FINISH: SATINADO / SATIN / SATIN
PVD TITANIUM BLACK

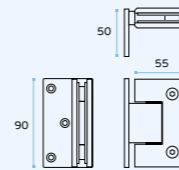

IN.05.307.TB
Dobradiça parede-vidro
com paragem /
Wall to glass hinge with stop /
Bisagra pared-cristal con freno.

MATERIAL: EN 1.4301 / AISI 304
FINISH: SATINADO / SATIN / SATIN
PVD TITANIUM BLACK

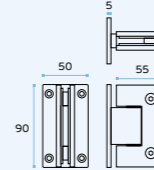

IN.05.308.D.TB
Dobradiça dupla, vidro - vidro,
90° com paragem / Glass to glass
double hinge with stop 90° / Bisagra
doble - cristal - cristal 90° con freno.

MATERIAL: EN 1.4301 / AISI 304
FINISH: SATINADO / SATIN / SATIN
PVD TITANIUM BLACK

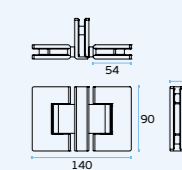

SISTEMAS DE DOBRADIÇAS E SUPORTES PARA VIDRO / HINGE & SUPPORT SYSTEMS FOR GLASS / SISTEMAS DE BISAGRAS Y SOPORTES PARA CRISTAL.



GOLD PVD TITANIUM

EN 1.4301 - AISI 304 + PVD TITANIUM GOLD



IN.05.311.TG
Dobradiça vidro - vidro,
90° com paragem /
Glass to glass hinge with stop 90° /
Bisagra cristal - cristal 90° con freno.

3x Max. 60kg Max: 2500 mm Max: 1000 mm
2x Max. 45kg Max: 2400 mm Max: 800 mm

MATERIAL: EN 1.4301 / AISI 304
FINISH: SATINADO / SATIN / SATIN
PVD TITANIUM GOLD

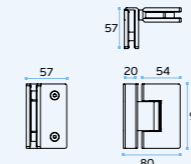

IN.05.308.TG
Dobradiça vidro-vidro
com paragem /
Glass to glass hinge with stop /
Bisagra cristal-cristal con freno.

3x Max. 60kg Max: 2500 mm Max: 1000 mm
2x Max. 45kg Max: 2400 mm Max: 800 mm

MATERIAL: EN 1.4301 / AISI 304
FINISH: SATINADO / SATIN / SATIN
PVD TITANIUM GOLD

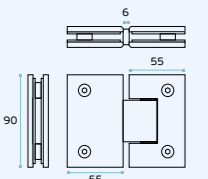
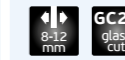

IN.05.305.TG
Suporte de parede-vidro /
Wall to glass support / Soporte pared-cristal.

MATERIAL: EN 1.4301 / AISI 304
FINISH: SATINADO / SATIN / SATIN
PVD TITANIUM GOLD

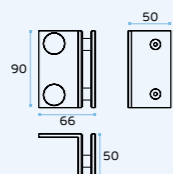

IN.05.306.TG
Dobradiça parede-vidro
com paragem /
Wall to glass hinge with stop /
Bisagra pared-cristal con freno.

MATERIAL: EN 1.4301 / AISI 304
FINISH: SATINADO / SATIN / SATIN
PVD TITANIUM GOLD

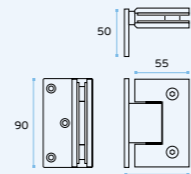

IN.05.307.TG
Dobradiça parede-vidro
com paragem /
Wall to glass hinge with stop /
Bisagra pared-cristal con freno.

MATERIAL: EN 1.4301 / AISI 304
FINISH: SATINADO / SATIN / SATIN
PVD TITANIUM GOLD

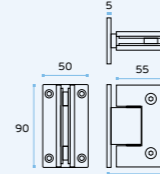

IN.05.308.D.TG
Dobradiça dupla, vidro - vidro,
90° com paragem / Glass to glass
double hinge with stop 90° / Bisagra
doble - cristal - cristal 90° con freno.

MATERIAL: EN 1.4301 / AISI 304
FINISH: SATINADO / SATIN / SATIN
PVD TITANIUM GOLD

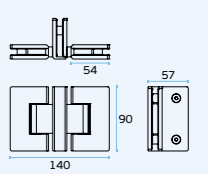

SISTEMAS DE DOBRADIÇAS E SUORTES PARA VIDRO / HINGE & SUPPORT SYSTEMS FOR GLASS / SISTEMAS DE BISAGRAS Y SOPORTES PARA CRISTAL.



COPPER PVD TITANIUM

EN 1.4301 - AISI 304 + PVD TITANIUM COPPER



IN.05.311.TCO
Dobradiça vidro - vidro, 90° com paragem / Glass to glass hinge with stop 90° / Bisagra cristal - cristal 90° con freno.



MATERIAL: EN 1.4301 / AISI 304
FINISH: SATINADO / SATIN / SATIN
PVD TITANIUM COPPER

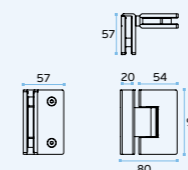

IN.05.308.TCO
Dobradiça vidro-vidro com paragem / Glass to glass hinge with stop / Bisagra cristal-cristal con freno.

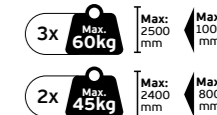

MATERIAL: EN 1.4301 / AISI 304
FINISH: SATINADO / SATIN / SATIN
PVD TITANIUM COPPER

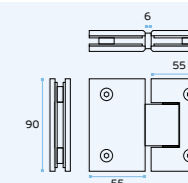

IN.05.305.TCO
Suporte de parede-vidro / Wall to glass support / Soporte pared-cristal.

MATERIAL: EN 1.4301 / AISI 304
FINISH: SATINADO / SATIN / SATIN
PVD TITANIUM COPPER

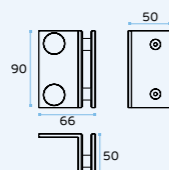

IN.05.306.TCO
Dobradiça parede-vidro com paragem / Wall to glass hinge with stop / Bisagra pared-cristal con freno.

MATERIAL: EN 1.4301 / AISI 304
FINISH: SATINADO / SATIN / SATIN
PVD TITANIUM COPPER

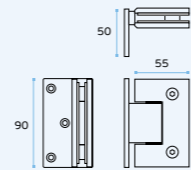

IN.05.307.TCO
Dobradiça parede-vidro com paragem / Wall to glass hinge with stop / Bisagra pared-cristal con freno.

MATERIAL: EN 1.4301 / AISI 304
FINISH: SATINADO / SATIN / SATIN
PVD TITANIUM COPPER

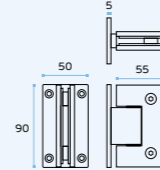

IN.05.308.D.TCO
Dobradiça dupla, vidro - vidro, 90° com paragem / Glass to glass double hinge with stop 90° / Bisagra doble - cristal - cristal 90° con freno.

MATERIAL: EN 1.4301 / AISI 304
FINISH: SATINADO / SATIN / SATIN
PVD TITANIUM COPPER

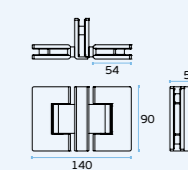

SISTEMAS DE DOBRADIÇAS E SUORTES PARA VIDRO / HINGE & SUPPORT SYSTEMS FOR GLASS / SISTEMAS DE BISAGRAS Y SOPORTES PARA CRISTAL.

HYDRAULIC
SYSTEMsoft
closing

A

IN.05.315

Dobradiça hidráulica, parede - vidro /
Hydraulic glass to wall hinge /
Bisagra hidráulica pared - cristal.



MATERIAL: EN 1.4301 / AISI 304

ACABAMENTO / FINISH / ACABADO:

SATINADO / SATIN / SATIN

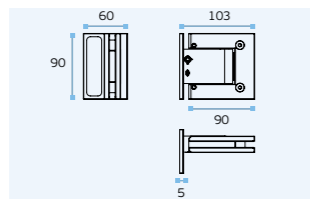
HYDRAULIC
SYSTEMsoft
closing

A

IN.05.316

Dobradiça hidráulica, vidro - vidro /
Hydraulic glass to glass hinge /
Bisagra hidráulica, cristal - cristal.



MATERIAL: EN 1.4301 / AISI 304

ACABAMENTO / FINISH / ACABADO:

SATINADO / SATIN / SATIN

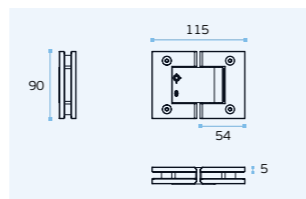
HYDRAULIC
SYSTEMsoft
closing

A

IN.05.315.P

Dobradiça hidráulica, parede - vidro /
Hydraulic glass to wall hinge /
Bisagra hidráulica pared - cristal.



MATERIAL: EN 1.4301 / AISI 304

ACABAMENTO / FINISH / ACABADO:

POLIDO / MIRROR / PULIDO

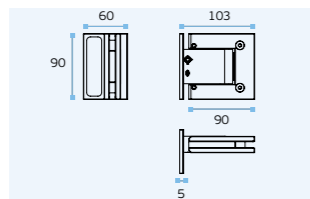
HYDRAULIC
SYSTEMsoft
closing

A

IN.05.316.P

Dobradiça hidráulica, vidro - vidro /
Hydraulic glass to glass hinge /
Bisagra hidráulica, cristal - cristal.



MATERIAL: EN 1.4301 / AISI 304

ACABAMENTO / FINISH / ACABADO:

POLIDO / MIRROR / PULIDO

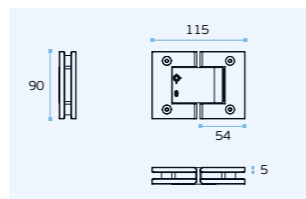

SELF CLOSING SHOWER HINGES

**DOBRADIÇAS HIDRÁULICAS COM
FECHO SUAVE E FORÇA AJUSTÁVEL /
HYDRAULIC HINGES WITH SOFT CLOSING
AND POWER ADJUSTMENT / BISAGRAS HIDRÁULICAS
CON CIERRE SUAVE Y AJUSTE DE FUERZA .**

HYDRAULIC
SYSTEM

SISTEMAS DE DOBRADIÇAS E SUORTES PARA VIDRO / HINGE & SUPPORT SYSTEMS FOR GLASS / SISTEMAS DE BISAGRAS Y SOPORTES PARA CRISTAL.



HYDRAULIC SYSTEM
soft closing

IN.05.315.TB
Dodradiça hidráulica, parede - vidro/
Hidraulic glass to wall hinge /
Bisagra hidraulica pared - cristal.

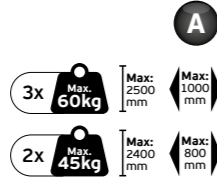

MATERIAL: EN 1.4301 / AISI 304
FINISH: SATINADO / SATIN / SATIN
PVD TITANIUM BLACK

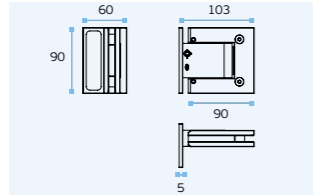

HYDRAULIC SYSTEM
soft closing

IN.05.316.TB
Dodradiça hidráulica, vidro - vidro/
Hidraulic glass to glass hinge /
Bisagra hidraulica, cristal - cristal.

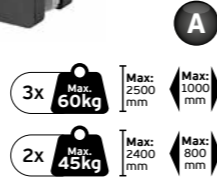

MATERIAL: EN 1.4301 / AISI 304
FINISH: SATINADO / SATIN / SATIN
PVD TITANIUM BLACK

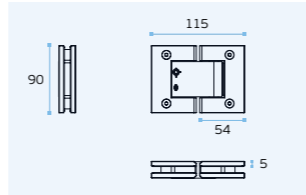

HYDRAULIC SYSTEM
soft closing

IN.05.315.TCO
Dodradiça hidráulica, parede - vidro/
Hidraulic glass to wall hinge /
Bisagra hidraulica pared - cristal.

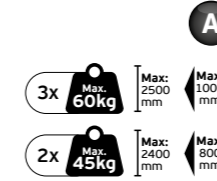

MATERIAL: EN 1.4301 / AISI 304
FINISH: SATINADO / SATIN / SATIN
PVD TITANIUM COPPER

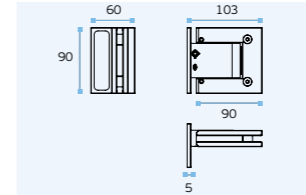

HYDRAULIC SYSTEM
soft closing

IN.05.316.TCO
Dodradiça hidráulica, vidro - vidro/
Hidraulic glass to glass hinge /
Bisagra hidraulica, cristal - cristal.

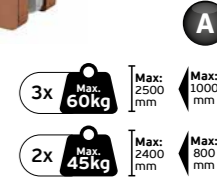

MATERIAL: EN 1.4301 / AISI 304
FINISH: SATINADO / SATIN / SATIN
PVD TITANIUM COPPER

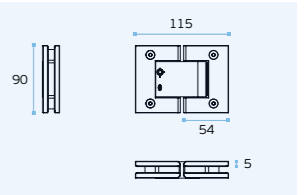

HYDRAULIC SYSTEM
soft closing

IN.05.315.TG
Dodradiça hidráulica, parede - vidro/
Hidraulic glass to wall hinge /
Bisagra hidraulica pared - cristal.

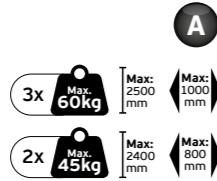

MATERIAL: EN 1.4301 / AISI 304
FINISH: SATINADO / SATIN / SATIN
PVD TITANIUM GOLD

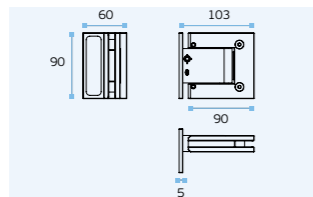

HYDRAULIC SYSTEM
soft closing

IN.05.316.TG
Dodradiça hidráulica, vidro - vidro/
Hidraulic glass to glass hinge /
Bisagra hidraulica, cristal - cristal.

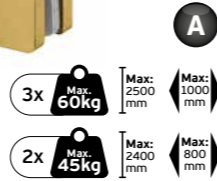

MATERIAL: EN 1.4301 / AISI 304
FINISH: SATINADO / SATIN / SATIN
PVD TITANIUM GOLD

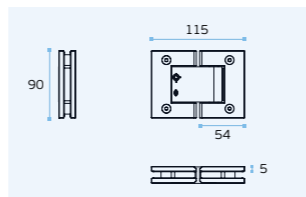

HYDRAULIC SYSTEM
soft closing

IN.05.315.TCH
Dodradiça hidráulica, parede - vidro/
Hidraulic glass to wall hinge /
Bisagra hidraulica pared - cristal.

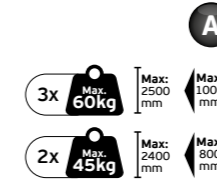

MATERIAL: EN 1.4301 / AISI 304
FINISH: SATINADO / SATIN / SATIN
PVD TITANIUM CHOCOLATE

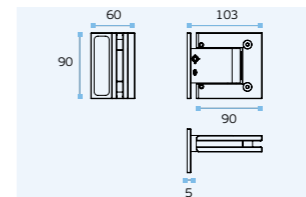

HYDRAULIC SYSTEM
soft closing

IN.05.316.TCH
Dodradiça hidráulica, vidro - vidro/
Hidraulic glass to glass hinge /
Bisagra hidraulica, cristal - cristal.

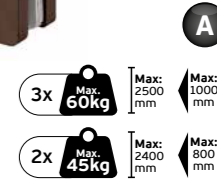

MATERIAL: EN 1.4301 / AISI 304
FINISH: SATINADO / SATIN / SATIN
PVD TITANIUM CHOCOLATE

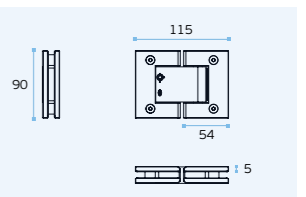

SISTEMAS DE DOBRADIÇAS E SUPORTES PARA VIDRO /
HINGE & SUPPORT SYSTEMS FOR GLASS /
SISTEMAS DE BISAGRAS Y SOPORTES PARA CRISTAL.



THE SQUARE SHOWER HINGE

EN 1.4301 - AISI 304 - 90MM X 90MM



IN.80.600
Sistema de suporte de vidro à parede /
Support system glass to wall /
Sistema de soporte de cristal a la pared.



REF	X
IN.80.600.700	700 mm
IN.80.600.800	800 mm
IN.80.600.900	900 mm
IN.80.600.1000	1000 mm

IN.80.600.E._____
DISCRIMINAR A MEDIDA /
ORDER THE NECESSARY DIMENSION /
DISCRIMINAR LA MEDIDA.

MATERIAL: EN 1.4301 / AISI 304

ACABAMENTO / FINISH / ACABADO:
STANDARD: SATINADO / SATIN / SATIN

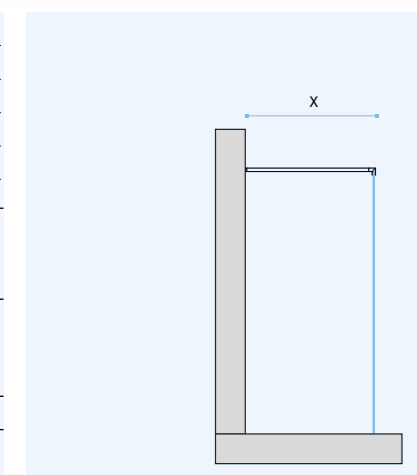

IN.05.303
Dobradiça parede-vidro
com paragem /
Wall to glass hinge with stop /
Bisagra pared-cristal con freno.

Qtd	Max Weight	Max Height	Max Width
3x	60kg	2500 mm	1000 mm
2x	45kg	2400 mm	800 mm

MATERIAL: EN 1.4301 / AISI 304
ACABAMENTO / FINISH / ACABADO:
SATINADO / SATIN / SATIN

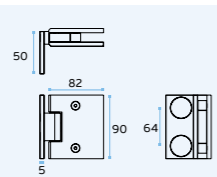

IN.05.304
Dobradiça com mola vidro - vidro
com paragem / Glass to glass spring
hinge with stop / Bisagra con muelle
cristal cristal con freno.

Qtd	Max Weight	Max Height	Max Width
3x	60kg	2500 mm	1000 mm
2x	45kg	2400 mm	800 mm

MATERIAL: EN 1.4301 / AISI 304
ACABAMENTO / FINISH / ACABADO:
SATINADO / SATIN / SATIN

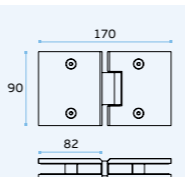

IN.80.60_
Sistema de suporte de vidro à parede /
Support system glass to wall /
Sistema de soporte de cristal a la pared.

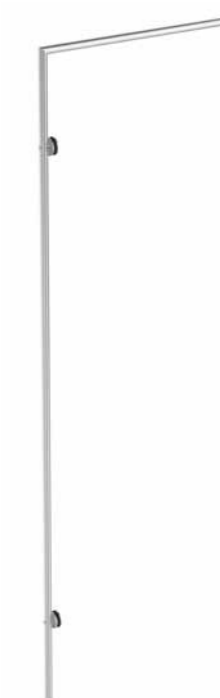

MATERIAL: EN 1.4301 / AISI 304
ACABAMENTO / FINISH / ACABADO:
STANDARD: SATINADO / SATIN / SATIN

REF	X
IN.80.601	700
IN.80.602	800
IN.80.603	900
IN.80.604	1000

IN.80.605
DISCRIMINAR A MEDIDA /
ORDER THE NECESSARY DIMENSION /
DISCRIMINAR LA MEDIDA.

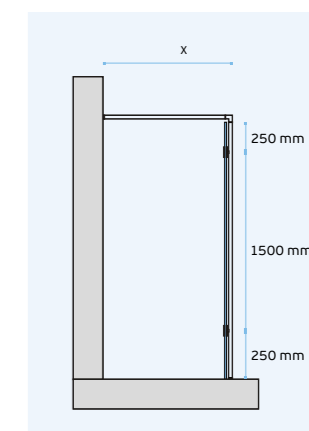

SISTEMAS DE DOBRADIÇAS E SUORTES PARA VIDRO /
HINGE & SUPPORT SYSTEMS FOR GLASS /
SISTEMAS DE BISAGRAS Y SOPORTES PARA CRISTAL.

MODULAR STABILIZER



ESTABILIZADORES MODULARES
 MODULAR STABILIZERS
 ESTABILIZADORES MODULARES



IN.80.660.500
IN.80.660.1000
IN.80.660.2000
IN.80.660.3000
Tubo rectangular 20x10mm /
 Rectangular tube 20x10mm/
 Tubo rectangular 20x10mm.

IN.80.660.500.P
IN.80.660.1000.P
IN.80.660.2000.P
IN.80.660.3000.P
Tubo rectangular 20x10mm /
 Rectangular tube 20x10mm/
 Tubo rectangular 20x10mm.

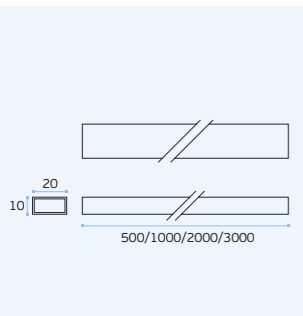
MATERIAL: EN 1.4301 / AISI 304
ACABAMENTO / FINISH / ACABADO:
STANDARD: SATINADO + POLIDO / SATIN + POLISHED / SATIN + PULIDO

IN.80.658
Suporte de tubo ao vidro /
 Glass support for tube /
 Soporte de tubo al cristal.

IN.80.658.P
Suporte de tubo ao vidro /
 Glass support for tube /
 Soporte de tubo al cristal.

MATERIAL: EN 1.4301 / AISI 304
ACABAMENTO / FINISH / ACABADO:
STANDARD: SATINADO + POLIDO / SATIN + POLISHED / SATIN + PULIDO



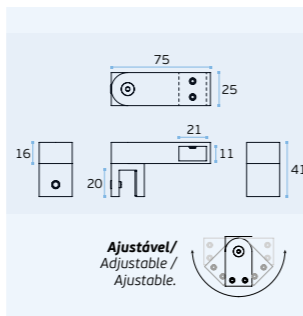

Ajustável / Adjustable / Ajustable.



IN.80.650
Suporte de tubo à parede /
 Wall support for tube /
 Soporte de tubo a la pared.

IN.80.650.P
Suporte de tubo à parede /
 Wall support for tube /
 Soporte de tubo a la pared.

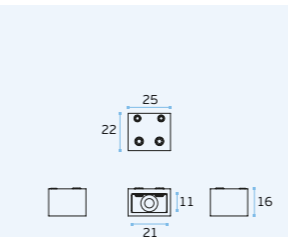

MATERIAL: EN 1.4301 / AISI 304
ACABAMENTO / FINISH / ACABADO:
STANDARD: SATINADO + POLIDO / SATIN + POLISHED / SATIN + PULIDO

IN.80.651 (180°)
Suporte de tubo ao vidro /
 Glass support for tube /
 Soporte de tubo al cristal.

IN.80.651.P (180°)
Suporte de tubo ao vidro /
 Glass support for tube /
 Soporte de tubo al cristal.

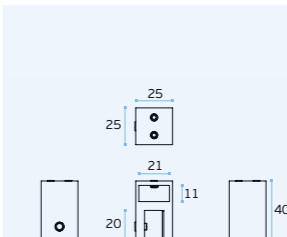

MATERIAL: EN 1.4301 / AISI 304
ACABAMENTO / FINISH / ACABADO:
STANDARD: SATINADO + POLIDO / SATIN + POLISHED / SATIN + PULIDO

IN.80.652 (90°)
Suporte de tubo ao vidro /
 Glass support for tube /
 Soporte de tubo al cristal.

IN.80.652.P (90°)
Suporte de tubo ao vidro /
 Glass support for tube /
 Soporte de tubo al cristal.

MATERIAL: EN 1.4301 / AISI 304
ACABAMENTO / FINISH / ACABADO:
STANDARD: SATINADO + POLIDO / SATIN + POLISHED / SATIN + PULIDO

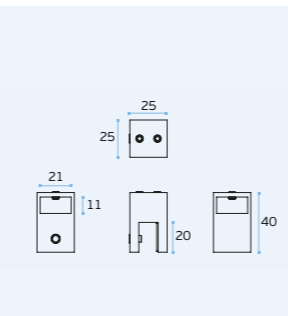
IN.80.653 (90°)
Suporte de tubo ao vidro /
 Glass support for tube /
 Soporte de tubo al cristal.

IN.80.653.P (90°)
Suporte de tubo ao vidro /
 Glass support for tube /
 Soporte de tubo al cristal.

MATERIAL: EN 1.4301 / AISI 304
ACABAMENTO / FINISH / ACABADO:
STANDARD: SATINADO + POLIDO / SATIN + POLISHED / SATIN + PULIDO

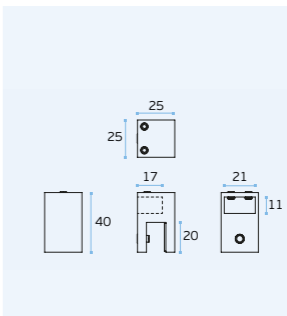

SISTEMAS DE DOBRADIÇAS E SUPORTES PARA VIDRO /
HINGE & SUPPORT SYSTEMS FOR GLASS /
SISTEMAS DE BISAGRAS Y SOPORTES PARA CRISTAL.



IN.80.654
Conector de tubo /
 Tube connector /
 Conector de tubo.

IN.80.654.P
Conector de tubo /
 Tube connector /
 Conector de tubo.

.P

MATERIAL: EN 1.4301 / AISI 304
ACABAMENTO / FINISH / ACABADO:
STANDARD: SATINADO + POLIDO /
 SATIN + POLISHED / SATIN + PULIDO

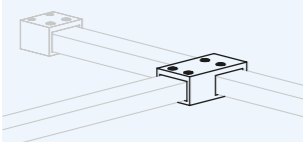
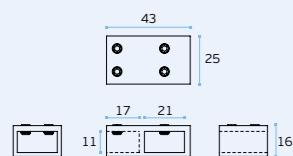

IN.80.655
Suporte de tubo à parede /
 Wall support for tube /
 Soporte de tubo a la pared.

IN.80.655.P
Suporte de tubo à parede /
 Wall support for tube /
 Soporte de tubo a la pared.

.P

MATERIAL: EN 1.4301 / AISI 304

ACABAMENTO / FINISH / ACABADO:
STANDARD: SATINADO + POLIDO /
 SATIN + POLISHED / SATIN + PULIDO

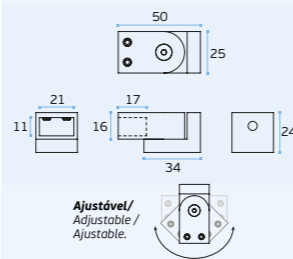

Ajustável/
 Adjustable /
 Ajustable.

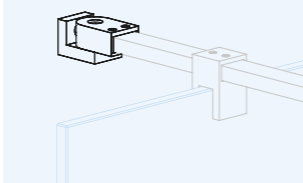

IN.80.656
Conector de tubo /
 Tube connector /
 Conector de tubo.

IN.80.656.P
Conector de tubo /
 Tube connector /
 Conector de tubo.

.P

MATERIAL: EN 1.4301 / AISI 304
ACABAMENTO / FINISH / ACABADO:
STANDARD: SATINADO + POLIDO /
 SATIN + POLISHED / SATIN + PULIDO

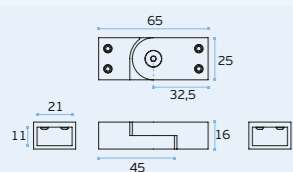

Ajustável/
 Adjustable /
 Ajustable.

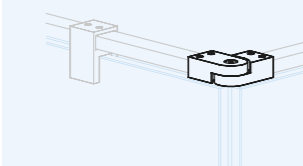

IN.80.657
Suporte de tubo ao vidro /
 Glass support for tube /
 Soporte de tubo al cristal.

IN.80.657.P
Suporte de tubo ao vidro /
 Glass support for tube /
 Soporte de tubo al cristal.

.P

8-10 mm NO glass cut

MATERIAL: EN 1.4301 / AISI 304

ACABAMENTO / FINISH / ACABADO:
STANDARD: SATINADO + POLIDO /
 SATIN + POLISHED / SATIN + PULIDO

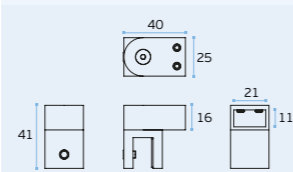

Ajustável/
 Adjustable /
 Ajustable.

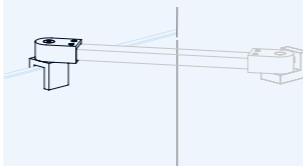

AERIAL CONNECTORS FOR GLASS

SISTEMA MODULAR RETANGULAR PARA CONECTORES DE VIDRO
 RECTANGULAR MODULAR SYSTEM FOR GLASS CONNECTORS /
 SISTEMA MODULAR RECTANGULAR PARA CONECTORES DE VIDRIO.

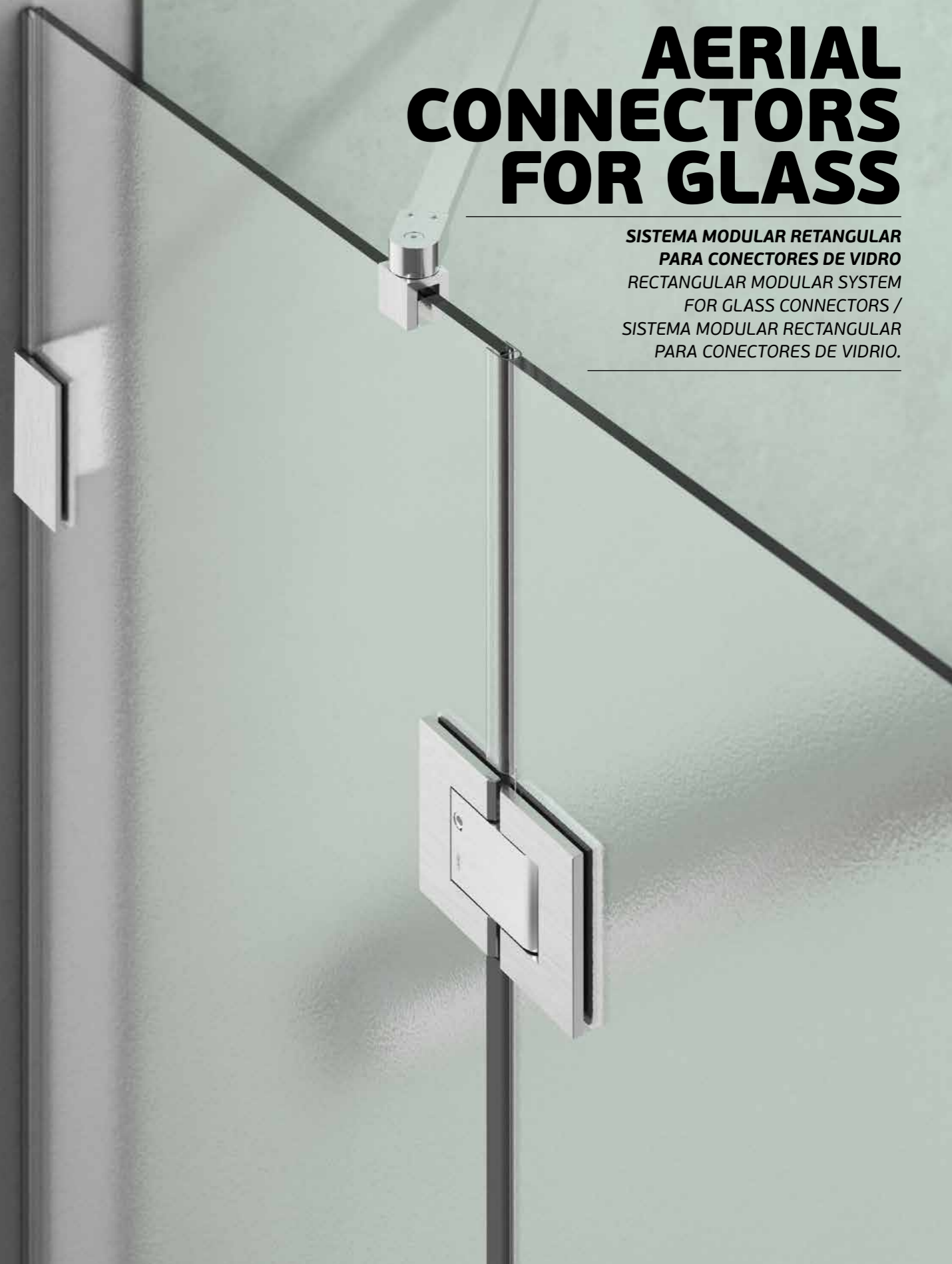

SOLUÇÕES DE FERRAGENS PARA CABINES DE VIDRO / GLASS HARDWARE SOLUTIONS FOR CABINS / SOLUCIONES DE HERRAJES PARA CABINAS DE CRISTAL

A JNF desenvolveu uma série de ferragens, para a construção de partições em vidro temperado ou laminado. A modularidade dos sistemas permite satisfazer mesmo as mais complexas estruturas. Com a simplicidade e transparência do vidro como motivação, o resultado foi peças discretas, com formas coerentes entre elas, mas tendo sempre em mente a função estrutural que garante o funcionamento e ligação entre os vidros.

JNF has developed a series of hardware for tempered or laminated glass partitions. The modularity of the system allows to build even the most complex structures. With the simplicity and transparency of the glass as the motivation, the results were discrete parts, with consistent shapes, but always taking into account the structural function that guarantees the function and connection between the glasses.

JNF ha desarrollado una serie de herrajes para crear particiones de cristal templado o laminado. La modularidad de los sistemas permite hacer incluso las estructuras más complejas. Con la sencillez y la transparencia del cristal como la motivación los resultados fueron discretas piezas, con formas coherentes, pero siempre teniendo en cuenta el factor estructural que garantiza la función y la conexión entre los cristales.



GLASS CABINET SOLUTIONS

A MODULARIDADE DOS SISTEMAS PERMITE SATISFAZER
 MESMO AS MAIS COMPLEXAS ESTRUTURAS /
 THE MODULARITY OF THE SYSTEM ALLOWS TO BUILD
 EVEN THE MOST COMPLEX STRUCTURES /
 LA MODULARIDAD DE LOS SISTEMAS PERMITE HACER
 INCLUSO LAS ESTRUCTURAS MÁS COMPLEJAS.

SOLUÇÕES DE FERRAGENS PARA CABINES DE VIDRO / GLASS HARDWARE SOLUTIONS FOR CABINS / SOLUCIONES DE HERRAJES PARA CABINAS DE CRISTAL



IN.75.105
Suporte parede - vidro /
Wall - glass connector /
Soporte pared - cristal.



MATERIAL: EN 1.4301 / AISI 304
ACABAMENTO / FINISH / ACABADO:
SATINADO / SATIN / SATIN

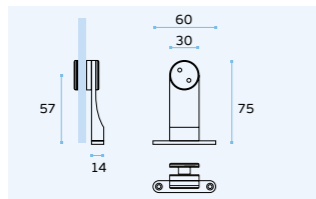

IN.75.001
Suporte vidro - vidro /
Glass - glass connector /
Soporte cristal - cristal.



MATERIAL: EN 1.4301 / AISI 304
ACABAMENTO / FINISH / ACABADO:
SATINADO / SATIN / SATIN

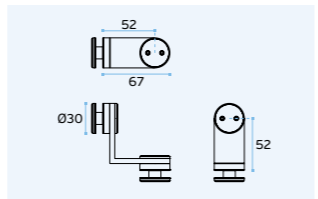

IN.75.002
Suporte vidro - vidro /
Glass - glass connector /
Soporte cristal - cristal.



MATERIAL: EN 1.4301 / AISI 304
ACABAMENTO / FINISH / ACABADO:
SATINADO / SATIN / SATIN

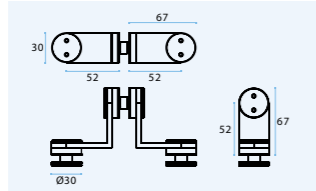

IN.75.003
Suporte pavimento ou tecto - vidro /
Ground or ceiling - glass connector /
Soporte suelo o techo - cristal.



MATERIAL: EN 1.4301 / AISI 304
ACABAMENTO / FINISH / ACABADO:
SATINADO / SATIN / SATIN

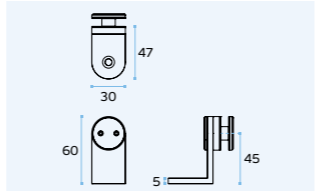

IN.75.009.90
Dobradiça para vidro, com limitador de abertura a 90° / Hinge for glass, with maximum opening at 90° / Bisagra para cristal, Con limitacion en la apertura a 90°.



MATERIAL: EN 1.4301 / AISI 304
ACABAMENTO / FINISH / ACABADO:
SATINADO / SATIN / SATIN

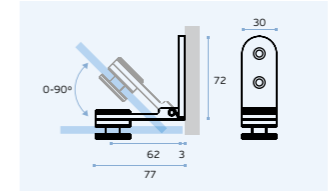

IN.75.007
Dobradiça vidro - vidro /
Glass to glass hinge /
Bisagra cristal - cristal.



MATERIAL: EN 1.4301 / AISI 304
ACABAMENTO / FINISH / ACABADO:
SATINADO / SATIN / SATIN

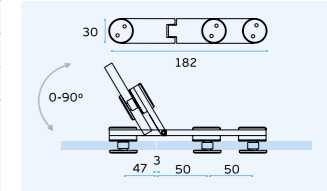

IN.75.005
Suporte vidro - vidro /
Glass - glass connector /
Soporte cristal - cristal.



MATERIAL: EN 1.4301 / AISI 304
ACABAMENTO / FINISH / ACABADO:
SATINADO / SATIN / SATIN

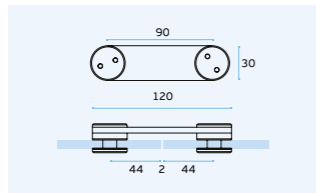

IN.75.009
Dobradiça para vidro /
Hinge for glass /
Bisagra para cristal.



MATERIAL: EN 1.4301 / AISI 304
ACABAMENTO / FINISH / ACABADO:
SATINADO / SATIN / SATIN

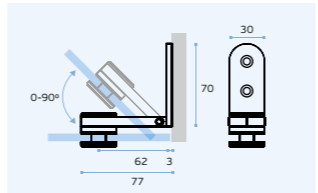

IN.75.101
Dobradiça com paragem para vidro / Hinge with stop for glass / Bisagra con freno para cristal.



MATERIAL: EN 1.4301 / AISI 304
ACABAMENTO / FINISH / ACABADO:
SATINADO / SATIN / SATIN

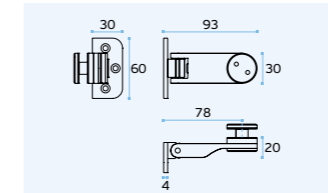

IN.75.103
Dobradiça com paragem para vidro / Hinge with stop for glass / Bisagra con freno para cristal.



MATERIAL: EN 1.4301 / AISI 304
ACABAMENTO / FINISH / ACABADO:
SATINADO / SATIN / SATIN

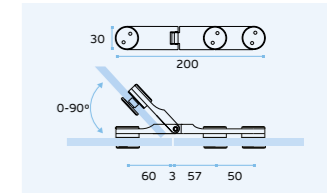

SISTEMAS DE DOBRADIÇAS E SUPORTES PARA VIDRO / HINGE & SUPPORT SYSTEMS FOR GLASS / SISTEMAS DE BISAGRAS Y SOPORTES PARA CRISTAL.

SM.013

Suporte de vidro para tubo /
Glass support for tube/
Soporte de cristal para tubo.



MATERIAL: EN 1.4301 / AISI 304

ACABAMENTO / FINISH / ACABADO:
STANDARD: SATINADO / SATIN / SATIN

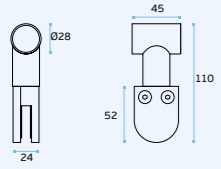

SM.018

Suporte de pavimento para vidro /
Floor support for glass /
Soporte de suelo para cristal.



MATERIAL: EN 1.4301 / AISI 304

ACABAMENTO / FINISH / ACABADO:
STANDARD: SATINADO / SATIN / SATIN

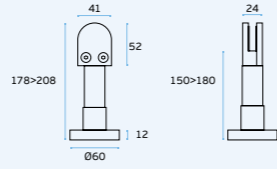

SM.010.A.25.2000

Tubo Ø25 com 2000mm /
Tube Ø25 with 2000mm /
Tubo Ø25 con 2000mm.



MATERIAL: EN 1.4301 / AISI 304

ACABAMENTO / FINISH / ACABADO:
SATINADO / SATIN / SATIN



SM.010.A.25.2000.TB

PVD TITANIUM Black

SM.010.A.25.2000.TG

PVD TITANIUM Gold

SM.010.A.25.2000.TCO

PVD TITANIUM Copper



SM.015

União de tubo a 90° para tubo
Ø25mm / Tube connector at 90° for
Ø25mm tube / Unión de tubo a 90°
para tubo Ø25mm.



MATERIAL: EN 1.4301 / AISI 304

ACABAMENTO / FINISH / ACABADO:
STANDARD: SATINADO / SATIN / SATIN

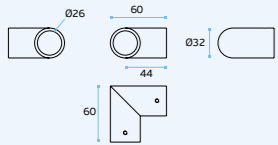

SM.011.25

Suporte de tubo com fixação
à parede / Wall mounting tube
support / Soporte de tubo con
sujeción a pared.



MATERIAL: EN 1.4301 / AISI 304

ACABAMENTO / FINISH / ACABADO:
STANDARD: SATINADO / SATIN / SATIN

OPTIONAL: PVD TITANIUM COATED

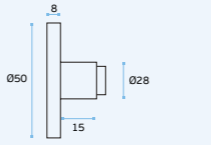

SM.010.A.25.3000

Tubo Ø25 com 3000mm /
Tube Ø25 with 3000mm /
Tubo Ø25 con 3000mm.



MATERIAL: EN 1.4301 / AISI 304

ACABAMENTO / FINISH / ACABADO:
SATINADO / SATIN / SATIN



SM.010.C

Conector para tubo /
Tube connector /
Conector de tubo.



MATERIAL: EN 1.4301 / AISI 304

ACABAMENTO / FINISH / ACABADO:
SATINADO / SATIN / SATIN

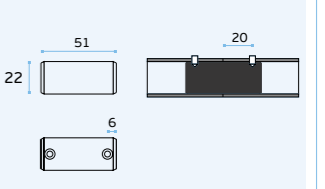

SM.032

União de tubo a 90° para tubo
Ø25mm / Tube connector at 90°
for Ø25mm tube / Unión de tubo a
90° para tubo Ø25mm.



MATERIAL: EN 1.4301 / AISI 304

ACABAMENTO / FINISH / ACABADO:
STANDARD: SATINADO / SATIN / SATIN

OPTIONAL: PVD TITANIUM COATED

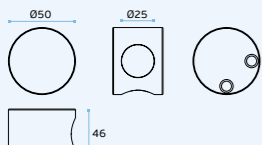

SM.033

União de tubo a 90° e 180° para
tubo Ø25mm / Tube connector at 90°
and 180° for Ø25mm tube / Unión de
tubo a 90° y 180° para tubo Ø25mm.



MATERIAL: EN 1.4301 / AISI 304

ACABAMENTO / FINISH / ACABADO:
STANDARD: SATINADO / SATIN / SATIN

OPTIONAL: PVD TITANIUM COATED

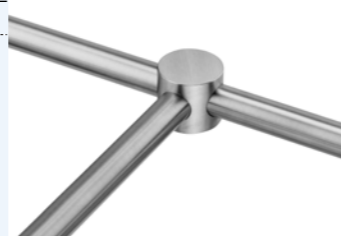
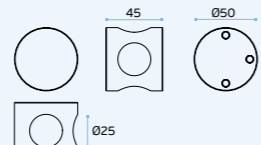

SM.102

Perfil em "U" para painel
ou vidro de 10mm /
"U" shape profile for 10mm
panel or glass /
Perfil en "U" para panel o
cristal de 10mm.

MATERIAL: EN 1.4301 / AISI 304

ACABAMENTO / FINISH / ACABADO:
SATINADO / SATIN / SATIN

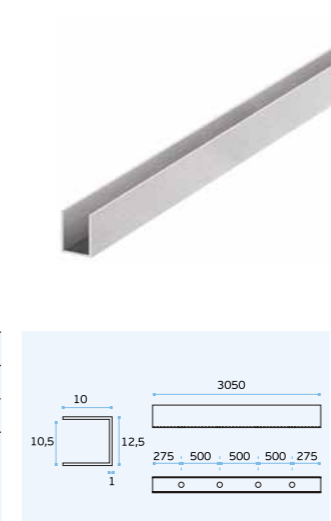

SM.101

Perfil em "U" para painel
ou vidro de 10mm /
"U" shape profile for 10mm
panel or glass /
Perfil en "U" para panel o
cristal de 10mm.

MATERIAL: EN 1.4301 / AISI 304

ACABAMENTO / FINISH / ACABADO:
SATINADO / SATIN / SATIN

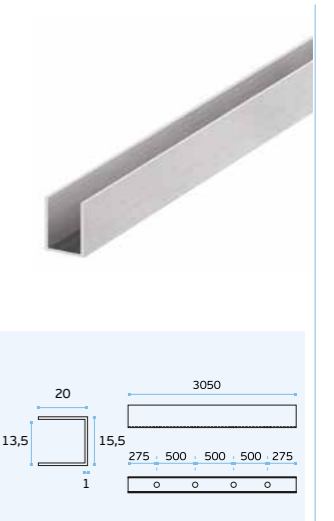

FECHOS PARA PORTAS DE VIDRO /
BOLTS FOR GLASS DOORS /
CIERRES PARA PUERTAS DE CRISTAL /



IN.17.501

Fecho com indicador de cor para cabines em vidro. Testa para vidro incluida / Latch with colour indication for glass doors. Strike box for glass included / Cierre con indicacion de color cabinas en cristal. Caja cerradero para cristal incluida.

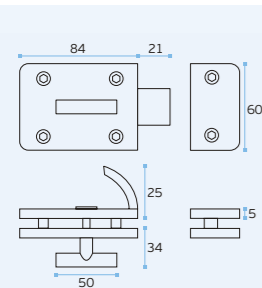

MATERIAL: EN 1.4301 / AISI 304

ACABAMENTO / FINISH / ACABADO: STANDARD: SATINADO / SATIN / SATIN



IN.17.502

Fecho sem indicador de cor para cabines em vidro. Testa para vidro incluida / Latch without colour indication for glass doors. Strike box for glass included / Cierre sin indicacion de color cabinas en cristal. Caja cerradero para cristal incluida.

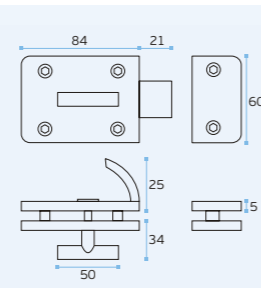

MATERIAL: EN 1.4301 / AISI 304

ACABAMENTO / FINISH / ACABADO: STANDARD: SATINADO / SATIN / SATIN



IN.17.504
Testa para aplicar no aro / Strike plate to install in the door frame / Cerradero para aplicar en el marco de la puerta.

LATCH WITH HANDLE FOR GLASS DOORS

FECHO COM PUXADOR PARA PORTAS DE VIDRO / CIERRE CON TIRADOR PARA PUERTAS DE CRISTAL

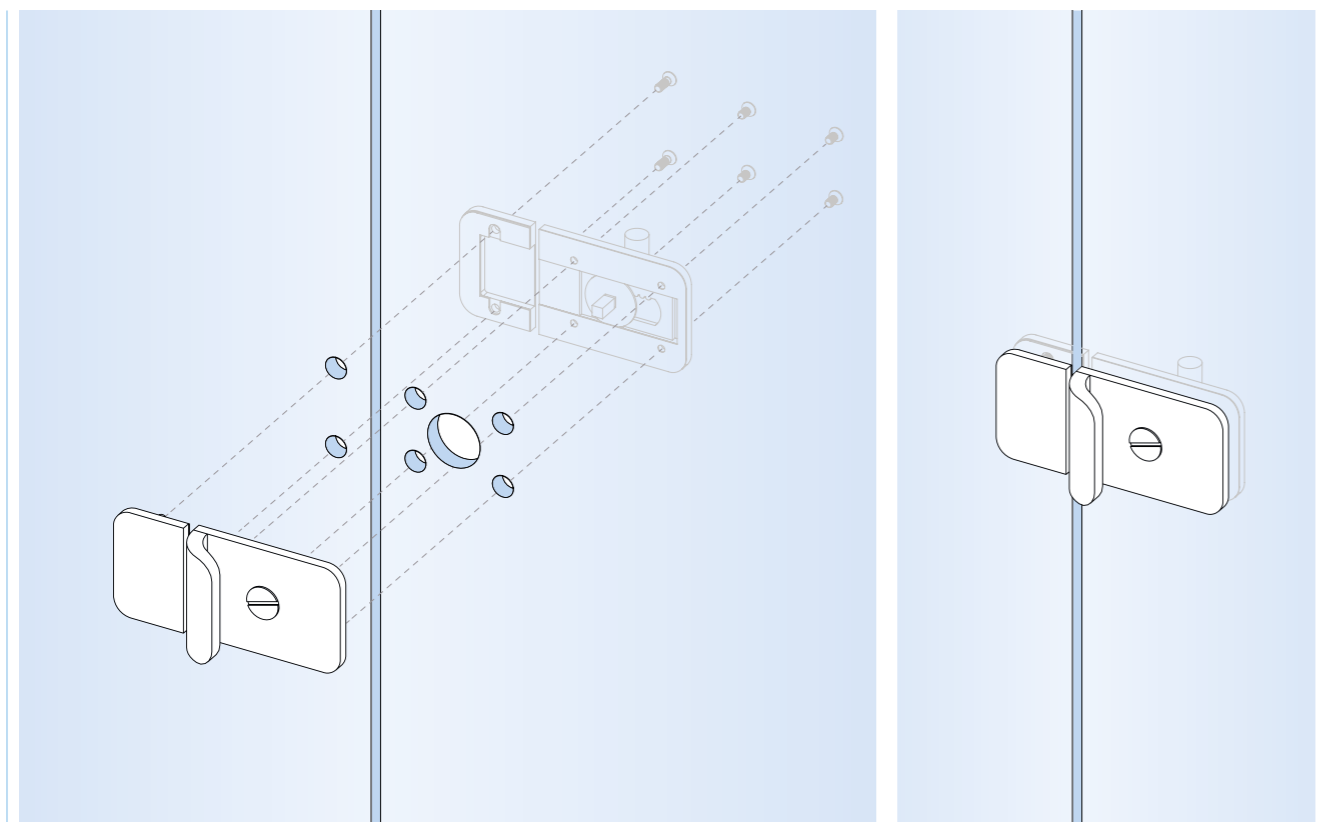

FECHOS PARA PORTAS DE VIDRO / BOLTS FOR GLASS DOORS / CIERRES PARA PUERTAS DE CRISTAL /

SM.028

Fecho com indicador de cor para cabines em vidro /
Latch with colour indication for glass doors /
Cierre con indicacion de color cabinas en cristal.



MATERIAL: EN 1.4301 / AISI 304
ACABAMENTO / FINISH / ACABADO:
STANDARD: SATINADO / SATIN / SATIN

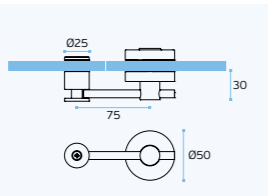

SM.028.B

Fecho com indicador para cabines em vidro /
Latch with colour indication for glass doors /
Cierre con indicacion de color cabinas en cristal.



MATERIAL: EN 1.4301 / AISI 304
ACABAMENTO / FINISH / ACABADO:
STANDARD: SATINADO / SATIN / SATIN

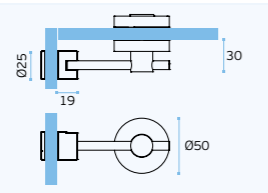

SM.028.C

Fecho com indicador para portas de correr em vidro /
Latch with colour indication for sliding glass doors /
Cierre para puertas correderas en cristal.



MATERIAL: EN 1.4301 / AISI 304
ACABAMENTO / FINISH / ACABADO:
STANDARD: SATINADO / SATIN / SATIN

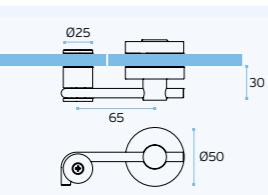

TWO IN ONE

FECHO E PUXADOR /
LATCH AND KNOB /
CIERRE Y POMO.

PUXADOR E
DESBLOQUEIO DE
EMERGÊNCIA /
KNOB AND
EMERGENCY LATCH /
POMO Y DESBLOQUEO
DE EMERGENCIA.



SM.060.V

Fecho com indicador para portas de correr em vidro /
Latch with colour indication for sliding glass doors /
Cierre para puertas correderas en cristal.

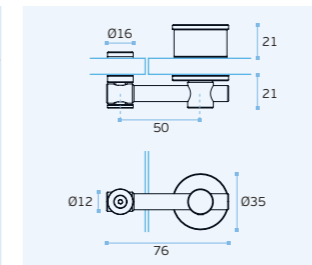
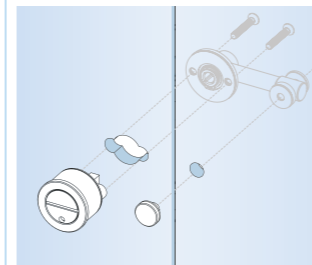

MATERIAL: EN 1.4301 / AISI 304
ACABAMENTO / FINISH / ACABADO: SATINADO / SATIN / SATIN
OPTIONAL: PVD TITANIUM COATED



SM.060.V.TB
pvd titanium BLACK



SM.060.V.TG
pvd titanium GOLD



SM.060.V.TCO
pvd titanium COPPER



SM.060.V.TCH
pvd titanium CHOCOLATE

SOLUÇÕES DE FERRAGENS PARA CABINES DE VIDRO / GLASS HARDWARE SOLUTIONS FOR CABINS / SOLUCIONES DE HERRAJES PARA CABINAS DE CRISTAL



IN.80.404
IN.80.454

Suporte vidro - vidro /
Glass - glass connector /
Soporte cristal - cristal.



MATERIAL: EN 1.4401 / AISI 316

ACABAMENTO / FINISH / ACABADO
STANDARD: SATINADO / SATIN / SATIN

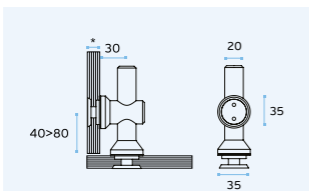
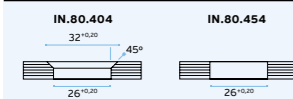

IN.80.405
IN.80.455

Suporte vidro - vidro /
Glass - glass connector /
Soporte cristal - cristal.



MATERIAL: EN 1.4401 / AISI 316

ACABAMENTO / FINISH / ACABADO
STANDARD: SATINADO / SATIN / SATIN

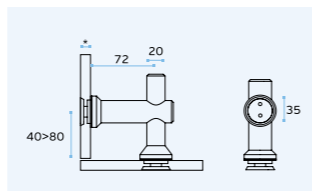
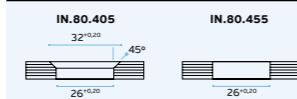

IN.80.406
IN.80.456

Suporte pavimento ou tecto - vidro /
Ground or ceiling - glass connector /
Soporte suelo o techo - cristal.



MATERIAL: EN 1.4401 / AISI 316

ACABAMENTO / FINISH / ACABADO
STANDARD: SATINADO / SATIN / SATIN

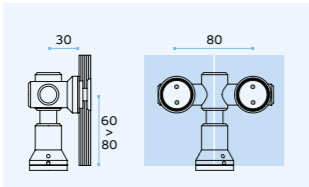
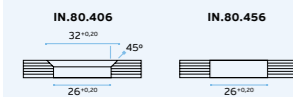

IN.80.407
IN.80.457

Suporte pavimento ou tecto - vidro /
Ground or ceiling - glass connector /
Soporte suelo o techo - cristal.



MATERIAL: EN 1.4401 / AISI 316

ACABAMENTO / FINISH / ACABADO
STANDARD: SATINADO / SATIN / SATIN

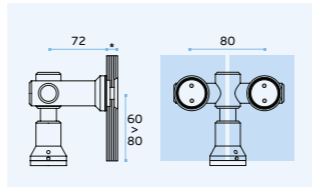
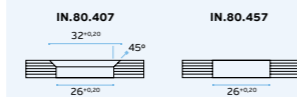

IN.80.460

Suporte de vidro ajustável /
Adjustable glass support /
Soporte cristal ajustable.



MATERIAL: EN 1.4401 / AISI 316

ACABAMENTO / FINISH / ACABADO
STANDARD: SATINADO / SATIN / SATIN

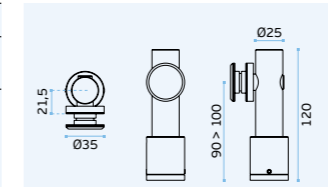
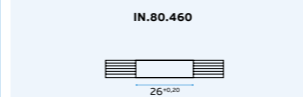

IN.80.401
IN.80.451

Suporte pavimento ou tecto - vidro /
Ground or ceiling - glass connector /
Soporte suelo o techo - cristal.



MATERIAL: EN 1.4401 / AISI 316

ACABAMENTO / FINISH / ACABADO
STANDARD: SATINADO / SATIN / SATIN

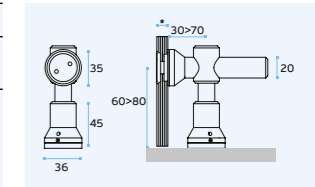
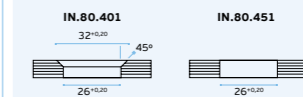

IN.80.408
IN.80.458

Suporte vidro - vidro /
Glass - glass connector /
Soporte cristal - cristal.



MATERIAL: EN 1.4401 / AISI 316

ACABAMENTO / FINISH / ACABADO
STANDARD: SATINADO / SATIN / SATIN

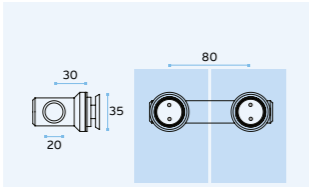
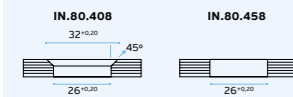

IN.80.409
IN.80.459

Suporte vidro - vidro /
Glass - glass connector /
Soporte cristal - cristal.



MATERIAL: EN 1.4401 / AISI 316

ACABAMENTO / FINISH / ACABADO
STANDARD: SATINADO / SATIN / SATIN

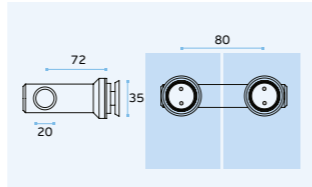
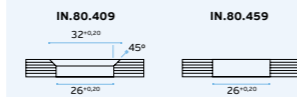

IN.80.402
IN.80.452

Suporte pavimento ou tecto - vidro /
Ground or ceiling - glass connector /
Soporte suelo o techo - cristal.



MATERIAL: EN 1.4401 / AISI 316

ACABAMENTO / FINISH / ACABADO
STANDARD: SATINADO / SATIN / SATIN

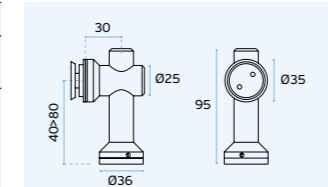
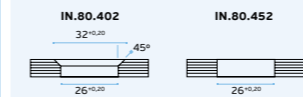

IN.80.403
IN.80.453

Suporte pavimento ou tecto - vidro /
Ground or ceiling - glass connector /
Soporte suelo o techo - cristal.



MATERIAL: EN 1.4401 / AISI 316

ACABAMENTO / FINISH / ACABADO
STANDARD: SATINADO / SATIN / SATIN

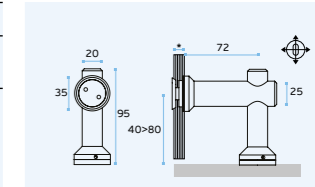
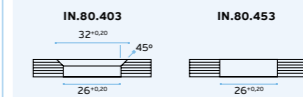

VEDANTES PARA VIDRO (8-12MM) / PVC SEALS FOR GLASS (8-12MM) / SELLOS PARA CRISTAL (8-12MM).

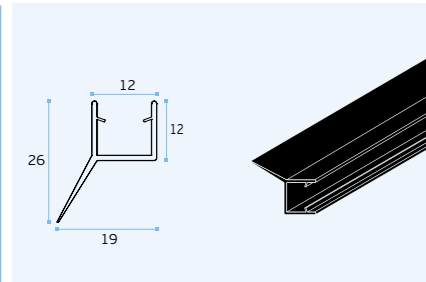

IN.15.998.A (2000mm)
Vedante para vidro /
PVC seals for glass /
Sellos para cristal.

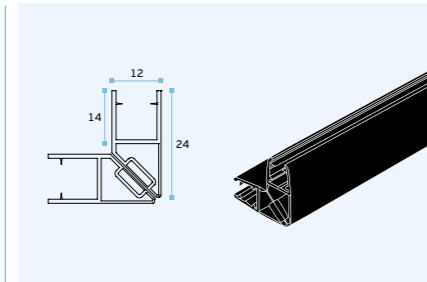

IN.15.998.B (2000mm)
IN.15.998.B.L (2500mm)
Vedante magnético para vidro 90° /
90° Magnetic PVC seals for glass /
Sello magnetico para cristal 90°

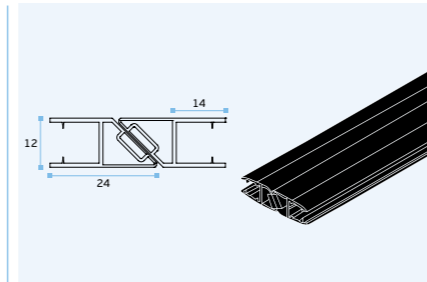

IN.15.998.C (2000mm)
IN.15.998.C.L (2500mm)
Vedante magnético para vidro 180° /
180° Magnetic PVC seals for glass /
Sello magnetico para cristal 180°

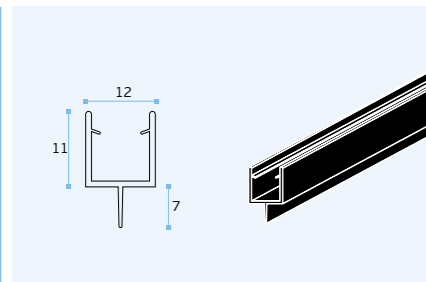

IN.15.998.D (2000mm)
Vedante para vidro /
PVC seals for glass /
Sellos para cristal

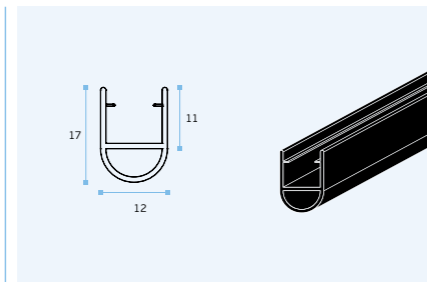

IN.15.998.E (2000mm)
IN.15.998.E.L (2500mm)
Vedante para vidro /
PVC seals for glass /
Sellos para cristal

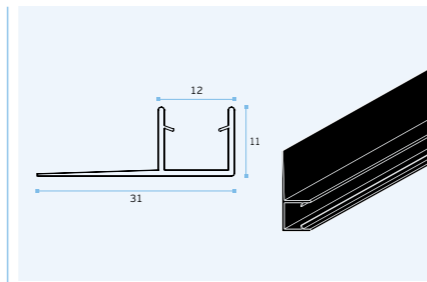

IN.15.998.F (2000mm)
IN.15.998.F.L (2500mm)
Vedante para vidro /
PVC seals for glass /
Sellos para cristal

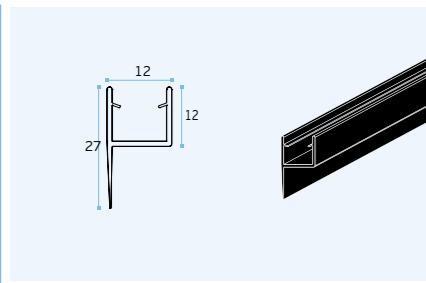

IN.15.998.G (2000mm)
Vedante para vidro /
PVC seals for glass /
Sellos para cristal.

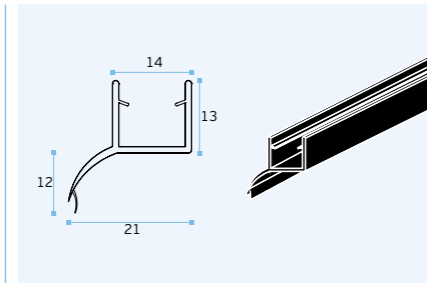

IN.15.998.H (2000mm)
Vedante para vidro /
PVC seals for glass /
Sellos para cristal

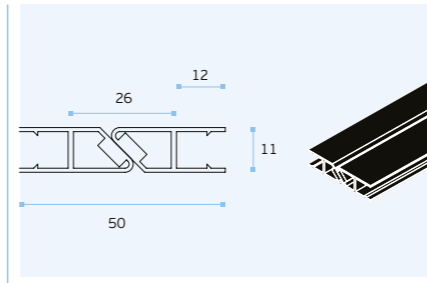

IN.15.996.C (2000mm)
IN.15.996.C.L (2500mm)
Vedante magnético para vidro /
Magnetic PVC seals for glass /
Sello magnetico para cristal

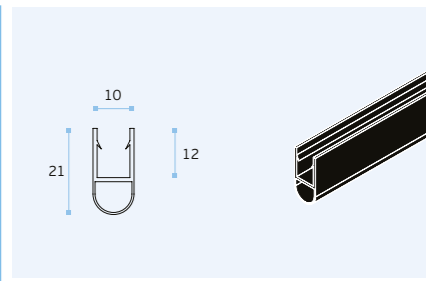

IN.15.996.E (2000mm)
IN.15.996.E.L (2500mm)
Vedante para vidro /
PVC seals for glass /
Sellos para cristal

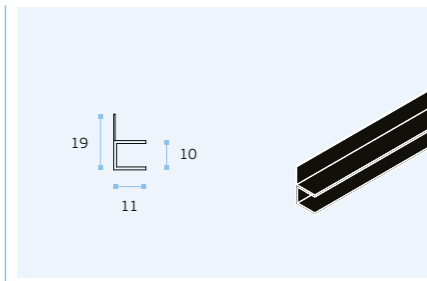

IN.15.996.F (2000mm)
IN.15.996.F.L (2500mm)
Vedante para vidro /
PVC seals for glass /
Sellos para cristal

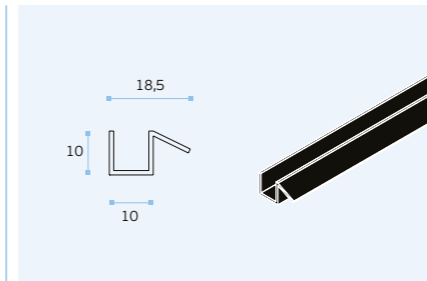

IN.15.996.J (2000mm)
Vedante para vidro /
PVC seals for glass /
Sellos para cristal



BLACK PVC SEALS



Perfis desenvolvidos para a indústria do vidro, principalmente para cabines de duche. Portas de vidro de correr, batente e de fole, dependendo do tipo de aplicação, estes vedantes são produzidos com PVC rígido ou misto rígido e flexível.

O PVC utilizado é resistente aos raios UV evitando a mudança de cor com o passar do tempo.

As soluções magnéticas ajudam a manter as portas fechadas e a controlar as saídas de água.

Profiles developed for the glass industry, mainly for shower cabins. Sliding, rebated and folding glass doors, depending on the type of application, these seals are produced with rigid or mixed rigid and flexible PVC.

The PVC used is resistant to UV rays, preventing color change over time.

The magnetic solutions help keep doors closed and control water leaks.

Perfiles desarrollados para la industria del cristal, principalmente para cabinas de ducha. Puertas de cristal corredizas, solapadas y plegables, dependiendo del tipo de aplicación, estos sellas se fabrican con PVC rígido o mixto rígido y flexible.

El PVC utilizado es resistente a los rayos UV evitando que cambie de color con el paso del tiempo.

Las soluciones magnéticas ayudan a mantener las puertas cerradas y controlan las fugas de agua.

VEDANTES PARA VIDRO (8-12MM) / PVC SEALS FOR GLASS (8-12MM) / SELLOS PARA CRISTAL (8-12MM).

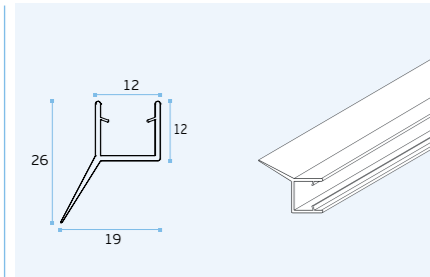

IN.15.999.A (2000mm)
Vedante para vidro /
PVC seals for glass /
Sellos para cristal.

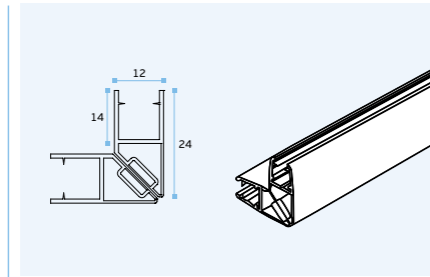

IN.15.999.B (2000mm)
IN.15.999.B.L (2500mm)
Vedante magnético para vidro 90° /
90° Magnetic PVC seals for glass /
Sello magnetico para cristal 90°

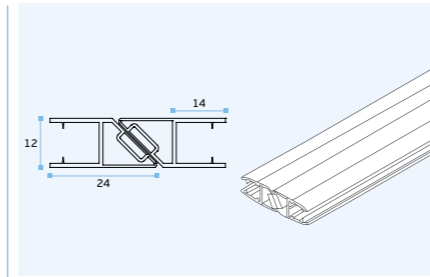

IN.15.999.C (2000mm)
IN.15.999.C.L (2500mm)
Vedante magnético para vidro 180° /
180° Magnetic PVC seals for glass /
Sello magnetico para cristal 180°

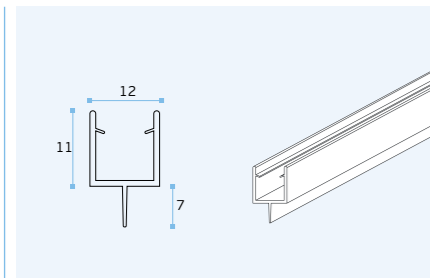

IN.15.999.D (2000mm)
Vedante para vidro /
PVC seals for glass /
Sellos para cristal

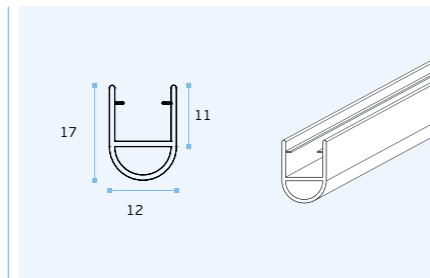

IN.15.999.E (2000mm)
IN.15.999.E.L (2500mm)
Vedante para vidro /
PVC seals for glass /
Sellos para cristal

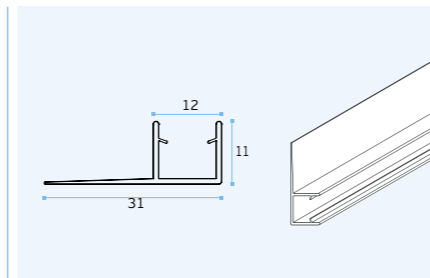

IN.15.999.F (2000mm)
IN.15.999.F.L (2500mm)
Vedante para vidro /
PVC seals for glass /
Sellos para cristal

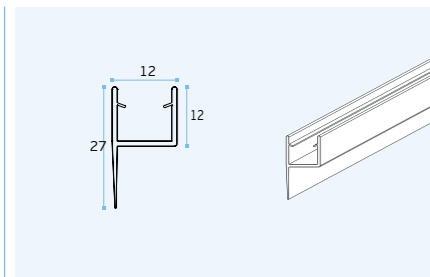

IN.15.999.G (2000mm)
Vedante para vidro /
PVC seals for glass /
Sellos para cristal.

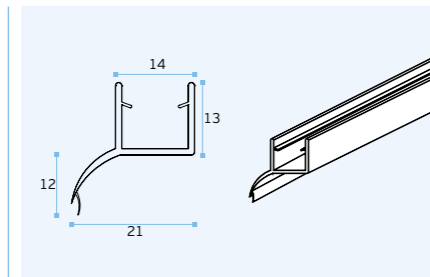

IN.15.999.H (2000mm)
Vedante para vidro /
PVC seals for glass /
Sellos para cristal

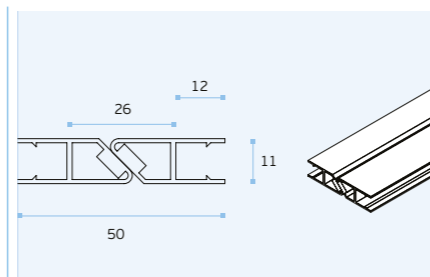

IN.15.997.C (2000mm)
IN.15.997.C.L (2500mm)
Vedante magnético para vidro /
Magnetic PVC seals for glass /
Sello magnetico para cristal

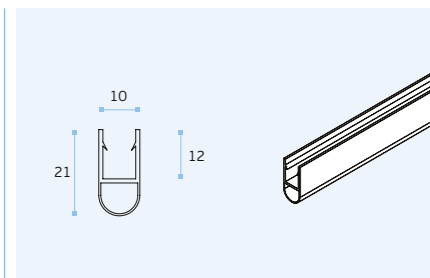

IN.15.997.E (2000mm)
IN.15.997.E.L (2500mm)
Vedante para vidro /
PVC seals for glass /
Sellos para cristal

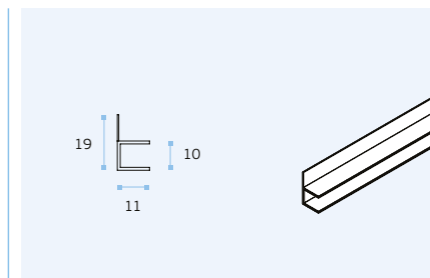

IN.15.997.F (2000mm)
IN.15.997.F.L (2500mm)
Vedante para vidro /
PVC seals for glass /
Sellos para cristal

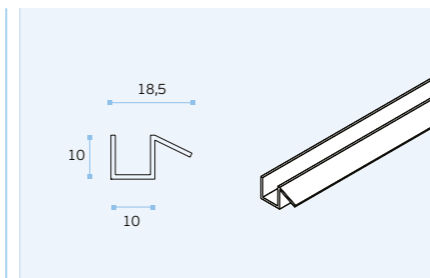

IN.15.997.J (2000mm)
Vedante para vidro /
PVC seals for glass /
Sellos para cristal



TRANSPARENT PVC SEALS

Perfis desenvolvidos para a indústria do vidro, principalmente para cabines de duche. Portas de vidro de correr, batente e de fole, dependendo do tipo de aplicação, estes vedantes são produzidos com PVC rígido ou misto rígido e flexível.

O PVC utilizado é resistente aos raios UV evitando a mudança de cor com o passar do tempo.

As soluções magnéticas ajudam a manter as portas fechadas e a controlar as saídas de água.

Profiles developed for the glass industry, mainly for shower cabins. Sliding, rebated and folding glass doors, depending on the type of application, these seals are produced with rigid or mixed rigid and flexible PVC.

The PVC used is resistant to UV rays, preventing color change over time.

The magnetic solutions help keep doors closed and control water leaks.

Perfiles desarrollados para la industria del cristal, principalmente para cabinas de ducha. Puertas de cristal corredizas, solapadas y plegables, dependiendo del tipo de aplicación, estos sellas se fabrican con PVC rígido o mixto rígido y flexible.

El PVC utilizado es resistente a los rayos UV evitando que cambie de color con el paso del tiempo.

Las soluciones magnéticas ayudan a mantener las puertas cerradas y controlan las fugas de agua.

FECHADURAS PARA PORTAS DE VIDRO / LOCKS FOR GLASS DOORS / CERRADURAS PARA PUERTAS DE CRISTAL.



ALL IN GLASS LOCK

Fechadura ALL IN para portas de vidro. Corpo interior multifuncional, para funções de cilindro, passagem e casa de banho.

Reversível com várias afinações, ajuste da força da mola, compensação do ângulo do puxador. Sistema de instalação fácil do cilindro. Possível instalar com qualquer modelo de puxador JNF.

Tampas de aço inoxidável com diferentes acabamentos, satinado, polido e pvd titânio preto, dourado, cobre e chocolate.

ALL IN lock for glass doors with square shape multifunctional body, cylinder, passage, bathroom types.

Reversible and easy adjustments, as cylinder installation, handle power and angle. Possible to instal with any JNF lever handle.

Stainless steel covers in different finishes, satin, polished and pvd titanium black, gold, copper and chocolate.

Cerradura ALL IN para puertas de cristal. Cuerpo interior multifuncional, para funciones de cilindro, paso y baño.

Reversible y con varios ajustes, como regulación de la fuerza del muelle de la manilla y compensación del ángulo de la manilla y sistema de fácil instalación del cilindro.

Posible instalar con cualquier modelo de manilla JNF.

Tapas de acero inoxidable con distintos acabados, satinado, pulido y pvd negro titanio, dorado, cobre y chocolate.



FECHADURAS PARA PORTAS DE VIDRO / LOCKS FOR GLASS DOORS / CERRADURAS PARA PUERTAS DE CRISTAL.

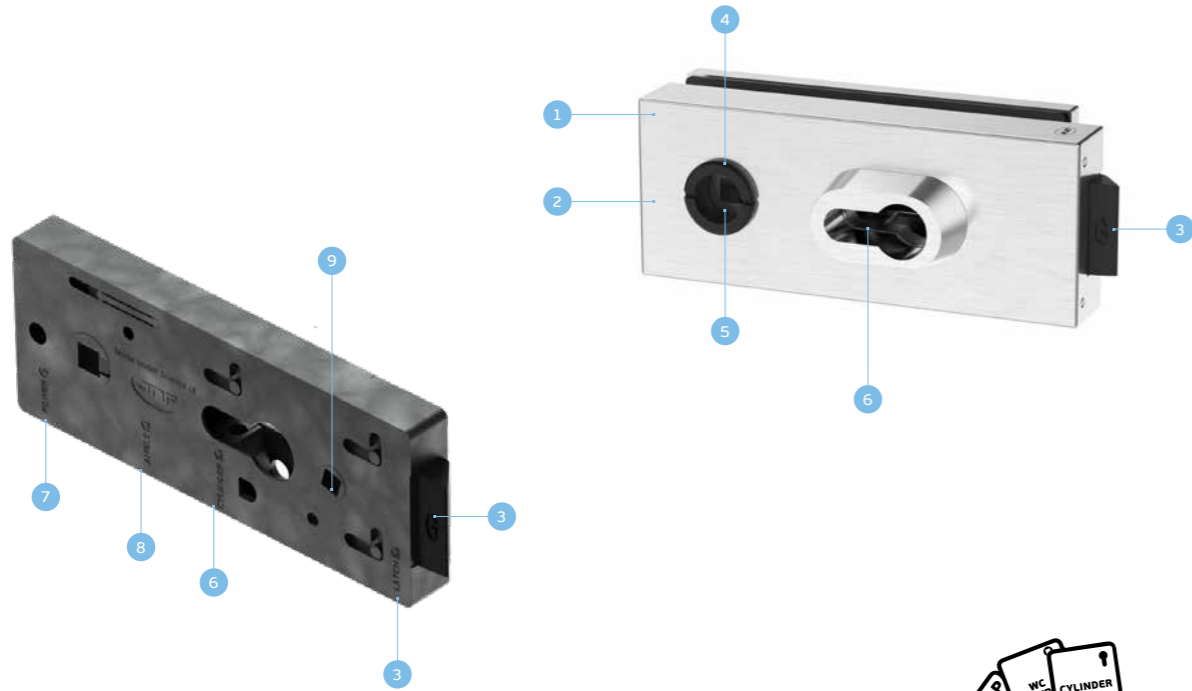

ALL IN GLASS LOCK

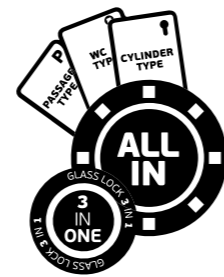

1. Fechadura ALL IN reversível multifunções para vidro / Reversible multi function glass lock / Cerradura reversible multifunciones para cristal.

2. Tampas em aço inoxidável EN 1.4301-AISI 304 acabamentos: satinado, polido ou PVD TITANIUM (preto, dourado, cobre e chocolate) / Covers in stainless steel EN 1.4301-AISI 304 with: satin, polished or PVD TITANIUM finishes (black, gold, copper and chocolate) / Tapas en acero inoxidable EN 1.4301-AISI 304 con acabados: satinado, pulido y PVD TITANIUM (negro, dorado, cobre y chocolate).

3. O trinco de nylon + fibra de vidro torna-o robusta e silenciosa. Reversível apenas removendo um parafuso / The nylon + fiberglass latch makes it robust and silent. Reversible just by removing a screw / Picaporte de nylon + fibra de vidro lo hace fuerte y silencioso. Reversible solo quitando un tornillo.

4. Possível instalar com qualquer modelo de puxador JNF (puxador não incluído) / Can be installed with any JNF handle (lever handle not included) / Se puede instalar con cualquier modelo de manilla JNF (manilla no incluído).

5. Quadra com mola interior para eliminação da folga entre o puxador e a fechadura. Em aço inox EN 1.4301-AISI 304 / Handle square hole with a internal spring to avoid any break between the spindle and the lock. Made in stainless steel EN 1.4301-AISI 304 / Nueca en acero inox con muelle interior para eliminar la holgura entre la manilla y a cerradura. En acero inox EN 1.4301-AISI 304.

6. Sistema de fácil fixação de cilindro, a fechadura possui um sistema de fixação especial para evitar danos causados com o parafuso do cilindro. Pode ser instalado qualquer cilindro de perfil europeu, recomendado 30x30 (cilindro não incluído) / Easy cylinder fixing system, the lock has a special fixing system to avoid damage caused by the cylinder screw. Any European profile cylinder can be installed, recommended 30x30 (cylinder not included) / Sistema fácil de fijación del cilindro, la cerradura tiene un sistema de fijación especial para evitar daños causados por el tornillo del cilindro. Se puede instalar cualquier cilindro de perfil europeo, recomendado 30x30 (cilindro no incluído).

7. Ajuste do ângulo do puxador, permite fazer compensação conforme o puxador se é mais ou menos pesado / Handle angle adjustment, allows you to compensate for a heavier or less heavy handle / Ajuste del ángulo de la manilla, permite compensar un manilla más o menos pesado.

8. Ajuste da força da mola de recuperação do puxador / Handle recovery spring force adjustment / Ajuste de la fuerza del resorte de recuperación de la manilla.

9. Função de fecho de casa de banho, aplicável com um dos 10 modelos de botão JNF / Bathroom lock function, applicable with one of 10 JNF button models / Función de bloqueo de baño, aplicable con uno de los 10 modelos de botones JNF.

10. Anilha para fixação do puxador e tampa. Fornecida com uma chave especial para instalação / Washer for handle and cover fixing. Supplied with special key for tightening / Arandela para fijación de manilla y tapa. Se suministra con llave especial para instalación.

11. Proteção de cilindro maciça, garante a proteção do cilindro contra torção / Solid cylinder protection, ensures the protection of the cylinder against torsion / Protección de cilindro macizo asegura la protección del cilindro contra torsión.

12. Corpo reversível em liga metálica. Mesmo corpo 3 funções diferentes, Cilindro, passagem e WC / Reversible body made in metallic alloy. Same body 3 different functions, Cylinder, passage and bathroom type / Cuerpo reversible fabricado en aleación metálica. Mismo cuerpo 3 funciones diferentes, Cilindro, paso y tipo baño.

13. Junta especial para evitar riscar o vidro e o movimento da fechadura / Special gasket to avoid scratching the glass and the movement of the lock / Junta especial para evitar rayar el cristal y el movimiento de la cerradura.

14. Entalhe simples no vidro, compatível com as três versões, para vidro de 8 a 12mm de espessura ou painel fenólico de 10 ou 13mm / Simple cut out on the glass, compatible with three versions, for glass from 8 to 12mm thickness or phenolic panel 10 or 13mm / Recorte simple en el cristal, compatible con tres versiones, para cristal de 8 a 12mm de espesor o panel fenólico de 10 o 13mm.

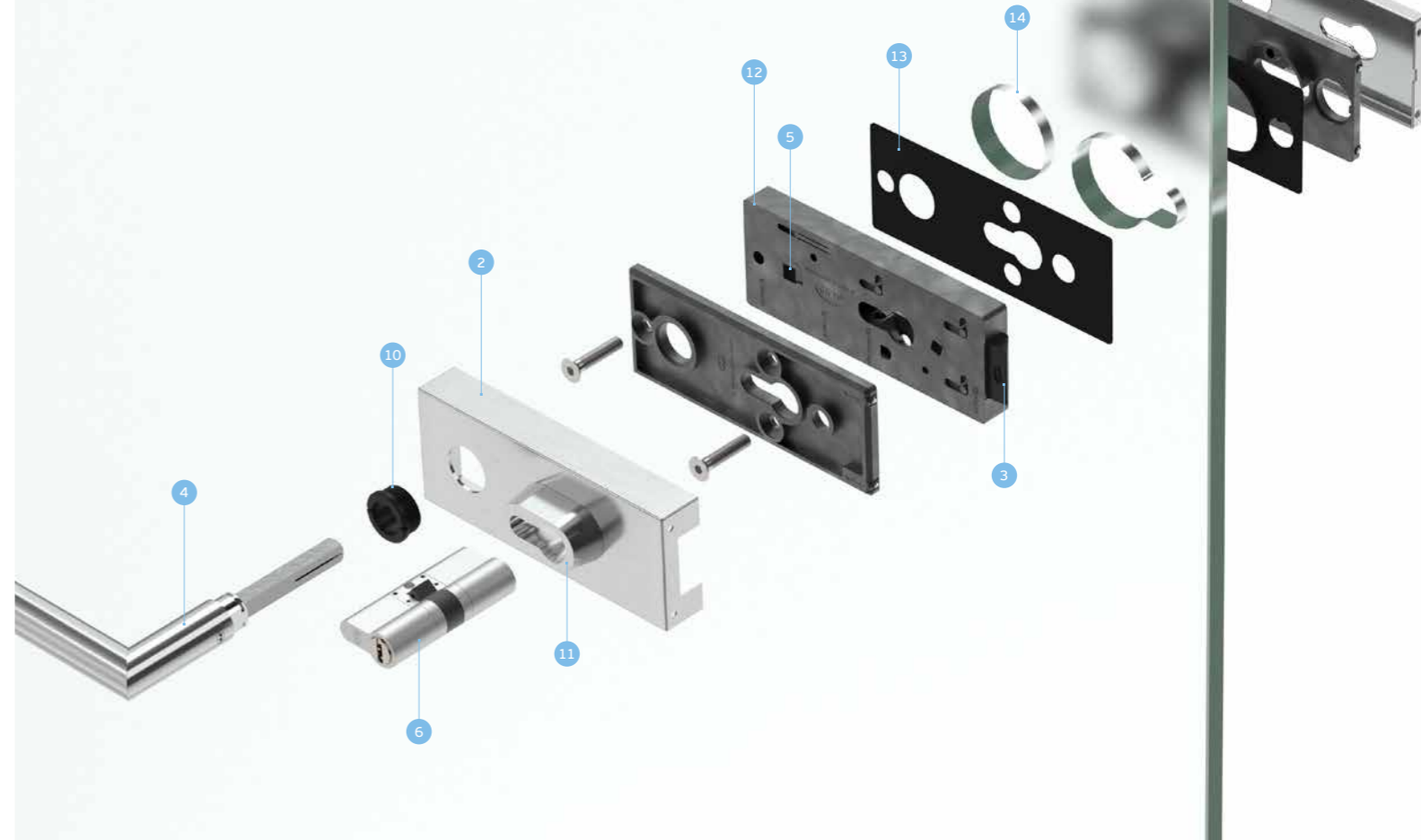

COMO CONFIGURAR FECHADURA DE VIDRO JNF:

HOW TO CONFIGURE JNF GLASS LOCK:

CÓMO CONFIGURAR LA CERRADURA DE CRISTAL JNF:

1º

1º Escolher o modelo de fechadura

1º Choose the lock model

1º Elige el modelo de cerradura



IN.20.360



IN.20.361



IN.20.362



IN.20.363



IN.20.364

2º

2º Escolher o modelo de puxador com roseta

2º Choose the model of handle with rose

2º Elige el modelo de manilla con roseta



IN.00.030.SR



IN.00.028.SR



IN.00.028.B.SR



IN.00.060.SR



IN.00.311.SR



IN.00.141.SR

3º

3º Escolher o modelo de cilindro, se aplicável.

3º Choose the model of cylinder, if applicable.

3º Elige el modelo de cilindro, si corresponde.



IN.19.590.35.35



IN.19.540.30.30



IN.19.530.30.30



IN.19.522.30.30



IN.19.511.30.30



IN.19.501.30.30

Aplicável sem outros modelos de puxadores JNF / Applicable without other JNF lever handle models / Aplicable sin otros modelos de manillas JNF.

FECHADURAS PARA PORTAS DE VIDRO / LOCKS FOR GLASS DOORS / CERRADURAS PARA PUERTAS DE CRISTAL.



ACABAMENTOS ESPECIAIS EM AÇO INOX REVESTIDO A PVD TITÂNIO

Este acabamento é conseguido pela tecnologia PVD (Physical Vapor Deposition). É um processo não galvânico, não poluente, amplamente utilizado na indústria da relojoaria.

Trata-se dum acabamento de excepcional qualidade, conferindo ao produto final uma dureza adicional e uma resistência à corrosão elevadíssima.

SPECIAL FINISH ON STAINLESS STEEL TITANIUM PVD COATED

This finish is achieved by PVD technology (Physical Vapor Deposition). It is a non galvanic, pollution free process, widely used in the watchmaking industry.

This is an exceptionally high quality finish, giving the final product an additional hardness and a very high corrosion resistance.

ACABADOS ESPECIALES EN ACERO INOXIDABLE EN TITANIO PVD

Este acabado se consigue mediante la tecnología PVD (Physical Vapor Deposition). Es un proceso no galvánico, no contaminante, muy utilizado en la industria relojera.

Se trata de un acabado de excepcional calidad, que aporta al producto final una dureza adicional y una altísima resistencia a la corrosión.

.TB. PVD TITANIUM BLACK .TCO PVD TITANIUM COPPER .P POLISHED
.TG PVD TITANIUM GOLD .TCH PVD TITANIUM NATURAL .S SATIN

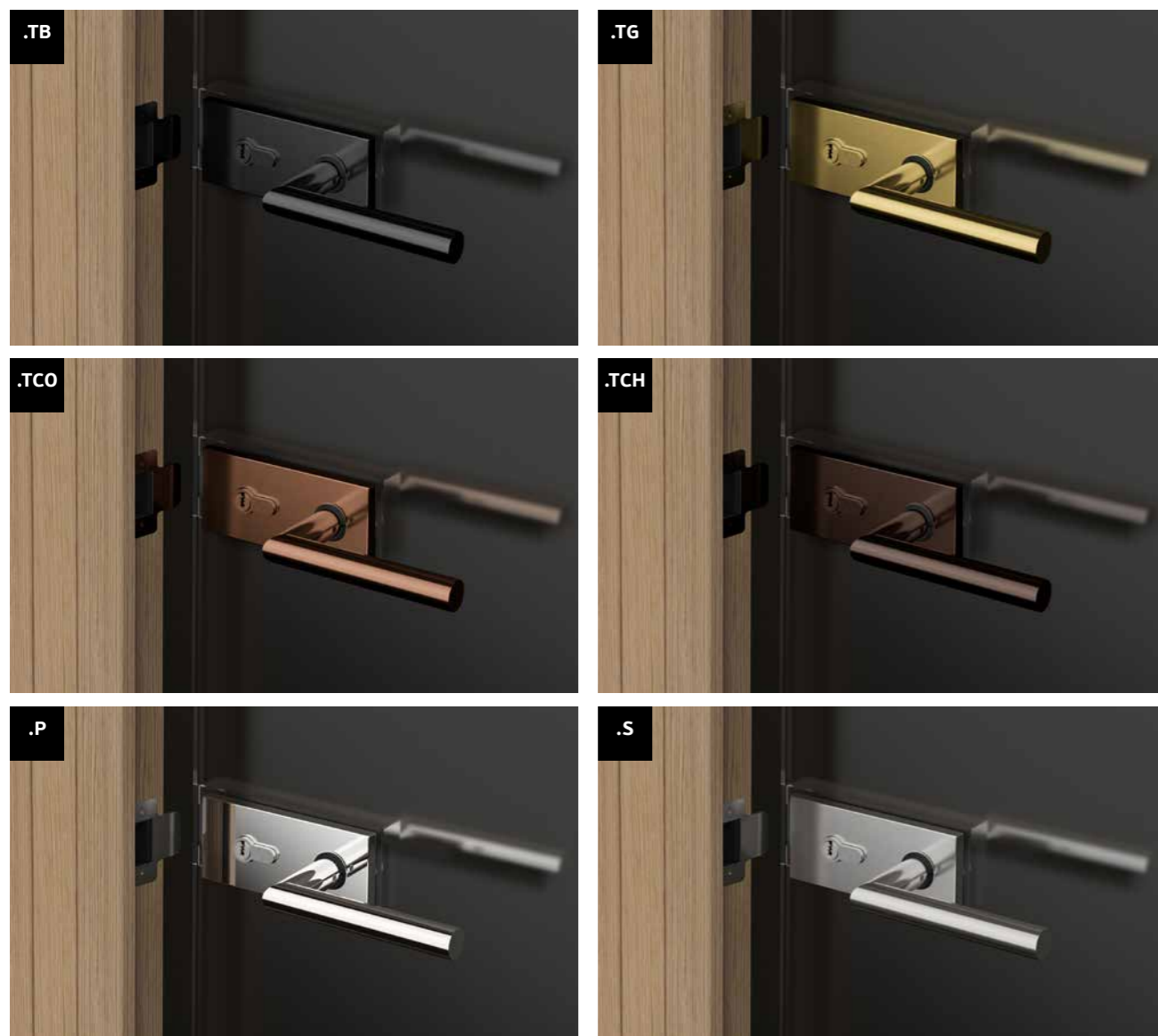

PVD TITANIUM

Num planeta constantemente exposto a agressões ambientais, na JNF trabalhamos diariamente no sentido de diminuir a "pegada ecológica" dos nossos processos e produtos. Para além da utilização do aço inoxidável, também utilizamos acabamentos especiais não galvânicos e não poluentes, como é o caso do acabamento em titânio e do acabamento MICROsafe™ conseguido através da tecnologia PVD (Physical Vapor Deposition). Disponível com acabamentos PVD TITANIUM em preto, dourado, chocolate, cobre e MICROsafe™ /

On a planet constantly exposed to environmental aggressions, at JNF we work daily to reduce the "ecological footprint" of our processes and products. In addition to the use of stainless steel, we also use special non-galvanic and non-polluting finishes, such as the titanium and MICROsafe™ finish achieved through PVD (Physical Vapor Deposition) technology. Available in TITANIUM PVD finishes in black, gold, chocolate, copper and MICROsafe™ /

En un planeta constantemente expuesto a las agresiones ambientales, en JNF trabajamos diario para reducir la "huella ecológica" de nuestros procesos y productos. Además del uso de acero inoxidable, también utilizamos acabados especiales no galvânicos y no contaminantes, como el acabado de titanio e MICROsafe™ logrado a través de la tecnología PVD (Physical Vapor Deposition). Disponible con acabados TITANIUM PVD en negro, dorado, chocolate, cobre y MICROsafe™.

FECHADURAS PARA PORTAS DE VIDRO / LOCKS FOR GLASS DOORS / CERRADURAS PARA PUERTAS DE CRISTAL.

IN.20.360

Fechadura para vidro com função cilindro europeu para puxador rotativo de ambos os lados (possível aplicar qualquer puxador JNF) / Cylinder type glass lock to use with rotative lever handles both sides (apply any JNF lever handle) / Cerradura para cristal con función cilindro europeo para usar con manillas rotativas en ambos lados. (aplicar cualquier manilla JNF)



MATERIAL: EN 1.4301 / AISI 304

FINISH: SATINADO / SATIN / SATIN

OPTIONAL: PVD TITANIUM



IMAGEM / IMAGE:
IN.20.360
IN.00.037.SR
IN.19.S22.30.30



IN.20.362

Fechadura para vidro com função de passagem para puxador rotativo de ambos os lados (possível aplicar qualquer puxador JNF) / Passage type glass lock to use with rotative lever handles both sides (apply any JNF lever handle) / Cerradura para cristal con función de paso para usar con manillas rotativas en ambos lados. (aplicar cualquier manilla JNF)

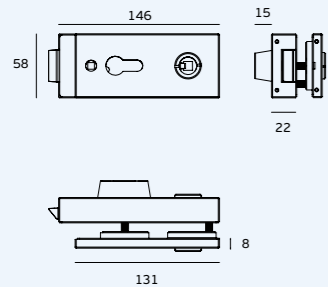

MATERIAL: EN 1.4301 / AISI 304

FINISH: SATINADO / SATIN / SATIN

OPTIONAL: PVD TITANIUM



IMAGEM / IMAGE:
IN.20.362
IN.00.037.SR



IN.20.363

Caixa testa reversível e ajustável para fechadura de portas de vidro / Reversible and adjustable strike box for glass lock / Caja Cerradero ajustable y reversible para puertas de cristal.

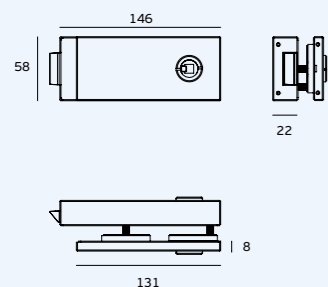

MATERIAL: EN 1.4301 / AISI 304

FINISH: SATINADO / SATIN / SATIN

OPTIONAL: PVD TITANIUM



IN.20.364

Testa ajustável e reversível para aplicar no aro da porta / Reversible and adjustable strike plate to apply in the door frame / Cerradero ajustable y reversible para aplicar en el marco de la puerta.



MATERIAL: EN 1.4301 / AISI 304

FINISH: SATINADO / SATIN / SATIN

OPTIONAL: PVD TITANIUM



IN.20.365

Acessório para puxador fixo do lado exterior / Accessory for fixed handle on the outer side / Accesorio para pomo fijo en el exterior

MATERIAL: EN 1.4301 / AISI 304

ACABAMENTO / FINISH / ACABADO:
STANDARD: SATINADO / SATIN / SATIN



IMAGEM / IMAGE:
IN.20.362
IN.00.037.SR
IN.00.092
IN.19.S40.____

FECHADURAS PARA PORTAS DE VIDRO / LOCKS FOR GLASS DOORS / CERRADURAS PARA PUERTAS DE CRISTAL.

IN.20.361

Fechadura para vidro com função WC com desbloqueio de emergência pelo exterior, para puxador rotativo de ambos os lados (possível aplicar qualquer puxador JNF) /

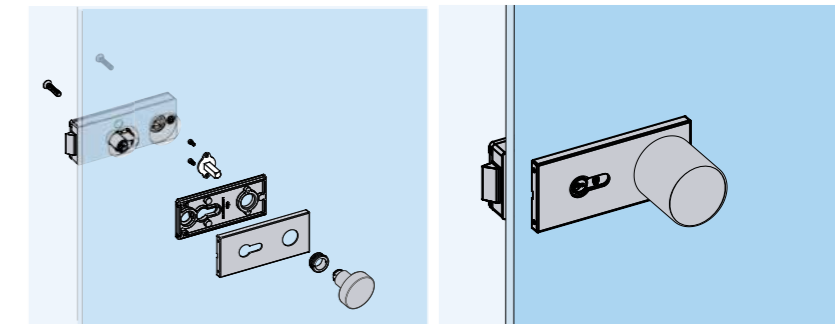
Bathroom type glass lock with emergency unlock from outside to use with rotative lever handles both sides (apply any JNF lever handle) /

Cerradura para cristal con función de baño con desbloqueo de emergencia por el exterior usar con manillas rotativas en ambos lados.

(aplicar cualquier manilla JNF)

.TB .TG .TCO .TCH

MATERIAL: EN 1.4301 / AISI 304

FINISH: SATINADO / SATIN / SATIN

OPTIONAL: PVD TITANIUM



IMAGEM / IMAGE:
IN.20.361
IN.00.037.SR
IN.19.B2

IN.20.366

Fechadura para vidro com função WC com indicação de cor e desbloqueio de emergência pelo exterior, para puxador rotativo de ambos os lados (possível aplicar qualquer puxador JNF) /

Bathroom type glass lock with color indicator and emergency unlock from outside to use with rotative lever handles both sides (apply any JNF lever handle) /

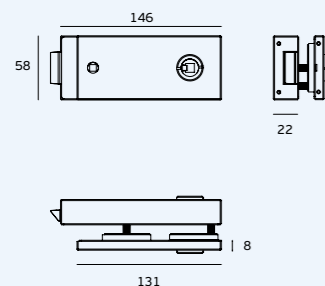
Cerradura para cristal con función de baño con indicador de color y desbloqueo de emergencia por el exterior usar con manillas rotativas en ambos lados.

(aplicar cualquier manilla JNF)

.TB .TG .TCO .TCH

MATERIAL: EN 1.4301 / AISI 304

FINISH: SATINADO / SATIN / SATIN

OPTIONAL: PVD TITANIUM



IMAGEM / IMAGE:
IN.20.366
IN.00.037.SR
IN.19.B2

IMAGEM / IMAGE:
IN.20.361.TCO
IN.20.364.TCO
IN.00.413.SR.TCO
IN.19.S22.30.30

FECHADURAS PARA PORTAS DE VIDRO / LOCKS FOR GLASS DOORS / CERRADURAS PARA PUERTAS DE CRISTAL.

Esta fechadura magnética foi desenvolvida para ser facilmente instalada em portas de vidro. O entalhe no vidro é standard e compatível entre fechaduras JNF. As fechaduras são reversíveis e muito versáteis, pois o puxador pode ser qualquer um do catálogo JNF assim como o cilindro, que pode ser escolhido de acordo com o nível de segurança requerido /

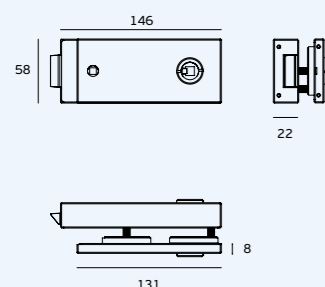
The magnetic lock was developed to be easy installed on glass doors. The cut out on the glass is standard and compatible between JNF locks. The locks are reversible and very versatil, as the lever handle can be any from JNF catalogue as well as the cylinder, that can be chosen accordingly to the required level of security /

Esta cerradura magnética fue desarrollada para ser instalada fácilmente en puertas de cristal. Lo mecanizado en el cristal es estándar y compatible entre cerraduras JNF. Las cerraduras son reversibles y muy versátiles, ya que la maneta puede ser cualquiera del catálogo JNF así como el cilindro, que se puede elegir según el nivel de seguridad requerido /

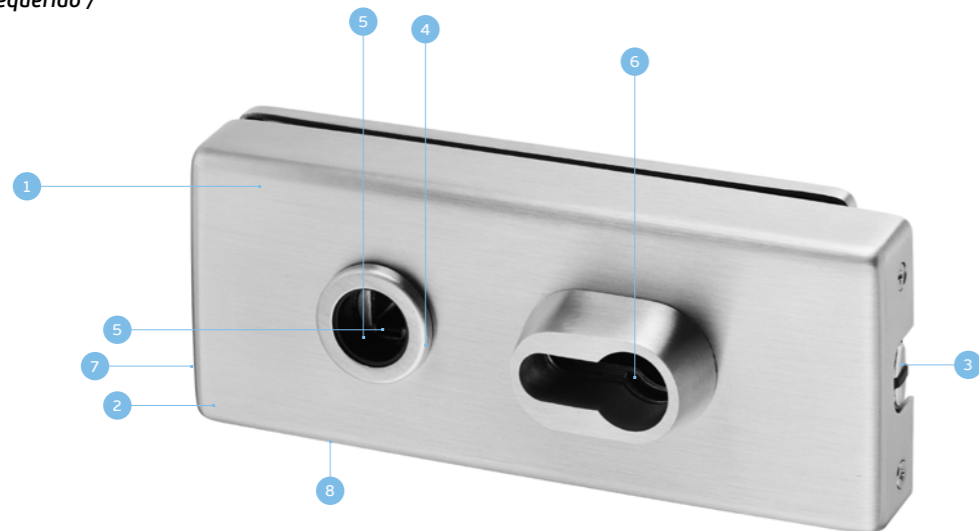

1. Fechadura reversível, pode ser alterada na instalação / Reversible lock, can be changed during installation / Cerradura reversible, se puede cambiar durante la instalación.

2. Tampas em aço inoxidável EN 1.4301-AISI 304 / Covers in stainless steel EN 1.4301-AISI 304 / Tapas en acero inoxidable EN 1.4301 - AISI 304.

3. Trinco magnético silencioso e reversível / Magnetic latch silent and reversible / Picaporte magnético silencioso y reversible.

4. Possível instalar com qualquer modelo de puxador JNF (puxador não incluído) / Can be installed with any JNF handle (lever handle not included) / Se puede instalar con cualquier modelo de manilla JNF (manilla no incluida).

5. Quadra com mola interior para eliminação da folga entre o puxador e a fechadura. Em aço inox EN 1.4301 / Handle square hole with a internal spring to avoid any break between the spindle and the lock. Made in stainless steel EN 1.4301 / Nueca en acero inox con muelle interior para eliminar la hholgura entre la manilla y a cerradura. En acero inox EN 1.4301.

6. Pode ser instalado qualquer cilindro de perfil europeu, recomendado 30x30. (cilindro não incluído) / Any European profile cylinder can be installed, recommended 30x30 (cylinder not included) / Se puede instalar cualquier cilindro de perfil europeo, recomendado 30x30 (cilindro no incluido).

7. Ajuste do ângulo do puxador, permite fazer compensação sendo o puxador mais ou menos pesado / Handle angle adjustment, allows you to compensate for a heavier or less heavy handle / Ajuste del ángulo de la manilla, permite compensar un manilla más o menos pesado.

8. Ajuste da força da mola de recuperação do puxador / Handle recovery spring force adjustment / Ajuste de la fuerza del resorte de recuperación de la manilla.

Ajuste do ângulo do puxador (PAT.Pendente) /
Handle angle adjustment (PAT. Pending) /
Ajuste del ángulo de la manilla (PAT. Pendiente (PAT.))

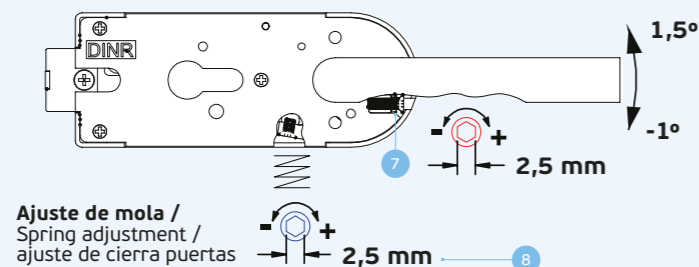

Ajuste de mola /
Spring adjustment /
ajuste de cierra puertas

MAGNETIC GLASS LOCKS

**FECHADURAS MAGNÉTICAS
PARA PORTAS DE VIDRO /
MAGNETIC LOCKS FOR GLASS DOORS /
CERRADURAS MAGNÉTICAS PARA
PUERTAS DE CRISTAL /**

**O TRINCO MAGNÉTICO GARANTE A
SEGURANÇA E SIMULTANEAMENTE
É SILENCIOSO /
MAGNETIC LATCH GUARANTEES SAFETY
AND AT THE SAME TIME IS SILENT /
EL PESTILLO MAGNÉTICO GARANTIZA
LA SEGURIDAD Y AL MISMO TIEMPO
ES SILENCIOSO.**



FECHADURAS PARA PORTAS DE VIDRO / LOCKS FOR GLASS DOORS / CERRADURAS PARA PUERTAS DE CRISTAL.

IN.20.337.Q

Fechadura magnética para vidro com função cilindro europeu para puxador rotativo de ambos os lados (possível aplicar qualquer puxador JNF / Magnetic Cylinder type glass lock to use with rotative lever handles both sides (apply any JNF lever handle) / Cerradura magnética para cristal con función cilindro europeo para usar con manillas rotativas en ambos lados. (aplicar cualquier manilla JNF)

MATERIAL: EN 1.4301 / AISI 304

ACABAMENTO / FINISH / ACABADO:
SATINADO / SATIN

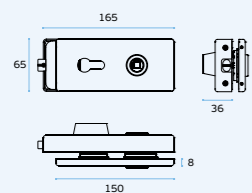

IN.20.340.Q

Fechadura magnética para vidro com função de passagem para puxador rotativo de ambos os lados (possível aplicar qualquer puxador JNF) / Magnetic Passage type glass lock to use with rotative lever handles both sides (apply any JNF lever handle) / Cerradura magnética para cristal con función de paso para usar con manillas rotativas en ambos lados. (aplicar cualquier manilla JNF)

MATERIAL: EN 1.4301 / AISI 304

ACABAMENTO / FINISH / ACABADO:
SATINADO / SATIN

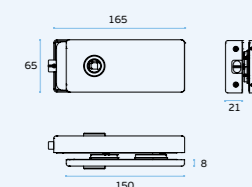

IN.20.341.Q

Fechadura magnética para vidro com função de passagem para puxador rotativo de ambos os lados (possível aplicar qualquer puxador JNF) / Magnetic Passage type glass lock to use with rotative lever handles both sides (apply any JNF lever handle) / Cerradura magnética para cristal con función de paso para usar con manillas rotativas en ambos lados. (aplicar cualquier manilla JNF)

MATERIAL: EN 1.4301 / AISI 304

ACABAMENTO / FINISH / ACABADO:
SATINADO / SATIN



IMAGEM / IMAGE:
IN.20.341.Q
IN.20.338.Q
IN.00.030.SR

IN.20.339.A

Testa reversível para aplicar no aro da porta / Reversible strike plate to apply in the door frame / Cerradero reversible para aplicar en el marco de la puerta.

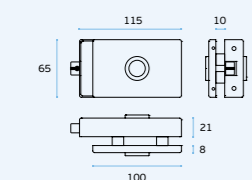

MATERIAL: EN 1.4301 / AISI 304

ACABAMENTO / FINISH / ACABADO:
STANDARD: SATINADO / SATIN / SATIN

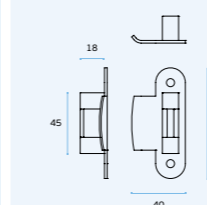

IN.20.339.B

Testa reversível para aplicar no aro da porta / Reversible strike plate to apply in the door frame / Cerradero reversible para aplicar en el marco de la puerta.



MATERIAL: EN 1.4301 / AISI 304

ACABAMENTO / FINISH / ACABADO:
STANDARD: SATINADO / SATIN / SATIN

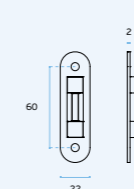

IN.20.338.Q

Caixa / testa de fechadura para portas de vidro (reversível) / Strike box for door lock for glass (reversible) / Caja / cerradura de cerradura (reversible).



MATERIAL: EN 1.4301 / AISI 304

ACABAMENTO / FINISH / ACABADO:
STANDARD: SATINADO / SATIN / SATIN

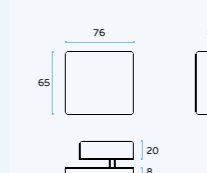

FECHADURAS PARA PORTAS DE VIDRO / LOCKS FOR GLASS DOORS / CERRADURAS PARA PUERTAS DE CRISTAL.

IN.20.331.Q

Fechadura para vidro com função cilindro europeu para puxador rotativo de ambos os lados (possível aplicar qualquer puxador JNF) / Cylinder type glass lock to use with rotative lever handles both sides (apply any JNF lever handle) / Cerradura para cristal con función cilindro europeo para usar con manillas rotativas en ambos lados. (aplicar cualquier manilla JNF)

MATERIAL: EN 1.4301 / AISI 304

ACABAMENTO / FINISH / ACABADO: SATINADO / SATIN

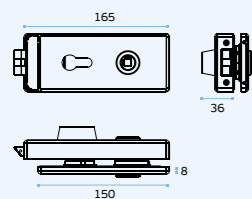

IN.20.331

Fechadura para vidro com função cilindro europeu para puxador rotativo de ambos os lados (possível aplicar qualquer puxador JNF) / Cylinder type glass lock to use with rotative lever handles both sides (apply any JNF lever handle) / Cerradura para cristal con función cilindro europeo para usar con manillas rotativas en ambos lados. (aplicar cualquier manilla JNF)

MATERIAL: EN 1.4301 / AISI 304

ACABAMENTO / FINISH / ACABADO: SATINADO / SATIN

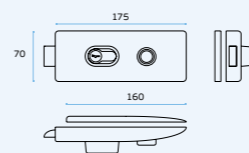

IN.20.334.Q

Fechadura para vidro com função WC para puxador rotativo de ambos os lados (possível aplicar qualquer puxador JNF) / Bathroom type glass lock to use with rotative lever handles both sides (apply any JNF lever handle) / Cerradura para cristal con función de baño para usar con manillas rotativas en ambos lados. (aplicar cualquier manilla JNF)

MATERIAL: EN 1.4301 / AISI 304

ACABAMENTO / FINISH / ACABADO: SATINADO / SATIN

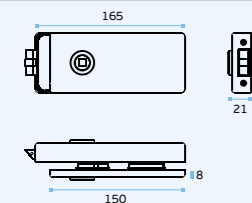

IN.20.334

Fechadura para vidro com função WC para puxador rotativo de ambos os lados (possível aplicar qualquer puxador JNF) / Bathroom type glass lock to use with rotative lever handles both sides (apply any JNF lever handle) / Cerradura para cristal con función de baño para usar con manillas rotativas en ambos lados. (aplicar cualquier manilla JNF)

MATERIAL: EN 1.4301 / AISI 304

ACABAMENTO / FINISH / ACABADO: SATINADO / SATIN

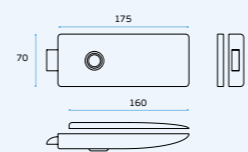

IN.20.333.Q

Caixa / testa de fechadura para portas de vidro (reversível) / Strike box for door lock for glass (reversible) / Caja / cerradura de cerradura (reversible).



MATERIAL: EN 1.4301 / AISI 304

ACABAMENTO / FINISH / ACABADO: STANDARD: SATINADO / SATIN / SATIN

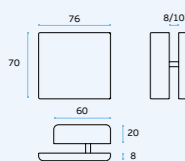

IN.20.332

Testa reversível para aplicar no aro da porta / Reversible strike plate to apply in the door frame / Cerradero reversible para aplicar en el marco de la puerta.

MATERIAL: EN 1.4301 / AISI 304

ACABAMENTO / FINISH / ACABADO: STANDARD: SATINADO / SATIN / SATIN

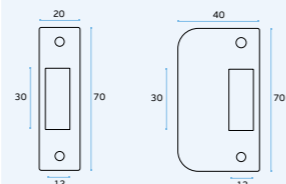

IN.20.332



IN.20.335

IN.20.336

Testa reversível para aplicar no aro da porta / Reversible strike plate to apply in the door frame / Cerradero reversible para aplicar en el marco de la puerta.

MATERIAL: EN 1.4301 / AISI 304

ACABAMENTO / FINISH / ACABADO: STANDARD: SATINADO / SATIN / SATIN

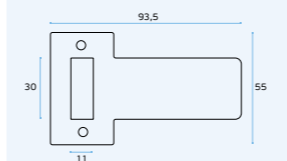

IN.20.333

Caixa / testa de fechadura para portas de vidro (reversível) / Strike box for door lock for glass (reversible) / Caja / cerradura de cerradura (reversible).



MATERIAL: EN 1.4301 / AISI 304

ACABAMENTO / FINISH / ACABADO: STANDARD: SATINADO / SATIN / SATIN

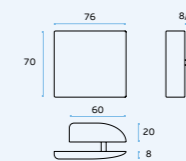

FECHADURAS PARA PORTAS DE VIDRO /
LOCKS FOR GLASS DOORS /
CERRADURAS PARA PUERTAS DE CRISTAL.



**DIN
TYPE
HEAVY
DUTY
GLASS
LOCKS**

**FECHADURA DESENVOLVIDAS PARA
AS SITUAÇÕES MAIS EXIGENTES /**
LOCK DEVELOPED FOR THE MOST
DEMANDING SITUATIONS /
**CERRADURA DESARROLLADA PARA
LAS SITUACIONES MÁS EXIGENTES /**

**FECHADURA COM TRINCO
SILENCIOSO /**
SILENT LATCH LOCK /
**CERRADURA DE PESTILLO
SILENCIOSO /**

**COMO CONFIGURAR
FECHADURA DE VIDRO JNF:**

**HOW TO CONFIGURE
JNF GLASS LOCK:**

**CÓMO CONFIGURAR LA
CERRADURA DE CRISTAL JNF:**

1º

1º Escolher o modelo de fechadura

1º Choose the lock model

1º Elige el modelo de cerradura



IN.20.3200.D
IN.20.3200.E



IN.20.3202.D
IN.20.3202.E



IN.20.3204.D
IN.20.3204.E



IN.20.3300.D
IN.20.3300.E



IN.20.3304.D
IN.20.3304.E

2º

2º Escolher o modelo de puxador com roseta

2º Choose the model of handle with rose

2º Elige el modelo de manilla con roseta



IN.00.185.RC08M



IN.00.028.B.RC08M



IN.00.028.RC08M



IN.00.078.QC08M



IN.00.122.QC08M



IN.00.107.QC08M



IN.00.141.RC08M



IN.00.030.RC08M



IN.00.413.RC08M



IN.00.153.QC08M



IN.00.178.QC08M



IN.00.108.QC08M

3º

3º Escolher o modelo de cilindro, se aplicável.

3º Choose the model of cylinder, if applicable.

3º Elige el modelo de cilindro, si corresponde.



IN.19.590.35.35



IN.19.540.30.30



IN.19.530.30.30



IN.19.522.30.30



IN.19.511.30.30



IN.19.501.30.30

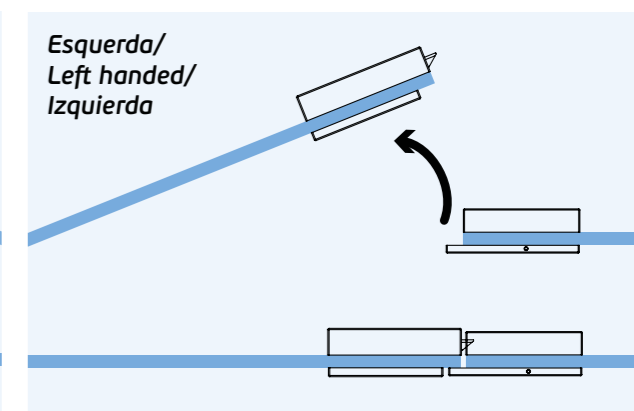
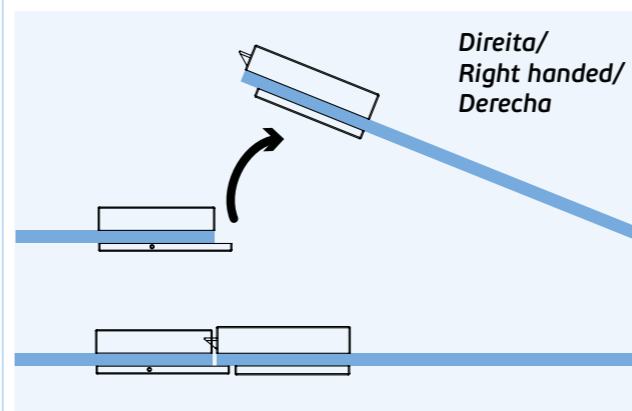

FECHADURAS PARA PORTAS DE VIDRO / LOCKS FOR GLASS DOORS / CERRADURAS PARA PUERTAS DE CRISTAL.

IN.20.3200.D IN.20.3200.E

Fechadura para puxador rotativo de ambos os lados (possível aplicar qualquer puxador JNF) / Door lock to use with rotative lever handles both sides (apply any JNF lever handle) / Cerradura para para usar con manillas rotativas en ambos lados. (aplicar cualquier manilla JNF)

MATERIAL: EN 1.4301 / AISI 304

ACABAMENTO / FINISH / ACABADO:
STANDARD: SATINADO / SATIN / SATIN

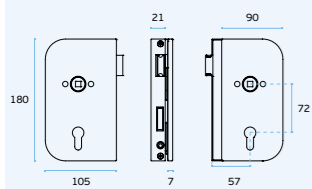

IN.20.3200.D



IN.20.3200.E



IN.20.3202.D IN.20.3202.E

Fechadura para puxador rotativo de ambos os lados com escudete de segurança (possível aplicar qualquer puxador JNF) / Door lock to use with rotative lever handles both sides with security keyhole (apply any JNF lever handle) / Cerradura para para usar con manillas rotativas en ambos lados con bocallave de seguridad (aplicar cualquier manilla JNF)

MATERIAL: EN 1.4301 / AISI 304

ACABAMENTO / FINISH / ACABADO:
STANDARD: SATINADO / SATIN / SATIN

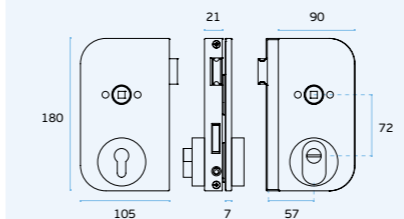

IN.20.3202.D



IN.20.3202.E



IN.20.3204.D IN.20.3204.E

Fechadura de casa de banho para puxador rotativo de ambos os lados (possível aplicar qualquer puxador JNF) / Bathroom door lock to use with rotative lever handles both sides (apply any JNF lever handle) / Cerradura para baño para para usar con manillas rotativas en ambos lados. (aplicar cualquier manilla JNF)

MATERIAL: EN 1.4301 / AISI 304

ACABAMENTO / FINISH / ACABADO:
STANDARD: SATINADO / SATIN / SATIN

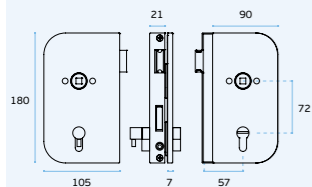

IN.20.3204.D



IN.20.3204.E



IN.20.3220.D IN.20.3220.E

Caixa / testa de fechadura para portas de vidro / Strike box for door lock for glass / Caja / cerradera de cerradura.

MATERIAL: EN 1.4301 / AISI 304

ACABAMENTO / FINISH / ACABADO:
STANDARD: SATINADO / SATIN / SATIN

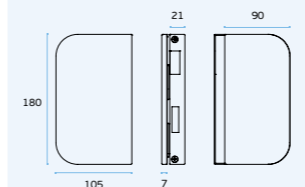

IN.20.3220.D



IN.20.3220.E



FECHADURAS PARA PORTAS DE VIDRO / LOCKS FOR GLASS DOORS / CERRADURAS PARA PUERTAS DE CRISTAL.

IN.20.3300.D
IN.20.3300.E

Fechadura para puxador rotativo de ambos lados (possível aplicar qualquer puxador JNF) / Door lock to use with rotative lever handles both sides (apply any JNF lever handle) / Cerradura para para usar con manillas rotativas en ambos lados. (aplicar cualquier manilla JNF)



IN.20.3300.D



IN.20.3300.E

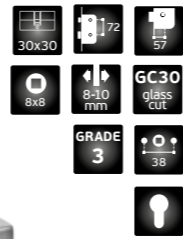

MATERIAL: EN 1.4301 / AISI 304

ACABAMENTO / FINISH / ACABADO: STANDARD: SATINADO / SATIN / SATIN

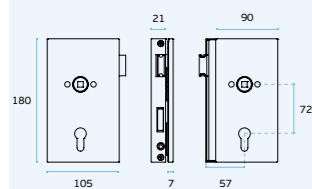

IN.20.3304.D
IN.20.3304.E

Fechadura de casa de banho para puxador rotativo de ambos os lados (possível aplicar qualquer puxador JNF) / Bathroom door lock to use with rotative lever handles both sides (apply any JNF lever handle) / Cerradura para baño para para usar con manillas rotativas en ambos lados. (aplicar cualquier manilla JNF)



IN.20.3304.D



IN.20.3304.E



MATERIAL: EN 1.4301 / AISI 304

ACABAMENTO / FINISH / ACABADO: STANDARD: SATINADO / SATIN / SATIN

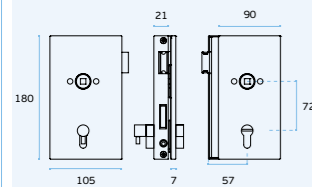

IN.20.3320.D
IN.20.3320.E

Caixa / testa de fechadura para portas de vidro / Strike box for door lock for glass / Caja / cerradero de cerradura.



IN.20.3320.D



IN.20.3320.E



MATERIAL: EN 1.4301 / AISI 304

ACABAMENTO / FINISH / ACABADO: STANDARD: SATINADO / SATIN / SATIN

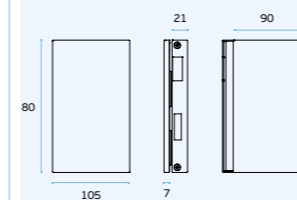

IN.20.3221

Testa para aplicar no aro da porta / Strike plate to apply in the door frame / Cerradero para aplicar en el marco de la puerta.

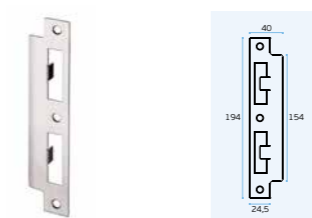

IN.20.900

Chapa testa com ajuste de trinco e protecção de aro (reversível) / Strike plate with adjustment of latch and door frame protection. (reversible) / Cerradero con ajuste de picaporte y protección en el marco de puerta. (regulable).

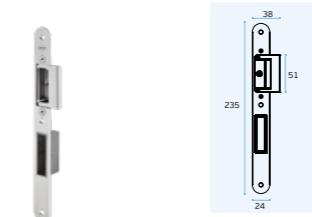

IN.20.903

Chapa testa ajustável e reversível / Adjustable and reversible strike plate / Cerradero regulable y reversible.

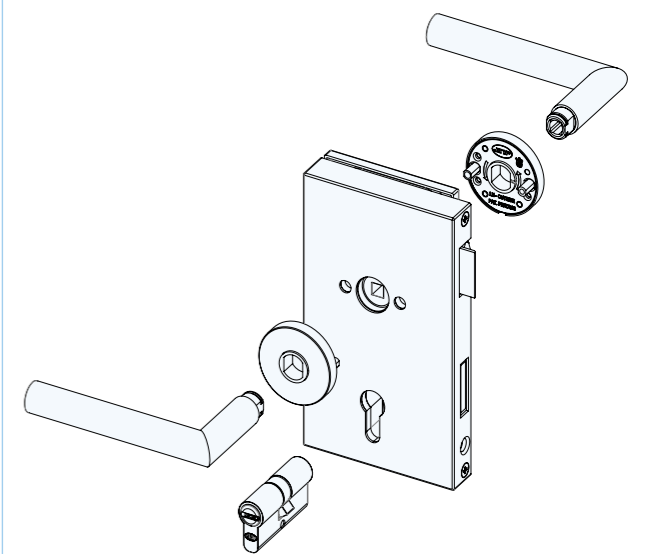
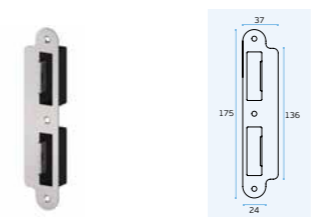

FECHADURAS PARA PORTAS DE VIDRO / LOCKS FOR GLASS DOORS / CERRADURAS PARA PUERTAS DE CRISTAL.

IN.81.130
Fechadura para
portas de vidro,
fornecida com meio
cilindro europeu /
Lock for glass door
supplied with half
european cylinder
/ Cerradura para
puertas de cristal
suministrada con
medio bombillo
europeo

NO
glass
cut

MATERIAL: EN 1.4301 / AISI 304

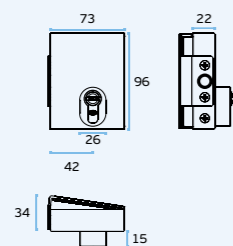
ACABAMENTO / FINISH / ACABADO:
STANDARD: SATINADO / SATIN / SATIN

IN.81.131
Caixa testa para
IN.81.130 /
Strike box for IN.81.130 /
Caja cerradera para
IN.81.130.

NO
glass
cut

MATERIAL: EN 1.4301 / AISI 304

ACABAMENTO / FINISH / ACABADO:
STANDARD: SATINADO / SATIN / SATIN

IMAGEM / IMAGE:
2X: IN.81.130
2X: IN.17.401

EASY GLASS LOCK NO NEED CUTOUT

FECHADURA DESENVOLVIDA PARA
INSTALAÇÃO FÁCIL, COM UMA
APLICAÇÃO SEM FURAÇÃO DE VIDROS /
LOCK DEVELOPED FOR EASY
INSTALLATION, WITH AN APPLICATION
WITHOUT GLASS DRILLING /
CERRADURA DESARROLLADA PARA FÁCIL
INSTALACIÓN, CON UNA APLICACIÓN SIN
PERFORACIÓN DEL CRISTAL /

IMAGEM / IMAGE:
2X: IN.81.130
2X: IN.81.131

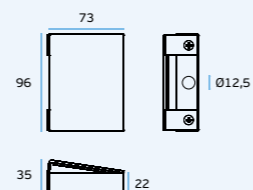
SISTEMA DE CONTROLO DE ACESSOS COM TECLADO NUMÉRICO PARA PORTAS EM VIDRO. FECHO AUTOMÁTICO, QUE GARANTE A SEGURANÇA DO SISTEMA /

CARACTERÍSTICAS PRINCIPAIS:

- Tecnologia keypad.
- Possibilidade de escolher diferentes modelos de puxador da gama JNF.
- Master user password: 3 grupos.
- Normal user password: 7 grupos.
- Temporary user password: 1 grupo.
- Senha de 3-12 dígitos.
- Puxador fica livre do lado exterior.
- Possibilidade de passar para modelo de fechadura de passagem.
- Compatível com cilindros de perfil europeu.
- Quadra: 8mm.
- Possibilidade de abertura com chave mecânica (opcional).
- Possibilidade de chaves iguais nos cilindros de emergência (opcional).
- Corpo exterior em aço inoxidável AISI 304 / EN 1.4301.
- Rotação do puxador: 45°.
- Compatível com portas de 10 a 12mm de espessura.
- Distância entre o puxador e cilindro: 72mm.
- 3 pilhas alcalinas - LR03 - 1,5v AAA (Opcional 3 baterias de lítio FR03 - AAA 1,5v)
- Consumo estático: 13uA
- Consumo dinâmico: 220mA
- Número de ciclos: de 40,000 a 70,000, com um conjunto de baterias (variável conforme condições ambientais)
- Aviso bateria baixa: 200 ciclos, após 1º aviso luminoso

Condições ambientais:
 Temperatura: -15° a 55°C
 Humidade: 20 a 80%

IN.27.164

Alimentador externo para fechadura electrónica IN.27.100, IN.27.102 e IN.27.200 /
 External power supply for electronic lock IN.27.100, IN.27.102 and IN.27.200 / Alimentador externo para cerradura electrónica IN.27.100, IN.27.102 y IN.27.200 /



Manual de instalação
 Installation guide
 Guía de instalación



ACCESS CONTROL SYSTEM WITH KEYPAD FOR GLASS DOORS. AUTOMATIC LATCH, WHICH GUARANTEES THE SECURITY OF THE SYSTEM /

MAIN FEATURES:

- Keypad technology.
- Possibility to choose different lever handles from JNF range.
- Master User Password: 3 groups
- Normal User Password: 7 groups
- Temporary User Password: 1 group
- Password length: 3-12 digits password
- The handle is free on the outside.
- Possibility to switch to passage type lock mode.
- Compatible with european profile cylinders.
- Spindle: 8mm
- Possibility of key alike in the emergency cylinders (optional).
- Out body made in stainless steel AISI 304 / EN 1.4301.
- Rotation of the handle: 45°
- Suitable for doors with 10 to 12mm thickness.
- Distance between the handle and cylinder: 72mm.
- 3 alkaline batteries - LR03 - 1,5v AAA (Optional 3 lithium batteries FR03 - AAA 1,5v).
- Static consumption: 13uA
- Dynamic consumption: 220mA
- Number of openings: from 40,000 to 70,000 with 1 set of batteries (It depends on the environment conditions).
- Low battery warning: 200 cycles after first warning.

Environmental conditions:
 Temperature: -15° a 55°C
 Humidity: 20 a 80%

SISTEMA DE CONTROL DE ACCESOS CON TECLADO NUMÉRICO PARA PUERTAS DE CRISTAL. CIERRE AUTOMÁTICO, QUE GARANTIZA LA SEGURIDAD DEL SISTEMA /

CARACTERÍSTICAS PRINCIPALES:

- Posibilidad de elegir diferentes manillas de la línea JNF.
- Master User Password: 3 grupos.
- Normal User Password: 7 grupos.
- Temporary User Password: 1 grupo.
- Contraseña 3-12 dígitos.
- La manilla está libre en el exterior.
- Posibilidad de cambiar al modo de paso.
- Posibilidad de instalar en puertas existentes con cerradura.
- Cuadrado: 8mm
- Posibilidad de llaves iguales en los cilindros de emergencia (opcional).
- Cuerpo exterior en acero inoxidable AISI 304 / EN 1.4301.
- Rotación de la manilla: 45°.
- Para puertas de 10 a 12mm de espesor.
- Distancia entre la manilla y cilindro: 72mm.
- 3 pilas alcalinas - LR03 - 1,5v AAA (Opcional 3 pilas de litio FR03 - AAA 1,5v)
- Consumo estático: 13uA
- Consumo dinámico: 220mA
- Número de ciclos: de 40,000 hasta 70,000 con un juego de pilas (depende de las condiciones del medio ambiente)
- Aviso de batería baja: 200 ciclos después de la primera advertencia

Condiciones ambientales:
 Temperatura: -15° a 55°C
 Humedad: 20 a 80%

ACCESS CONTROL FOR GLASS DOORS

CONTROLO DE ACESSO COM TECLADO NUMÉRICO. AUTÓNOMO E FÁCIL DE PROGRAMAR /
 ACCESS CONTROL WITH NUMERIC KEYPAD. AUTONOMOUS AND EASY TO PROGRAM /
 CONTROL DE ACCESO CON TECLADO NUMÉRICO. AUTÓNOMO Y FÁCIL DE PROGRAMAR /

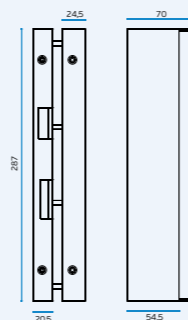
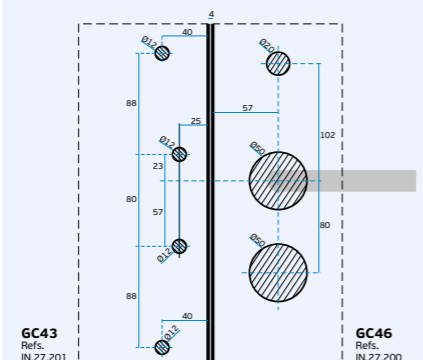
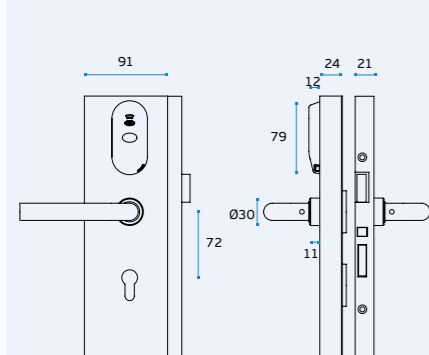

SISTEMAS DE CONTROLO DE ACESSOS COM TECLADO / KEYPAD ACCESS CONTROL SYSTEMS / SISTEMAS DE CONTROL DE ACCESOS CON TECLADO.

IN.27.202.KD

DIREITA /
RIGHT HAND / DERECHA

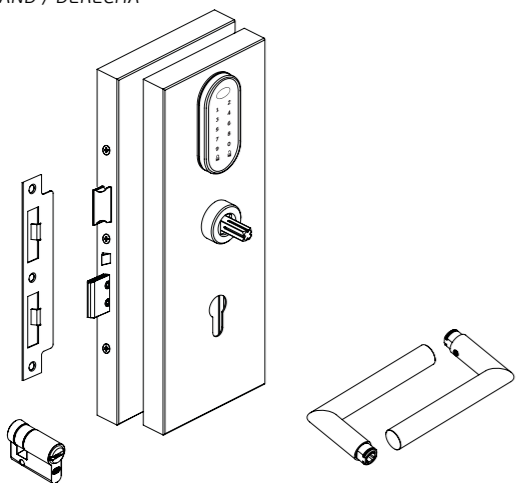

IN.27.202.KE

ESQUERDA /
LEFT HAND / IZQUIERDA

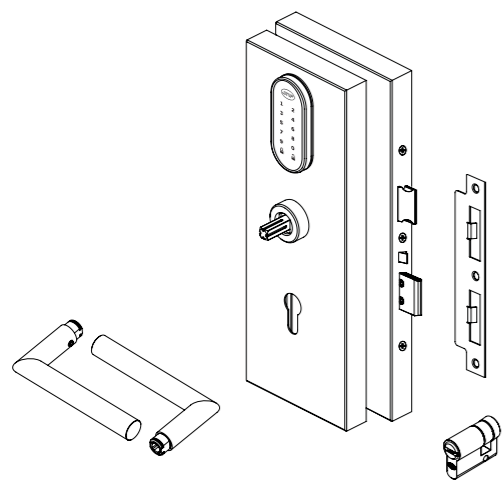

Kit completo de fechadura de controlo de acessos para vidro de 10 a 12mm

Puxador IN.00.030.SR.
Meio cilindro europeu IN.19.S11.10.50, só acessível pelo exterior.

Fecho automático que garante a segurança do sistema de controlo de acesso.

Coberturas em aço inoxidável AISI 304 / EN 1.4301 disponíveis em 5 acabamentos, satinado (standard), PVD Titanium (preto, dourado, cobre e chocolate)

Complete access control lock Set for 10 to 12mm glass

Handle IN.00.030.SR.
Half european cylinder IN.19.S11.10.50, only accessible from the outside.

Automatic latch that guarantees the security of the access control system.

AISI 304 / EN 1.4301 stainless steel covers available in 5 finishes, satin (standard), PVD Titanium (black, gold, copper and chocolate)

Kit completo de cerradura de control de acceso para cristal de 10 a 12 mm

Manilla IN.00.030.SR.
Medio cilindro europeo IN.19.S11.10.50, solo accesible desde el exterior.

Cierre automático que garantiza la seguridad del sistema de control de acceso.

Tapas de acero inoxidable AISI 304 / EN 1.4301 disponibles en 5 acabados, satinado (estándar), PVD Titanium (negro, dorado, cobre y chocolate)

IN.27.202.D

DIREITA /
RIGHT HAND / DERECHA

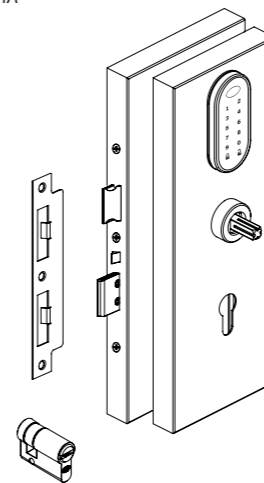

IN.27.202.E

ESQUERDA /
LEFT HAND / IZQUIERDA

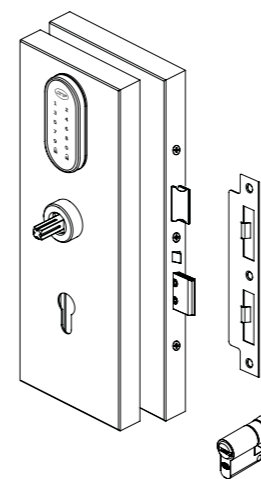

Kit de fechadura de controlo de acessos para vidro de 10 a 12mm
Pode ser aplicado qualquer modelo de puxador JNF (puxador não incluído)
Meio cilindro europeu IN.19.S11.10.50, só acessível pelo exterior.
Fecho automático que garante a segurança do sistema de controlo de acesso.
Coberturas em aço inoxidável AISI 304 / EN 1.4301 disponíveis em 5 acabamentos, satinado (standard), PVD Titanium (preto, dourado, cobre e chocolate)

Access control lock Set for 10 to 12mm glass. Can be installed any JNF door handle (not included). Half european cylinder IN.19.S11.10.50, only accessible from the outside. Automatic latch that guarantees the security of the access control system. AISI 304 / EN 1.4301 stainless steel covers available in 5 finishes, satin (standard), PVD Titanium (black, gold, copper and chocolate)

Kit de cerradura de control de acceso para cristal de 10 a 12 mm
Puede ser instalada cualquiera manilla JNF (no incluida) Medio cilindro europeo IN.19.S11.10.50, solo accesible desde el exterior.
Cierre automático que garantiza la seguridad del sistema de control de acceso.
Tapas de acero inoxidable AISI 304 / EN 1.4301 disponibles en 5 acabados, satinado (estándar), PVD Titanium (negro, dorado, cobre y chocolate)

IN.27.201.D

DIREITA /
RIGHT HAND / DERECHA

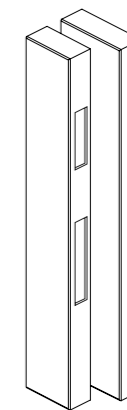

IN.27.201.E

ESQUERDA /
LEFT HAND / IZQUIERDA

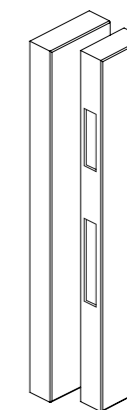

Caixa testa para vidro de 10 ou 12mm.
Aplicável com IN.27.202 /

Strike box for glass with 10 or 12mm.
Suitable for IN.27.202 /

Caja cerradero para cristal de 10 o 12mm.
Aplicable con IN.27.202.

SISTEMAS DE CONTROLO DE ACESSOS RFID - MIFARE® / RFID - MIFARE® ACCESS CONTROL SYSTEMS / SISTEMAS DE CONTROL DE ACCESOS RFID - MIFARE®.

IN.27.200.KD

DIREITA /
RIGHT HAND / DERECHA

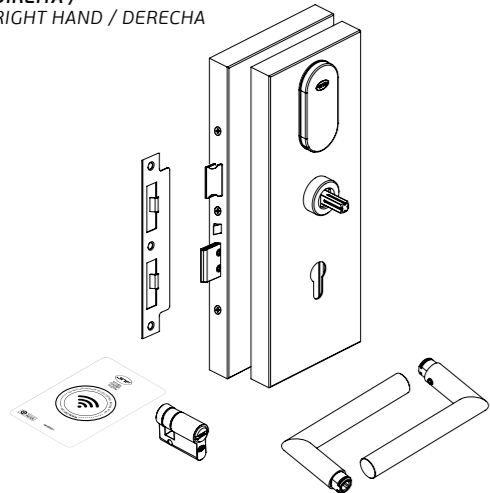

IN.27.200.KE

ESQUERDA /
LEFT HAND / IZQUIERDA

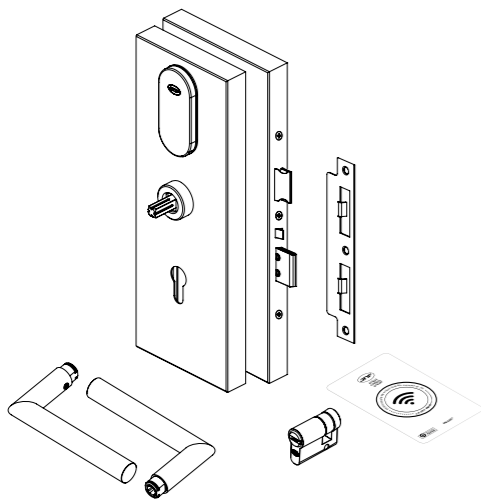

.TB .TG .TCO .TCH

Kit completo de fechadura de controlo de acessos para vidro de 10 a 12mm.

Puxador IN.00.030.SR.
Meio cilindro europeu IN.19.S11.10.50,
só acessível pelo exterior.

Fecho automático que garante a segurança do sistema de controlo de acesso.

Coberturas em aço inoxidável AISI 304 / EN 1.4301 disponíveis em 5 acabamentos, satinado (standard), PVD Titanium (preto, dourado, cobre e chocolate)

Complete access control lock set for 10 to 12mm glass.

Handle IN.00.030.SR.
Half european cylinder IN.19.S11.10.50,
only accessible from the outside.

Automatic latch that guarantees the security of the access control system.

AISI 304 / EN 1.4301 stainless steel covers available in 5 finishes, satin (standard), PVD Titanium (black, gold, copper and chocolate)

Kit completo de cerradura de control de acceso para cristal de 10 a 12mm.

Manilla IN.00.030.SR.
Medio cilindro europeo IN.19.S11.10.50,
solo accesible desde el exterior.

Cierre automático que garantiza la seguridad del sistema de control de acceso.

Tapas de acero inoxidable AISI 304 / EN 1.4301 disponibles en 5 acabados, satinado (estándar), PVD Titanium (negro, dorado, cobre y chocolate)

ACCESS CONTROL SYSTEM FOR GLASS DOORS

SISTEMA DE CONTROLO DE ACESSOS COM LEITOR RFID MIFARE® PARA PORTAS EM VIDRO. FECHO AUTOMÁTICO, QUE GARANTE A SEGURANÇA DO SISTEMA / ACCESS CONTROL SYSTEM WITH MIFARE® RFID READER FOR GLASS DOORS. AUTOMATIC LATCH, WHICH GUARANTEES THE SECURITY OF THE SYSTEM / SISTEMA DE CONTROL DE ACCESOS CON LECTOR RFID MIFARE® PARA PUERTAS DE CRISTAL. CIERRE AUTOMÁTICO, QUE GARANTIZA LA SEGURIDAD DEL SISTEMA /



GLASS FREE SYSTEM

SISTEMAS DE CONTROLO DE ACESSOS RFID - MIFARE® /

RFID - MIFARE® ACCESS CONTROL SYSTEMS /

SISTEMAS DE CONTROL DE ACCESOS RFID - MIFARE®.

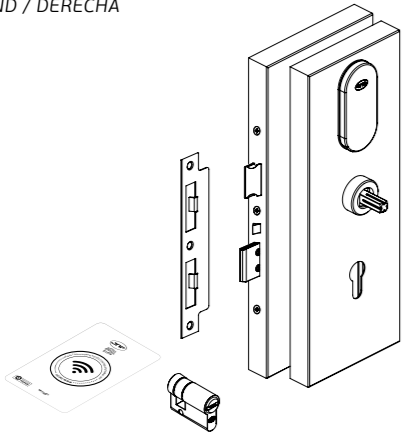
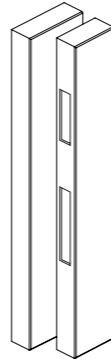
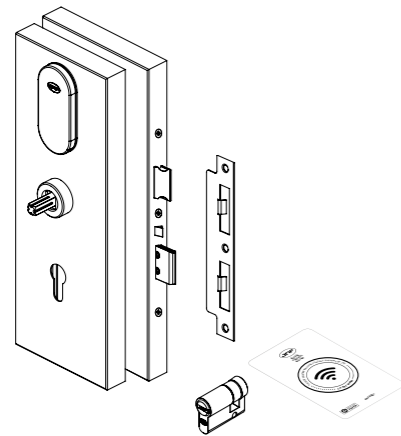
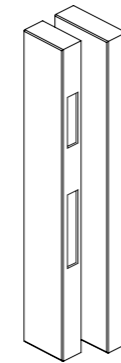
IN.27.200.DDIREITA /
RIGHT HAND / DERECHA**IN.27.201.D**DIREITA /
RIGHT HAND / DERECHA**IN.27.200.E**ESQUERDA /
LEFT HAND / IZQUIERDA**IN.27.201.E**ESQUERDA /
LEFT HAND / IZQUIERDA

.TB .TG .TCO .TCH

Kit de fechadura de controlo de acessos para vidro de 10 a 12mm
Pode ser aplicado qualquer modelo de puxador JNF (puxador não incluído)
Meio cilindro europeu IN.19.S11.10.50, só acessível pelo exterior.
Fecho automático que garante a segurança do sistema de controlo de acesso.
Coberturas em aço inoxidável EN 1.4301 - AISI 304 disponíveis em 5 acabamentos, satinado (standard), PVD Titanium (preto, dourado, cobre e chocolate)

Access control lock Set for 10 to 12mm glass. Can be installed any JNF door handle (not included). Half european cylinder IN.19.S11.10.50, only accessible from the outside. Automatic latch that guarantees the security of the access control system. EN 1.4301 - AISI 304 stainless steel covers available in 5 finishes, satin (standard), PVD Titanium (black, gold, copper and chocolate)

Kit de cerradura de control de acceso para cristal de 10 a 12mm
Puede ser instalada cualquiera manilla JNF (no incluida) Medio cilindro europeo IN.19.S11.10.50, solo accesible desde el exterior. Cierre automático que garantiza la seguridad del sistema de control de acceso. Tapas de acero inoxidable EN 1.4301 - AISI 304 disponibles en 5 acabados, satinado (estándar), PVD Titanium (negro, dorado, cobre y chocolate)

.TB .TG .TCO .TCH

Caixa testa para vidro de 10 ou 12mm.
Aplicável com IN.27.200 /

Strike box for glass with 10 or 12mm.
Suitable for IN.27.200 /

Caja cerradero para cristal de 10 o 12mm.
Aplicable con IN.27.200.

IN.27.153Cartão plástico genérico /
Plastic generic card /
Tarjeta plástica genérica.**IN.27.154**Cartão plástico autorização /
Plastic authorization card /
Tarjeta plástica de autorización.**IN.27.152**Cartão plástico de registos de informação /
Plastic data register card /
Tarjeta plástica de registros de información.**IN.27.153.B**Cartão plástico genérico branco /
Plastic white generic card /
Tarjeta plástica genérica blanca.**IN.27.168**Cartão genérico em papel reciclado /
Generic card in recycled paper /
Tarjeta genérica en papel reciclado**IN.27.169**Cartão de autorização em papel reciclado /
Authorization card in recycled paper /
Tarjeta de autorización en papel reciclado**IN.27.161**Keytag genérico com chip MIFARE® /
Generic keytag with MIFARE® chip /
Keytag generica con chip MIFARE®.

MIFARE®

IN.27.157Autocolante com chip MIFARE® /
Sticker with MIFARE® chip /
Pegatina con chip MIFARE®.

MIFARE®

IN.27.165._Pulseira com keytag /
Bracelet with keytag /
Pulsera con keytag.

IN.27.165.G



IN.27.165.B



IN.27.165.A

FECHADURAS PARA VIDRO / LOCKS FOR GLASS / CERRADURAS PARA CRISTAL.



IN.20.350
Testa para fechadura de portas de correr em vidro para aplicar com IN.20.349 / Strike box for sliding glass doors to use with IN.20.349 / Cerradero para puertas correderas de cristal para usar con IN.20.349.



IN.20.349
Fechadura para portas de correr em vidro com escudete de segurança e testa para parede. (cilindro não incluído) / Lock for sliding glass doors with security keyhole and strike plate for the wall. (cylinder not included) / Cerradura para puertas correderas de cristal con escudo de seguridad y cerradero para pared. (cilindro no incluido)



IN.16.318
Concha com puxador retráctil para vidro / Flush handle with retractable handle for glass / Cazoleta con manilla retráctil para cristal.



IN.16.322
Concha para portas de correr de vidro / Flush handle for sliding glass doors / Cazoleta para puertas correderas de cristal.

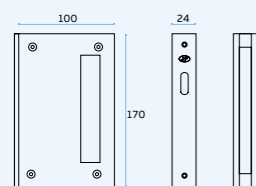

MATERIAL: EN 1.4301 / AISI 304
ACABAMENTO / FINISH / ACABADO: STANDARD: SATINADO / SATIN / SATIN

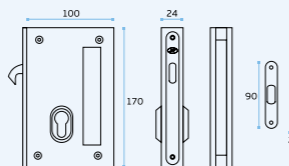

MATERIAL: EN 1.4301 / AISI 304
ACABAMENTO / FINISH / ACABADO: STANDARD: SATINADO / SATIN / SATIN

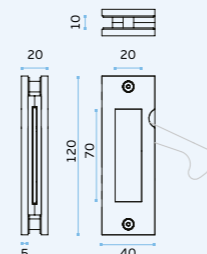

MATERIAL: EN 1.4301 / AISI 304
FINISH: SATINADO / SATIN / SATIN
OPTIONAL: PVD TITANIUM

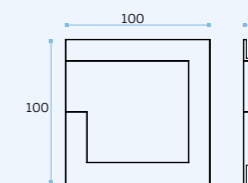

MATERIAL: EN 1.4301 / AISI 304
FINISH: SATINADO / SATIN / SATIN
OPTIONAL: PVD TITANIUM

ASAS DE PORTA PARA VIDRO / PULL HANDLES FOR GLASS DOORS / MANILLONES PARA PUERTAS DE CRISTAL.

ASAS DUPLAS PARA PORTAS DE VIDRO COM FECHADURA INTEGRADA, PERMITE O FECHO COM CHAVE PELO EXTERIOR. O SISTEMA DE BLOQUEIO TRABALHA COM UM CILINDRO EUROPEU, PERMITINDO A TROCA FÁCIL. ALTO NÍVEL DE SEGURANÇA E SISTEMAS DE MESTRAGEM OU MESMO GRUPOS DE CHAVES IGUAIS /

DOUBLE PULL HANDLES FOR GLASS DOORS WITH INTEGRATED LOCK, ALLOWS THE LOCKING WITH THE KEY FROM OUTSIDE. THE LOCKING SYSTEM WORKS WITH A EUROPEAN CYLINDER, ALLOWING FOR EASY EXCHANGE. HIGH LEVEL OF SECURITY AND MASTERING SYSTEMS OR EVEN GROUPS OF IDENTICAL KEYS /

ASAS DOBLES PARA PUERTAS DE CRISTAL CON CERRADURA INTEGRADA, PERMITE EL CIERRE CON LLAVE POR EL EXTERIOR. EL SISTEMA DE BLOQUEO TRABAJA CON UN CILINDRO EUROPEO, PERMITIENDO EL INTERCAMBIO FÁCIL. ALTO NIVEL DE SEGURIDAD Y SISTEMAS DE ENSAYO O INCLUSO GRUPOS DE LLAVES IGUALES /



ASAS DE PORTA PARA VIDRO / PULL HANDLES FOR GLASS DOORS / MANILLONES PARA PUERTAS DE CRISTAL.

IN.07.103.D

Asas de porta com fechadura
de 2 pontos para vidro /
Pull handles with 2 point lock
for glass doors. /
Manillones con cerradura
de 2 puntos para cristal. /

MATERIAL: EN 1.4301 / AISI 304

ACABAMENTO / FINISH / ACABADO:
STANDARD: SATINADO / SATIN / SATIN

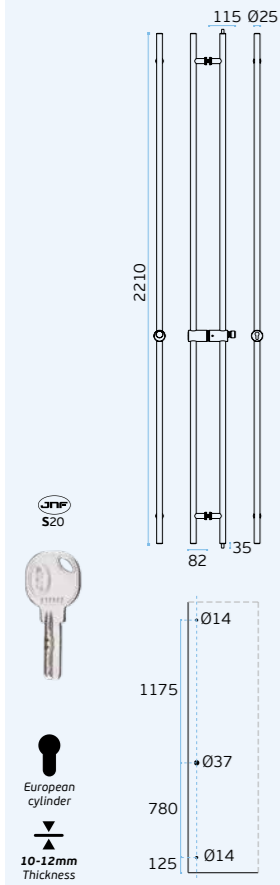

SEMI SOLID ■

ENTALHE /
GLASS CUT / TALADRO EN EL CRISTAL

GC56

**Possibilidade de fazer
mestragens. Inclui copo para
chão com cobertura / Possibility to
make master key system.
Includes a dust cover for the floor /
Posibilidad de hacer planos de
maestramiento. Incluye vaso al suelo
con cubierta.**



IN.07.103.E

Asas de porta com fechadura
de 2 pontos para vidro. Medidas
especiais. / Pull handles with
2 point lock for glass doors.
Special measure. / Manillones con
cerradura de 2 puntos para cristal.
Medida especial. /

MATERIAL: EN 1.4301 / AISI 304

ACABAMENTO / FINISH / ACABADO:
STANDARD: SATINADO / SATIN / SATIN

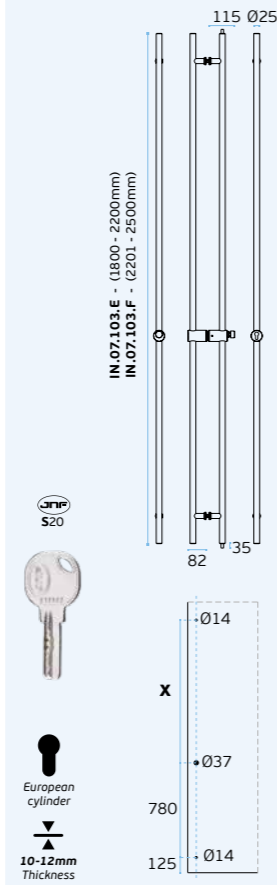

SEMI SOLID ■

ENTALHE /
GLASS CUT / TALADRO EN EL CRISTAL

GC56

**Possibilidade de fazer
mestragens. Inclui copo para
chão com cobertura / Possibility to
make master key system. Includes a
dust cover for the floor /
Posibilidad de hacer planos de
maestramiento. Incluye vaso
al suelo con cubierta.**



IN.07.101.D

Asas de porta com
fechadura de para vidro /
Pull handles with lock
for glass doors. /
Manillones con cerradura
de para cristal. /

MATERIAL: EN 1.4301 / AISI 304

ACABAMENTO / FINISH / ACABADO:
STANDARD: SATINADO / SATIN / SATIN

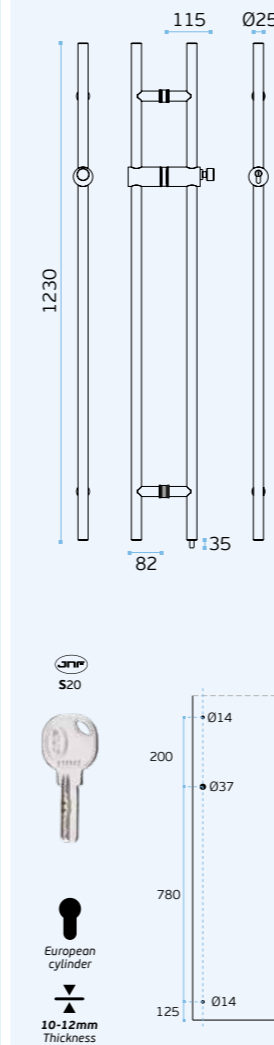

SEMI SOLID ■

ENTALHE /
GLASS CUT / TALADRO EN EL CRISTAL

GC55

**Possibilidade de fazer
mestragens. Inclui copo para
chão com cobertura / Possibility to
make master key system. Includes a
dust cover for the floor / Possibilidad
de hacer planos de maestramiento.
Incluye vaso al suelo con cubierta.**



IN.07.105.D

Asas de porta com
fechadura de para vidro /
Pull handles with lock
for glass doors. /
Manillones con cerradura
de para cristal. /

MATERIAL: EN 1.4301 / AISI 304

ACABAMENTO / FINISH / ACABADO:
STANDARD: SATINADO / SATIN / SATIN

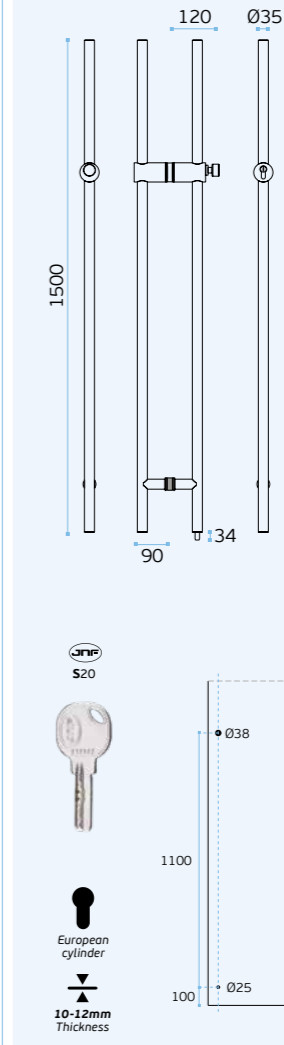

SEMI SOLID ■

ENTALHE /
GLASS CUT / TALADRO EN EL CRISTAL

GC57

**Possibilidade de fazer
mestragens. Inclui copo para
chão com cobertura / Possibility to
make master key system. Includes a
dust cover for the floor / Possibilidad
de hacer planos de maestramiento.
Incluye vaso al suelo con cubierta.**



PUXADORES FIXOS PARA PORTAS DE VIDRO / FIXED KNOBS FOR GLASS DOORS / POMOS FIJOS PARA PUERTAS DE CRISTAL.



IN.00.172.V
Puxador para portas de vidro /
Knob for glass doors /
Pomo para puertas de cristal.

.TB .TG .TCO .TCH

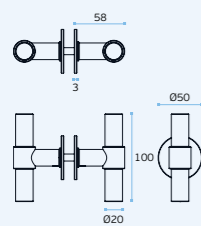

MATERIAL: EN 1.4301 / AISI 304

ACABAMENTO / FINISH / ACABADO:
STANDARD: SATINADO / SATIN / SATIN

OPTIONAL: PVD TITANIUM COATED

.TB / .TG / .TCO / .TCH



IN.00.172.V.KN
Puxador para portas de vidro /
Knob for glass doors /
Pomo para puertas de cristal.

.TB .TG .TCO .TCH

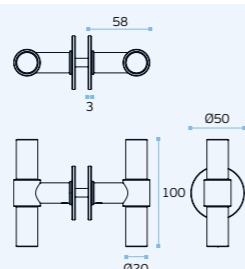

MATERIAL: EN 1.4301 / AISI 304

ACABAMENTO / FINISH / ACABADO:
STANDARD: SATINADO / SATIN / SATIN

OPTIONAL: PVD TITANIUM COATED

.TB / .TG / .TCO / .TCH



IN.00.172.16.V
Puxador para portas de vidro /
Knob for glass doors /
Pomo para puertas de cristal.

.TB .TG .TCO .TCH

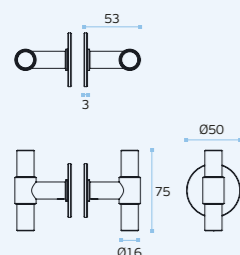

MATERIAL: EN 1.4301 / AISI 304

ACABAMENTO / FINISH / ACABADO:
STANDARD: SATINADO / SATIN / SATIN

OPTIONAL: PVD TITANIUM COATED

.TB / .TG / .TCO / .TCH



IN.00.172.16.V.KN
Puxador para portas de vidro /
Knob for glass doors /
Pomo para puertas de cristal.

.TB .TG .TCO .TCH

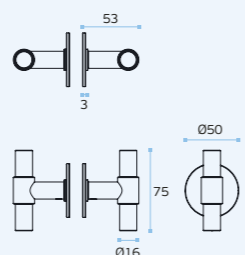

MATERIAL: EN 1.4301 / AISI 304

ACABAMENTO / FINISH / ACABADO:
STANDARD: SATINADO / SATIN / SATIN

OPTIONAL: PVD TITANIUM COATED

.TB / .TG / .TCO / .TCH



WATCH SERIES

A NOVA SERIE WATCH FOI INSPIRADA PELAS CDORADOAS DOS RELÓGIOS E ATRAVÉS DO SEU ACABAMENTO RECARTEADO TRANSMITE UM CARÁTER DE PRECISÃO E UM TOQUE AGRAVÁVEL NA SUA UTILIZAÇÃO. AS SUAS FORMAS ROBUSTAS, JUNTAMENTE COM A SUA TEXTURA, CONFEREM UM VISUAL FORTE ADEQUADO A AMBIENTES SOFISTICADOS.

SERIE WATCH WAS INSPIRED BY THE CROWNS OF THE WATCHES AND THROUGH ITS KNURLED FINISH IT CONVEYS A CHARACTER OF PRECISION AND A PLEASANT TOUCH IN ITS USE. ITS STURDY SHAPES, TOGETHER WITH ITS TEXTURE, GIVE A STRONG LOOK SUITABLE FOR SOPHISTICATED ENVIRONMENTS.

LA NUEVA WATCH SERIES SE INSPIRÓ EN LAS CDORADONAS DE LOS RELOJES Y, A TRAVÉS DE SU ACABADO MOLETEADO, TRANSMITE UN CARÁCTER DE PRECISIÓN Y UN TACTO AGRAVABLE AL USARLO. SUS FORMAS ROBUSTAS, JUNTO CON SU TEXTURA, LE CONFIEREN UN ASPECTO FUERTE ADEQUADO A AMBIENTES SOFISTICADOS.

PUXADORES FIXOS PARA PORTAS DE VIDRO / FIXED KNOBS FOR GLASS DOORS / POMOS FIJOS PARA PUERTAS DE CRISTAL.



IN.00.099.V

Puxador para portas de vidro /
Knob for glass doors /
Pomo para puertas de cristal.

.TB .TG .TCO .TCH

Ø12
mm

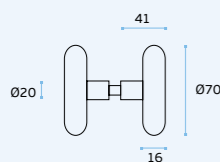

MATERIAL: EN 1.4301 / AISI 304

ACABAMENTO / FINISH / ACABADO:

STANDARD: SATINADO / SATIN / SATIN

OPTIONAL: PVD TITANIUM COATED



IN.00.099.V.TB
pvd titanium black



IN.00.099.V.TG
pvd titanium gold



IN.00.099.V.TCO
pvd titanium copper



IN.00.099.V.TCH
pvd titanium chocolate



IN.00.099.V.P

Puxador para portas de vidro /
Knob for glass doors /
Pomo para puertas de cristal.

Ø12
mm

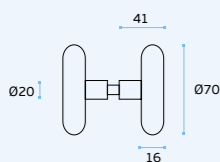

MATERIAL: EN 1.4301 / AISI 304

ACABAMENTO / FINISH / ACABADO:

STANDARD: SATINADO / SATIN / SATIN

OPTIONAL: PVD TITANIUM COATED



DOUBLE KNOB FOR GLASS DOORS

PUXADOR DE PORTA FIXO DESENHADO
A PENSAR NA ERGONOMIA /
FIXED DOOR KNOB DESIGNED WITH
ERGONOMICS IN MIND /
POMO DE PUERTA FIJO DISEÑADO
PENSANDO EN LA ERGONOMÍA.

PUXADORES PARA PORTAS DE VIDRO / KNOBS FOR GLASS DOORS / POMOS PARA PUERTAS DE CRISTAL.



IN.75.042

Puxador de porta duplo anti-vandalismo /
Double door knob with anti-vandalism fixing /
Tirador de puerta doble anti-vandalismo.

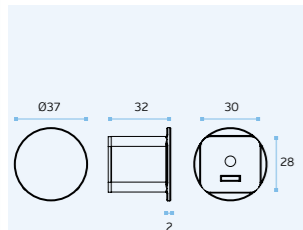

MATERIAL: EN 1.4301 / AISI 304

ACABAMENTO / FINISH / ACABADO:
STANDARD: SATINADO / SATIN / SATIN

OPTIONAL: PVD TITANIUM COATED



IN.75.042.TB
pvd titanium black



IN.75.042.TG
pvd titanium gold



IN.75.042.TCO
pvd titanium copper



IN.75.042.TCH
pvd titanium chocolate



IN.75.040

Puxador de porta duplo anti-vandalismo /
Double door knob with anti-vandalism fixing /
Tirador de puerta doble anti-vandalismo.

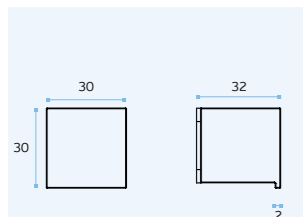

MATERIAL: EN 1.4301 / AISI 304

ACABAMENTO / FINISH / ACABADO:
STANDARD: SATINADO / SATIN / SATIN

OPTIONAL: PVD TITANIUM COATED



IN.75.041

Puxador de porta duplo anti-vandalismo /
Double door knob with anti-vandalism fixing /
Tirador de puerta doble anti-vandalismo.

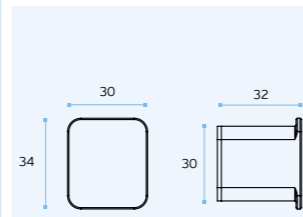

MATERIAL: EN 1.4301 / AISI 304

ACABAMENTO / FINISH / ACABADO:
STANDARD: SATINADO / SATIN / SATIN

OPTIONAL: PVD TITANIUM COATED

DOUBLE KNOB FOR GLASS

**PUXADOR DUPLO PARA PORTAS DE
VIDRO COM SISTEMA DE FIXAÇÃO
ANTIVANDALISMO /**
DOUBLE KNOB FOR GLASS DOORS WITH
ANTI-VANDALISM FIXING SYSTEM /
TIRADOR DOBLE PARA PUERTAS DE
CRISTAL CON SISTEMA DE FIJACIÓN
ANTIVANDÁLICA.

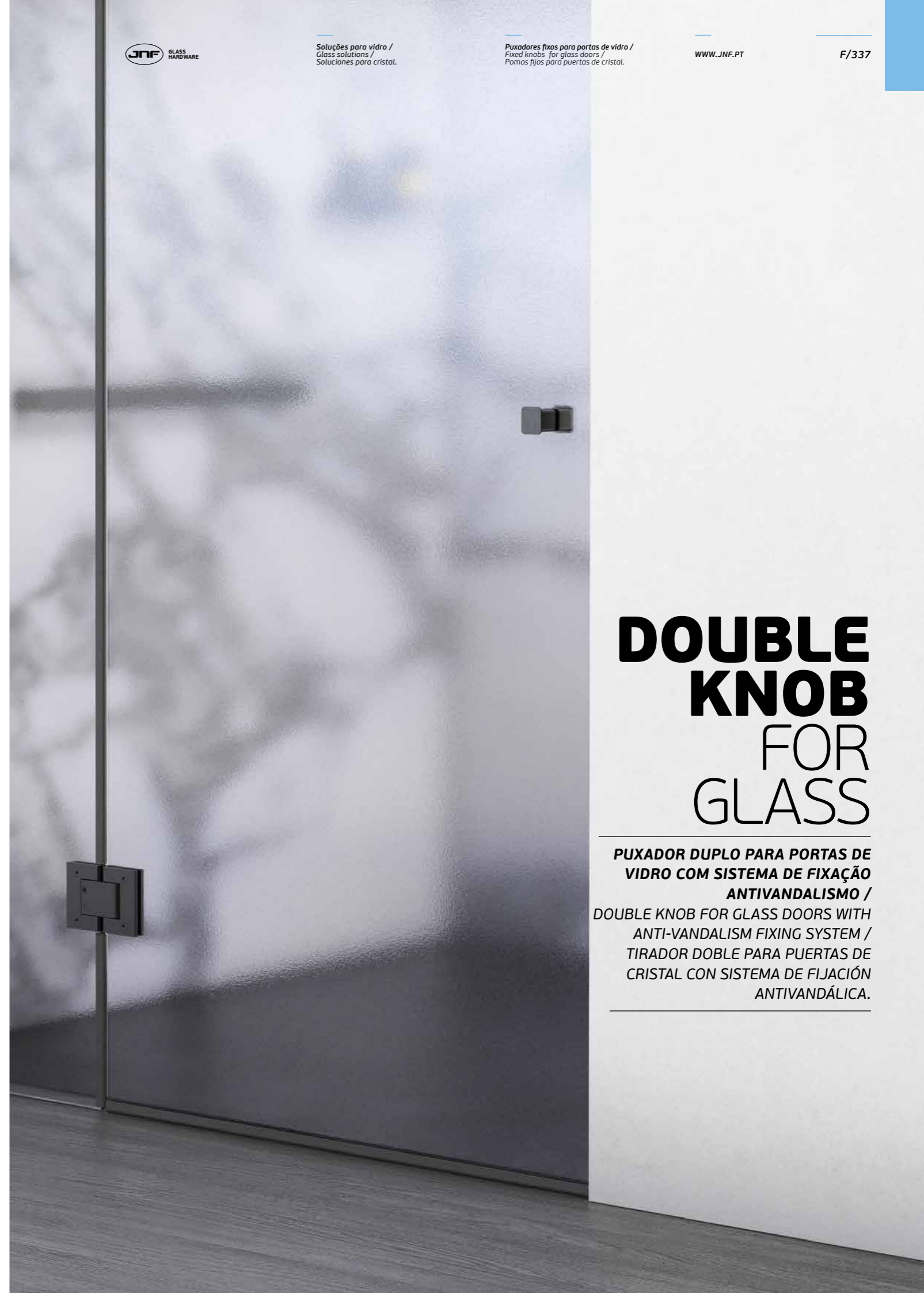

PUXADORES PARA PORTAS DE VIDRO / KNOBS FOR GLASS DOORS / POMOS PARA PUERTAS DE CRISTAL.

IN.75.050.D

Puxador de porta duplo anti-vandalismo / Double door knob with anti-vandalism fixing / Tirador de puerta doble anti-vandalismo.

.TB .TG .TCO .TCH

MATERIAL: EN 1.4301 / AISI 304

ACABAMENTO / FINISH / ACABADO: STANDARD: SATINADO / SATIN / SATIN

OPTIONAL: PVD TITANIUM COATED

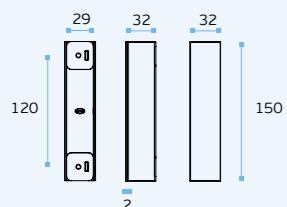

IN.75.050.D.TB
pvd titanium black



IN.75.050.D.TG
pvd titanium gold



IN.75.050.D.TCO
pvd titanium copper



IN.75.050.D.TCH
pvd titanium chocolate

IN.75.051.D

Puxador de porta duplo anti-vandalismo / Double door knob with anti-vandalism fixing / Tirador de puerta doble anti-vandalismo.

.TB .TG .TCO .TCH

MATERIAL: EN 1.4301 / AISI 304

ACABAMENTO / FINISH / ACABADO: STANDARD: SATINADO / SATIN / SATIN

OPTIONAL: PVD TITANIUM COATED

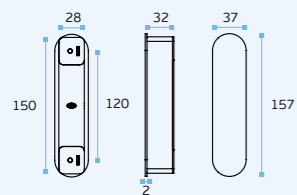

IN.75.051.D.TB
pvd titanium black



IN.75.051.D.TG
pvd titanium gold



IN.75.051.D.TCO
pvd titanium copper



IN.75.051.D.TCH
pvd titanium chocolate

DOUBLE KNOB FOR GLASS

PUXADOR DUPLO PARA PORTAS DE VIDRO COM SISTEMA DE FIXAÇÃO ANTIVANDALISMO
DOUBLE KNOB FOR GLASS DOORS WITH ANTI-VANDALISM FIXING SYSTEM / TIRADOR DOBLE PARA PUERTAS DE CRISTAL CON SISTEMA DE FIJACIÓN ANTIVANDÁLICA.



PUXADORES FIXOS PARA PORTAS DE VIDRO / FIXED DOOR KNOBS FOR GLASS DOORS / POMO FIJO PARA PUERTAS DE CRISTAL.

IN.00.165.D

Puxador fixo duplo /
Double fixed knob /
Pomo fijo doble.

.TB **.TG** **.TCO** **.TCH**

MATERIAL: EN 1.4301 / AISI 304

ACABAMENTO / FINISH / ACABADO:
STANDARD: SATINADO / SATIN / SATIN

OPTIONAL: PVD TITANIUM COATED

.TB / .TG / .TCO / .TCH

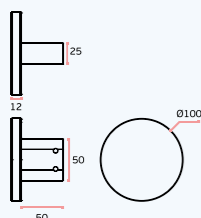

SOLID ■

ACESSÓRIOS / ACCESSORIES

MFU M6 --- INCLUDED

IN.00.165.D PREPARADA PARA VIDRO /
IN.00.165.D READY FOR GLASS



IN.00.165.D.TB
 Titanium Black



IN.00.165.D.TG
 Titanium Gold



IN.00.165.D.TCO
 Titanium Copper



IN.00.165.D.TCH
 Titanium Chocolate

IN.00.168

Puxador fixo /
Fixed knob / Pomo fijo.

IN.00.168.D

Puxador fixo duplo /
Double fixed knob / Pomo fijo doble.
Design: Christian Magalhães

.TB **.TG** **.TCO** **.TCH**

MATERIAL: EN 1.4301 / AISI 304

ACABAMENTO / FINISH / ACABADO:
STANDARD: SATINADO / SATIN / SATIN

OPTIONAL: PVD TITANIUM COATED

.TB / .TG / .TCO / .TCH

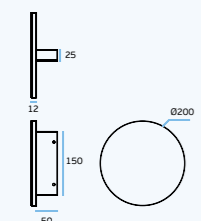

SOLID ■

ACESSÓRIOS / ACCESSORIES

MFU M6 --- INCLUDED

PREPARADA PARA VIDRO /
READY FOR GLASS



SOLID STAINLESS STEEL KNOBS

**A PRECISÃO DOS CENTROS CNC,
 PERMITE-NOS ESCULPIR ESTES
 PUXADORES IMPRESSIONANTES E DE
 FORMAS PERFEITAS /**

**THE PRECISION OF CNC MACHINERY
 ALLOW US TO CREATE THIS IMPRESSIVE
 AND PERFECT SHAPED KNOBS
 FIXED DOOR KNOB DESIGNED WITH
 ERGONOMICS IN MIND /**

**LA PRECISIÓN DE LA MAQUINARIA CNC
 NOS PERMITE CREAR ESTOS POMOS
 IMPRESSIONANTES Y DE FORMA PERFECTA.**

PUXADORES FIXOS PARA PORTAS DE VIDRO / FIXED DOOR KNOBS FOR GLASS DOORS / POMO FIJO PARA PUERTAS DE CRISTAL.

IN.00.166

Puxador fixo/ Fixed knob / Pomo fijo.

IN.00.166.D

Puxador fixo duplo/ Double fixed knob / Pomo fijo doble.

Design: Christian Magalhães



MATERIAL: EN 1.4301 / AISI 304

ACABAMENTO / FINISH / ACABADO:
STANDARD: SATINADO / SATIN / SATIN

OPTIONAL: PVD TITANIUM COATED

.TB / .TG / .TCO / .TCH

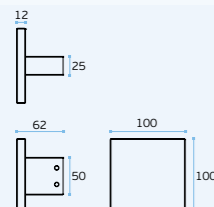

SOLID ■

ACESSÓRIOS / ACCESSORIES

MFU M6 --- INCLUDED

PREPARADA PARA VIDRO /
READY FOR GLASS



IN.00.167

Puxador fixo/ Fixed knob / Pomo fijo.

IN.00.167.D

Puxador fixo duplo/ Double fixed knob / Pomo fijo doble.

Design: Christian Magalhães



MATERIAL: EN 1.4301 / AISI 304

ACABAMENTO / FINISH / ACABADO:
STANDARD: SATINADO / SATIN / SATIN

OPTIONAL: PVD TITANIUM COATED

.TB / .TG / .TCO / .TCH

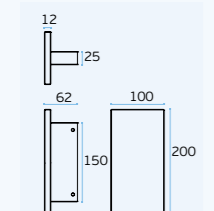

SOLID ■

ACESSÓRIOS / ACCESSORIES

MFU M6 --- INCLUDED

PREPARADA PARA VIDRO /
READY FOR GLASS



.P
Polido
Mirror polished
Pulido

.TB
PVD
Titanium
black

.TG
PVD
Titanium
gold

.TCO
PVD
Titanium
copper

.TCH
PVD
Titanium
chocolate

.P
Polido
Mirror polished
Pulido

.TB
PVD
Titanium
black

.TG
PVD
Titanium
gold

.TCO
PVD
Titanium
copper

.TCH
PVD
Titanium
chocolate

IN.00.169

Puxador fixo/ Fixed knob / Pomo fijo.

IN.00.169.D

Puxador fixo duplo/ Double fixed knob / Pomo fijo doble.

Design: Christian Magalhães



MATERIAL: EN 1.4301 / AISI 304

ACABAMENTO / FINISH / ACABADO:
STANDARD: SATINADO / SATIN / SATIN

OPTIONAL: PVD TITANIUM COATED

.TB / .TG / .TCO / .TCH

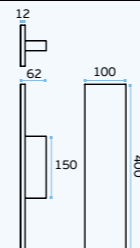

SOLID ■

ACESSÓRIOS / ACCESSORIES

MFU M6 --- INCLUDED

PREPARADA PARA VIDRO /
READY FOR GLASS



IN.00.169.TB
Titanium Black

IN.00.169.TG
Titanium Gold

IN.00.169.TCO
Titanium Copper

IN.00.169.TCH
Titanium Chocolate

PUXADORES FIXOS PARA PORTAS DE VIDRO / FIXED DOOR KNOBS FOR GLASS DOORS / POMO FIJO PARA PUERTAS DE CRISTAL.



GATE SERIES

COLEÇÃO DE PUXADORES FIXOS GATE, PRODUZIDOS EM AÇO INOXIDÁVEL, ESTES PUXADORES, GARANTEM UM TOQUE ERGONÔMICO. PROJETADOS PARA ALCANÇAR O EQUILÍBRIO PERFEITO ENTRE DESIGN E FUNCIONALIDADE, A BASE É PARTILHADA COM TODOS OS MODELOS E ALGUNS COMPONENTES SÃO PRODUZIDOS EM MATERIAIS POLIMÉRICOS, QUE GARANTEM UM SISTEMA DE FIXAÇÃO FORTE E ESTÁVEL.

O CORPO ROBUSTO É PRODUZIDO POR TECNOLOGIA AVANÇADA SEM CONSUMIR MATÉRIAS-PRIMAS DESNECESSÁRIAS.

OS ACABAMENTOS DISPONÍVEIS SÃO AÇO INOXIDÁVEL SATINADO E PVD TITÂNIO PRETO, DOURADO, COBRE E CHOCOLATE.

GATE A COLLECTION OF FIXED DOOR KNOBS MADE IN STAINLESS STEEL, THESE KNOBS HAVE AN ERGONOMIC TOUCH. DESIGNED TO ARCHIVE THE PERFECT COMPROMISE BETWEEN A TRENDY LOOK AND FUNCTIONALITY, THE BASE IS SHARED WITH ALL MODELS, AND INCLUDE POLYMERIC MATERIALS, THAT CREATE A STRONG AND STABLE FIXING SYSTEM.

THE ROBUST BODY IS PRODUCED BY ADVANCED TECHNOLOGY WITHOUT SPENDING UNNECESSARY RAW MATERIAL.

THE AVAILABLE FINISHES ARE SATIN STAINLESS STEEL, AND PVD TITANIUM BLACK, GOLD, COPPER AND CHOCOLATE.

GATE UNA COLECCIÓN DE POMOS DE PUERTA FIJOS FABRICADOS EN ACERO INOXIDABLE, ESTOS POMOS TIENEN UN TOQUE ERGONÓMICO. DISEÑADOS PARA LOGRAR EL EQUILIBRIO PERFECTO ENTRE DISEÑO Y FUNCIONALIDAD, LA BASE SE COMPARTIENE CON TODOS LOS MODELOS, INCLUIDOS MATERIALES POLIMÉRICOS, QUE GARANTIZAN UN SISTEMA DE SUJECIÓN FUERTE Y ESTABLE.

EL CUERPO ROBUSTO SE PRODUCE MEDIANTE TECNOLOGÍA AVANZADA SIN CONSUMIR MATERIAS PRIMAS INNECESARIAS.

LOS ACABADOS DISPONIBLES SON ACERO INOXIDABLE SATINADO Y PVD TITANIO NEGRO, DOURADO, COBRE Y CHOCOLATE.

NEW



IN.00.115.R.200 GATE
Puxador de porta fixo /
Fixed door knob / Pomo de puerta fijo.



MATERIAL: EN 1.4301 / AISI 304

ACABAMENTO / FINISH / ACABADO: STANDARD:
SATINADO / SATIN / SATIN

OPTIONAL: PVD TITANIUM COATED

.TB / .TG / .TCO / .TCH

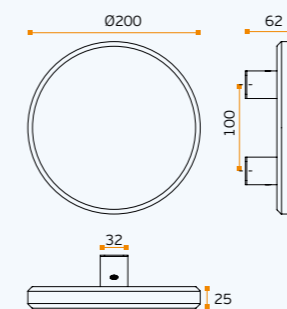

NEW



IN.00.115.R.70 GATE
Puxador de porta fixo /
Fixed door knob / Pomo de puerta fijo.



IN.00.115.R.100 GATE
Puxador de porta fixo /
Fixed door knob / Pomo de puerta fijo.



MATERIAL: EN 1.4301 / AISI 304

ACABAMENTO / FINISH / ACABADO: STANDARD:
SATINADO / SATIN / SATIN

OPTIONAL: PVD TITANIUM COATED

.TB / .TG / .TCO / .TCH

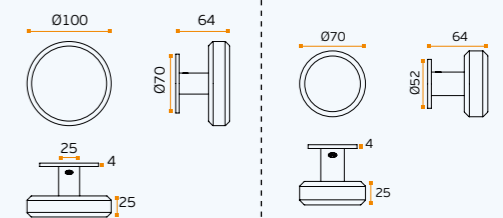

IN.00.115.R.100

IN.00.115.R.70

PUXADORES FIXOS PARA PORTAS DE VIDRO / FIXED DOOR KNOBS FOR GLASS DOORS / POMO FIJO PARA PUERTAS DE CRISTAL.

NEW



IN.00.115.250 GATE

Puxador de porta fixo /
Fixed door knob / Pomo de puerta fijo.



MATERIAL: EN 1.4301 / AISI 304

ACABAMENTO / FINISH / ACABADO: STANDARD:
SATINADO / SATIN / SATIN

OPTIONAL: PVD TITANIUM COATED

.TB / .TG / .TCO / .TCH

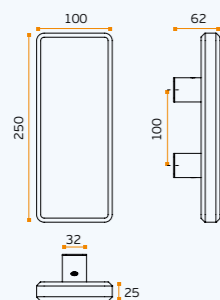

NEW



IN.00.115.100 GATE

Puxador de porta fixo /
Fixed door knob / Pomo de puerta fijo.



MATERIAL: EN 1.4301 / AISI 304

ACABAMENTO / FINISH / ACABADO: STANDARD:
SATINADO / SATIN / SATIN

OPTIONAL: PVD TITANIUM COATED

.TB / .TG / .TCO / .TCH

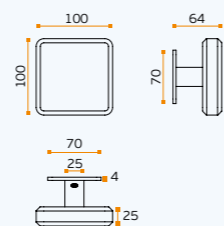

NEW



IN.00.115.70 GATE

Puxador de porta fixo /
Fixed door knob / Pomo de puerta fijo.



MATERIAL: EN 1.4301 / AISI 304

ACABAMENTO / FINISH / ACABADO: STANDARD:
SATINADO / SATIN / SATIN

OPTIONAL: PVD TITANIUM COATED

.TB / .TG / .TCO / .TCH

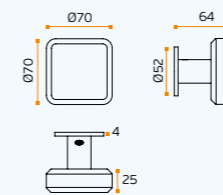

NEW

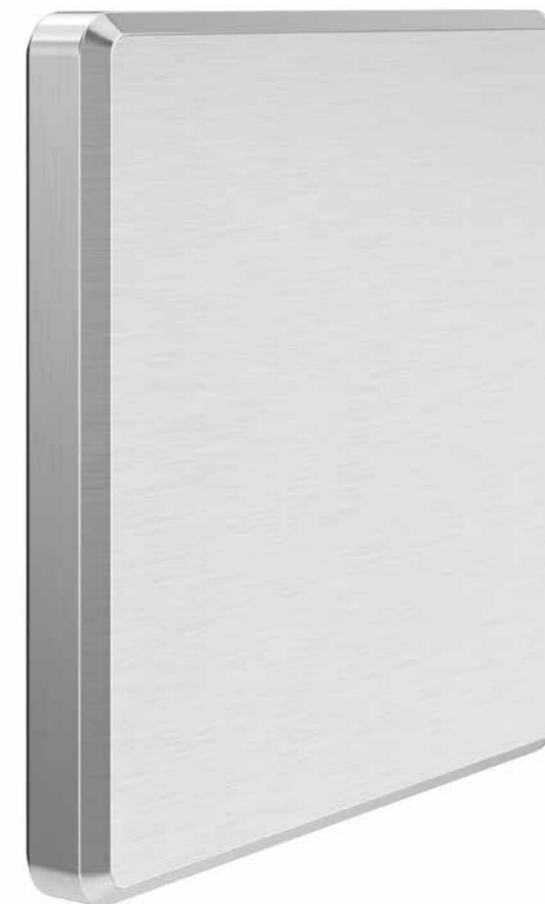

IN.00.115.200 GATE

Puxador de porta fixo /
Fixed door knob / Pomo de puerta fijo.



MATERIAL: EN 1.4301 / AISI 304

ACABAMENTO / FINISH / ACABADO: STANDARD:
SATINADO / SATIN / SATIN

OPTIONAL: PVD TITANIUM COATED

.TB / .TG / .TCO / .TCH

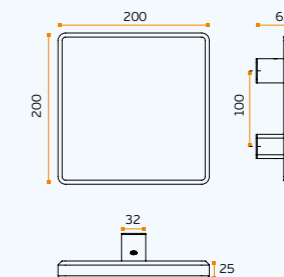

PUXADORES / TOALHEIROS PARA PORTAS DE VIDRO / HANDLES / TOWEL RACKS FOR GLASS DOORS / MANILLAS / TOALLEROS PARA PUERTAS DE CRISTAL /

IN.44.175.425.TVK QUADRO

Kit de toalheiros e puxador para portas de chuveiros /

Set for towel bar and knob for shower glass cabinet /
Juego de toallero y pomo para puertas de ducha.

MATERIAL: EN 1.4301 / AISI 304

ACABAMENTO / FINISH / ACABADO:

SATINADO / SATIN / SATIN

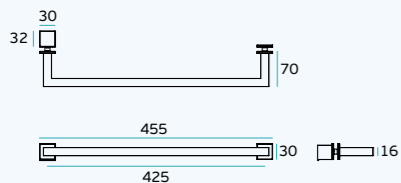

IN.53.400.425.TVK BONJOUR!

Kit de toalheiros e puxador para portas de chuveiros /

Set for towel bar and knob for shower glass cabinet /
Juego de toallero y pomo para puertas de ducha.

MATERIAL: EN 1.4301 / AISI 304

ACABAMENTO / FINISH / ACABADO: STANDARD:
SATINADO / SATIN / SATIN

OPTIONAL: PVD TITANIUM COATED

.TB / .TG / .TCO

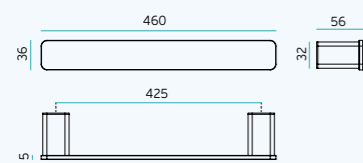

IN.52.400.425.TVK.TB
PVD Titanium Black



IN.52.400.425.TVK.TG
PVD Titanium Gold



IN.52.400.425.TVK.TCO
PVD Titanium Copper

SHOWER GLASS DOOR TOWEL BAR / KNOB

A SOLUÇÃO PERFEITA PARA
COMBINAR COM OS ACESSÓRIOS DE
CASA DE BANHO /
THE PERFECT SOLUTION TO MATCH
THE BATHROOM ACCESSORIES /
LA SOLUCIÓN PERFECTA PARA COMBINAR
CON LOS ACCESORIOS DEL BAÑO.



PUXADORES / TOALHEIROS PARA PORTAS DE VIDRO / HANDLES / TOWEL RACKS FOR GLASS DOORS / MANILLAS / TOALLEROS PARA PUERTAS DE CRISTAL /

IN.43.150.M.425.TVK FINE

Kit de toalheiros e puxador para portas de chuveiros /
Set for towel bar and knob for shower glass cabinet /
Juego de toallero y pomo para puertas de ducha.

MATERIAL: EN 1.4301 / AISI 304

ACABAMENTO / FINISH / ACABADO:

SATINADO / SATIN / SATIN

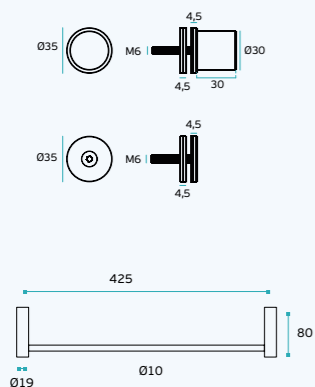

MR.46.001.425.TVK MERIDIAN

Kit de toalheiros e puxador para portas de chuveiros /
Set for towel bar and knob for shower glass cabinet /
Juego de toallero y pomo para puertas de ducha.

MATERIAL: EN 1.4301 / AISI 304

ACABAMENTO / FINISH / ACABADO:

SATINADO / SATIN / SATIN

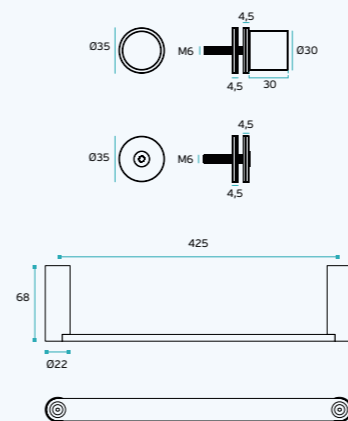

IN.52.304.425.TVK BRANCH

Kit de toalheiros e puxador para portas de chuveiros /
Set for towel bar and knob for shower glass cabinet /
Juego de toallero y pomo para puertas de ducha.

.TB .TG .TCO

MATERIAL: EN 1.4301 / AISI 304

ACABAMENTO / FINISH / ACABADO: STANDARD:

SATINADO / SATIN / SATIN

OPTIONAL: PVD TITANIUM COATED

.TB / .TG / .TCO

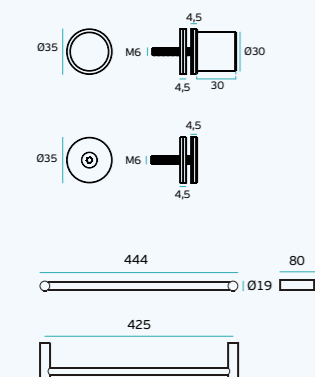

IN.52.304.425.TVK.TB
PVD Titanium Black

IN.52.304.425.TVK.TG
PVD Titanium Gold

IN.52.304.425.TVK.TCO
PVD Titanium Copper

IN.53.200.425.TVK NATUR

Kit de toalheiros e puxador para portas de chuveiros /
Set for towel bar and knob for shower glass cabinet /
Juego de toallero y pomo para puertas de ducha.

.TB .TG .TCO

MATERIAL: EN 1.4301 / AISI 304

ACABAMENTO / FINISH / ACABADO: STANDARD:

SATINADO / SATIN / SATIN

OPTIONAL: PVD TITANIUM COATED

.TB / .TG / .TCO

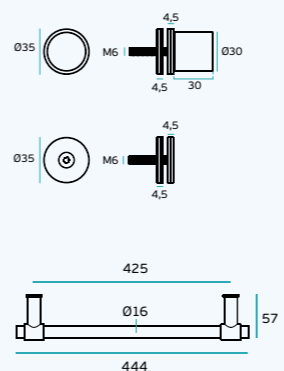

IN.53.200.425.TVK.TB
PVD Titanium Black

IN.53.200.425.TVK.TG
PVD Titanium Gold

IN.53.200.425.TVK.TCO
PVD Titanium Copper

PUXADORES / TOALHEIROS PARA PORTAS DE VIDRO / HANDLES / TOWEL RACKS FOR GLASS DOORS / MANILLAS / TOALLEROS PARA PUERTAS DE CRISTAL /

IN.41.141.19.425.TVK TONDA

Kit de toalheiros e puxador para portas de chuveiros /
 Set for towel bar and knob for shower glass cabinet /
 Juego de toallero y pomo para puertas de ducha.

MATERIAL: EN 1.4301 / AISI 304

ACABAMENTO / FINISH / ACABADO:

SATINADO / SATIN / SATIN

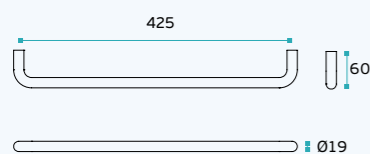
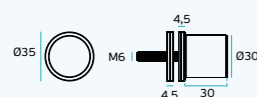

IN.42.145.19.425.TVK ÂNGULO

Kit de toalheiros e puxador para portas de chuveiros /
 Set for towel bar and knob for shower glass cabinet /
 Juego de toallero y pomo para puertas de ducha.

.TB

MATERIAL: EN 1.4301 / AISI 304

ACABAMENTO / FINISH / ACABADO: STANDARD:

SATINADO / SATIN / SATIN

OPTIONAL: PVD TITANIUM BLACK (.TB)

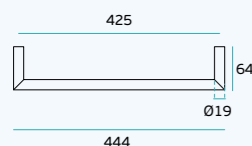
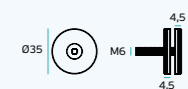

IN.42.145.19.425.TVK.TB
 PVD Titanium Black

TOWEL BAR / KNOB

A PORTA DE VIDRO DO CHUVEIRO PODE TER O MESMO MODELO DE TOALHEIRO QUE A RESTANTE CASA DE BANHO, SIMULTANEAMENTE O CHUVEIRO TEM UM PUXADOR NO INTERIOR E PARA ABRIR PELO EXTERIOR O TOALHEIRO TEM FUNÇÃO DUPLA, FUNCIONANDO COMO ASA DE PORTA /
 THE GLASS DOOR OF THE SHOWER CAN HAVE THE SAME TOWEL BAR AS THE REMAINING BATHROOM, SIMULTANEOUSLY THE SHOWER HAVE ONE KNOB FOR INSIDE AND TO OPEN FROM OUTSIDE THE TOWEL BAR GETS DOUBLE FUNCTION NOW WORKING AS PULL HANDLE /
 LA PUERTA DE CRISTAL DE LA DUCHA PUEDE TENER EL MISMO MODELO DE TOALLERO QUE EL RESTO DEL BAÑO, SIMULTÁNEAMENTE LA DUCHA TIENE UN POMO EN EL INTERIOR Y PARA ABRIR POR FUERA EL TOALLERO TIENE DOBLE FUNCIÓN, FUNCIONANDO COMO MANILLONE DE PUERTA.

ASAS PARA PORTAS DE VIDRO / PULL HANDLES FOR GLASS DOORS / MANILLONES PARA PUERTAS DE CRISTAL.

SLIM SQUARE

DESENHADO POR PEDRO QUEIRÓS,
ESTA COLEÇÃO FOI INSPIRADA
NA SIMPLICIDADE DAS FORMAS
GEOMÉTRICAS. AS FORMAS
GEOMÉTRICAS TÊM O PODER DE CRIAR
DESIGNS INSPIRADORES QUE PODEM
DE ALGUMA FORMA TRANSFORMAR O
ESPAÇO EM QUE ESTÃO INSERIDAS.

DESIGNED BY PEDRO QUEIRÓS, THIS
COLLECTION WAS INSPIRED BY THE
SIMPLICITY OF GEOMETRIC SHAPES.
GEOMETRIC SHAPES HAVE THE POWER
TO CREATE INSPIRING DESIGNS THAT CAN
SOMEHOW TRANSFORM THE SPACE IN
WHICH THEY ARE INSERTED.

DISEÑADA POR PEDRO QUEIRÓS, ESTA
COLECCIÓN SE INSPIRÓ EN LA SENCILLEZ
DE LAS FORMAS GEOMÉTRICAS.
LAS FORMAS GEOMÉTRICAS TIENEN EL
PODER DE CREAR DISEÑOS INSPIRADORES
QUE DE ALGUNA MANERA PUEDEN
TRANSFORMAR EL ESPACIO EN
EL QUE SE INSERTAN.



IN.07.432.D
SLIM SQUARE
Asa de porta dupla /
Double door handle /
Manillon de puerta doble.

+
IN.08.GSL
Acessório para asa
de porta de vidro /
Accessory for glass door handle /
Accesorio para manillon
de puerta de cristal.

.P
Polido
Mirror polished
Pulido

.TB
PVD
Titanium
black

.TG
PVD
Titanium
gold

.TCO
PVD
Titanium
copper

.TCH
PVD
Titanium
chocolate

.TB **.TG** **.TCO** **.TCH**

MATERIAL: EN 1.4301 / AISI 304

ACABAMENTO / FINISH / ACABADO:
STANDARD: SATINADO / SATIN / SATIN

OPTIONAL: PVD TITANIUM COATED

.TB / .TG / .TCO / .TCH

DESIGN: PEDRO QUEIRÓS

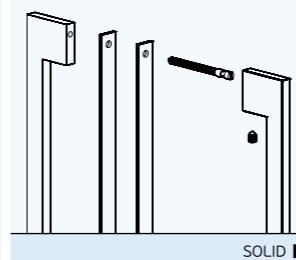
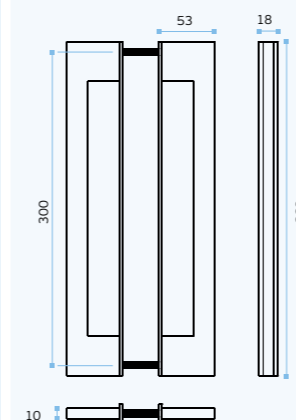

IN.07.432.S
SLIM SQUARE
Asa de porta simples /
Single door handle /
Manillon de puerta sencilla.

+
IN.08.GSL
Acessório para asa
de porta de vidro /
Accessory for glass door handle /
Accesorio para manillon
de puerta de cristal.

.TB **.TG** **.TCO** **.TCH**

MATERIAL: EN 1.4301 / AISI 304

ACABAMENTO / FINISH / ACABADO:
STANDARD: SATINADO / SATIN / SATIN

OPTIONAL: PVD TITANIUM COATED

.TB / .TG / .TCO / .TCH

DESIGN: PEDRO QUEIRÓS

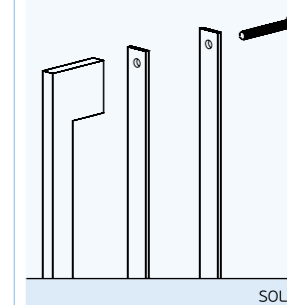
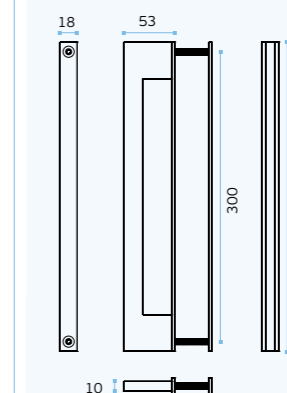

ASAS PARA PORTAS DE VIDRO / PULL HANDLES FOR GLASS DOORS / MANILLONES PARA PUERTAS DE CRISTAL.

NEW

IN.07.532.S
SLIM ROUNDED
Asa de porta simples / Simple door handle / Manillon de puerta simple.
+ IN.08.GSL
Accessório para asa de porta simples para vidro / Accessory for single glass door handle / Accesorio para manillon de puerta simple para cristal.

.TB .TG .TCO .TCH

MATERIAL: EN 1.4301 / AISI 304
ACABAMENTO / FINISH / ACABADO: STANDARD: SATINADO / SATIN / SATIN
OPTIONAL: PVD TITANIUM COATED
.TB / .TG / .TCO / .TCH
DESIGN: PEDRO QUEIRÓS

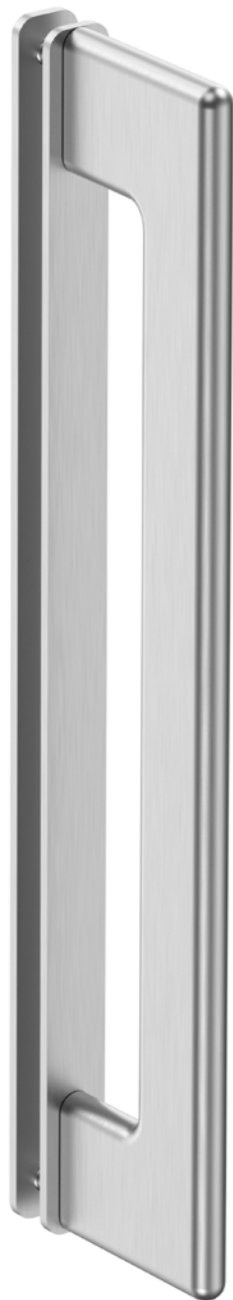
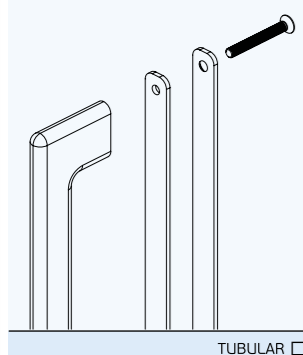
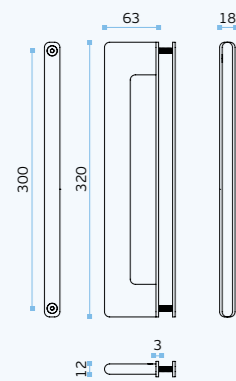

IN.07.532.S.TB
Titanium Black

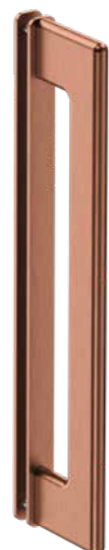

IN.07.532.S.TCO
Titanium Copper



IN.07.532.S.TG
Titanium Gold



IN.07.532.S.TCH
Titanium Chocolate

.P
 Polido
 Mirror polished
 Pulido

.TB
 PVD
 Titanium
 black

.TG
 PVD
 Titanium
 gold

.TCO
 PVD
 Titanium
 copper

.TCH
 PVD
 Titanium
 chocolate

.P
 Polido
 Mirror polished
 Pulido

.TB
 PVD
 Titanium
 black

.TG
 PVD
 Titanium
 gold

.TCO
 PVD
 Titanium
 copper

.TCH
 PVD
 Titanium
 chocolate

NEW

IN.07.532.S
SLIM ROUNDED
Asa de porta dupla / Double door handle / Manillon de puerta doble.
+ IN.08.GSL
Accessório para asa de porta dupla de vidro / Accessory for double glass door handle / Accesorio para manillon de puerta doble de cristal.

.TB .TG .TCO .TCH

MATERIAL: EN 1.4301 / AISI 304
ACABAMENTO / FINISH / ACABADO: STANDARD: SATINADO / SATIN / SATIN
OPTIONAL: PVD TITANIUM COATED
.TB / .TG / .TCO / .TCH
DESIGN: PEDRO QUEIRÓS

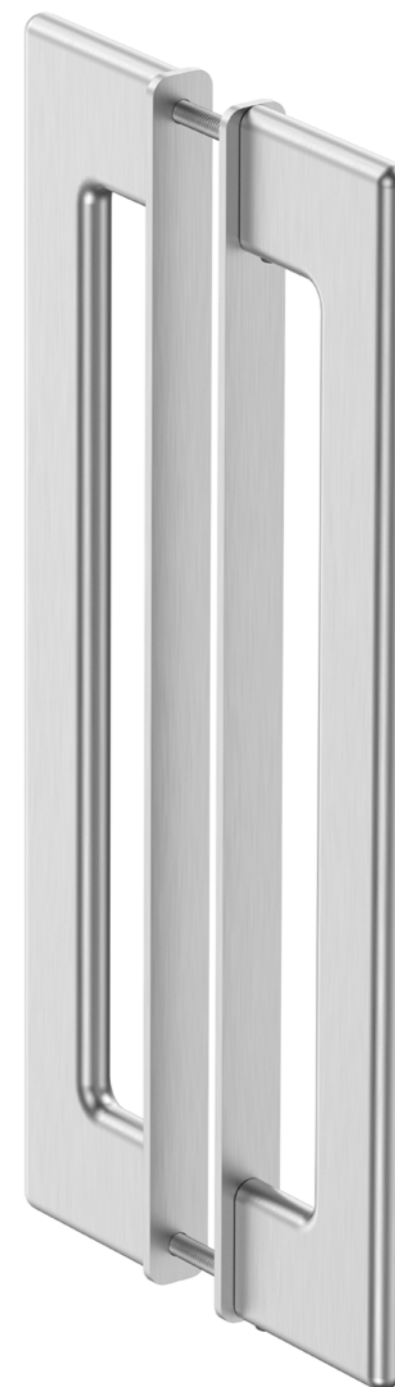
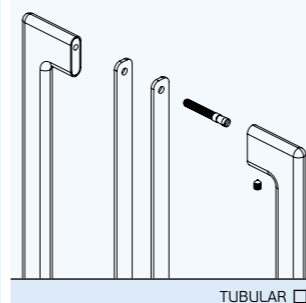
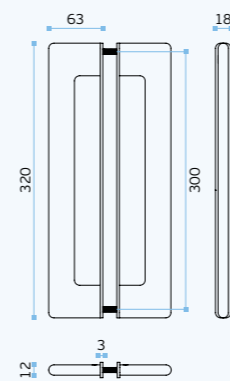

IN.07.532.D.TB
Titanium Black



IN.07.532.D.TG
Titanium Gold

ASAS PARA PORTAS DE VIDRO / PULL HANDLES FOR GLASS DOORS / MANILLONES PARA PUERTAS DE CRISTAL.

IN.07.201.V.600

Asas para portas de correr em
vidro / Pull handles for glass sliding
doors / Manillones para puertas
correderas de cristal.



MATERIAL: EN 1.4301 / AISI 304

ACABAMENTO / FINISH / ACABADO:
STANDARD: SATINADO / SATIN / SATIN

OPTIONAL: PVD TITANIUM COATED

.TB / .TG / .TCO / .TCH

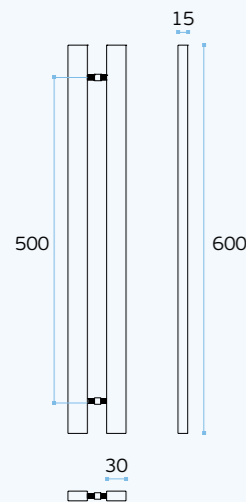

TUBULAR

PARA VIDRO / FOR GLASS / PARA CRISTAL



IN.07.201.V.1200 (*)

Asas para portas de correr em
vidro / Pull handles for glass sliding
doors / Manillones para puertas
correderas de cristal.

MATERIAL: EN 1.4301 / AISI 304

ACABAMENTO / FINISH / ACABADO:
STANDARD: SATINADO / SATIN / SATIN

OPTIONAL: PVD TITANIUM COATED

.TB / .TG / .TCO / .TCH

(*) Acabamento em PVD titânio até 1000mm
/ PVD titanium finish until 1000mm / Acabado en
PVD titânio hasta 1000mm.

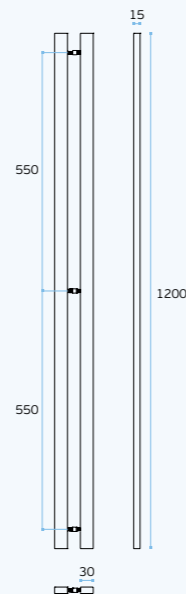

TUBULAR

PARA VIDRO / FOR GLASS / PARA CRISTAL



.P
Polido
Mirror polished
Pulido

.TB
PVD
Titanium
black

.TG
PVD
Titanium
gold

.TCO
PVD
Titanium
copper

.TCH
PVD
Titanium
chocolate

SLIDING DOOR LEVER HANDLE

PARTINDO DE UMA BASE RETANGULAR
DESENVOLVEMOS ESTE PUXADOR
ESPECIALMENTE PARA PORTAS DE
CORRER. A SEÇÃO 15X30mm
FOI DIMENSIONADA PARA OBTEN-
UM PERFEITO FUNCIONAMENTO /
WE USE A RECTANGULAR BASE
TO DEVELOP THIS PULL HANDLE
ESPECIALLY FOR SLIDING DOORS .
THE SECTION 15X30mm GIVE THE
NECESSARY HANDLING /
PARTIENDO DE UNA BASE RECTANGULAR,
DESARROLLAMOS ESTE MANILLONE
ESPECIALMENTE PARA PUERTAS
CORREDERAS. LA SECCIÓN DE 15X30 mm
FUE DIMENSIONADO PARA OBTENER UN
PERFECTO FUNCIONAMIENTO.

ASAS PARA PORTAS DE VIDRO / PULL HANDLES FOR GLASS DOORS / MANILLONES PARA PUERTAS DE CRISTAL.

IN.07.177.D TOKYO

Asa de porta dupla para vidro /
 Double door handle for glass /
 Manillon de puerta doble para cristal.

+ IN.08.MFU.DV.22

Accesório para asa de porta dupla
 para vidro / Accessory for double
 glass door handle / Accesorio para
 manillon de puerta doble de cristal.

.TB .TG .TCO .TCH

MATERIAL: EN 1.4301 / AISI 304

ACABAMENTO / FINISH / ACABADO:
 SATINADO / SATIN / SATIN

OPTIONAL: PVD TITANIUM COATED

.TB / .TG / .TCO / .TCH

DESIGN: CHRISTIAN MAGALHÃES

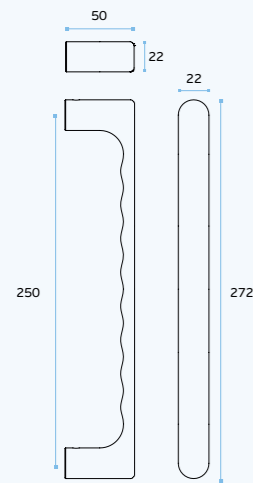

IN.07.178.D KYOTO

Asa de porta dupla para vidro /
 Double door handle for glass /
 Manillon de puerta doble para cristal.

+ IN.08.MFU.DVQ.25

Accesório para asa de porta dupla
 para vidro / Accessory for double
 glass door handle / Accesorio para
 manillon de puerta doble de cristal

.TB .TG .TCO .TCH

MATERIAL: EN 1.4301 / AISI 304

ACABAMENTO / FINISH / ACABADO:
 SATINADO / SATIN / SATIN

OPTIONAL: PVD TITANIUM COATED

.TB / .TG / .TCO / .TCH

DESIGN: CHRISTIAN MAGALHÃES

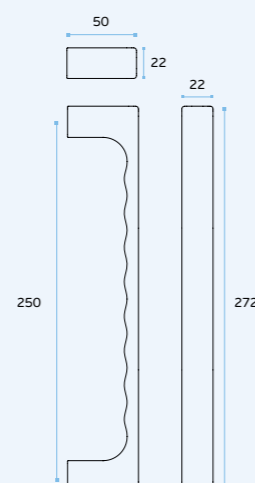

.P
 Polido
 Mirror polished
 Pulido

.TB
 PVD
 Titanium
 black

.TG
 PVD
 Titanium
 gold

.TCO
 PVD
 Titanium
 copper

.TCH
 PVD
 Titanium
 chocolate

ERGO
 COMFORT

IN.08.MFU.SV.22

Accesório para asa de porta simples para vidro
 Accessory for single glass door handle /
 Accesorio para manillon de puerta simple para
 cristal.

SOLID ■

ERGO
 COMFORT

IN.08.MFU.SVQ.25

Accesório para asa de porta simples para vidro
 Accessory for single glass door handle /
 Accesorio para manillon de puerta simple para
 cristal.

SOLID ■

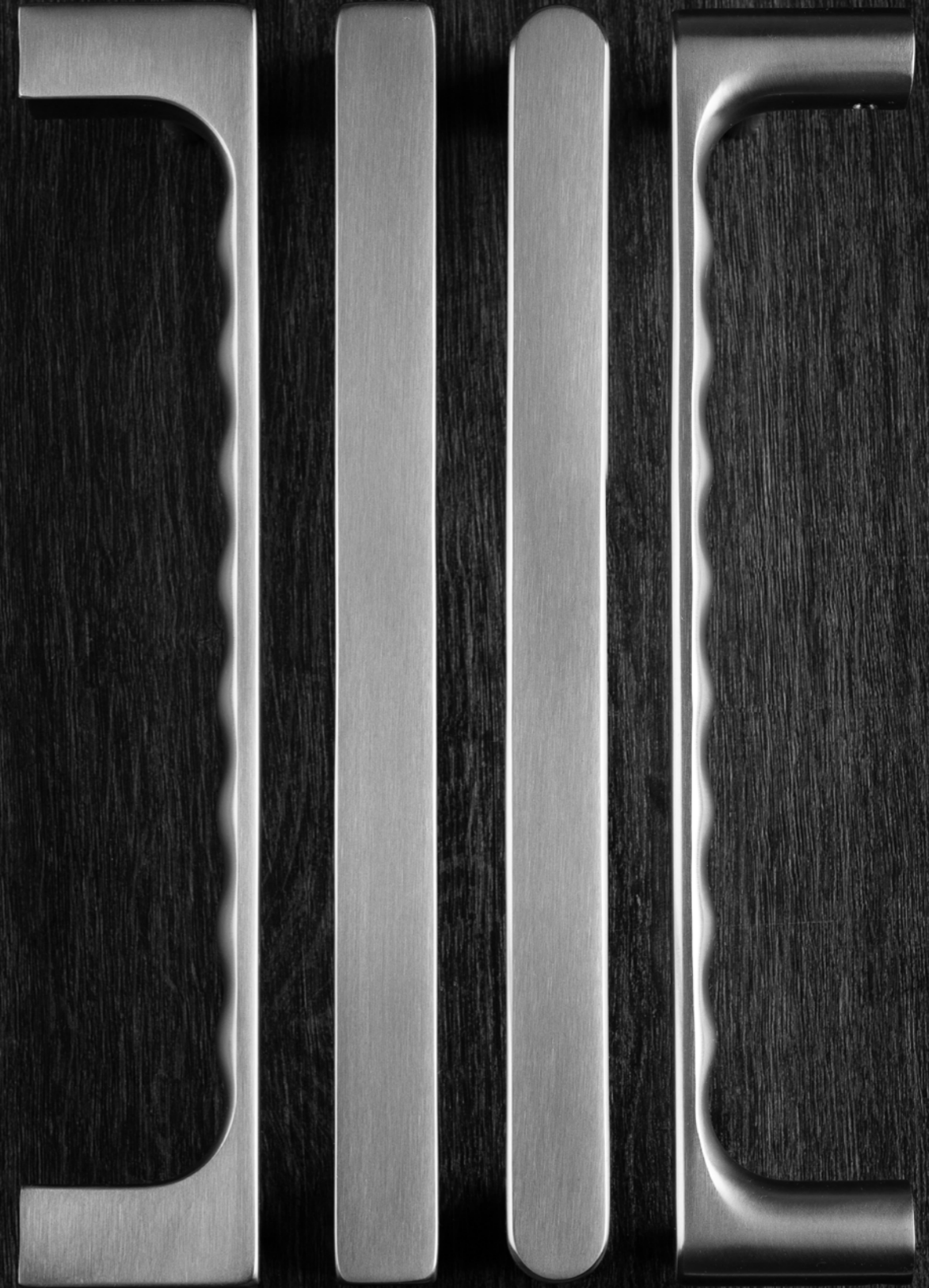

ASAS PARA PORTAS DE VIDRO / PULL HANDLES FOR GLASS DOORS / MANILLONES PARA PUERTAS DE CRISTAL.

IN.07.002.D METRIC
Asa de porta dupla para vidro / Double door handle for glass / Manillon de puerta doble para cristal.

IN.08.MFU.DVO.002
Acessório para asa de porta dupla para vidro / Accessory for double glass door handle / Accesorio para manillon de puerta doble de cristal



MATERIAL: EN 1.4301 / AISI 304

ACABAMENTO / FINISH / ACABADO: SATINADO / SATIN / SATIN

OPTIONAL: POLIDO/POLISHED/PULIDO

.P

OPTIONAL: PVD TITANIUM COATED

.TB / .TG / .TCO / .TCH

DESIGN: MIGUEL VASCONCELOS



IN.07.179.D YOKOHAMA
Asa de porta dupla para vidro / Double door handle for glass / Manillon de puerta doble para cristal.

IN.08.MFU.DV.25
Acessório para asa de porta dupla para vidro / Accessory for double glass door handle / Accesorio para manillon de puerta doble de cristal



MATERIAL: EN 1.4301 / AISI 304

ACABAMENTO / FINISH / ACABADO: SATINADO / SATIN / SATIN

OPTIONAL: PVD TITANIUM COATED

.TB / .TG / .TCO / .TCH

DESIGN: CHRISTIAN MAGALHÃES

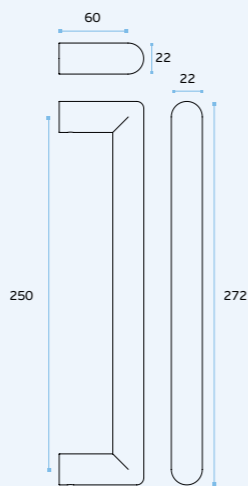

.P
Polido
Mirror polished
Pulido

.TB
PVD
Titanium
black

.TG
PVD
Titanium
gold

.TCO
PVD
Titanium
copper

.TCH
PVD
Titanium
chocolate

.P
Polido
Mirror polished
Pulido

.TB
PVD
Titanium
black

.TG
PVD
Titanium
gold

.TCO
PVD
Titanium
copper

.TCH
PVD
Titanium
chocolate

IN.07.031.D
Asa de porta dupla para vidro / Double door handle for glass / Manillon de puerta doble para cristal.

IN.08.MFU.DV.25
Acessório para asa de porta dupla para vidro / Accessory for double glass door handle / Accesorio para manillon de puerta doble de cristal.



MATERIAL: EN 1.4301 / AISI 304

ACABAMENTO / FINISH / ACABADO: STANDARD: SATINADO / SATIN / SATIN

OPTIONAL: PVD TITANIUM COATED

.TB / .TG / .TCO / .TCH

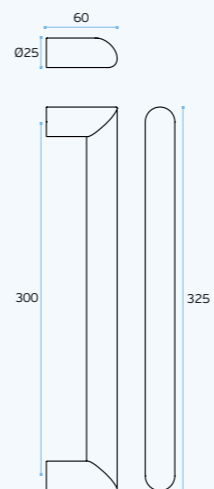

IN.07.141.D ARCO
Asa de porta dupla para vidro / Double door handle for glass / Manillon de puerta doble para cristal.

IN.08.MFU.DV.25
Acessório para asa de porta dupla para vidro / Accessory for double glass door handle / Accesorio para manillon de puerta doble de cristal



MATERIAL: EN 1.4301 / AISI 304

ACABAMENTO / FINISH / ACABADO: STANDARD: SATINADO / SATIN / SATIN

OPTIONAL: PVD TITANIUM COATED

.TB / .TG / .TCO / .TCH

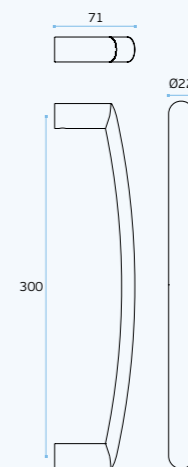

IN.08.MFU.SVO.002
Acessório para asa de porta simples para vidro / Accessory for single glass door handle / Accesorio para manillon de puerta simple para cristal.

SOLID

IN.08.MFU.SV.25
Acessório para asa de porta simples para vidro / Accessory for single glass door handle / Accesorio para manillon de puerta simple para cristal.

TUBULAR

IN.08.MFU.SV.25
Acessório para asa de porta simples para vidro / Accessory for single glass door handle / Accesorio para manillon de puerta simple para cristal.

TUBULAR

IN.08.MFU.SV.25
Acessório para asa de porta simples para vidro / Accessory for single glass door handle / Accesorio para manillon de puerta simple para cristal.

TUBULAR

ASAS PARA PORTAS DE VIDRO / PULL HANDLES FOR GLASS DOORS / MANILLONES PARA PUERTAS DE CRISTAL.

IN.07.123.D NATUR
Asa de porta dupla para vidro /
Double door handle for glass /
Manillon de puerta doble para cristal.

+
IN.08.MFU.DV.19
Acessório para asa de porta dupla
para vidro / Accessory for double
glass door handle / Accesorio para
manillon de puerta doble de cristal



MATERIAL: EN 1.4301 / AISI 304

ACABAMENTO / FINISH / ACABADO:
STANDARD: SATINADO / SATIN / SATIN

OPTIONAL: PVD TITANIUM COATED

.TB / .TG / .TCO / .TCH

A	B
300	344
600	644
900	944



IN.07.123.16.D NATUR
Asa de porta dupla para vidro /
Double door handle for glass /
Manillon de puerta doble para cristal.

+
IN.08.MFU.DV.19
Acessório para asa de porta dupla
para vidro / Accessory for double
glass door handle / Accesorio para
manillon de puerta doble de cristal.



MATERIAL: EN 1.4301 / AISI 304

ACABAMENTO / FINISH / ACABADO:
STANDARD: SATINADO / SATIN / SATIN

OPTIONAL: PVD TITANIUM COATED

.TB / .TG / .TCO / .TCH

A	B
200	244
300	344

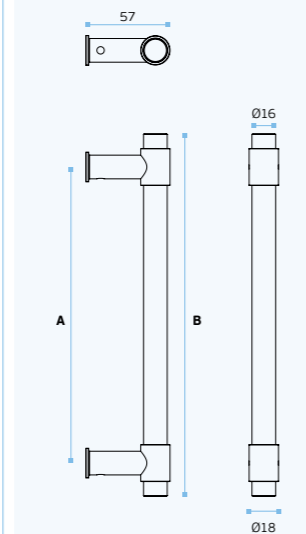

IN.08.MFU.SV.19
Acessório para asa de porta simples para vidro
Accessory for single glass door handle /
Accesorio para manillon de puerta simple para
cristal.

SOLID ■

.P
Polido
Mirror polished
Pulido

.TB
PVD
Titanium
black

.TG
PVD
Titanium
gold

.TCO
PVD
Titanium
copper

.TCH
PVD
Titanium
chocolate

.P
Polido
Mirror polished
Pulido

.TB
PVD
Titanium
black

.TG
PVD
Titanium
gold

.TCO
PVD
Titanium
copper

.TCH
PVD
Titanium
chocolate

IN.07.123.16.D.KN
NATUR WATCH
Asa de porta dupla para vidro /
Double door handle for glass /
Manillon de puerta doble para cristal.

+
IN.08.MFU.DV.19
Acessório para asa de porta dupla
para vidro / Accessory for double
glass door handle / Accesorio para
manillon de puerta doble de cristal



MATERIAL: EN 1.4301 / AISI 304

ACABAMENTO / FINISH / ACABADO:
STANDARD: SATINADO / SATIN / SATIN

OPTIONAL: PVD TITANIUM COATED

.TB / .TG / .TCO / .TCH

A	B
200	244
300	344

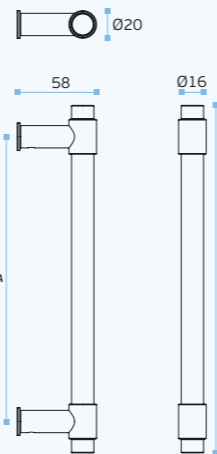

IN.08.MFU.SV.19
Acessório para asa de porta simples para vidro
Accessory for single glass door handle /
Accesorio para manillon de puerta simple para
cristal.

SOLID ■



IN.07.123.16.D.KN.TB + IN.08.MFU.DV.19
Titanium Black



IN.07.123.16.D.KN.TG + IN.08.MFU.DV.19
Titanium Gold



IN.07.123.16.D.KN.TCO + IN.08.MFU.DV.19
Titanium Copper



IN.07.123.16.D.KN.TCH + IN.08.MFU.DV.19
Titanium Chocolate

ASAS PARA PORTAS DE VIDRO /
PULL HANDLES FOR GLASS DOORS /
MANILLONES PARA PUERTAS DE CRISTAL.



IN.07.010.D
Asa de porta dupla /
Double door handle /
Manillon de puerta doble.

.P
Polido
Mirror polished
Pulido

.TB
PVD
Titanium
black

.TG
PVD
Titanium
gold

.TCO
PVD
Titanium
copper

.TCH
PVD
Titanium
chocolate



MATERIAL: EN 1.4301 / AISI 304

ACABAMENTO / FINISH / ACABADO:
SATINADO / SATIN / SATIN

OPTIONAL: PVD TITANIUM COATED

.TB / .TG / .TCO / .TCH

DESIGN: MIGUEL VASCONCELOS

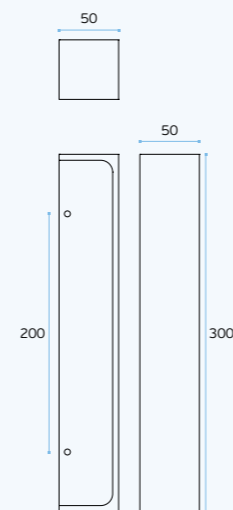

SOLID ■

ACESSÓRIOS / ACCESSORIES

MFU M6 --- INCLUDED

PREPARADA PARA VIDRO /
READY FOR GLASS

IN.07.013.D
Asa de porta dupla /
Double door handle /
Manillon de puerta doble.



MATERIAL: EN 1.4301 / AISI 304

ACABAMENTO / FINISH / ACABADO:
SATINADO / SATIN / SATIN

OPTIONAL: PVD TITANIUM COATED

.TB / .TG / .TCO / .TCH

DESIGN: MIGUEL VASCONCELOS

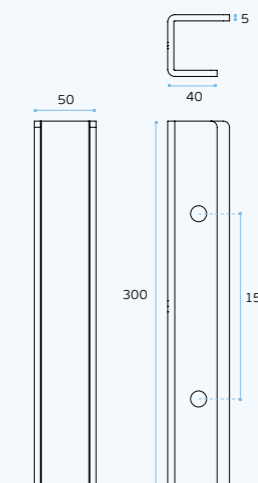

SOLID ■

ACESSÓRIOS / ACCESSORIES

AAM --- INCLUDED

PREPARADA PARA VIDRO /
READY FOR GLASS

ASAS PARA PORTAS DE VIDRO / PULL HANDLES FOR GLASS DOORS / MANILLONES PARA PUERTAS DE CRISTAL.

IN.07.006.D

Asa de porta dupla para vidro /
Double door handle for glass /
Manillon de puerta doble para cristal.

+
IN.08.MFU.DVR.36X23
Acessório para asa de porta dupla
para vidro / Accessory for double
glass door handle / Accesorio para
manillon de puerta doble de cristal.



MATERIAL: EN 1.4301 / AISI 304

ACABAMENTO / FINISH / ACABADO:
STANDARD: SATINADO / SATIN / SATIN

OPTIONAL: PVD TITANIUM COATED

.TB / .TG / .TCO / .TCH

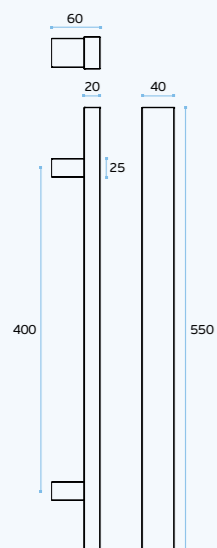

IN.08.MFU.SVR.36X23

Acessório para asa de porta simples para vidro
Accessory for single glass door handle /
Accesorio para Manillon de puerta simple para
cristal.cristal.

TUBULAR

IN.07.005.D

Asa de porta dupla para vidro /
Double door handle for glass /
Manillon de puerta doble para cristal.

+
IN.08.MFU.DVR.40X20
Acessório para asa de porta dupla
para vidro / Accessory for double
glass door handle / Accesorio para
manillon de puerta doble de cristal



MATERIAL: EN 1.4301 / AISI 304

ACABAMENTO / FINISH / ACABADO:
STANDARD: SATINADO / SATIN / SATIN

OPTIONAL: PVD TITANIUM COATED

.TB / .TG / .TCO / .TCH

A	B
600	620
1250(**)	1270

(*) Acabamento em PVD titânio até 1000mm
/ PVD titanium finish until 1000mm / Acabado en
PVD titânio hasta 1000mm.

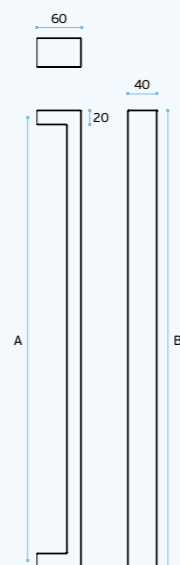

IN.08.MFU.SVR.40X20

Acessório para asa de porta simples para vidro
Accessory for single glass door handle /
Accesorio para Manillon de puerta simple para
cristal.cristal.

TUBULAR



ASAS PARA PORTAS DE VIDRO / PULL HANDLES FOR GLASS DOORS / MANILLONES PARA PUERTAS DE CRISTAL.

IN.07.142.D SQUARE
Asa de porta dupla para vidro /
Double door handle for glass /
Manillon de puerta doble para cristal.

+
IN.08.MFU.DVQ.30
Acessório para asa de porta dupla
para vidro / Accessory for double
glass door handle / Accesorio para
manillon de puerta doble de cristal.



MATERIAL: EN 1.4301 / AISI 304

ACABAMENTO / FINISH / ACABADO:
STANDARD: SATINADO + POLIDO /
SATIN + POLISHED / SATIN + PULIDO

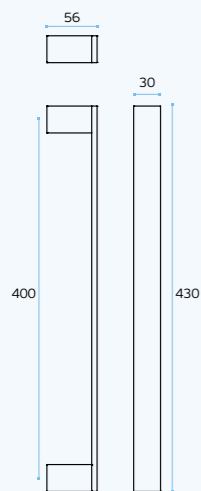

IN.08.MFU.SVQ.30
Acessório para asa de porta simples para vidro
Accessory for single glass door handle /
Accesorio para Manillon de puerta simple para
cristal.cristal.

SOLID ■



IN.07.153.D SQUARE
Asa de porta dupla para vidro /
Double door handle for glass /
Manillon de puerta doble para cristal.

+
IN.08.MFU.DVQ.30
Acessório para asa de porta dupla
para vidro / Accessory for double
glass door handle / Accesorio para
manillon de puerta doble de cristal



MATERIAL: EN 1.4301 / AISI 304

ACABAMENTO / FINISH / ACABADO:
STANDARD: SATINADO / SATIN / SATIN

OPTIONAL: PVD TITANIUM COATED

.TB / .TG / .TCO / .TCH

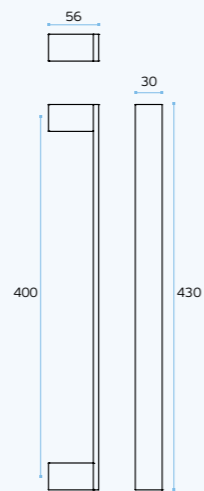

IN.08.MFU.SVQ.30
Acessório para asa de porta simples para vidro
Accessory for single glass door handle /
Accesorio para Manillon de puerta simple para
cristal.cristal.

SOLID ■



.P
Polido
Mirror polished
Pulido

.TB
PVD
Titanium
black

.TG
PVD
Titanium
gold

.TCO
PVD
Titanium
copper

.TCH
PVD
Titanium
chocolate

.P
Polido
Mirror polished
Pulido

.TB
PVD
Titanium
black

.TG
PVD
Titanium
gold

.TCO
PVD
Titanium
copper

.TCH
PVD
Titanium
chocolate

IN.07.296.D
Asa de porta dupla para vidro /
Double door handle for glass /
Manillon de puerta doble para cristal.
+
IN.08.MFU.DVR.16X32
Acessório para asa de porta dupla
para vidro / Accessory for double
glass door handle / Accesorio para
manillon de puerta doble de cristal.



MATERIAL: EN 1.4301 / AISI 304

ACABAMENTO / FINISH / ACABADO:
STANDARD: SATINADO / SATIN / SATIN

OPTIONAL: PVD TITANIUM COATED

.TB / .TG / .TCO / .TCH

A	B
600	632
1250(*)	1282

(*) Acabamento em PVD titânio até 1000mm
/ PVD titanium finish until 1000mm / Acabado en
PVD titanio hasta 1000mm.

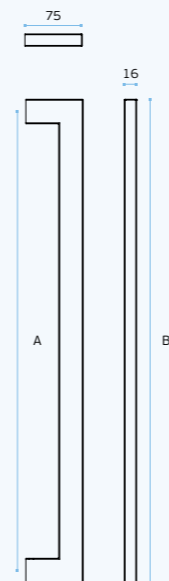

IN.08.MFU.SVR.16X32
Acessório para asa de porta simples para vidro
Accessory for single glass door handle /
Accesorio para Manillon de puerta simple para
cristal.cristal.

TUBULAR □



IN.07.143.D
Asa de porta dupla para vidro /
Double door handle for glass /
Manillon de puerta doble para cristal.
+
IN.08.MFU.DVQ.19
Acessório para asa de porta dupla
para vidro / Accessory for double
glass door handle / Accesorio para
manillon de puerta doble de cristal.



MATERIAL: EN 1.4301 / AISI 304

ACABAMENTO / FINISH / ACABADO:
STANDARD: SATINADO / SATIN / SATIN

OPTIONAL: PVD TITANIUM COATED

.TB / .TG / .TCO / .TCH

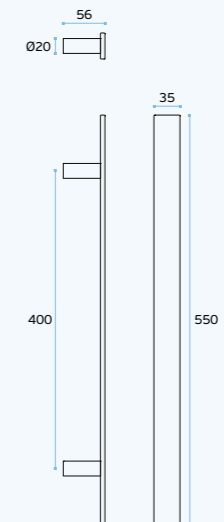

IN.08.MFU.SV.19
Acessório para asa de porta simples para vidro
Accessory for single glass door handle /
Accesorio para Manillon de puerta simple para
cristal.cristal.

SOLID ■

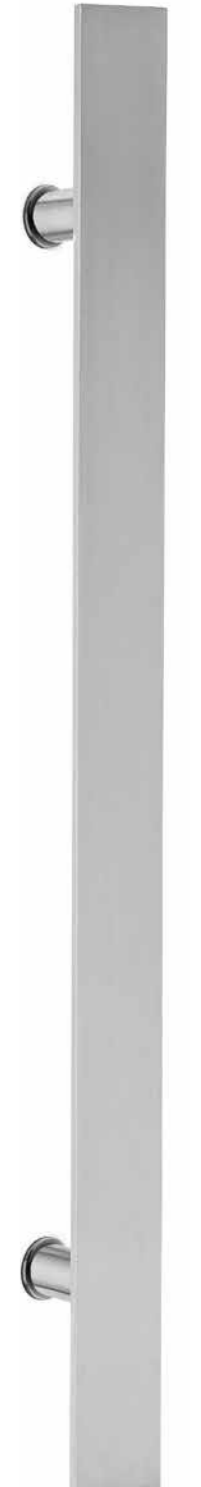

ASAS PARA PORTAS DE VIDRO / PULL HANDLES FOR GLASS DOORS / MANILLONES PARA PUERTAS DE CRISTAL.

IN.07.200.D.16
Asa de porta dupla para vidro / Double door handle for glass / Manillon de puerta doble para cristal.

+ **IN.08.MFU.DVQ.16**
Acessório para asa de porta dupla para vidro / Accessory for double glass door handle / Accesorio para manillon de puerta doble de cristal.



MATERIAL: EN 1.4301 / AISI 304
ACABAMENTO / FINISH / ACABADO:
STANDARD: SATINADO / SATIN / SATIN
OPTIONAL: PVD TITANIUM COATED

.TB / .TG / .TCO / .TCH	
A	B
300	316
600	616

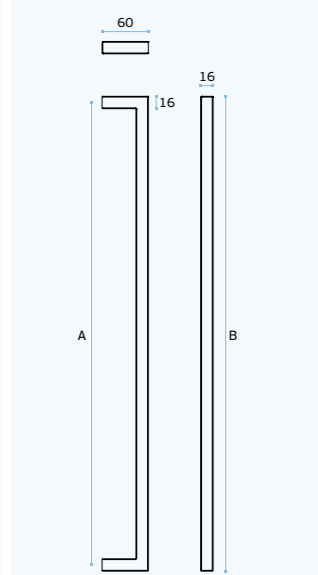

IN.08.MFU.SVQ.16
Acessório para asa de porta simples para vidro / Accessory for single glass door handle / Accesorio para Manillon de puerta simple para cristal.cristal.

TUBULAR

IN.07.200.D.25
Asa de porta dupla para vidro / Double door handle for glass / Manillon de puerta doble para cristal.

+ **IN.08.MFU.DVQ.25**
Acessório para asa de porta dupla para vidro / Accessory for double glass door handle / Accesorio para manillon de puerta doble de cristal.



MATERIAL: EN 1.4301 / AISI 304
ACABAMENTO / FINISH / ACABADO:
STANDARD: SATINADO / SATIN / SATIN
OPTIONAL: PVD TITANIUM COATED

.TB / .TG / .TCO / .TCH	
A	B
300	325
600	625
1250(**)	1275

(*) Acabamento em PVD titânio até 1000mm / PVD titanium finish until 1000mm / Acabado en PVD titânio hasta 1000mm.

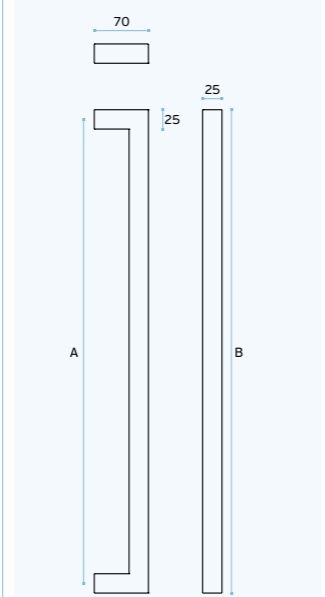

IN.08.MFU.SVQ.25
Acessório para asa de porta simples para vidro / Accessory for single glass door handle / Accesorio para Manillon de puerta simple para cristal.cristal.

TUBULAR

.P
Polido
Mirror polished
Pulido

.TB
PVD
Titanium
black

.TG
PVD
Titanium
gold

.TCO
PVD
Titanium
copper

.TCH
PVD
Titanium
chocolate

.P
Polido
Mirror polished
Pulido

.TB
PVD
Titanium
black

.TG
PVD
Titanium
gold

.TCO
PVD
Titanium
copper

.TCH
PVD
Titanium
chocolate

IN.07.295.D
Asa de porta dupla para vidro / Double door handle for glass / Manillon de puerta doble para cristal.

+ **IN.08.MFU.DVO.295**
Acessório para asa de porta dupla para vidro / Accessory for double glass door handle / Accesorio para manillon de puerta doble de cristal.



MATERIAL: EN 1.4301 / AISI 304
ACABAMENTO / FINISH / ACABADO:
STANDARD: SATINADO / SATIN / SATIN
OPTIONAL: PVD TITANIUM COATED

.TB / .TG / .TCO / .TCH	
-------------------------	--

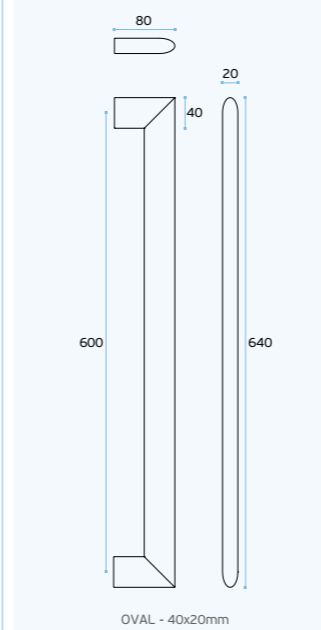

IN.08.MFU.SVO.295
Acessório para asa de porta simples para vidro / Accessory for single glass door handle / Accesorio para Manillon de puerta simple para cristal.cristal.

TUBULAR



ASAS PARA PORTAS DE VIDRO / PULL HANDLES FOR GLASS DOORS / MANILLONES PARA PUERTAS DE CRISTAL.

IN.07.004.D

Asa de porta dupla para vidro /
Double door handle for glass /
Manillon de puerta doble para cristal.

+ IN.08.MFU.DV.19

Acessório para asa de porta dupla
para vidro / Accessory for double
glass door handle / Accesorio para
manillon de puerta doble de cristal.



MATERIAL: EN 1.4301 / AISI 304

ACABAMENTO / FINISH / ACABADO:
STANDARD: SATINADO / SATIN / SATIN

OPTIONAL: PVD TITANIUM COATED

.TB / .TG / .TCO / .TCH

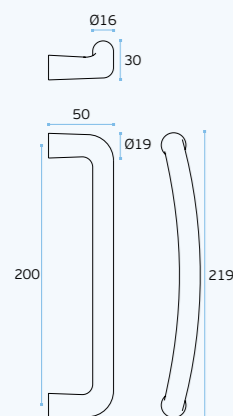

IN.08.MFU.SV.19

Acessório para asa de porta simples para vidro
Accessory for single glass door handle /
Accesorio para Manillon de puerta simple para
cristal.cristal.

SOLID ■



IN.07.292.D

Asa de porta dupla para vidro /
Double door handle for glass /
Manillon de puerta doble para cristal.

+ IN.08.MFU.DV.30

Acessório para asa de porta dupla
para vidro / Accessory for double
glass door handle / Accesorio para
manillon de puerta doble de cristal.



MATERIAL: EN 1.4301 / AISI 304

ACABAMENTO / FINISH / ACABADO:
STANDARD: SATINADO / SATIN / SATIN

OPTIONAL: PVD TITANIUM COATED

.TB / .TG / .TCO / .TCH

A

250 / 300 / 350 / 425 /

600 / 900 / 1250(**) / 2000(**)

(*) Acabamento em PVD titânio até 1000mm
/ PVD titanium finish until 1000mm / Acabado en
PVD titânio hasta 1000mm.

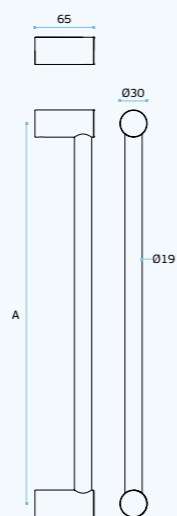

IN.08.MFU.SV.30

Acessório para asa de porta simples para vidro
Accessory for single glass door handle /
Accesorio para Manillon de puerta simple para
cristal.cristal.

SEMI SOLID ■



.P
Polido
Mirror polished
Pulido

.TB
PVD
Titanium
black

.TG
PVD
Titanium
gold

.TCO
PVD
Titanium
copper

.TCH
PVD
Titanium
chocolate

.P
Polido
Mirror polished
Pulido

.TB
PVD
Titanium
black

.TG
PVD
Titanium
gold

.TCO
PVD
Titanium
copper

.TCH
PVD
Titanium
chocolate

IN.07.290

Asa de porta dupla para vidro /
Double door handle for glass /
Manillon de puerta doble para cristal.

+ IN.08.MFU.DV.35

Acessório para asa de porta dupla
para vidro / Accessory for double
glass door handle / Accesorio para
manillon de puerta doble de cristal.



MATERIAL: EN 1.4301 / AISI 304

ACABAMENTO / FINISH / ACABADO:
STANDARD: SATINADO / SATIN / SATIN



IN.08.MFU.SV.35

Acessório para asa de porta simples para vidro
Accessory for single glass door handle /
Accesorio para Manillon de puerta simple para
cristal.cristal.

TUBULAR □



IN.07.291.D

Asa de porta dupla para vidro /
Double door handle for glass /
Manillon de puerta doble para cristal.

+ IN.08.MFU.DV.30

Acessório para asa de porta dupla
para vidro / Accessory for double
glass door handle / Accesorio para
manillon de puerta doble de cristal.



MATERIAL: EN 1.4301 / AISI 304

ACABAMENTO / FINISH / ACABADO:
STANDARD: SATINADO / SATIN / SATIN

OPTIONAL: PVD TITANIUM COATED

.TB / .TG / .TCO / .TCH

A - 250 / 300 / 425 / 600

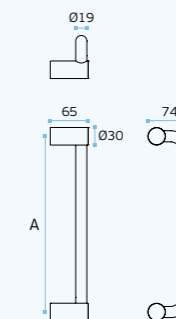

IN.08.MFU.SV.30

Acessório para asa de porta simples para vidro
Accessory for single glass door handle /
Accesorio para Manillon de puerta simple para
cristal.cristal.

SOLID ■



ASAS PARA PORTAS DE VIDRO / PULL HANDLES FOR GLASS DOORS / MANILLONES PARA PUERTAS DE CRISTAL.



IN.07.412.D LINK

Asa de porta dupla para vidro /
Double door handle for glass /
Manillon de puerta doble para cristal.

+ IN.08.MFU.DV.22

Acessório para asa de porta dupla
para vidro / Accessory for double
glass door handle / Accesorio para
manillon de puerta doble de cristal.

.P
Polido
Mirror polished
Pulido

.TB
PVD
Titanium
black

.TG
PVD
Titanium
gold

.TCO
PVD
Titanium
copper

.TCH
PVD
Titanium
chocolate



MATERIAL: EN 1.4301 / AISI 304

ACABAMENTO / FINISH / ACABADO:
STANDARD: SATINADO / SATIN / SATIN

OPTIONAL: PVD TITANIUM COATED

.TB / .TG / .TCO / .TCH

A	B
250	272
425	447
600	622



ANTI-BACTERIAL
Copper material

PATINA NATURAL
A pega de
cobre da asa
propositadamente
não tem
tratamento
de superfície,
para que possa
desenvolver a sua
própria patina ao
longo do tempo
conforme o uso e
o ambiente onde
está inserido.

NATURAL PATINA
The pull handle
copper part doesn't
have a surface
coating on purpose,
so it can develop
its own patina over
the time according
to the use and the
environment where
it is inserted.

IN.08.MFU.SV.22

Acessório para asa de porta simples para vidro
Accessory for single glass door handle /
Accesorio para Manillon de puerta simple para
cristal.cristal.

SEMI SOLID



IN.07.409.D LINK COPPER

Asa de porta dupla para vidro /
Double door handle for glass /
Manillon de puerta doble para cristal.

+ IN.08.MFU.DV.22 Acessório para
asa de porta dupla para vidro / Accessory
for double glass door handle / Accesorio
para manillon de puerta doble de cristal.



MATERIAL: EN 1.4301 / AISI 304

ACABAMENTO / FINISH / ACABADO:
STANDARD: SATINADO / SATIN / SATIN
+ COBRE / COPPER / COBRE

OPTIONAL: PVD TITANIUM COATED

.TB / .TG / .TCO / .TCH

A	B
250	272
425	447
600	622

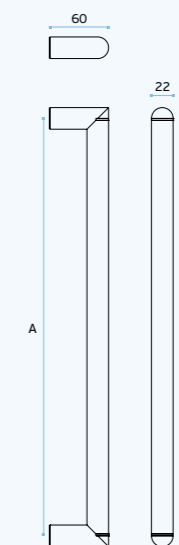

IN.08.MFU.SV.22

Acessório para asa de porta simples para vidro
Accessory for single glass door handle /
Accesorio para Manillon de puerta simple para
cristal.cristal.

SEMI SOLID



ANTI-BACTERIAL
Copper material

ASAS PARA PORTAS DE VIDRO / PULL HANDLES FOR GLASS DOORS / MANILLONES PARA PUERTAS DE CRISTAL.

IN.07.185.D LOFT
Asa de porta dupla para vidro / Double door handle for glass / Manillon de puerta doble para cristal.

IN.08.MFU.DV.25
Acessório para asa de porta dupla para vidro / Accessory for double glass door handle / Accesorio para manillon de puerta doble de cristal.



MATERIAL: EN 1.4301 / AISI 304

ACABAMENTO / FINISH / ACABADO:
STANDARD: SATINADO / SATIN / SATIN + RAL 9005

OPTIONAL: PVD TITANIUM COATED

.TB / .TG / .TCO / .TCH

DESIGN: CHRISTIAN MAGALHÃES

A	B
250	290
400	440
600	640
900	940

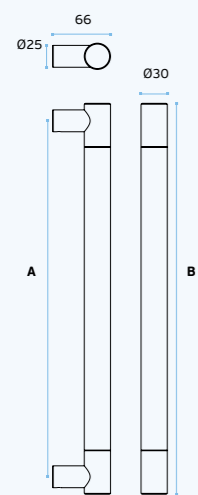

IN.08.MFU.SV.25
Acessório para asa de porta simples para vidro / Accessory for single glass door handle / Accesorio para Manillon de puerta simple para cristal.cristal.

SOLID ■



IN.07.185.D.250.TB + IN.08.MFU.DV.25
PVD Titanium Black



IN.07.185.250.TG + IN.08.MFU.DV.25
PVD Titanium Gold



IN.07.185.D.250.TCO + IN.08.MFU.DV.25
PVD Titanium Copper



IN.07.185.D.250.TCH + IN.08.MFU.DV.25
PVD Titanium Chocolate

P
Polido
Mirror polished
Pulido

.TB
PVD
Titanium
black

.TG
PVD
Titanium
gold

.TCO
PVD
Titanium
copper

.TCH
PVD
Titanium
chocolate

P
Polido
Mirror polished
Pulido

.TB
PVD
Titanium
black

.TG
PVD
Titanium
gold

.TCO
PVD
Titanium
copper

.TCH
PVD
Titanium
chocolate

IN.07.418.D WENGÉ
Asa de porta dupla para vidro / Double door handle for glass / Manillon de puerta doble para cristal.

IN.08.MFU.DV.22
Acessório para asa de porta dupla para vidro / Accessory for double glass door handle / Accesorio para manillon de puerta doble de cristal.



MATERIAL: EN 1.4301 / AISI 304

ACABAMENTO / FINISH / ACABADO:
STANDARD: SATINADO / SATIN / SATIN

OPTIONAL: PVD TITANIUM COATED

.TB / .TG / .TCO / .TCH

DESIGN: PEDRO QUEIRÓS

A	B
250	305
425	480
600	655

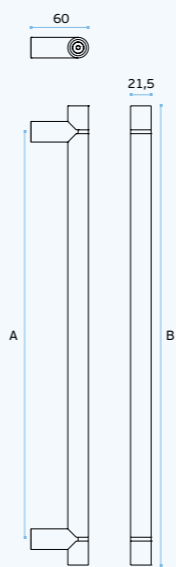

IN.08.MFU.SV.22
Acessório para asa de porta simples para vidro / Accessory for single glass door handle / Accesorio para Manillon de puerta simple para cristal.cristal.

SOLID ■



NEW

IN.07.411.C.D LINK OAK
Asa de porta dupla para vidro / Double door handle for glass / Manillon de puerta doble para cristal.

IN.08.MFU.DV.22
Acessório para asa de porta dupla para vidro / Accessory for double glass door handle / Accesorio para manillon de puerta doble de cristal.



MATERIAL: EN 1.4301 / AISI 304

ACABAMENTO / FINISH / ACABADO:
STANDARD: SATINADO / SATIN / SATIN + MADEIRA / WOOD / MADERA

OPTIONAL: PVD TITANIUM COATED

.TB / .TG / .TCO / .TCH

A	B
250	272
425	447
600	622

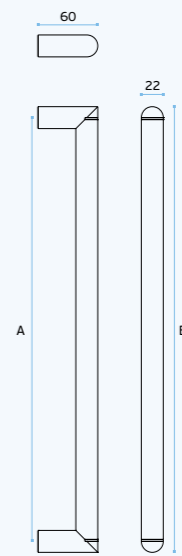

IN.08.MFU.SV.22
Acessório para asa de porta simples para vidro / Accessory for single glass door handle / Accesorio para Manillon de puerta simple para cristal.cristal.

SEMI SOLID ■



ASAS PARA PORTAS DE VIDRO / PULL HANDLES FOR GLASS DOORS / MANILLONES PARA PUERTAS DE CRISTAL.

IN.07.281.SD

Asa de porta dupla para vidro / Double door handle for glass / Manillon de puerta doble para cristal.

IN.08.MFU.DV.19

Acessório para asa de porta dupla para vidro / Accessory for double glass door handle / Accesorio para manillon de puerta doble de cristal.



MATERIAL: EN 1.4301 / AISI 304

ACABAMENTO / FINISH / ACABADO: STANDARD: SATINADO / SATIN / SATIN

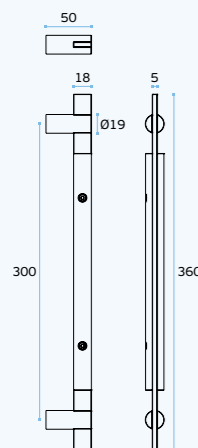

IN.08.MFU.SV.19

Acessório para asa de porta simples para vidro / Accessory for single glass door handle / Accesorio para Manillon de puerta simple para cristal.cristal.

SOLID ■

IN.07.003.D

Asa de porta dupla para vidro / Double door handle for glass / Manillon de puerta doble para cristal.

IN.08.MFU.DV.19

Acessório para asa de porta dupla para vidro / Accessory for double glass door handle / Accesorio para manillon de puerta doble de cristal.



MATERIAL: EN 1.4301 / AISI 304

ACABAMENTO / FINISH / ACABADO: STANDARD: SATINADO / SATIN / SATIN + JET FINISH

OPTIONAL: PVD TITANIUM COATED

.TB / .TG / .TCO / .TCH

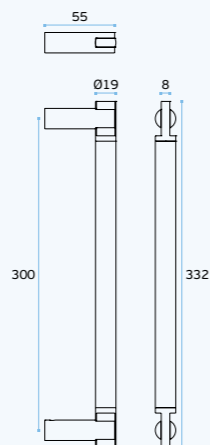

IN.08.MFU.SV.19

Acessório para asa de porta simples para vidro / Accessory for single glass door handle / Accesorio para Manillon de puerta simple para cristal.cristal.

SEMI SOLID ■

P Polido Mirror polished Pulido

.TB PVD Titanium black

.TG PVD Titanium gold

.TCO PVD Titanium copper

.TCH PVD Titanium chocolate

P Polido Mirror polished Pulido

.TB PVD Titanium black

.TG PVD Titanium gold

.TCO PVD Titanium copper

.TCH PVD Titanium chocolate

IN.07.003.SD

Asa de porta dupla para vidro / Double door handle for glass / Manillon de puerta doble para cristal.

IN.08.MFU.DV.19

Acessório para asa de porta dupla para vidro / Accessory for double glass door handle / Accesorio para manillon de puerta doble de cristal.



MATERIAL: EN 1.4301 / AISI 304

ACABAMENTO / FINISH / ACABADO: STANDARD: SATINADO / SATIN / SATIN

OPTIONAL: PVD TITANIUM COATED

.TB / .TG / .TCO / .TCH

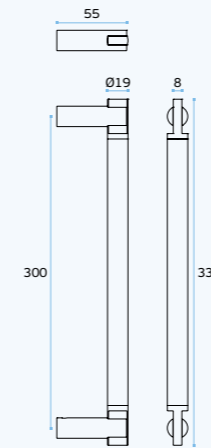

IN.08.MFU.SV.19

Acessório para asa de porta simples para vidro / Accessory for single glass door handle / Accesorio para Manillon de puerta simple para cristal.cristal.

SEMI SOLID ■



IN.07.003.SD.TB + IN.08.MFU.DV.19 PVD Titanium Black



IN.07.003.SD.TG + IN.08.MFU.DV.19 PVD Titanium Gold

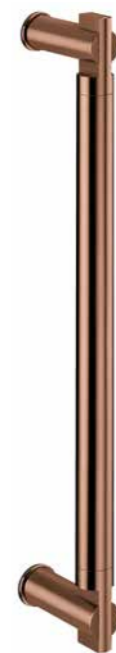

IN.07.003.SD.TCO + IN.08.MFU.DV.19 PVD Titanium Copper



IN.07.003.SD.TCH + IN.08.MFU.DV.19 PVD Titanium Chocolate

ASAS PARA PORTAS DE VIDRO / PULL HANDLES FOR GLASS DOORS / MANILLONES PARA PUERTAS DE CRISTAL.



IN.07.204.D.16

Asa de porta dupla para vidro /
Double door handle for glass /
Manillon de puerta doble para cristal.

IN.08.MFU.DV.16

Accessório para asa de porta dupla
para vidro / Accessory for double
glass door handle / Accesorio para
manillon de puerta doble de cristal.

P
Polido
Mirror polished
Pulido

.TB
PVD
Titanium
black

.TG
PVD
Titanium
gold

.TCO
PVD
Titanium
copper

.TCH
PVD
Titanium
chocolate

MATERIAL: EN 1.4301 / AISI 304

**ACABAMENTO / FINISH / ACABADO:
STANDARD:** SATINADO / SATIN / SATIN

OPTIONAL: PVD TITANIUM COATED

.TB / .TG / .TCO / .TCH

A	B
250	266
300	316
425	441
600	616

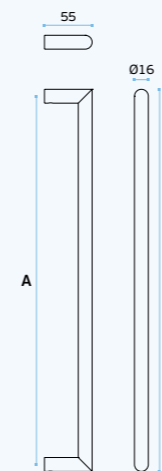

IN.08.MFU.SV.16

Accessório para asa de porta simples para vidro
Accessory for single glass door handle /
Accesorio para Manillon de puerta simple para
cristal.cristal.

TUBULAR

IN.07.204.D.19

Asa de porta dupla para vidro /
Double door handle for glass /
Manillon de puerta doble para cristal.

IN.08.MFU.DV.19

Accessório para asa de porta dupla
para vidro / Accessory for double
glass door handle / Accesorio para
manillon de puerta doble de cristal.

.TB **.TG** **.TCO** **.TCH**

MATERIAL: EN 1.4301 / AISI 304

**ACABAMENTO / FINISH / ACABADO:
STANDARD:** SATINADO / SATIN / SATIN

OPTIONAL: PVD TITANIUM COATED

.TB / .TG / .TCO / .TCH

A	B
150	169
200	219
250	269
300	319
400	419
425	444
600	619

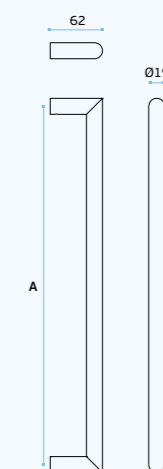

IN.08.MFU.SV.19

Accessório para asa de porta simples para vidro
Accessory for single glass door handle /
Accesorio para Manillon de puerta simple para
cristal.cristal.

TUBULAR

ASAS PARA PORTAS DE VIDRO / PULL HANDLES FOR GLASS DOORS / MANILLONES PARA PUERTAS DE CRISTAL.

IN.07.204.D.25

Asa de porta dupla para vidro /
Double door handle for glass /
Manillon de puerta doble para cristal.

IN.08.MFU.DV.25

Acessório para asa de porta dupla
para vidro / Accessory for double
glass door handle / Accesorio para
manillon de puerta doble de cristal.



MATERIAL: EN 1.4301 / AISI 304

ACABAMENTO / FINISH / ACABADO:
STANDARD: SATINADO / SATIN / SATIN

OPTIONAL: PVD TITANIUM COATED

.TB / .TG / .TCO / .TCH

A	B
250	275
300	325
400	425
425	450
600	625
1250(*)	1275

(*) Acabamento em PVD titânio até 1000mm
/ PVD titanium finish until 1000mm / Acabado en
PVD titanio hasta 1000mm.

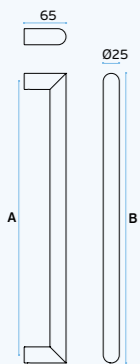

IN.08.MFU.SV.25

Acessório para asa de porta simples para vidro
Accessory for single glass door handle /
Accesorio para Manillon de puerta simple para
cristal.cristal.

TUBULAR

IN.07.204.D.30

Asa de porta dupla para vidro /
Double door handle for glass /
Manillon de puerta doble para cristal.

IN.08.MFU.DV.30

Acessório para asa de porta dupla
para vidro / Accessory for double
glass door handle / Accesorio para
manillon de puerta doble de cristal.



MATERIAL: EN 1.4301 / AISI 304

ACABAMENTO / FINISH / ACABADO:
STANDARD: SATINADO / SATIN / SATIN

OPTIONAL: PVD TITANIUM COATED

.TB / .TG / .TCO / .TCH

A	B
350	380
400	430
425	455
600	455
1250(*)	1280

(*) Acabamento em PVD titânio até 1000mm
/ PVD titanium finish until 1000mm / Acabado en
PVD titanio hasta 1000mm.

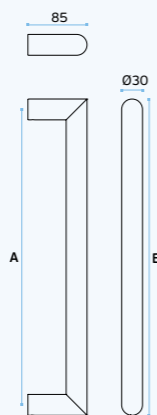

IN.08.MFU.SV.30

Acessório para asa de porta simples para vidro
Accessory for single glass door handle /
Accesorio para Manillon de puerta simple para
cristal.cristal.

TUBULAR

.P
Polido
Mirror polished
Pulido

.TB
PVD
Titanium
black

.TG
PVD
Titanium
gold

.TCO
PVD
Titanium
copper

.TCH
PVD
Titanium
chocolate

.P
Polido
Mirror polished
Pulido

.TB
PVD
Titanium
black

.TG
PVD
Titanium
gold

.TCO
PVD
Titanium
copper

.TCH
PVD
Titanium
chocolate

IN.07.204.D.35

Asa de porta dupla para vidro /
Double door handle for glass /
Manillon de puerta doble para cristal.

IN.08.MFU.DV.35

Acessório para asa de porta dupla
para vidro / Accessory for double
glass door handle / Accesorio para
manillon de puerta doble de cristal.



MATERIAL: EN 1.4301 / AISI 304

ACABAMENTO / FINISH / ACABADO:
STANDARD: SATINADO / SATIN / SATIN

OPTIONAL: PVD TITANIUM COATED

.TB / .TG / .TCO / .TCH

A	B
425	460
600	635
1250(*)	1285

(*) Acabamento em PVD titânio até 1000mm
/ PVD titanium finish until 1000mm / Acabado en
PVD titanio hasta 1000mm.

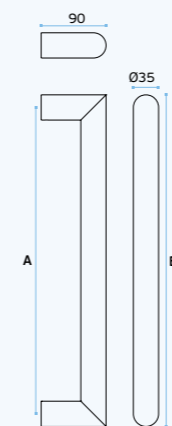

IN.08.MFU.SV.35

Acessório para asa de porta simples para vidro
Accessory for single glass door handle /
Accesorio para Manillon de puerta simple para
cristal.cristal.

TUBULAR

IN.07.207.D.35

Asa de porta dupla para vidro /
Double door handle for glass /
Manillon de puerta doble para cristal.

IN.08.MFU.DV.35

Acessório para asa de porta dupla
para vidro / Accessory for double
glass door handle / Accesorio para
manillon de puerta doble de cristal.



MATERIAL: EN 1.4301 / AISI 304

ACABAMENTO / FINISH / ACABADO:
STANDARD: SATINADO / SATIN / SATIN

OPTIONAL: PVD TITANIUM COATED

.TB / .TG / .TCO / .TCH

A	B
425	460
600	635
1250(*)	1285

(*) Acabamento em PVD titânio até 1000mm
/ PVD titanium finish until 1000mm / Acabado en
PVD titanio hasta 1000mm.

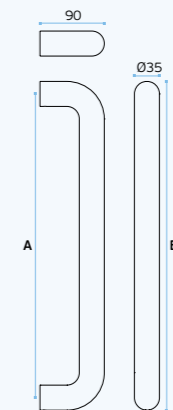

IN.08.MFU.SV.35

Acessório para asa de porta simples para vidro
Accessory for single glass door handle /
Accesorio para Manillon de puerta simple para
cristal.cristal.

TUBULAR

ASAS PARA PORTAS DE VIDRO / PULL HANDLES FOR GLASS DOORS / MANILLONES PARA PUERTAS DE CRISTAL.

IN.07.207.D.30

Asa de porta dupla para vidro /
 Double door handle for glass /
 Manillon de puerta doble para cristal.

+

IN.08.MFU.DV.30

Accessório para asa de porta dupla
 para vidro / Accessory for double
 glass door handle / Accesorio para
 manillon de puerta doble de cristal.



MATERIAL: EN 1.4301 / AISI 304

ACABAMENTO / FINISH / ACABADO:
 STANDARD: SATINADO / SATIN / SATIN

OPTIONAL: PVD TITANIUM COATED

.TB / .TG / .TCO / .TCH

A	B
300	330
350	380
400	430
425	455
600	630
1250(*)	1280

(*) Acabamento em PVD titânio até 1000mm
 / PVD titanium finish until 1000mm / Acabado en
 PVD titânio hasta 1000mm.

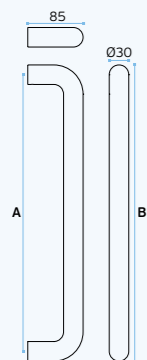

IN.08.MFU.SV.30

Accessório para asa de porta simples para vidro
 Accessory for single glass door handle /
 Accesorio para Manillon de puerta simple para
 cristal.cristal.

TUBULAR

IN.07.207.D.25

Asa de porta dupla para vidro /
 Double door handle for glass /
 Manillon de puerta doble para cristal.

+

IN.08.MFU.DV.25

Accessório para asa de porta dupla
 para vidro / Accessory for double
 glass door handle / Accesorio para
 manillon de puerta doble de cristal.



MATERIAL: EN 1.4301 / AISI 304

ACABAMENTO / FINISH / ACABADO:
 STANDARD: SATINADO / SATIN / SATIN

OPTIONAL: PVD TITANIUM COATED

.TB / .TG / .TCO / .TCH

A	B
250	275
300	325
400	425
425	450
600	625
1250(*)	1275

(*) Acabamento em PVD titânio até 1000mm
 / PVD titanium finish until 1000mm / Acabado en
 PVD titânio hasta 1000mm.

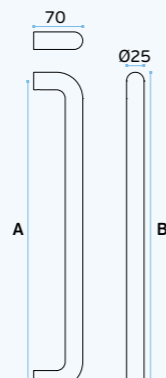

IN.08.MFU.SV.25

Accessório para asa de porta simples para vidro
 Accessory for single glass door handle /
 Accesorio para Manillon de puerta simple para
 cristal.cristal.

TUBULAR

.P
 Polido
 Mirror polished
 Pulido

.TB
 PVD
 Titanium
 black

.TG
 PVD
 Titanium
 gold

.TCO
 PVD
 Titanium
 copper

.TCH
 PVD
 Titanium
 chocolate

.P
 Polido
 Mirror polished
 Pulido

.TB
 PVD
 Titanium
 black

.TG
 PVD
 Titanium
 gold

.TCO
 PVD
 Titanium
 copper

.TCH
 PVD
 Titanium
 chocolate

IN.07.207.D.19

Asa de porta dupla para vidro /
 Double door handle for glass /
 Manillon de puerta doble para cristal.

+

IN.08.MFU.DV.19

Accessório para asa de porta dupla
 para vidro / Accessory for double
 glass door handle / Accesorio para
 manillon de puerta doble de cristal.



MATERIAL: EN 1.4301 / AISI 304

ACABAMENTO / FINISH / ACABADO:
 STANDARD: SATINADO / SATIN / SATIN

OPTIONAL: PVD TITANIUM COATED

.TB / .TG / .TCO / .TCH

A	B
150	169
200	219
250	169
300	319
400	419
425	444
600	619

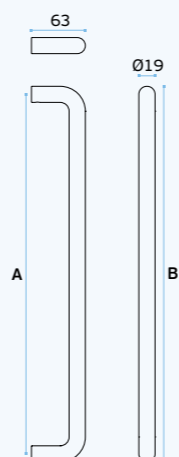

IN.08.MFU.SV.19

Accessório para asa de porta simples para vidro
 Accessory for single glass door handle /
 Accesorio para Manillon de puerta simple para
 cristal.cristal.

TUBULAR

IN.07.207.D.16

Asa de porta dupla para vidro /
 Double door handle for glass /
 Manillon de puerta doble para cristal.

+

IN.08.MFU.DV.16

Accessório para asa de porta dupla
 para vidro / Accessory for double
 glass door handle / Accesorio para
 manillon de puerta doble de cristal.



MATERIAL: EN 1.4301 / AISI 304

ACABAMENTO / FINISH / ACABADO:
 STANDARD: SATINADO / SATIN / SATIN

OPTIONAL: PVD TITANIUM COATED

.TB / .TG / .TCO / .TCH

A	B
150	166
200	216
250	266
300	316
425	441
600	616

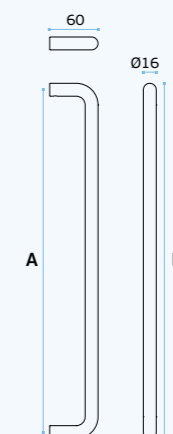

IN.08.MFU.SV.16

Accessório para asa de porta simples para vidro
 Accessory for single glass door handle /
 Accesorio para Manillon de puerta simple para
 cristal.cristal.

TUBULAR

ASAS PARA PORTAS DE VIDRO / PULL HANDLES FOR GLASS DOORS / MANILLONES PARA PUERTAS DE CRISTAL.



IN.07.286.D.20

Asa de porta dupla para vidro /
Double door handle for glass /
Manillon de puerta doble para cristal.

+
IN.08.MFU.DV.19
Acessório para asa de porta dupla
para vidro / Accessory for double
glass door handle / Accesorio para
manillon de puerta doble de cristal.



MATERIAL: EN 1.4301 / AISI 304

ACABAMENTO / FINISH / ACABADO:
STANDARD: SATINADO / SATIN / SATIN

OPTIONAL: PVD TITANIUM COATED

.TB / .TG / .TCO / .TCH

A	B
200	350
250	400
300	450
350	500
400	550
450	600
550	700

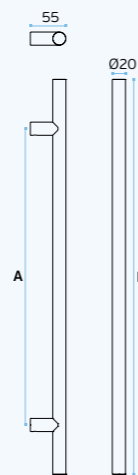

IN.08.MFU.SV.19

Acessório para asa de porta simples para vidro
Accessory for single glass door pull handle /
Accesorio para Manillon de puerta simple para
cristal.cristal.

TUBULAR



P
Polido
Mirror polished
Pulido

.TB
PVD
Titanium
black

.TG
PVD
Titanium
gold

.TCO
PVD
Titanium
copper

.TCH
PVD
Titanium
chocolate

P
Polido
Mirror polished
Pulido

.TB
PVD
Titanium
black

.TG
PVD
Titanium
gold

.TCO
PVD
Titanium
copper

.TCH
PVD
Titanium
chocolate

IN.07.286.D.25

Asa de porta dupla para vidro /
Double door handle for glass /
Manillon de puerta doble para cristal.

+
IN.08.MFU.DV.25
Acessório para asa de porta dupla
para vidro / Accessory for double
glass door handle / Accesorio para
manillon de puerta doble de cristal.



MATERIAL: EN 1.4301 / AISI 304

ACABAMENTO / FINISH / ACABADO:
STANDARD: SATINADO / SATIN / SATIN

OPTIONAL: PVD TITANIUM COATED

.TB / .TG / .TCO / .TCH

A	B
250	400
300	450
450	600
600	750
900(**)	1050
1800(**)	1950
2000(**)	2150

(*) Acabamento em PVD titânio até 1000mm
/ PVD titanium finish until 1000mm / Acabado en
PVD titanio hasta 1000mm.

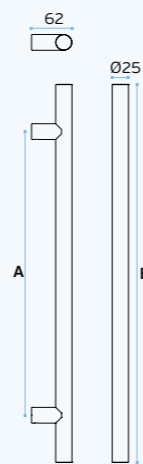

IN.08.MFU.SV.25

Acessório para asa de porta simples para vidro
Accessory for single glass door pull handle /
Accesorio para Manillon de puerta simple para
cristal.cristal.

TUBULAR



IN.07.286.D.30

Asa de porta dupla para vidro /
Double door handle for glass /
Manillon de puerta doble para cristal.

+
IN.08.MFU.DV.30
Acessório para asa de porta dupla
para vidro / Accessory for double
glass door handle / Accesorio para
manillon de puerta doble de cristal.



MATERIAL: EN 1.4301 / AISI 304

ACABAMENTO / FINISH / ACABADO:
STANDARD: SATINADO / SATIN / SATIN

OPTIONAL: PVD TITANIUM COATED

.TB / .TG / .TCO / .TCH

A	B
300	450
350	500
450	600
600	750
900(**)	1050
1200(**)	1350
1800(**)	1950
2000(**)	2150

(*) Acabamento em PVD titânio até 1000mm
/ PVD titanium finish until 1000mm / Acabado en
PVD titanio hasta 1000mm.

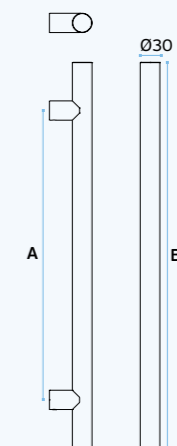

IN.08.MFU.SV.30

Acessório para asa de porta simples para vidro
Accessory for single glass door pull handle /
Accesorio para Manillon de puerta simple para
cristal.cristal.

TUBULAR

ASAS PARA PORTAS DE VIDRO / PULL HANDLES FOR GLASS DOORS / MANILLONES PARA PUERTAS DE CRISTAL.

IN.07.286.D.35

Asa de porta dupla para vidro /
Double door handle for glass /
Manillon de puerta doble para cristal.

+ IN.08.MFU.DV.35

Accessório para asa de porta dupla
para vidro / Accessory for double
glass door handle / Accesorio para
manillon de puerta doble de cristal.



MATERIAL: EN 1.4301 / AISI 304

ACABAMENTO / FINISH / ACABADO:
STANDARD: SATINADO / SATIN / SATIN

OPTIONAL: PVD TITANIUM COATED

.TB / .TG / .TCO / .TCH

A	B
350	500
450	600
600	750
900(*)	1050
1800(*)	1950
2000(*)	2150

(*) Acabamento em PVD titânio até 1000mm
/ PVD titanium finish until 1000mm / Acabado en
PVD titânio hasta 1000mm.

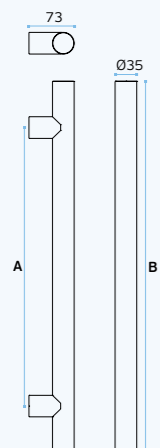

IN.08.MFU.SV.35

Accessório para asa de porta simples para vidro
Accessory for single glass door pull handle /
Accesorio para Manillon de puerta simple para
cristal.cristal.

TUBULAR

IN.07.286.D.40

Asa de porta dupla para vidro /
Double door handle for glass /
Manillon de puerta doble para cristal.

+ IN.08.MFU.DV.35

Accessório para asa de porta dupla
para vidro / Accessory for double
glass door handle / Accesorio para
manillon de puerta doble de cristal.



MATERIAL: EN 1.4301 / AISI 304

ACABAMENTO / FINISH / ACABADO:
STANDARD: SATINADO / SATIN / SATIN

OPTIONAL: PVD TITANIUM COATED

.TB / .TG / .TCO / .TCH

A	B
600	750
900(*)	1050
1800(*)	1950

(*) Acabamento em PVD titânio até 1000mm
/ PVD titanium finish until 1000mm / Acabado en
PVD titânio hasta 1000mm.

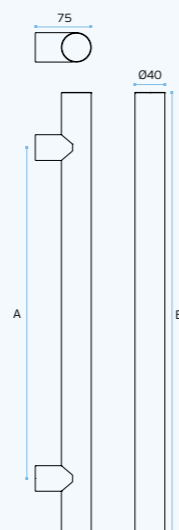

IN.08.MFU.SV.35

Accessório para asa de porta simples para vidro
Accessory for single glass door pull handle /
Accesorio para Manillon de puerta simple para
cristal.cristal.

TUBULAR

.P
Polido
Mirror polished
Pulido

.TB
PVD
Titanium
black

.TG
PVD
Titanium
gold

.TCO
PVD
Titanium
copper

.TCH
PVD
Titanium
chocolate

.P
Polido
Mirror polished
Pulido

.TB
PVD
Titanium
black

.TG
PVD
Titanium
gold

.TCO
PVD
Titanium
copper

.TCH
PVD
Titanium
chocolate



Bases ajustáveis.
Permite fazer
uma asa
modular, com
diferentes
distâncias entre
centros.

Adjustable feet.
Allows to create
a modular
door handle,
with different
distances
between centers.

Bases ajustables.
Permite crear
un manillon
modular, con
diferentes
distancias entre
los centros.

IN.07.310.D

Asa de porta dupla para vidro /
Double door handle for glass /
Manillon de puerta doble para cristal.

+ IN.08.MFU.DV.35

Accessório para asa de porta dupla
para vidro / Accessory for double
glass door handle / Accesorio para
manillon de puerta doble de cristal.



MATERIAL: EN 1.4301 / AISI 304

ACABAMENTO / FINISH / ACABADO:
STANDARD: SATINADO / SATIN / SATIN

OPTIONAL: PVD TITANIUM COATED

.TB / .TG / .TCO / .TCH

A	B
600	100-550
900	200-850
1250(*)	300-1200

(*) Acabamento em PVD titânio até 1000mm
/ PVD titanium finish until 1000mm / Acabado en
PVD titânio hasta 1000mm.



IN.08.MFU.SV.35

Accessório para asa de porta simples para vidro
Accessory for single glass door pull handle /
Accesorio para Manillon de puerta simple para
cristal.cristal.

TUBULAR



IN.07.126.D

Asa de porta dupla para vidro /
Double door handle for glass /
Manillon de puerta doble para cristal.

+ IN.08.MFU.DV.25

Accessório para asa de porta dupla
para vidro / Accessory for double
glass door handle / Accesorio para
manillon de puerta doble de cristal.



MATERIAL: EN 1.4301 / AISI 304

ACABAMENTO / FINISH / ACABADO:
STANDARD: SATINADO / SATIN / SATIN

OPTIONAL: PVD TITANIUM COATED

.TB / .TG / .TCO / .TCH

A	B
300	400
350	500
400	600
600	800

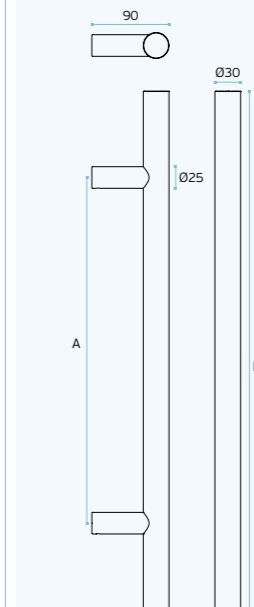

IN.08.MFU.SV.25

Accessório para asa de porta simples para vidro
Accessory for single glass door pull handle /
Accesorio para Manillon de puerta simple para
cristal.cristal.

TUBULAR



ASAS PARA PORTAS DE VIDRO / PULL HANDLES FOR GLASS DOORS / MANILLONES PARA PUERTAS DE CRISTAL.

IN.07.287.D.19

Asa de porta dupla para vidro /
 Double door handle for glass /
 Manillon de puerta doble para cristal.

IN.08.MFU.DV.19

Accessório para asa de porta dupla
 para vidro / Accessory for double
 glass door handle / Accesorio para
 manillon de puerta doble de cristal.



MATERIAL: EN 1.4301 / AISI 304

ACABAMENTO / FINISH / ACABADO:
 STANDARD: SATINADO / SATIN / SATIN

OPTIONAL: PVD TITANIUM COATED

.TB / .TG / .TCO / .TCH

A	B
200	219
250	269
300	319
350	369
425	444
600	619

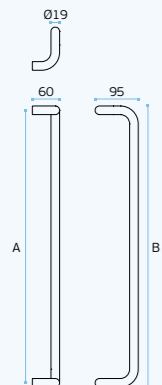

IN.08.MFU.SV.19

Accessório para asa de porta simples para vidro
 Accessory for single glass door pull handle /
 Accesorio para Manillon de puerta simple para
 cristal.cristal.

TUBULAR

IN.07.287.D.25

Asa de porta dupla para vidro /
 Double door handle for glass /
 Manillon de puerta doble para cristal.

IN.08.MFU.DV.25

Accessório para asa de porta dupla
 para vidro / Accessory for double
 glass door handle / Accesorio para
 manillon de puerta doble de cristal.



MATERIAL: EN 1.4301 / AISI 304

ACABAMENTO / FINISH / ACABADO:
 STANDARD: SATINADO / SATIN / SATIN

OPTIONAL: PVD TITANIUM COATED

.TB / .TG / .TCO / .TCH

A	B
300	325
350	375
425	450
600	625

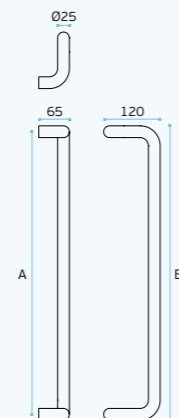

IN.08.MFU.SV.25

Accessório para asa de porta simples para vidro
 Accessory for single glass door pull handle /
 Accesorio para Manillon de puerta simple para
 cristal.cristal.

TUBULAR

.P
 Polido
 Mirror polished
 Pulido

.TB
 PVD
 Titanium
 black

.TG
 PVD
 Titanium
 gold

.TCO
 PVD
 Titanium
 copper

.TCH
 PVD
 Titanium
 chocolate

.P
 Polido
 Mirror polished
 Pulido

.TB
 PVD
 Titanium
 black

.TG
 PVD
 Titanium
 gold

.TCO
 PVD
 Titanium
 copper

.TCH
 PVD
 Titanium
 chocolate

IN.07.287.D.30

Asa de porta dupla para vidro /
 Double door handle for glass /
 Manillon de puerta doble para cristal.

IN.08.MFU.DV.30

Accessório para asa de porta dupla
 para vidro / Accessory for double
 glass door handle / Accesorio para
 manillon de puerta doble de cristal.



MATERIAL: EN 1.4301 / AISI 304

ACABAMENTO / FINISH / ACABADO:
 STANDARD: SATINADO / SATIN / SATIN

OPTIONAL: PVD TITANIUM COATED

.TB / .TG / .TCO / .TCH

A	B
250	330
350	380
425	455
600	630
1250(*)	1280

(*) Acabamento em PVD titânio até 1000mm
 / PVD titanium finish until 1000mm / Acabado en
 PVD titanio hasta 1000mm.

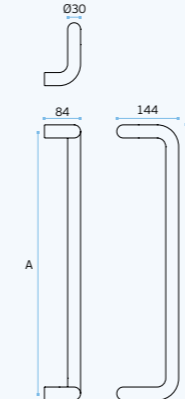

IN.08.MFU.SV.30

Accessório para asa de porta simples para vidro
 Accessory for single glass door pull handle /
 Accesorio para Manillon de puerta simple para
 cristal.cristal.

TUBULAR

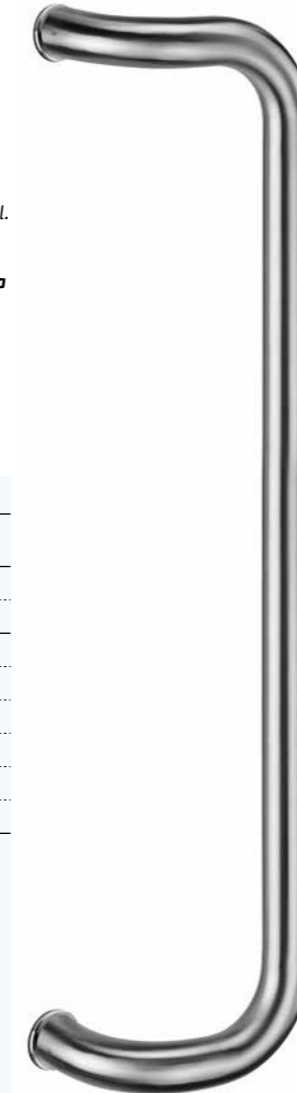

IN.07.287.D.35

Asa de porta dupla para vidro /
 Double door handle for glass /
 Manillon de puerta doble para cristal.

IN.08.MFU.DV.35

Accessório para asa de porta dupla
 para vidro / Accessory for double
 glass door handle / Accesorio para
 manillon de puerta doble de cristal.



MATERIAL: EN 1.4301 / AISI 304

ACABAMENTO / FINISH / ACABADO:
 STANDARD: SATINADO / SATIN / SATIN

OPTIONAL: PVD TITANIUM COATED

.TB / .TG / .TCO / .TCH

A	B
425	460
600	635
1250(*)	1285

(*) Acabamento em PVD titânio até 1000mm
 / PVD titanium finish until 1000mm / Acabado en
 PVD titanio hasta 1000mm.

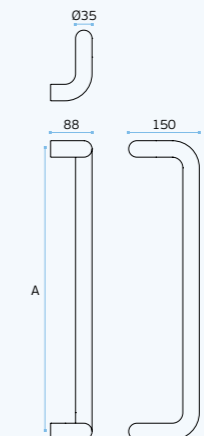

IN.08.MFU.SV.35

Accessório para asa de porta simples para vidro
 Accessory for single glass door pull handle /
 Accesorio para Manillon de puerta simple para
 cristal.cristal.

TUBULAR

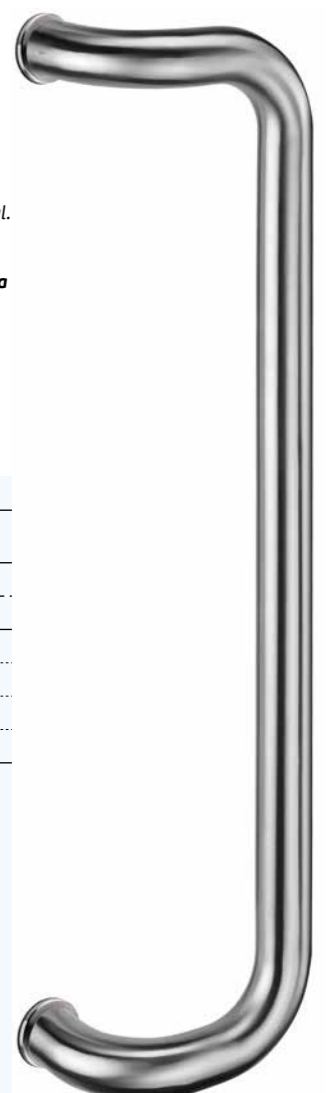

ASAS PARA PORTAS DE VIDRO / PULL HANDLES FOR GLASS DOORS / MANILLONES PARA PUERTAS DE CRISTAL.

IN.07.288.D .

Asa de porta dupla /
Double door handle /
Manillon de puerta doble.

+
IN.08.MFU.DV.19
Acessório para asa de porta dupla
para vidro / Accessory for double
glass door handle / Accesorio para
manillon de puerta doble de cristal.



MATERIAL: EN 1.4301 / AISI 304

ACABAMENTO / FINISH / ACABADO:
STANDARD: SATINADO / SATIN / SATIN

OPTIONAL: PVD TITANIUM COATED

.TB / .TG / .TCO / .TCH

A	B	C
Ø19	190	60
Ø25	215	63
Ø30	230	70

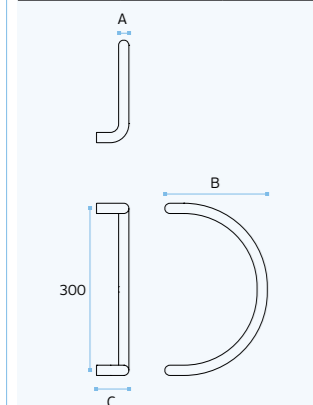

IN.08.MFU.SV.19
Acessório para asa de porta simples para vidro
Accessory for single glass door pull handle /
Accesorio para Manillon de puerta simple para
cristal.cristal.

TUBULAR



IN.07.288.D.19
+
IN.08.MFU.DV.19

TUBULAR

ACESSÓRIOS / ACCESSORIES

IN.08.MFU.DV.19
Dupla para vidro / double glass

IN.08.MFU.SV.19
Simples vidro / single glass

IN.07.288.D.25
+
IN.08.MFU.DV.19

TUBULAR

ACESSÓRIOS / ACCESSORIES

IN.08.MFU.DV.25
Dupla para vidro / double glass

IN.08.MFU.SV.25
Simples vidro / single glass

IN.07.288.D.30
+
IN.08.MFU.DV.19

TUBULAR

ACESSÓRIOS / ACCESSORIES

IN.08.MFU.DV.30
Dupla para vidro / double glass

IN.08.MFU.SV.30
Simples vidro / single glass

.P
Polido
Mirror polished
Pulido

.TB
PVD
Titanium
black

.TG
PVD
Titanium
gold

.TCO
PVD
Titanium
copper

.TCH
PVD
Titanium
chocolate

.P
Polido
Mirror polished
Pulido

.TB
PVD
Titanium
black

.TG
PVD
Titanium
gold

.TCO
PVD
Titanium
copper

.TCH
PVD
Titanium
chocolate

IN.07.008.D

Asa de porta dupla para vidro /
Double door handle for glass /
Manillon de puerta doble para cristal.

+
IN.08.MFU.DVQ.25
Acessório para asa de porta dupla
para vidro / Accessory for double
glass door handle / Accesorio para
manillon de puerta doble de cristal.



MATERIAL: EN 1.4301 / AISI 304

ACABAMENTO / FINISH / ACABADO:
STANDARD: SATINADO / SATIN / SATIN

OPTIONAL: PVD TITANIUM COATED

.TB / .TG / .TCO / .TCH

A	B
300	325
400	425

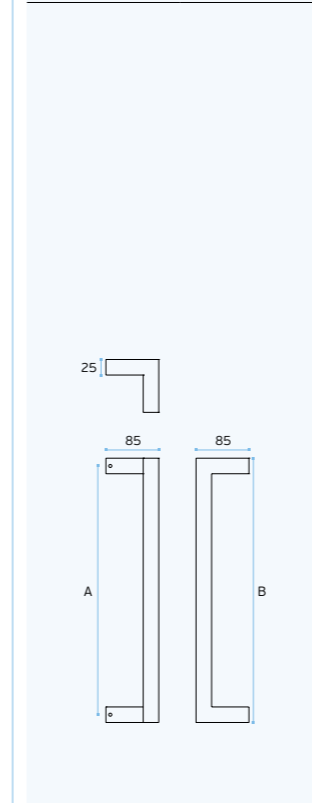

IN.08.MFU.SVQ.25

Acessório para asa de porta simples para vidro
Accessory for single glass door handle /
Accesorio para Manillon de puerta simple para
cristal.cristal.

TUBULAR



IN.07.297.D

Asa de porta dupla para vidro /
Double door handle for glass /
Manillon de puerta doble para cristal.

+
IN.08.MFU.DVR.38X25
Acessório para asa de porta dupla
para vidro / Accessory for double glass
door handle / Accesorio para manillon de
puerta doble de cristal.



MATERIAL: EN 1.4301 / AISI 304

ACABAMENTO / FINISH / ACABADO:
STANDARD: SATINADO / SATIN / SATIN

OPTIONAL: PVD TITANIUM COATED

.TB / .TG / .TCO / .TCH

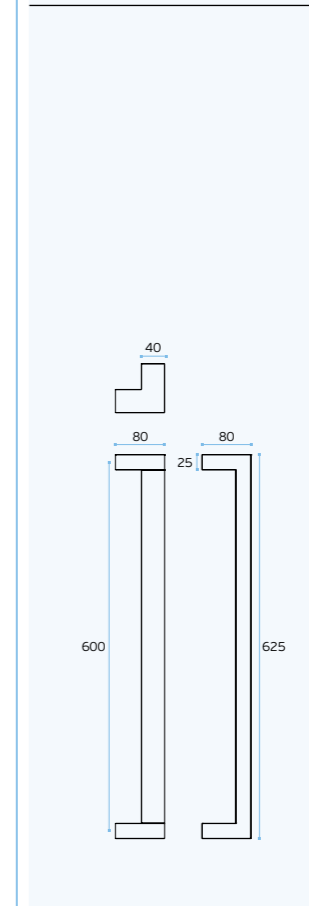

IN.08.MFU.SVR.38X25

Acessório para asa de porta simples para vidro
Accessory for single glass door handle /
Accesorio para Manillon de puerta simple para
cristal.cristal.

TUBULAR



ASAS PARA PORTAS DE VIDRO / PULL HANDLES FOR GLASS DOORS / MANILLONES PARA PUERTAS DE CRISTAL.

IN.07.011.D

Asa de porta dupla / Double door handle / Manillon de puerta doble.

.TB .TG .TCO .TCH

MATERIAL: EN 1.4301 / AISI 304

ACABAMENTO / FINISH / ACABADO: STANDARD: SATINADO / SATIN / SATIN

OPTIONAL: PVD TITANIUM COATED

.TB / .TG / .TCO / .TCH

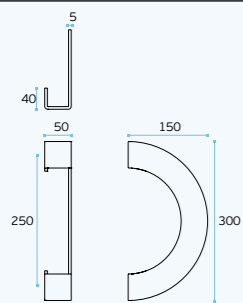

SOLID ■

ACESSÓRIOS / ACCESSORIES

■ AAM --- INCLUDED

PREPARADA PARA VIDRO / READY FOR GLASS



IN.07.012.D

Asa de porta dupla / Double door handle / Manillon de puerta doble.

.TB .TG .TCO .TCH

MATERIAL: EN 1.4301 / AISI 304

ACABAMENTO / FINISH / ACABADO: STANDARD: SATINADO / SATIN / SATIN

OPTIONAL: PVD TITANIUM COATED

.TB / .TG / .TCO / .TCH

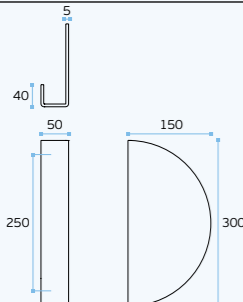

SOLID ■

ACESSÓRIOS / ACCESSORIES

■ AAM --- INCLUDED

PREPARADA PARA VIDRO / READY FOR GLASS



.P Polido Mirror polished Pulido

.TB PVD Titanium black

.TG PVD Titanium gold

.TCO PVD Titanium copper

.TCH PVD Titanium chocolate

.P Polido Mirror polished Pulido

.TB PVD Titanium black

.TG PVD Titanium gold

.TCO PVD Titanium copper

.TCH PVD Titanium chocolate

IN.07.501

Asa de porta simples para vidro / Single glass door handle / Manillon de puerta simple para cristal.

IN.07.501.D

Asa de porta dupla / Double door handle / Manillon de puerta doble.

.TB .TG .TCO .TCH

MATERIAL: EN 1.4301 / AISI 304

ACABAMENTO / FINISH / ACABADO: STANDARD: SATINADO / SATIN / SATIN

OPTIONAL: PVD TITANIUM COATED

.TB / .TG / .TCO / .TCH

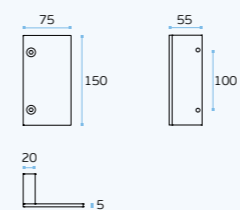

SOLID ■

ACESSÓRIOS / ACCESSORIES

■ MFU M6 --- INCLUDED

PREPARADA PARA VIDRO / READY FOR GLASS



IN.07.500

Asa de porta simples para vidro / Single glass door handle / Manillon de puerta simple para cristal.

IN.07.500.D

Asa de porta dupla / Double door handle / Manillon de puerta doble.

.TB .TG .TCO .TCH

MATERIAL: EN 1.4301 / AISI 304

ACABAMENTO / FINISH / ACABADO: STANDARD: SATINADO / SATIN / SATIN

OPTIONAL: PVD TITANIUM COATED

.TB / .TG / .TCO / .TCH

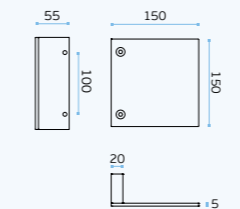

SOLID ■

ACESSÓRIOS / ACCESSORIES

■ MFU M6 --- INCLUDED

PREPARADA PARA VIDRO / READY FOR GLASS



A

Acessórios para asas de porta / Accessories for pull handles / Accesorios para manillones

Adaptadores com formas especiais / Special shapes adapters / Adaptadores con formas especiales

IN.08.MFU.DV.____

Jogo de adaptadores para asa dupla para porta de vidro. Para portas com espessura até 30mm. Aplicável em asas com base redonda / Set of fittings for doors with back to back fixing. For glass doors with thickness till 30mm. Applicable in pull handles with round base / Juego de adaptadores para manillon double para puertas. Para puertas de cristal con espesor hasta 30mm. Aplicable en manillones con base redonda.

COMPATIBILIDADE COM ASAS POR REFERÊNCIA / PULL HANDLE REFERENCE COMPATIBILITY / COMPATIBILIDAD CON TIRADORES POR REFERENCIA:

Ø16	Ø19	Ø22	Ø25	Ø30	Ø35
IN.07.204.16 IN.07.207.16	IN.07.003 IN.07.004 IN.07.418 IN.07.123 IN.07.143 IN.07.204.19 IN.07.207.19 IN.07.281 IN.07.281.SD IN.07.286.20 IN.07.287.19 MV.07.030	IN.07.409 IN.07.418 IN.07.412	IN.07.141 IN.07.031 IN.07.125 IN.07.185 IN.07.187 IN.07.204.25 IN.07.207.25 IN.07.286.25 IN.07.287.25 IN.07.288.25 IN.07.289.25 IN.07.293 IN.07.177 IN.07.179	IN.07.204.30 IN.07.207.30 IN.07.286.30 IN.07.287.30 IN.07.288.30 IN.07.289.30 IN.07.291 IN.07.292	IN.07.204.35 IN.07.207.35 IN.07.286.35 IN.07.286.40 IN.07.287.35 IN.07.289.35 IN.07.290 IN.07.310

Furação do vidro / Glass hole / Talladro en cristal

Ø10	Ø10	Ø10	Ø12	Ø12	Ø12
-----	-----	-----	-----	-----	-----

IN.08.MFU.SV.____

Jogo de adaptadores para asa simples para porta. Para portas de vidro com espessura até 30mm / Set of fittings for doors with single fixing. For glass doors with thickness till 30mm / Juego de adaptadores para manillon simples para puertas de cristal. Para puertas con espesor hasta 30mm.

COMPATIBILIDADE COM ASAS POR REFERÊNCIA / PULL HANDLE REFERENCE COMPATIBILITY / COMPATIBILIDAD CON TIRADORES POR REFERENCIA:

Ø16	Ø19	Ø22	Ø25	Ø30	Ø35
IN.07.204.16 IN.07.207.16	IN.07.003 IN.07.004 IN.07.143 IN.07.204.19 IN.07.207.19 IN.07.281 IN.07.281.SD IN.07.286.20 IN.07.287.19	IN.07.409 IN.07.418 IN.07.412	IN.07.141 IN.07.031 IN.07.125 IN.07.185 IN.07.187 IN.07.204.25 IN.07.207.25 IN.07.286.25 IN.07.287.25 IN.07.288.25 IN.07.289.25 IN.07.293 IN.07.177 IN.07.179	IN.07.204.30 IN.07.207.30 IN.07.286.30 IN.07.287.30 IN.07.288.30 IN.07.289.30 IN.07.291 IN.07.292	IN.07.204.35 IN.07.207.35 IN.07.286.35 IN.07.286.40 IN.07.287.35 IN.07.289.35 IN.07.290 IN.07.310

Furação do vidro / Glass hole / Talladro en cristal

Ø10	Ø10	Ø10	Ø12	Ø12	Ø12
-----	-----	-----	-----	-----	-----

IN.08.MFU.SVQ.____

Jogo de adaptadores para asa simples para porta de vidro. Para portas com espessura até 40mm. Aplicável em asas com base quadrada / Set of fittings for doors with single fixing. For glass doors with thickness till 40mm. Applicable in pull handles with square base / Juego de adaptadores para manillon simples para puertas. Para puertas de cristal con espesor hasta 40mm. Aplicable en manillones con base cuadrada.

COMPATIBILIDADE COM ASAS POR REFERÊNCIA / PULL HANDLE REFERENCE COMPATIBILITY / COMPATIBILIDAD CON TIRADORES POR REFERENCIA:

16	25	25.R	30
16x16 IN.07.002.16	25x25 IN.07.008.D IN.07.200.25	25x25 IN.07.178	30x30 IN.07.142 IN.07.152 IN.07.153

Furação do vidro / Glass hole / Talladro en cristal

Ø10	Ø10	Ø10	Ø12	Ø12	Ø12
-----	-----	-----	-----	-----	-----

IN.08.MFU.DVO.____

Jogo de adaptadores para asa dupla para porta de vidro. Para portas com espessura até 40mm. Aplicável em asas com base oval / Set of fittings for doors with back to back fixing. For glass doors with thickness till 40mm. Applicable in pull handles with oval base / Juego de adaptadores para manillon double para puertas. Para puertas de cristal con espesor hasta 40mm. Aplicable en manillones con base oval.

COMPATIBILIDADE COM ASAS POR REFERÊNCIA / PULL HANDLE REFERENCE COMPATIBILITY / COMPATIBILIDAD CON TIRADORES POR REFERENCIA:

Ø02	Ø295
IN.07.002	IN.07.295

IN.08.MFU.SVO.____

Jogo de adaptadores para asa simples para porta de vidro. Para portas com espessura até 40mm. Aplicável em asas com base oval / Set of fittings for glass doors with single fixing. For doors with thickness till 40 mm. Applicable in pull handles with oval base / Juego de adaptadores para manillon simples para puertas de cristal. Para puertas con espesor hasta 40mm. Aplicable en manillones con base oval.

COMPATIBILIDADE COM ASAS POR REFERÊNCIA / PULL HANDLE REFERENCE COMPATIBILITY / COMPATIBILIDAD CON TIRADORES POR REFERENCIA:

Ø02	Ø295
IN.07.002	IN.07.295

IN.08.MFU.DVR.____x____

Jogo de adaptadores para asa dupla para porta. Para portas de vidro com espessura até 40mm. Aplicável em asas com base retangular / Set of fittings for doors with back to back fixing. For glass doors with thickness till 40 mm. Applicable in pull handles with rectangular base / Juego de adaptadores para manillon double para puertas. Para puertas de cristal con espesor hasta 40mm. Aplicable en manillones con base rectangular.

COMPATIBILIDADE COM ASAS POR REFERÊNCIA / PULL HANDLE REFERENCE COMPATIBILITY / COMPATIBILIDAD CON TIRADORES POR REFERENCIA:

16x32	36x23	40x20	38x25
IN.07.296	IN.07.006	IN.07.005	IN.07.297

IN.08.MFU.SVR.____x____

Jogo de adaptadores para asa simples para porta. Para portas de vidro com espessura até 40mm. Aplicável em asas com base retangular / Set of fittings for doors with single fixing. For glass doors with thickness till 40 mm. Applicable in pull handles with rectangular base / Juego de adaptadores para manillon simples para puertas. Para puertas de cristal con espesor hasta 40mm. Aplicable en manillones con base rectangular.

COMPATIBILIDADE COM ASAS POR REFERÊNCIA / PULL HANDLE REFERENCE COMPATIBILITY / COMPATIBILIDAD CON TIRADORES POR REFERENCIA:

16x32	36x23	40x20	38x25
IN.07.296	IN.07.006	IN.07.005	IN.07.297

IN.08.MFU.SVR.____x____

Jogo de adaptadores para asa simples para porta. Para portas de vidro com espessura até 40mm. Aplicável em asas com base retangular / Set of fittings for doors with single fixing. For glass doors with thickness till 40 mm. Applicable in pull handles with rectangular base / Juego de adaptadores para manillon simples para puertas. Para puertas de cristal con espesor hasta 40mm. Aplicable en manillones con base rectangular.

COMPATIBILIDADE COM ASAS POR REFERÊNCIA / PULL HANDLE REFERENCE COMPATIBILITY / COMPATIBILIDAD CON TIRADORES POR REFERENCIA:

16x32	36x23	40x20	38x25
IN.07.296	IN.07.006	IN.07.005	IN.07.297

IN.08.MFU.SVR.____x____

Jogo de adaptadores para asa simples para porta. Para portas de vidro com espessura até 40mm. Aplicável em asas com base retangular / Set of fittings for doors with single fixing. For glass doors with thickness till 40 mm. Applicable in pull handles with rectangular base / Juego de adaptadores para manillon simples para puertas. Para puertas de cristal con espesor hasta 40mm. Aplicable en manillones con base rectangular.

COMPATIBILIDADE COM ASAS POR REFERÊNCIA / PULL HANDLE REFERENCE COMPATIBILITY / COMPATIBILIDAD CON TIRADORES POR REFERENCIA:

16x32	36x23	40x20	38x25
IN.07.296	IN.07.006	IN.07.005	IN.07.297

CONCHAS PARA VIDRO / FLUSH HANDLES FOR GLASS / CAZOLETAS PARA CRISTAL.

FLUSH HANDLES FOR GLASS DOORS

CONCHAS PARA PORTAS DE CORRER
PRODUZIDAS EM AÇO INOXIDÁVEL SÓLIDO
COM 5MM DE ESPESSURA, PROJETADAS PARA
SEREM COLADAS AO VIDRO. PRODUZIDO
COM ESPECIAL ATENÇÃO PARA TORNÁ-LAS
COMPLETAMENTE PLANAS PARA ADERIR AO
VIDRO, MAS SIMULTANEAMENTE CONFORTÁVEIS.
FORNECIDO COM ADESIVO 3M, FIXAÇÃO
PERMANENTE E RÁPIDA COM ALTA RESISTÊNCIA
E DURABILIDADE AO LONGO DO TEMPO.

FLUSH HANDLES FOR SLIDING DOORS MADE IN
SOLID STAINLESS STEEL WITH 5MM THICKNESS,
DESIGNED TO BE GLUED TO GLASS. PRODUCED WITH
SPECIAL CARE TO MAKE THEM FLAT TO STICK TO
THE GLASS BUT SIMULTANEOUSLY SMOOTH TO BE
OPERATED WITHOUT HARMING THE FINGERS OF THE
USER. SUPPLIED WITH 3M ADHESIVE, PERMANENT
AND QUICK FIXING WITH HIGH RESISTANCE AND
DURABILITY WITH TIME.

CAZOLETAS PARA PUERTAS CORREDERAS HECHAS
DE ACERO INOXIDABLE SÓLIDO CON UN GROSOR
DE 5 MM, DISEÑADAS PARA SER PEGADAS AL
CRISTAL. PRODUCIDO CON ESPECIAL CUIDADO
PARA HACERLOS PLANOS PARA PEGARSE AL
CRISTAL, PERO AL MISMO TIEMPO SUAVES PARA SER
OPERADOS SIN DAÑAR LOS DEDOS DEL USUARIO.
SUMINISTRADO CON ADHESIVO 3M, FIJACIÓN
PERMANENTE Y RÁPIDA CON ALTA RESISTENCIA Y
DURABILIDAD CON EL TIEMPO.



IN.16.550.A
Concha para vidro
(Com adesivo 3M) /
Flush handle for glass
(With 3M adhesive) /
Cazoleta para cristal
(Con pegatina 3M).

MATERIAL:
EN 1.4301 / AISI 304
ACABAMENTO /
FINISH / ACABADO:
SATINADO / SATIN



IMAGEM / IMAGE:
2x: IN.16.550.A

IN.16.551.A
Concha para vidro
(Com adesivo 3M) /
Flush handle for glass
(With 3M adhesive) /
Cazoleta para cristal
(Con pegatina 3M).

MATERIAL:
EN 1.4301 / AISI 304
ACABAMENTO /
FINISH / ACABADO:
SATINADO / SATIN

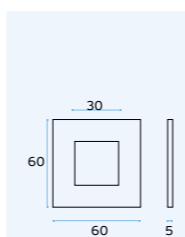

IMAGEM / IMAGE:
2x: IN.16.551.A

IN.16.552.A
Concha para vidro
(Com adesivo 3M) /
Flush handle for glass
(With 3M adhesive) /
Cazoleta para cristal
(Con pegatina 3M).

MATERIAL:
EN 1.4301 / AISI 304
ACABAMENTO /
FINISH / ACABADO:
SATINADO / SATIN

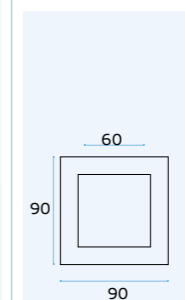

IMAGEM / IMAGE:
2x: IN.16.552.A

IN.16.553.A
Concha para vidro
(Com adesivo 3M) /
Flush handle for glass
(With 3M adhesive) /
Cazoleta para cristal
(Con pegatina 3M).

MATERIAL:
EN 1.4301 / AISI 304
ACABAMENTO /
FINISH / ACABADO:
SATINADO / SATIN

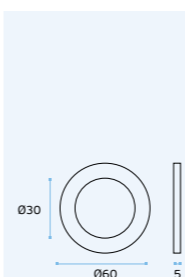

IMAGEM / IMAGE:
2x: IN.16.553.A

CONCHAS PARA VIDRO / FLUSH HANDLES FOR GLASS / CAZOLETAS PARA CRISTAL.

IN.16.554.A
Concha para vidro
(Com adesivo 3M) /
Flush handle for glass
(With 3M adhesive) /
Cazoleta para cristal
(Con pegatina 3M).

MATERIAL:
EN 1.4301 / AISI 304
ACABAMENTO /
FINISH / ACABADO:
SATINADO / SATIN

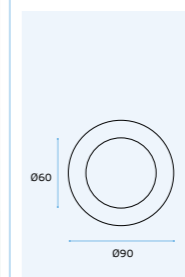

IMAGEM / IMAGE:
2x: IN.16.554.A

IN.16.555.A
Concha para vidro
(Com adesivo 3M) /
Flush handle for glass
(With 3M adhesive) /
Cazoleta para cristal
(Con pegatina 3M).

MATERIAL:
EN 1.4301 / AISI 304
ACABAMENTO /
FINISH / ACABADO:
SATINADO / SATIN

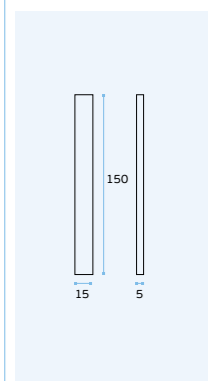

IMAGEM / IMAGE:
2x: IN.16.555.A

IN.16.558.A
Concha para vidro
(Com adesivo 3M) /
Flush handle for glass
(With 3M adhesive) /
Cazoleta para cristal
(Con pegatina 3M).

MATERIAL:
EN 1.4301 / AISI 304
ACABAMENTO /
FINISH / ACABADO:
SATINADO / SATIN

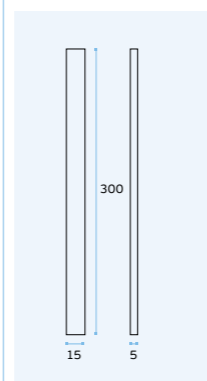

IMAGEM / IMAGE:
2x: IN.16.558.A

IN.16.559.A
Concha para vidro
(Com adesivo 3M) /
Flush handle for glass
(With 3M adhesive) /
Cazoleta para cristal
(Con pegatina 3M).

MATERIAL:
EN 1.4301 / AISI 304
ACABAMENTO /
FINISH / ACABADO:
SATINADO / SATIN

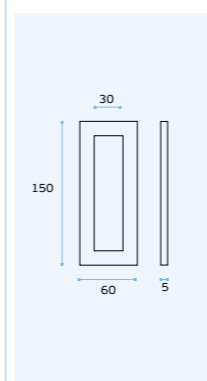

IMAGEM / IMAGE:
2x: IN.16.559.A

IN.16.556.A
Concha para vidro
(Com adesivo 3M) /
Flush handle for glass
(With 3M adhesive) /
Cazoleta para cristal
(Con pegatina 3M).

MATERIAL:
EN 1.4301 / AISI 304
ACABAMENTO /
FINISH / ACABADO:
SATINADO / SATIN

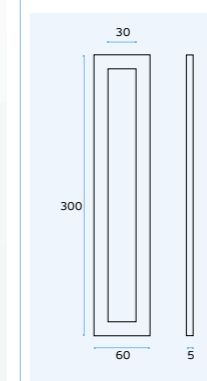

IMAGEM / IMAGE:
2x: IN.16.556.A

IN.16.557.A
Concha para vidro
(Com adesivo 3M) /
Flush handle for glass
(With 3M adhesive) /
Cazoleta para cristal
(Con pegatina 3M).

MATERIAL:
EN 1.4301 / AISI 304
ACABAMENTO /
FINISH / ACABADO:
SATINADO / SATIN

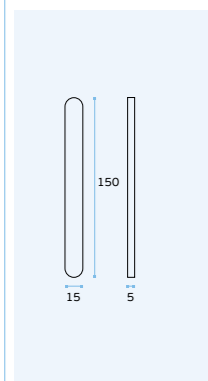

IMAGEM / IMAGE:
2x: IN.16.557.A

IN.16.560.A
Concha para vidro
(Com adesivo 3M) /
Flush handle for glass
(With 3M adhesive) /
Cazoleta para cristal
(Con pegatina 3M).

MATERIAL:
EN 1.4301 / AISI 304
ACABAMENTO /
FINISH / ACABADO:
SATINADO / SATIN

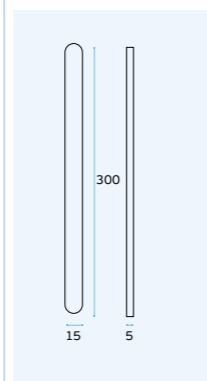

IMAGEM / IMAGE:
2x: IN.16.560.A

IN.16.561.A
Concha para vidro
(Com adesivo 3M) /
Flush handle for glass
(With 3M adhesive) /
Cazoleta para cristal
(Con pegatina 3M).

MATERIAL:
EN 1.4301 / AISI 304
ACABAMENTO /
FINISH / ACABADO:
SATINADO / SATIN

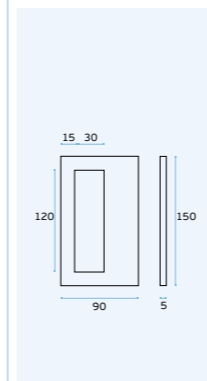

IMAGEM / IMAGE:
2x: IN.16.561.A

CONCHAS PARA VIDRO / FLUSH HANDLES FOR GLASS / CAZOLETAS PARA CRISTAL.

IN.16.562.A
Concha para vidro
(Com adesivo 3M) /
Flush handle for glass
(With 3M adhesive) /
Cazoleta para cristal
(Con pegatina 3M).

MATERIAL:
EN 1.4301 / AISI 304
**ACABAMENTO /
FINISH / ACABADO:**
SATINADO / SATIN

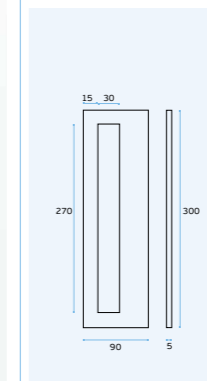

IMAGEM / IMAGE:
2x: IN.16.562.A

IN.16.563.A
Concha para vidro
(Com adesivo 3M) /
Flush handle for glass
(With 3M adhesive) /
Cazoleta para cristal
(Con pegatina 3M).

MATERIAL:
EN 1.4301 / AISI 304
**ACABAMENTO /
FINISH / ACABADO:**
SATINADO / SATIN

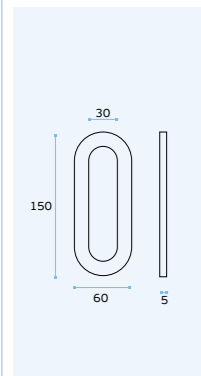

IMAGEM / IMAGE:
2x: IN.16.563.A

IN.16.566.A
Concha para vidro
(Com adesivo 3M) /
Flush handle for glass
(With 3M adhesive) /
Cazoleta para cristal
(Con pegatina 3M).

MATERIAL:
EN 1.4301 / AISI 304
**ACABAMENTO /
FINISH / ACABADO:**
SATINADO / SATIN

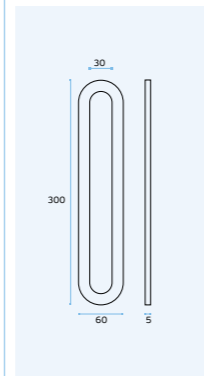

IMAGEM / IMAGE:
2x: IN.16.566.A

IN.16.567.A
Concha para vidro
(Com adesivo 3M) /
Flush handle for glass
(With 3M adhesive) /
Cazoleta para cristal
(Con pegatina 3M).

MATERIAL:
EN 1.4301 / AISI 304
**ACABAMENTO /
FINISH / ACABADO:**
SATINADO / SATIN

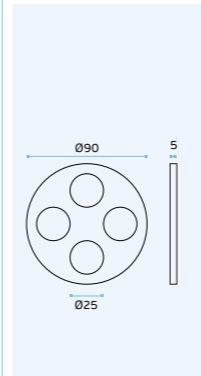

IMAGEM / IMAGE:
2x: IN.16.567.A

IN.16.564.A
Concha para vidro
(Com adesivo 3M) /
Flush handle for glass
(With 3M adhesive) /
Cazoleta para cristal
(Con pegatina 3M).

MATERIAL:
EN 1.4301 / AISI 304
**ACABAMENTO /
FINISH / ACABADO:**
SATINADO / SATIN

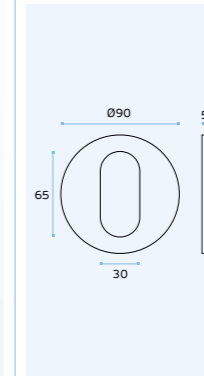

IMAGEM / IMAGE:
2x: IN.16.564.A

IN.16.565.A
Concha para vidro
(Com adesivo 3M) /
Flush handle for glass
(With 3M adhesive) /
Cazoleta para cristal
(Con pegatina 3M).

MATERIAL:
EN 1.4301 / AISI 304
**ACABAMENTO /
FINISH / ACABADO:**
SATINADO / SATIN

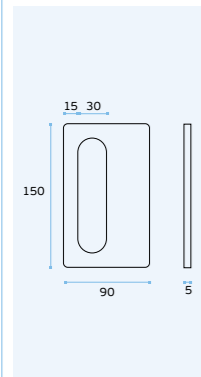

IMAGEM / IMAGE:
2x: IN.16.565.A

IN.16.527
Concha para vidro
(Com adesivo 3M) /
Flush handle for glass
(With 3M adhesive) /
Cazoleta para cristal
(Con pegatina 3M).

MATERIAL:
EN 1.4301 / AISI 304
**ACABAMENTO /
FINISH / ACABADO:**
SATINADO / SATIN

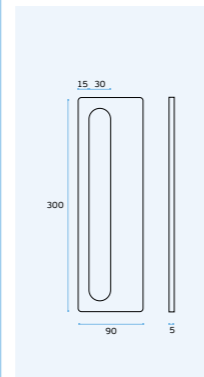

IMAGEM / IMAGE:
2x: IN.16.527

IN.16.528
Concha para vidro
(Com adesivo 3M) /
Flush handle for glass
(With 3M adhesive) /
Cazoleta para cristal
(Con pegatina 3M).

MATERIAL:
EN 1.4301 / AISI 304
**ACABAMENTO /
FINISH / ACABADO:**
SATINADO / SATIN

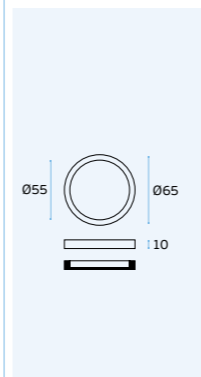

IMAGEM / IMAGE:
2x: IN.16.528

SISTEMAS DE FIXAÇÃO PARA VIDRO /
SUPPORT SYSTEMS FOR GLASS /
SISTEMAS DE FIJACIÓN PARA CRISTAL.

IN.75.017
IN.75.022
Suporte para vidro /
Glass connector /
Soporte para cristal.

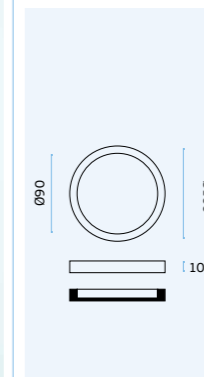

GC98
8-12 mm
glass cut

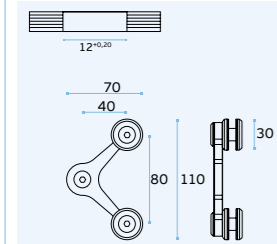

MATERIAL: EN 1.4301 / AISI 304
ACABAMENTO / FINISH / ACABADO:
STANDARD: SATINADO / SATIN / SATIN

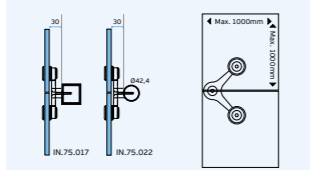

IN.75.018
IN.75.023
Suporte para vidro /
Glass connector /
Soporte para cristal.



GC99
8-12 mm
glass cut

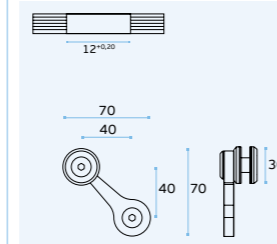

MATERIAL: EN 1.4301 / AISI 304
ACABAMENTO / FINISH / ACABADO:
STANDARD: SATINADO / SATIN / SATIN

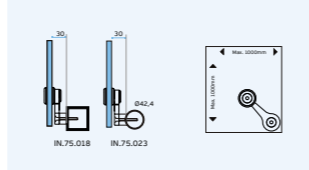

IN.75.015
Suporte para vidro /
Glass connector /
Soporte para cristal.



GC96
8-12 mm
glass cut

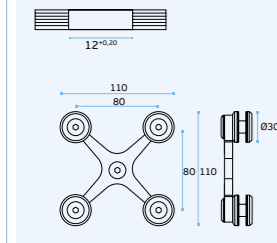

MATERIAL: EN 1.4301 / AISI 304
ACABAMENTO / FINISH / ACABADO:
STANDARD: SATINADO / SATIN / SATIN

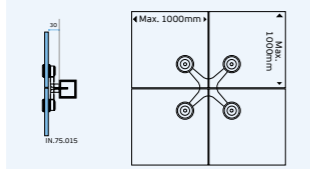

IN.75.014
Suporte para vidro /
Glass connector /
Soporte para cristal.



GC96
8-12 mm
glass cut

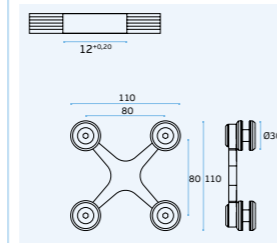

MATERIAL: EN 1.4301 / AISI 304
ACABAMENTO / FINISH / ACABADO:
STANDARD: SATINADO / SATIN / SATIN

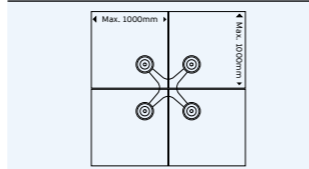

IN.75.020
Suporte para vidro /
Glass connector /
Soporte para cristal.



GC96
8-12 mm
glass cut

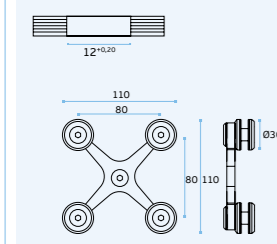

MATERIAL: EN 1.4301 / AISI 304
ACABAMENTO / FINISH / ACABADO:
STANDARD: SATINADO / SATIN / SATIN

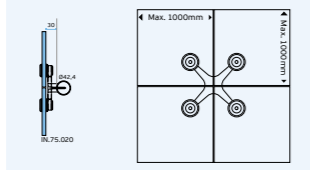

IN.75.016
IN.75.021
Suporte para vidro /
Glass connector /
Soporte para cristal.



GC97
8-12 mm
glass cut

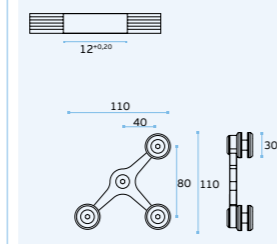

MATERIAL: EN 1.4301 / AISI 304
ACABAMENTO / FINISH / ACABADO:
STANDARD: SATINADO / SATIN / SATIN

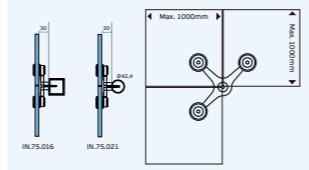

SPIDER CONNECTORS

SISTEMA DE FIXADORES PARA VIDROS
DESENVOLVIDO PARA USO NO INTERIOR /
GLASS CONNECTOR SYSTEM
DEVELOPED FOR INDOOR USE /
SISTEMA DE FIJACIÓN DE CRISTAL
DESARROLLADO PARA USO EN INTERIORES.



SISTEMAS DE FIXAÇÃO PARA VIDRO / SUPPORT SYSTEMS FOR GLASS / SISTEMAS DE FIJACIÓN PARA CRISTAL.



IN.82.001
Suporte para vidro com acessórios /
Glass connector with accessories /
Soporte para cristal con accesorios.



IN.82.002
Suporte para vidro com acessórios /
Glass connector with accessories /
Soporte para cristal con accesorios.

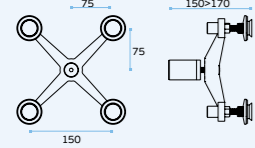

MATERIAL: EN 1.4301 / AISI 304
ACABAMENTO / FINISH / ACABADO:
STANDARD: SATINADO / SATIN / SATIN

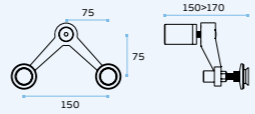
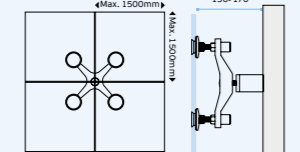

MATERIAL: EN 1.4301 / AISI 304
ACABAMENTO / FINISH / ACABADO:
STANDARD: SATINADO / SATIN / SATIN

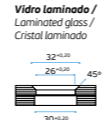
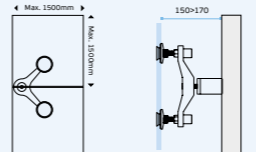

IN.82.003
Suporte para vidro com acessórios /
Glass connector with accessories /
Soporte para cristal con accesorios.



IN.82.004
Suporte para vidro com acessórios /
Glass connector with accessories /
Soporte para cristal con accesorios.

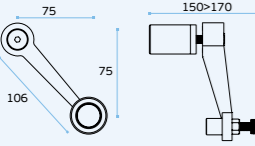

MATERIAL: EN 1.4301 / AISI 304
ACABAMENTO / FINISH / ACABADO:
STANDARD: SATINADO / SATIN / SATIN

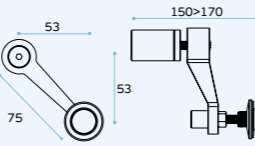
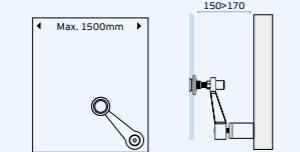

MATERIAL: EN 1.4301 / AISI 304
ACABAMENTO / FINISH / ACABADO:
STANDARD: SATINADO / SATIN / SATIN

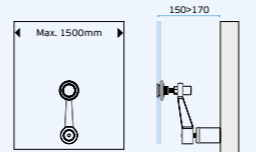

IN.82.005
Suporte para vidro com acessórios /
Glass connector with accessories /
Soporte para cristal con accesorios.



IN.82.006
Suporte para vidro com acessórios /
Glass connector with accessories /
Soporte para cristal con accesorios.

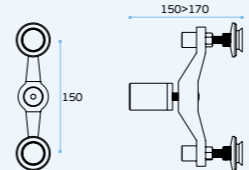

MATERIAL: EN 1.4301 / AISI 304
ACABAMENTO / FINISH / ACABADO:
STANDARD: SATINADO / SATIN / SATIN

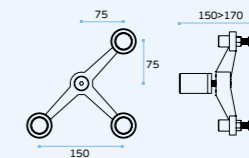
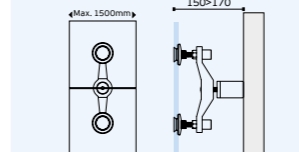

MATERIAL: EN 1.4301 / AISI 304
ACABAMENTO / FINISH / ACABADO:
STANDARD: SATINADO / SATIN / SATIN

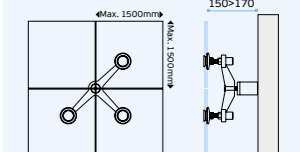

SISTEMAS DE FIXAÇÃO PARA VIDRO / SUPPORT SYSTEMS FOR GLASS / SISTEMAS DE FIJACIÓN PARA CRISTAL.

IN.80.902

Suporte para vidro com acessórios /
Glass connector with accessories /
Soporte para cristal con accesorios.

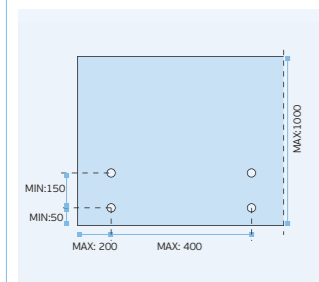

MATERIAL: EN 1.4401 / AISI 316

ACABAMENTO / FINISH / ACABADO:
STANDARD: SATINADO / SATIN

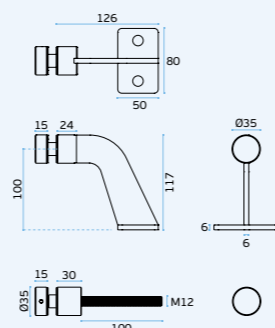

IN.80.902.TB
Titanium Black



IN.80.902.TG
Titanium Gold



IN.80.902.TCO
Titanium Copper



IN.80.902.TCH
Titanium Chocolate



SLAB GLASS HOLDERS

ESTE SISTEMA FOI DESENVOLVIDO PARA A ARQUITETURA CONTEMPORÂNEA, ONDE AS LAJES DE BETÃO SÃO PARTE INTEGRANTE. OS SUPORTES DE VIDRO USAM A LAJE QUE CRIA A VARANDA, AGARRANDO A SUPERFÍCIE SUPERIOR E FRONTAL, GARANTINDO ASSIM A SEGURANÇA E A LIMPEZA DO VIDRO DA VARANDA, DEIXANDO O ALÇADO FRONTAL CONFORME PROJETADO PELO ARQUITETO /

THIS SYSTEM WAS DEVELOPED FOR THE CONTEMPORARY ARCHITECTURE, WHERE THE CONCRETE SLABS ARE PART OF IT. THE GLASS HOLDERS USE THE SLAB THAT CREATES THE BALCONY AND GRAB THEM USING THE UPPER AND FRONT SURFACE, GUARANTEE SIMULTANEOUSLY THE SECURITY AND THE CLEAN GLASS OF THE BALCONY, LEAVING FRONT ELEVATION AS DESIGNED BY THE ARCHITECT.

ESTE SISTEMA FUE DESARROLLADO PARA LA ARQUITECTURA CONTEMPORÂNEA, DONDE LAS LOSAS DE HORMIGÓN SON UNA PARTE INTEGRAL. LOS SOPORTES DE CRISTAL UTILIZAN LA LOSA QUE CREA EL BalcÓN Y AGARRANDO LA SUPERFICIE SUPERIOR Y FRONTAL, GARANTIZANDO AL MISMO TIEMPO LA SEGURIDAD Y LA LIMPIEZA DEL CRISTAL DEL BalcÓN, DEJANDO EL ALZADO FRONTAL SEGÚN LO DISEÑADO POR EL ARQUITECTO.

SISTEMAS DE FIXAÇÃO PARA VIDRO / SUPPORT SYSTEMS FOR GLASS / SISTEMAS DE FIJACIÓN PARA CRISTAL.

IN.80.800

Suporte para vidro. Fixação à parede / Glass support. Wall fixing / Soporte para cristal. Sujeción a pared.

.TB .TG .TCO .TCH

GC106 glass cut
10-25 mm
60 kg
INT EXT

MATERIAL: EN 1.4301 / AISI 304

ACABAMENTO / FINISH / ACABADO:
STANDARD: SATINADO / SATIN / SATIN

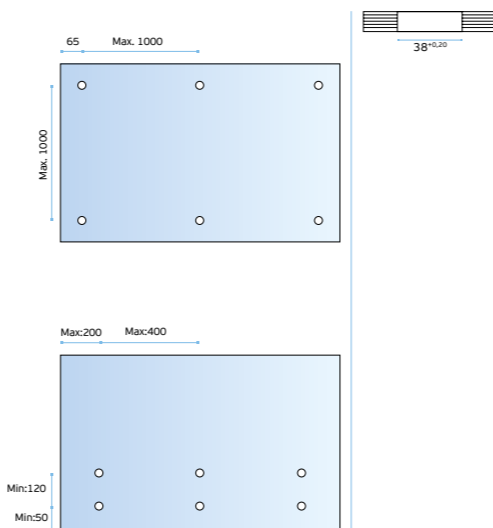
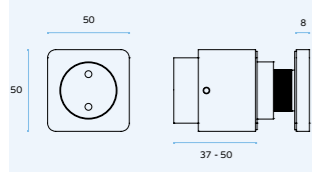

Base de fixação robusta, permite carga máxima de 60kg por suporte /

Strong fixing base allows maximum weight 60kg per support / Base fuerte de fijación, permite peso máximo de 60kg por soporte.

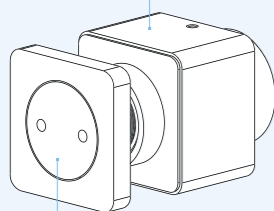

Parafuso antivandalismo de aperto do vidro / Antivandalism screw to fix the glass / Tornillo anti vandalismo para fijar el cristal.

Espessura do vidro / Glass thickness / Espesor del cristal. 10-25mm

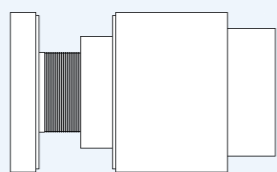

Ajuste de profundidade / Deep adjustment / Ajuste de profundidad. 37-50mm

Parafuso para bloqueio dos ajustes / Screw to lock the adjustments / Tornillo para bloqueo de ajustes.

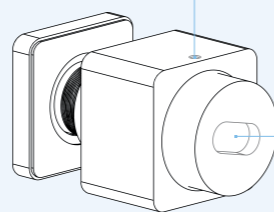

Ajuste em largura e altura / Height and length adjustment / Ajuste en altura y anchura.

IN.80.801

Suporte para vidro. Fixação à parede / Glass support. Wall fixing / Soporte para cristal. Sujeción a pared.

.TB .TG .TCO .TCH

GC101 glass cut
10-25 mm
60 kg
INT EXT

MATERIAL: EN 1.4301 / AISI 304

ACABAMENTO / FINISH / ACABADO:
STANDARD: SATINADO / SATIN / SATIN

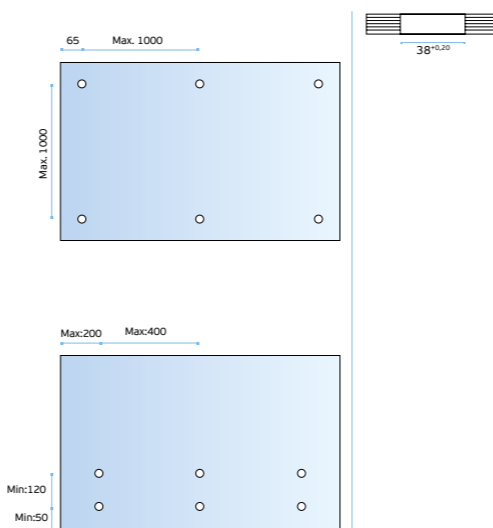
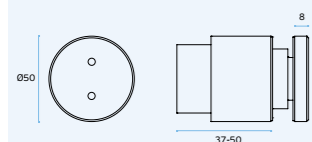

GLASS STANDOFF

A JNF desenvolveu diferentes tipos de afastadores de vidro para as múltiplas solicitações. A estética é um ponto, em pode ser redonda ou quadrada, mas também o acabamento pode ser satinado ou titânio pvd com cores preto, dourado, cobre ou chocolate. Tecnicamente diferentes tipos e espessuras de vidro foram contemplados e também diferentes afastamentos para a parede, em alguns modelos ajustável. A segurança também é importante, o que significa que temos modelos para aplicações internas, externas ou ambas.

JNF developed different kinds of standoffs for the multiple requests. The aesthetics is one point where the shape can be rounded or square, but also the finish can be satin or pvd titanium with colors from black, gold, copper or chocolate. Technically, different types and thicknesses of glass were included, as well as different distances from the wall, in some models adjustable. Safety is also important, which means we have models for indoor, outdoor applications or both.

JNF ha desarrollado diferentes tipos de soportes de cristal para las múltiples solicitudes. La estética es un punto, en puede ser redonda o cuadrada, pero también el acabado puede ser de satinado o titanio pvd con colores negro, dorado, cobre o chocolate. Técnicamente se contemplaron diferentes tipos y espesores de cristal y también diferentes distancias a la pared, en algunos modelos ajustables. La seguridad también es importante, por lo que tenemos modelos para aplicaciones en interiores, exteriores o ambas.

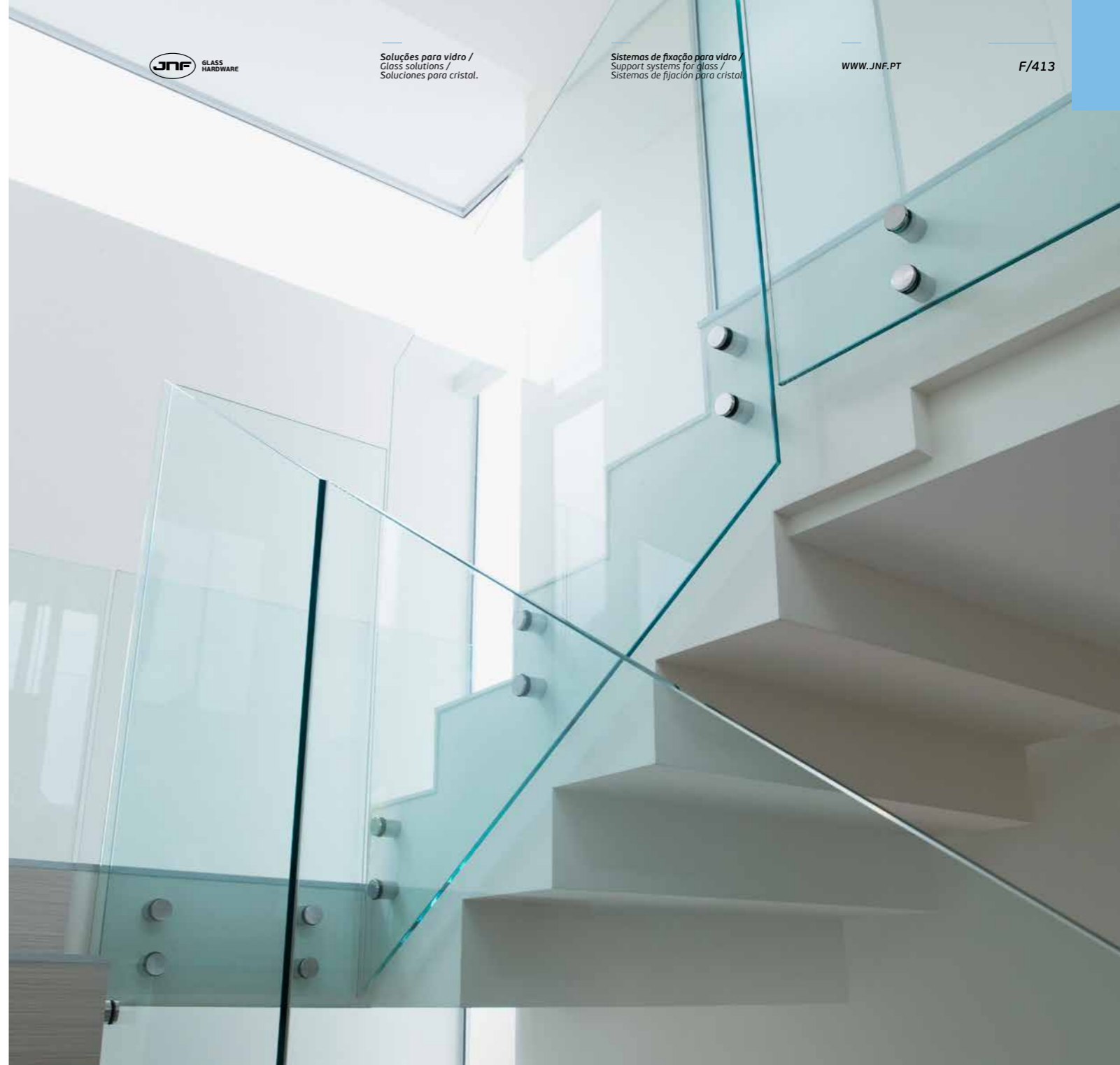

SISTEMAS DE FIXAÇÃO PARA VIDRO / SUPPORT SYSTEMS FOR GLASS / SISTEMAS DE FIJACIÓN PARA CRISTAL.

IN.80.802
Suporte para vidro.Fixação à parede / Glass support. Wall fixing / Soporte para cristal. Sujeción a pared



MATERIAL: EN 1.4301 / AISI 304

ACABAMENTO / FINISH / ACABADO: STANDARD: SATINADO / SATIN / SATIN

OPTIONAL: PVD TITANIUM COATED

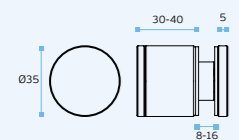

IN.80.802.P
Suporte para vidro.Fixação à parede / Glass support. Wall fixing / Soporte para cristal. Sujeción a pared



MATERIAL: EN 1.4301 / AISI 304

ACABAMENTO / FINISH / ACABADO: STANDARD: POLIDO / POLISHED / PULIDO

OPTIONAL: PVD TITANIUM COATED

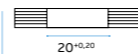
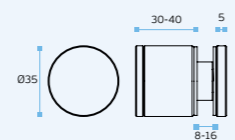

IN.80.802.50
Suporte para vidro.Fixação à parede / Glass support. Wall fixing / Soporte para cristal. Sujeción a pared



MATERIAL: EN 1.4301 / AISI 304

ACABAMENTO / FINISH / ACABADO: STANDARD: SATINADO / SATIN / SATIN

OPTIONAL: PVD TITANIUM COATED

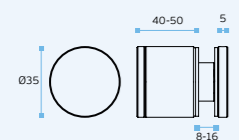

IN.80.802.50.P
Suporte para vidro.Fixação à parede / Glass support. Wall fixing / Soporte para cristal. Sujeción a pared



MATERIAL: EN 1.4301 / AISI 304

ACABAMENTO / FINISH / ACABADO: STANDARD: POLIDO / POLISHED / PULIDO

OPTIONAL: PVD TITANIUM COATED

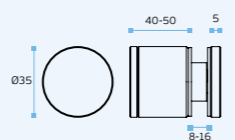

GLASS 3D STANDOFF



Série 3D STAND OFF foi desenvolvida para fazer ajustes fáceis nos 3 eixos. A profundidade pode ir do afastamento de 30 a 50mm relativamente à parede. Um modelo ajusta de 30 a 40mm e outro de 41 a 50mm, garantindo o alinhamento perfeito entre vidros.

O posicionado do parafuso de fixação tem uma forma especial para permitir o movimento das ferragens nos eixos X e Y. Todos os ajustes são possíveis com o vidro já instalado.

Acabamentos em PVD TITANIUM, satinado ou polido estão disponíveis nesta gama.

3D STAND OFF series was developed to make easy adjustments in the 3 axes. The depth can range from 30 to 50mm away from the wall. One model adjusts from 30 to 40mm and the other from 41 to 50mm, ensuring perfect alignment between glass.

The fixing screw hole has a special shape that allows movement of the fittings in the X and Y axle. All those adjustments are possible with the glass already in place.

PVD TITANIUM finishes, satin or mirror finishes are available in this range.

Serie 3D STAND OFF fue desarrollada para hacer ajustes fáciles en los 3 ejes. La profundidad puede pasar de 30 a 50mm. Un modelo se ajusta de 30 a 40mm y otro de 41 a 50mm, garantizando una alineación perfecta del cristal.

El orificio del tornillo de fijación tiene una forma especial para permitir el movimiento de los accesorios en los ejes X e Y. Todo este ajuste es posible con el cristal ya en su lugar.

En esta gama están disponibles acabados PVD TITANIUM, satinado o pulidos.

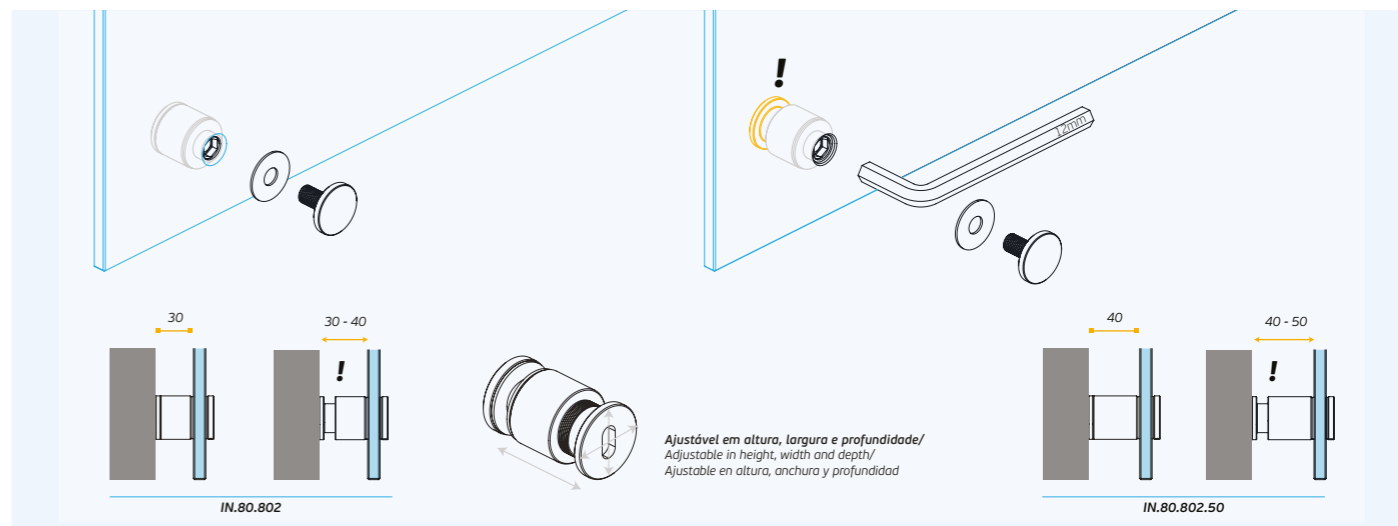
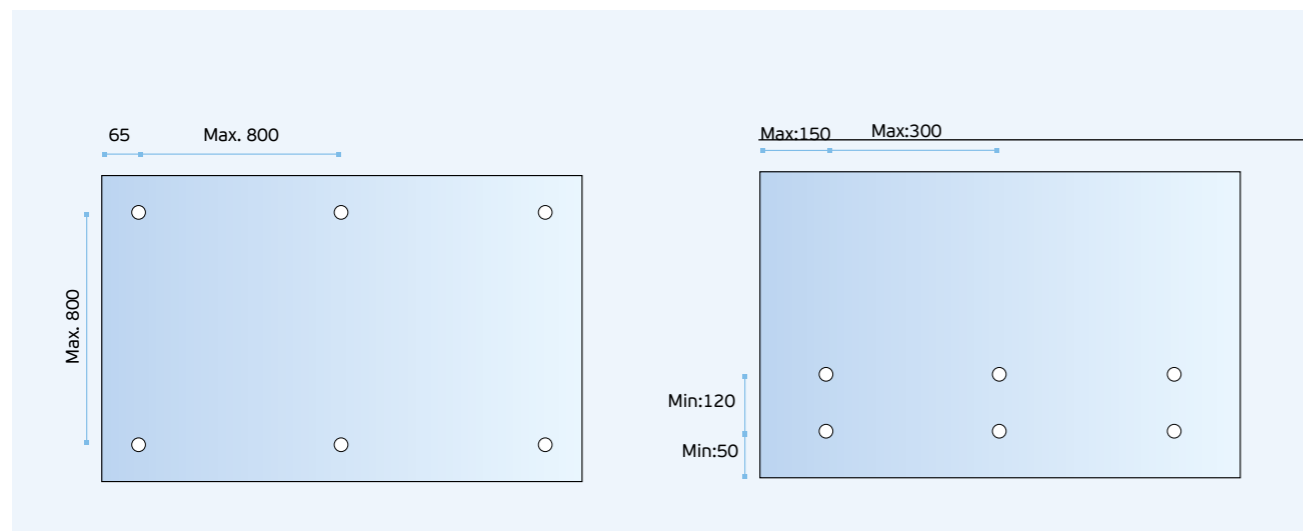

SISTEMAS DE FIXAÇÃO PARA VIDRO / SUPPORT SYSTEMS FOR GLASS / SISTEMAS DE FIJACIÓN PARA CRISTAL.

IN.80.106.

Suporte para vidro. Fixação à parede / Glass support wall fixing / Soporte para cristal Sujeción a pared.

.TB .TG .TCO .TCH

8-14 mm GC107 glass cut 45 kg INT

MATERIAL: EN 1.4301 / AISI 304

ACABAMENTO / FINISH / ACABADO: STANDARD: SATINADO / SATIN / SATIN

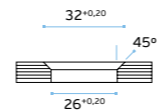
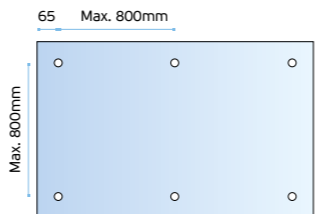
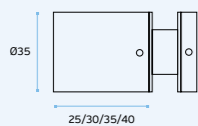

IN.80.109

Suporte para vidro. Fixação à parede / Glass support wall fixing / Soporte para cristal Sujeción a pared.

10-12 mm GC109 glass cut 30 kg INT

MATERIAL: EN 1.4301 / AISI 304

ACABAMENTO / FINISH / ACABADO: STANDARD: SATINADO / SATIN / SATIN

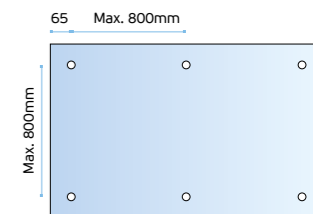
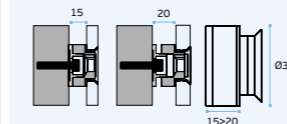

IN.80.106.25
IN.80.107.25
25mm



IN.80.106.30
IN.80.107.30
30mm



IN.80.106.35
IN.80.107.35
35mm



IN.80.106.40
IN.80.107.40
40mm

IN.80.108

Suporte para vidro. Fixação à parede / Glass support wall fixing / Soporte para cristal Sujeción a pared.

8-12 mm 30 kg INT

MATERIAL: EN 1.4301 / AISI 304

ACABAMENTO / FINISH / ACABADO: STANDARD: SATINADO / SATIN / SATIN

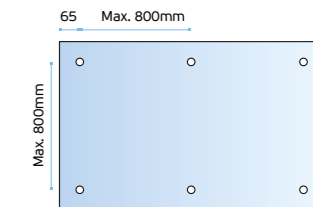
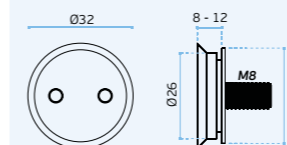

IN.80.107.

Suporte para vidro. Fixação à parede / Glass support wall fixing / Soporte para cristal Sujeción a pared.

.TB .TG .TCO .TCH

8-14 mm GC107 glass cut 45 kg INT

MATERIAL: EN 1.4301 / AISI 304

ACABAMENTO / FINISH / ACABADO: STANDARD: SATINADO / SATIN / SATIN

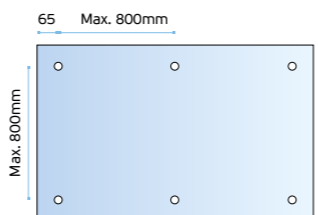
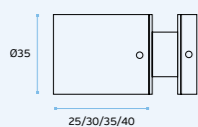

IN.80.250

Suporte para vidro. Fixação à parede / Glass support wall fixing / Soporte para cristal Sujeción a pared.

5-12 mm 10 kg INT



MATERIAL: EN 1.4301 / AISI 304

ACABAMENTO / FINISH / ACABADO: STANDARD: SATINADO / SATIN / SATIN

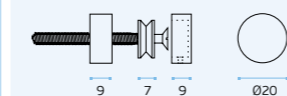

SISTEMAS DE FIXAÇÃO PARA VIDRO / SUPPORT SYSTEMS FOR GLASS / SISTEMAS DE FIJACIÓN PARA CRISTAL.

NEW

IN.80.853.17

Suporte de pavimento para vidro monolítico temperado e/ou vidro temperado laminado. Espessura para vidro máx. 17mm / Floor support for monolithic tempered glass and/or laminated tempered glass. Thickness for glass 17mm maximum / Soporte de pavimento para cristal templado monolítico y/o cristal laminado templado. El espesor del cristal es 17mm máximo.

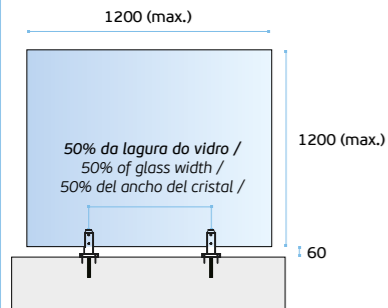

MATERIAL: EN 1.4401 / AISI 316

ACABAMENTO / FINISH / ACABADO:
STANDARD: SATINADO / SATIN / SATIN

OPCIONAL / OPTIONAL: PVD TITANIUM

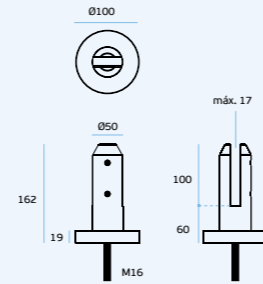

2IN1

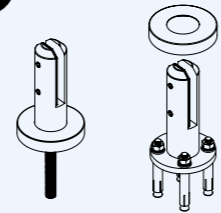

Dois tipos de fixação ao pavimento (com o mesmo suporte) / Two types of fixing to the floor (with the same support) / Dos tipos de fijación al suelo (con el mismo soporte).

Para vidro monolítico temperado e laminado temperado / For tempered monolithic & tempered laminated glass / Para cristal templado monolítico y templado laminado.

GLASS POOL FENCE

O vidro sem moldura continua a ser uma solução popular, segura e económica para vedação de piscinas. Os postes são uma parte importante deste sistema, garantem a estabilidade de todos os painéis de vidro.

Estes postes podem ser usadas em diferentes situações (não apenas como vedações de piscinas), são solução para manter um vidro estável verticalmente quando o podemos fixar ao chão, por exemplo em varandas.

Conjuntamente com os postes, desenvolvemos outros acessórios para tornar essas estruturas mais estáveis.

Frameless glass remains a popular, safe and cost effective solution for pool fencing. The poles are an important part of this system, guarantee the stability of all glass panels.

These poles can be used in different situations (not only as pool fencing), they are a solution for keeping a glass steady vertically when we can fix the base to the floor, for example balconies.

Together with the poles, we developed other accessories to make these structures more stable.

El cristal sin marco sigue siendo una solución popular, segura y económica para el sellado de piscinas. Los postes son una parte importante de este sistema, garantizan la estabilidad de todos los paneles de cristal.

Estos postes se pueden utilizar en diferentes situaciones (no solo como vedaciones de piscinas), son una solución para mantener un cristal estable verticalmente cuando podemos fijarlo al suelo, por ejemplo en balcones.

Junto con los postes, hemos desarrollado otros accesorios para que estas estructuras sean más estables.

IN.80.853

Suporte de pavimento para vidro monolítico temperado e/ou vidro temperado laminado. Espessura para vidro máx. 12,7mm / Floor support for monolithic tempered glass and/or laminated tempered glass. Thickness for glass 12,7mm maximum / Soporte de pavimento para cristal templado monolítico y/o cristal laminado templado. El espesor del cristal es 12,7mm máximo.

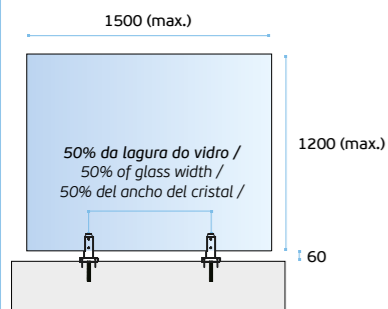

MATERIAL: EN 1.4401 / AISI 316

ACABAMENTO / FINISH / ACABADO:
STANDARD: SATINADO / SATIN / SATIN

OPCIONAL / OPTIONAL: PVD TITANIUM

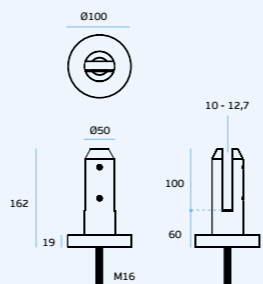

2IN1

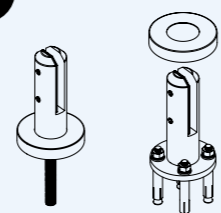

Dois tipos de fixação ao pavimento (com o mesmo suporte) / Two types of fixing to the floor (with the same support) / Dos tipos de fijación al suelo (con el mismo soporte).

Para vidro monolítico temperado e laminado temperado / For tempered monolithic & tempered laminated glass / Para cristal templado monolítico y templado laminado.



SISTEMAS DE FIXAÇÃO PARA VIDRO / SUPPORT SYSTEMS FOR GLASS / SISTEMAS DE FIJACIÓN PARA CRISTAL.

NEW

IN.80.854

Suporte de pavimento para vidro monolítico temperado e/ou vidro temperado laminado. Espessura para vidro máx. 15mm / Floor support for monolithic tempered glass and/or laminated tempered glass. Thickness for glass 15mm maximum / Soporte de pavimento para cristal templado monolítico y/o cristal laminado templado. El espesor del cristal es 15mm máximo.

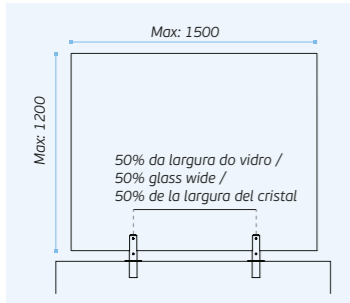
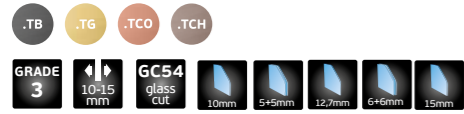

MATERIAL: EN 1.4401 / AISI 316
ACABAMENTO / FINISH / ACABADO: STANDARD: SATINADO / SATIN / SATIN
OPCIONAL / OPTIONAL: PVD TITANIUM

Para vidro monolítico temperado e laminado temperado / For tempered monolithic & tempered laminated glass / Para cristal templado monolítico y templado laminado.

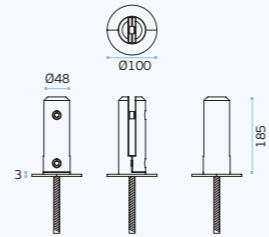

IN.80.852.S

Suporte de pavimento para vidro / Floor glass support / Soporte de pavimento para cristal. Satinado/ Satin / Satin

IN.80.852

Suporte de pavimento para vidro / Floor glass support / Soporte de pavimento para cristal. Polido/ Polished / Pulido

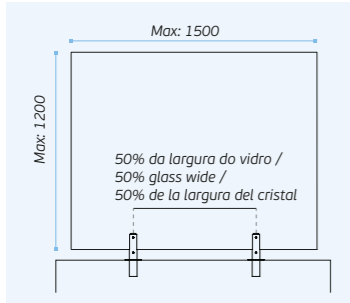
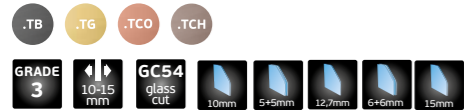

MATERIAL: EN 1.4401 / AISI 316
ACABAMENTO / FINISH / ACABADO: STANDARD: SATINADO + POLIDO / SATIN + POLISHED / SATIN + PULIDO

Para vidro monolítico temperado e laminado temperado / For tempered monolithic & tempered laminated glass / Para cristal templado monolítico y templado laminado.

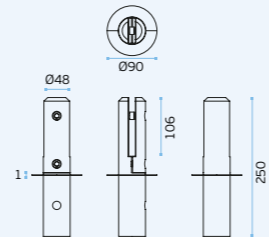

IN.80.860

Estabilizador para vidros com ângulo ajustável / Stabilizer for glasses with adjustable angle / Estabilizador para cristal con ángulo ajustable.

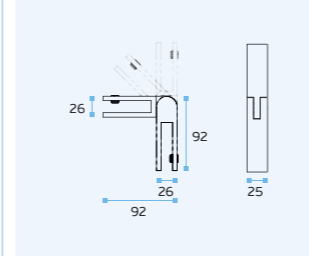

MATERIAL: EN 1.4301 / AISI 304
ACABAMENTO / FINISH / ACABADO: STANDARD: SATINADO / SATIN / SATIN

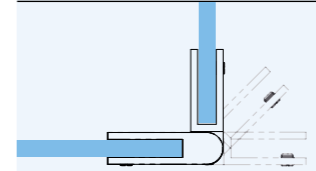

IN.80.861

Estabilizador para vidros 90° / 90° stabilizer for glass / Estabilizador para cristal 90°

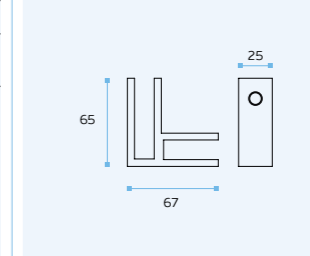

MATERIAL: EN 1.4301 / AISI 304
ACABAMENTO / FINISH / ACABADO: STANDARD: SATINADO / SATIN / SATIN

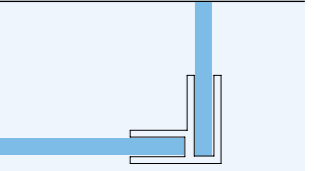

IN.80.862

Estabilizador para vidros 180° / 180° stabilizer for glass / Estabilizador para cristal 180°

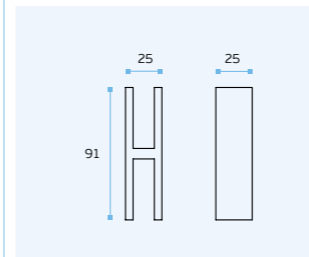

MATERIAL: EN 1.4301 / AISI 304
ACABAMENTO / FINISH / ACABADO: STANDARD: SATINADO / SATIN / SATIN

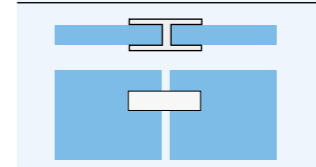

IN.80.861.17

Estabilizador para vidros 90° / 90° stabilizer for glass / Estabilizador para cristal 90°

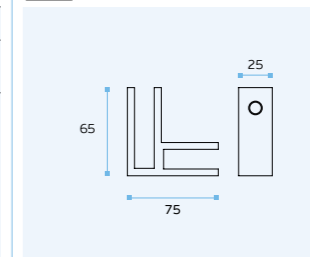

MATERIAL: EN 1.4301 / AISI 304
ACABAMENTO / FINISH / ACABADO: STANDARD: SATINADO / SATIN / SATIN

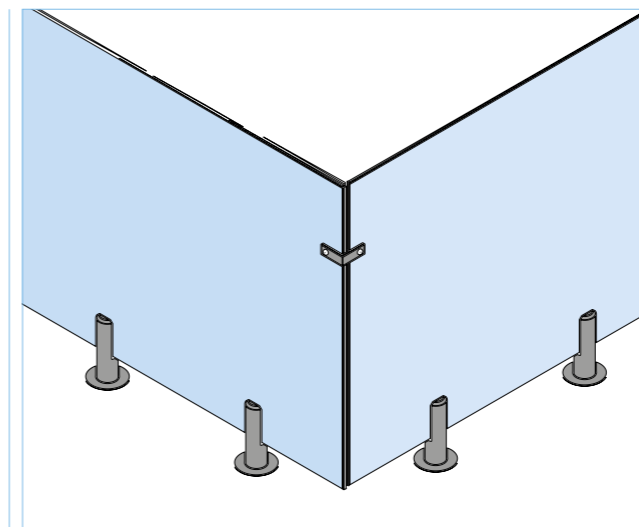
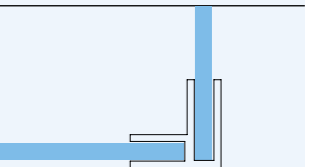

IN.80.870

Estabilizador para vidros 180° / 180° stabilizer for glass / Estabilizador para cristal 180°

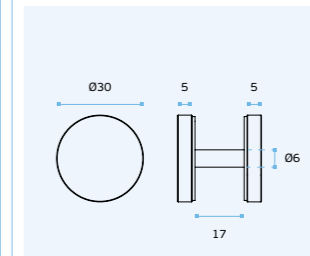

MATERIAL: EN 1.4301 / AISI 304
ACABAMENTO / FINISH / ACABADO: STANDARD: SATINADO / SATIN / SATIN

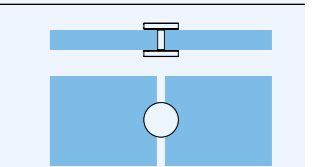

SISTEMAS DE FIXAÇÃO PARA VIDRO / SUPPORT SYSTEMS FOR GLASS / SISTEMAS DE FIJACIÓN PARA CRISTAL.

IN.05.322

Conjunto de duas dobradiças hidráulicas, parede - vidro /
Set of two hydraulic glass to wall hinges /
Juego de dos bisagras hidráulicas pared - cristal.

.TB .TG .TCO .TCH

MATERIAL: EN 1.4301 / AISI 304

ACABAMENTO / FINISH / ACABADO:
STANDARD: SATINADO / SATIN / SATIN

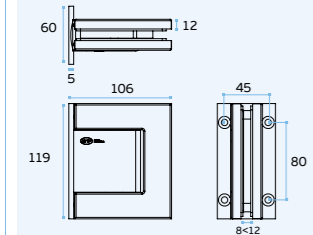

HYDRAULIC SYSTEM

- Velocidade de fecho regulável por válvula
- Largura da porta: 1000mm (máx.)
- Peso: 100kg (máx.)
- Espessura do vidro: 8-12,7mm
- Patente internacional

- Closing speed adjustable by valve
- Door width: 1000mm (max.)
- Weight: up to 100kg (max.)
- Glass thickness: 8-12,7mm
- International patent

- Velocidad de cierre regulable por válvula
- Ancho de la puerta: 1000 mm (máx.)
- Peso: 100 kg (máx.)
- Espesor del cristal: 8-12,7 mm
- Patente internacional

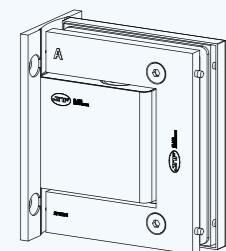

A - Dobradiça com mola /
Spring hinge /
Bisagra con muelle

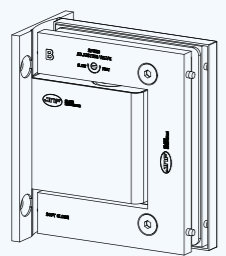
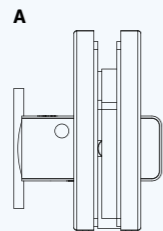

B - Dobradiça com amortecedor /
Soft close hinge /
Bisagra con amortiguador



Ajuste da velocidade de fecho /
Closing speed adjustment /
Ajuste de la velocidad de cierre.

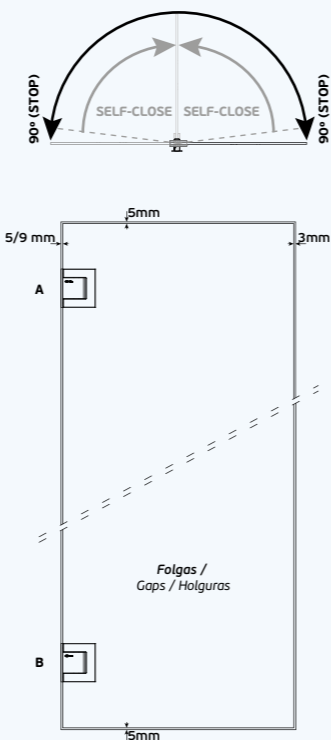
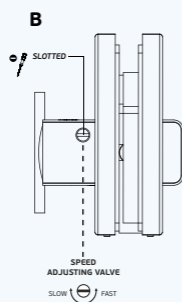

Folgas /
Gaps / Holguras

IN.20.341.QP.12

Fechadura magnética de passagem para portas de vidro com puxador de um lado. Não permite acesso a crianças pequenas, caso instalada em portas com mínimo de 1200mm de altura /
Magnetic door lock passage type for glass with door handle from one side. Don't allow the access to small children if installed in doors with minimum height of 1200mm /
Cerradura magnética de paospara portas de cristal con manilla de un lado. No permitir acceso a niños pequeños se instalada en puertas con ancho minimo de 1200mm.



MATERIAL: EN 1.4301 / AISI 304 + ALUMINIUM

ACABAMENTO / FINISH / ACABADO:
STANDARD: SATINADO / SATIN

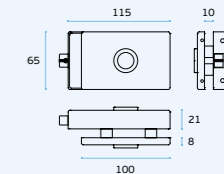

IN.20.339.A

Testa reversível para aplicar no aro da porta / Reversible strike plate to apply in the door frame /
Cerradero reversible para aplicar no marco de la puerta.



MATERIAL: EN 1.4301 / AISI 304

ACABAMENTO / FINISH / ACABADO:
STANDARD: SATINADO / SATIN / SATIN

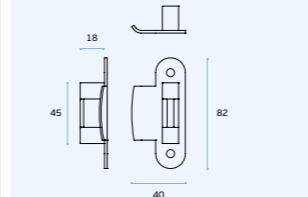

IN.20.339.B

Testa reversível para aplicar no aro da porta / Reversible strike plate to apply in the door frame /
Cerradero reversible para aplicar no marco de la puerta.



MATERIAL: EN 1.4301 / AISI 304

ACABAMENTO / FINISH / ACABADO:
STANDARD: SATINADO / SATIN / SATIN

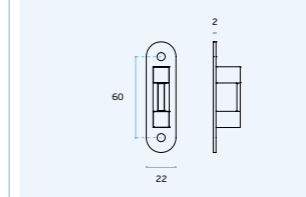

IN.20.338.Q

Caixa / testa de fechadura para portas de vidro (reversível) / Strike box for door lock for glass (reversible) /
Caja / cerradera de cerradura (reversible).



MATERIAL: EN 1.4301 / AISI 304

ACABAMENTO / FINISH / ACABADO:
STANDARD: SATINADO / SATIN / SATIN

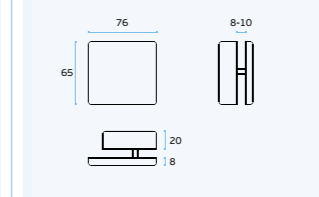

PINÇAS PARA VIDRO / GLASS CLAMPS / PINZAS PARA CRISTAL.

Ensaio dinâmico, de acordo com as normas NP 4491:2009 – PT (Pontos 5.2 e 5.3) e EN12600 (Ponto 5.1), de forma a garantir a resistência adequada.

Massa de corpo mole: 50kg ± 0.5kg.

Grau 1:
 - Utilização em interiores, proteção mínima ao impacto
 - Peso largado a H:190mm
 - Energia de choque 95J

Grau 2:
 - Utilização em interiores, proteção média ao impacto
 - Peso largado a H:450mm
 - Energia de choque 225J

Grau 3:
 - Utilização em interiores e exteriores, proteção alta ao impacto
 - Peso largado a H:1200mm
 - Energia de choque 600J

Dynamic tests according to standards EN12600 (section 5.1) and NP 4491:2009 – PT (section 5.2 e 5.3), to ensure the adequate strength.

Mass of dead body: 50kg ± 0.5kg.

Grade 1:
 - Indoor use, minimal protection to impact
 - Dropped weight at H:190mm
 - Shock energy 95J

Grade 2:
 - Indoor use, medium protection to impact
 - Dropped weight at H:450mm
 - Shock energy 225J

Grade 3:
 - Indoor and outdoor use, high protection to impact
 - Dropped weight at H:1200mm
 - Shock energy 600J

Pruebas dinámicas, de acuerdo con las normas EN12600 (Punto 5.1) y NP 4491:2009 – PT (Puntos 5.2 e 5.3), para garantizar la resistencia adecuada.

Masa de cuerpo blando: 50 kg ± 0.5kg.

Grado 1:
 - Uso interior, protección mínima al impacto
 - Peso caído a H:190mm
 - Energía de choque 95J

Grado 2:
 - Uso interior, protección media al impacto
 - Peso caído a H:450mm
 - Energía de choque 225J

Grado 3:
 - Uso interior y exterior, protección alta al impacto
 - Peso caído a H:1200mm
 - Energía de choque 600J

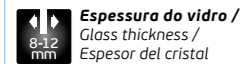
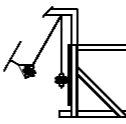
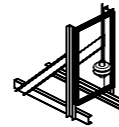
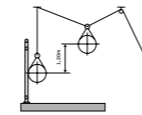

Espessura do vidro /
 Glass thickness /
 Espesor del cristal



Superfície plana para fixação /
 Flat surface fix /
 Superficie plana de fijacion

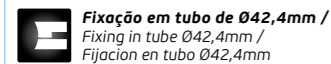

Fixação em tubo de Ø42,4mm /
 Fixing in tube Ø42,4mm /
 Fijacion en tubo Ø42,4mm

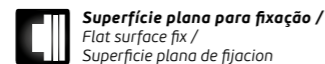

Superfície plana para fixação /
 Flat surface fix /
 Superficie plana de fijacion

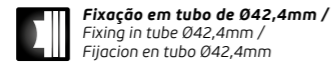

Fixação em tubo de Ø42,4mm /
 Fixing in tube Ø42,4mm /
 Fijacion en tubo Ø42,4mm

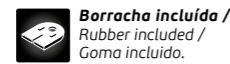

Borracha incluída /
 Rubber included /
 Goma incluido.

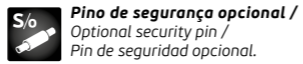

Pino de segurança opcional /
 Optional security pin /
 Pin de seguridad opcional.

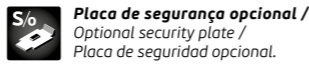

Placa de segurança opcional /
 Optional security plate /
 Placa de seguridad opcional.

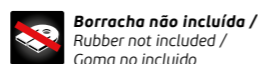

Borracha não incluída /
 Rubber not included /
 Goma no incluido

STANDARD

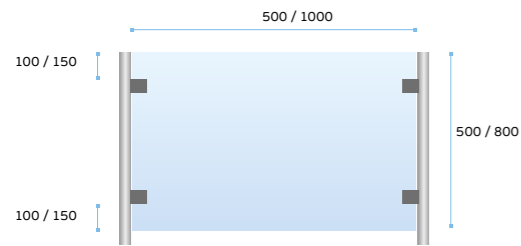

Pinças para vidro sem pino e sem placa de segurança / Glass clamp without safety pin and plate / Soporte de cristal sin pino y placa de seguridad.

SECURITY PLATE



Pinças para vidro com placa de segurança e sem pino de segurança. Recomendado para uso exterior / Glass clamp with security plate and without safety pin. Recommended for outside use / Soporte de cristal con placa de seguridad y sin pino de seguridad. Recomendado para utilización exterior.

SECURITY PIN



Pinças para vidro com pino e sem placa de segurança. Recomendado para uso exterior / Glass clamp with safety pin and without security plate. Recommended for outside use / Soporte de cristal con pino y sin placa de seguridad. Recomendado para utilización exterior.



Tubo / Tube: Ø42,4 mm

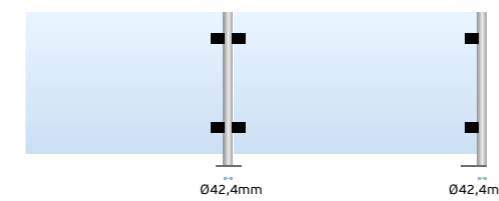

IN.80.203
 IN.80.211
 IN.80.213
 IN.80.218

IN.80.103
 IN.80.111
 IN.80.113

Superfície plana / Flat surface / Superficie plana

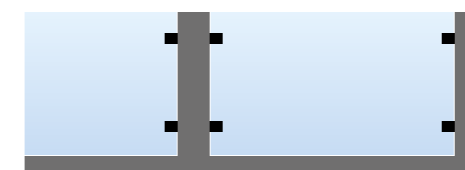

IN.80.204
 IN.80.212
 IN.80.214
 IN.80.219

IN.80.102
 IN.80.104
 IN.80.112
 IN.80.114

Fixação frontal / Front fixture / Montaje frontal

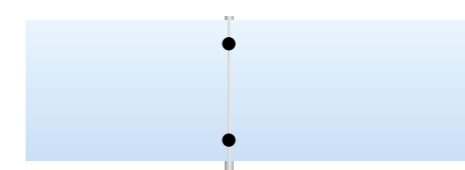

IN.80.096
 IN.80.098

IN.80.097
 IN.80.099

PINÇAS PARA VIDRO / GLASS CLAMPS / PINZAS PARA CRISTAL.

GRADE 3



IN.80.211
Suporte para vidro para tubo 42,4mm / Glass clamp for tube 42,4mm / Soporte para cristal para tubo 42,4mm.

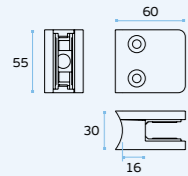

MATERIAL:
IN.80.211: EN 1.4301 / AISI 304
ACABAMENTO / FINISH / ACABADO:
STANDARD: SATINADO / SATIN / SATIN



IN.80.212
Suporte para vidro. Fixação à parede (borrachas e pino de segurança incluído) / Glass support. Wall fixing (rubbers and security pin included) / Soporte para cristal. Sujeción a pared. (gomos y passador de seguridad incluidos)

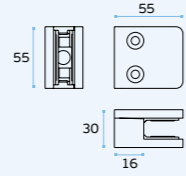

MATERIAL:
IN.80.212: EN 1.4301 / AISI 304
ACABAMENTO / FINISH / ACABADO:
STANDARD: SATINADO / SATIN / SATIN

Para vidro monolítico temperado e laminado temperado / For tempered monolithic & tempered laminated glass / Para cristal templado monolítico y templado laminado.

Borrachas vendidas em separado / Rubber separately sold / Venta de goma por separado.



Para vidro monolítico temperado e laminado temperado / For tempered monolithic & tempered laminated glass / Para cristal templado monolítico y templado laminado.

IN.80.218
Suporte para vidro para tubo 42,4mm. (borrachas e pino de segurança incluído) / Glass clamp for tube 42,4mm. (rubbers and security pin included) / Soporte para cristal para tubo 42,4mm. (gomos y passador de seguridad incluidos)

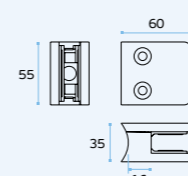

MATERIAL: EN 1.4301 / AISI 304
ACABAMENTO / FINISH / ACABADO:
STANDARD: SATINADO / SATIN / SATIN

Borrachas vendidas em separado / Rubber separately sold / Venta de goma por separado.



IN.80.219
Suporte para vidro com fixação à parede. (borrachas e pino de segurança incluído) / Glass support with wall fixing. (rubbers and security pin included) / Soporte para cristal con sujeción a pared. (gomos y passador de seguridad incluidos)

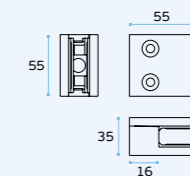

MATERIAL: EN 1.4301 / AISI 304
ACABAMENTO / FINISH / ACABADO:
STANDARD: SATINADO / SATIN / SATIN



IN.80.213
Suporte para vidro para tubo 42,4mm / Glass clamp for tube 42,4mm / Soporte para cristal para tubo 42,4mm.

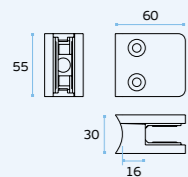

MATERIAL:
IN.80.213: EN 1.4401 / AISI 316
ACABAMENTO / FINISH / ACABADO:
STANDARD: SATINADO / SATIN / SATIN



IN.80.214
Suporte para vidro. Fixação à parede (borrachas e pino de segurança incluído) / Glass support. Wall fixing (rubbers and security pin included) / Soporte para cristal. Sujeción a pared. (gomos y passador de seguridad incluidos)

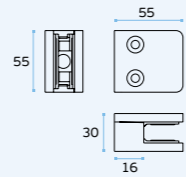

MATERIAL:
IN.80.214 EN 1.4401 / AISI 316
ACABAMENTO / FINISH / ACABADO:
STANDARD: SATINADO / SATIN / SATIN

Para vidro monolítico temperado e laminado temperado / For tempered monolithic & tempered laminated glass / Para cristal templado monolítico y templado laminado.

Borrachas vendidas em separado / Rubber separately sold / Venta de goma por separado.

Para vidro monolítico temperado e laminado temperado / For tempered monolithic & tempered laminated glass / Para cristal templado monolítico y templado laminado.

Borrachas vendidas em separado / Rubber separately sold / Venta de goma por separado.



IN.80.215
Borrachas para suportes / Rubber inlays / Gomas para pinzas.

REF	VIDRO / GLASS / CRISTAL
IN.80.215	8 mm
IN.80.216	10 mm
IN.80.217	12,7 mm



IN.80.117
Pino de segurança / Security pin / Pasadores de seguridad.



MATERIAL: EN 1.4301 / AISI 304
ACABAMENTO / FINISH / ACABADO:
STANDARD: SATINADO / SATIN / SATIN

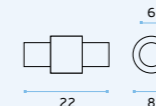

IN.80.120
x2 tampas para parafusos laterais / x2 cover caps for lateral screws / x2 tapones para tornillos laterales.

MATERIAL: NYLON

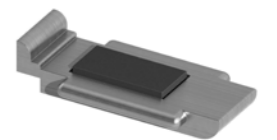
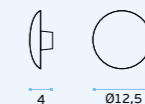

IN.80.121
Placa de segurança / Security plate / Seguridad placa.



MATERIAL: EN 1.4301 / AISI 304
ACABAMENTO / FINISH / ACABADO:
STANDARD: SATINADO / SATIN / SATIN

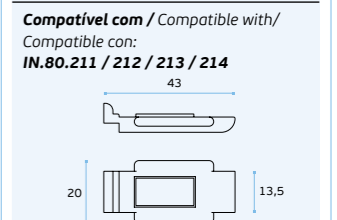

PINÇAS PARA VIDRO / GLASS CLAMPS / PINZAS PARA CRISTAL.



IN.80.111
IN.80.113
Suporte para vidro para tubo 42,4mm / Glass clamp for tube 42,4mm / Soporte para cristal para tubo 42,4mm.

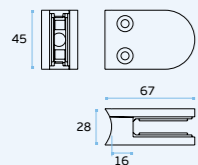

MATERIAL:
IN.80.111: EN 1.4301 / AISI 304
IN.80.113: EN 1.4401 / AISI 316
ACABAMENTO / FINISH / ACABADO:
STANDARD: SATINADO / SATIN / SATIN



IN.80.112
IN.80.114
Suporte para vidro. Fixação à parede / Glass support wall fixing / Soporte para cristal. Sujeción a pared.

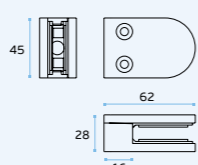

MATERIAL:
IN.80.112: EN 1.4301 / AISI 304
IN.80.114: EN 1.4401 / AISI 316
ACABAMENTO / FINISH / ACABADO:
STANDARD: SATINADO / SATIN / SATIN

Para vidro monolítico temperado e laminado temperado / For tempered monolithic & tempered laminated glass / Para cristal templado monolítico y templado laminado.

Para vidro monolítico temperado e laminado temperado / For tempered monolithic & tempered laminated glass / Para cristal templado monolítico y templado laminado.



IN.80.099
Suporte para vidro. Fixação à parede / Glass support wall fixing / Soporte para cristal. Sujeción a pared.

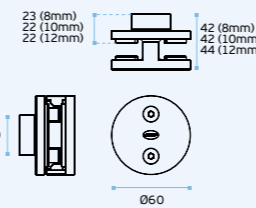

MATERIAL: EN 1.4401 / AISI 316
ACABAMENTO / FINISH / ACABADO:
STANDARD: SATINADO / SATIN / SATIN



IN.80.096
Suporte para vidro para tubo 42,4mm / Glass clamp for tube 42,4mm / Soporte para cristal para tubo 42,4mm.

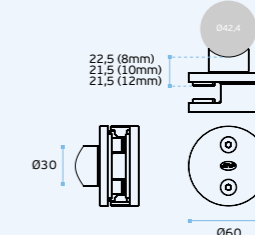

MATERIAL: EN 1.4401 / AISI 316
ACABAMENTO / FINISH / ACABADO:
STANDARD: SATINADO / SATIN / SATIN



IN.80.102
Suporte para vidro. Fixação à parede / Glass support wall fixing / Soporte para cristal. Sujeción a pared.

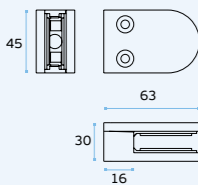

MATERIAL: EN 1.4401 / AISI 316
ACABAMENTO / FINISH / ACABADO:
STANDARD: SATINADO / SATIN / SATIN



IN.80.115
Borrachas para suportes / Rubber inlays / Gomas para pinzas.

REF	VIDRO / GLASS / CRISTAL
IN.80.115	8 mm
IN.80.116	10 mm

Borrachas vendidas em separado / Rubber separately sold / Venta de goma por separado.

Para vidro monolítico temperado e laminado temperado / For tempered monolithic & tempered laminated glass / Para cristal templado monolítico y templado laminado.



IN.80.098
Suporte para vidro. Fixação à parede / Glass support wall fixing / Soporte para cristal. Sujeción a pared.

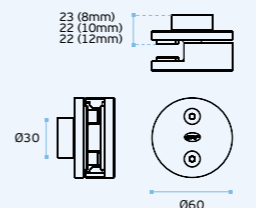

MATERIAL: EN 1.4401 / AISI 316
ACABAMENTO / FINISH / ACABADO:
STANDARD: SATINADO / SATIN / SATIN



IN.80.097
Suporte para vidro para tubo 42,4mm / Glass clamp for tube 42,4mm / Soporte para cristal para tubo 42,4mm.

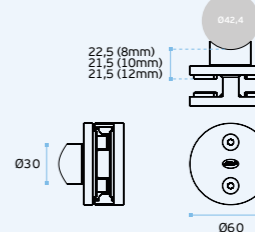

MATERIAL: EN 1.4401 / AISI 316
ACABAMENTO / FINISH / ACABADO:
STANDARD: SATINADO / SATIN / SATIN

BARREIRAS DE CONFINAMENTO

CONTAINMENT BARRIER / BARRERA DE CONTENCIÓN



NEW



IN.80.026.C
Suporte para painel de proteção centrado /
Centered screen protection support /
Herraje para pantallas centrado.

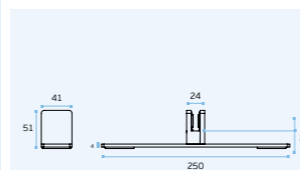

MATERIAL: EN 1.4301 / AISI 304

ACABAMENTO / FINISH / ACABADO
STANDARD: SATINADO / SATIN

NEW



IN.80.026
Suporte para painel de proteção descentrado /
Screen protection support /
Herraje para pantallas

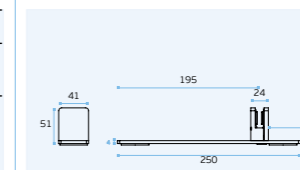

MATERIAL: EN 1.4301 / AISI 304

ACABAMENTO / FINISH / ACABADO
STANDARD: SATINADO / SATIN

NEW

IN.80.027
Suporte em aço inoxidável para painel de
proteção para vidro ou acrílico. Ajustável
(10-55mm) /
Screen protection support in stainless steel for
glass or acrylic. Adjustable (10-55mm) /
Soporte en acero inoxidable para panel de
protección para cristal o acrílico. Ajustable
(10-55mm).

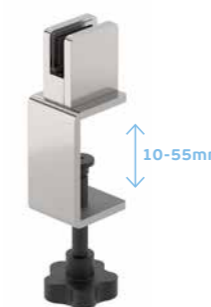

MATERIAL: EN 1.4301 / AISI 304

ACABAMENTO / FINISH / ACABADO
STANDARD: SATINADO / SATIN

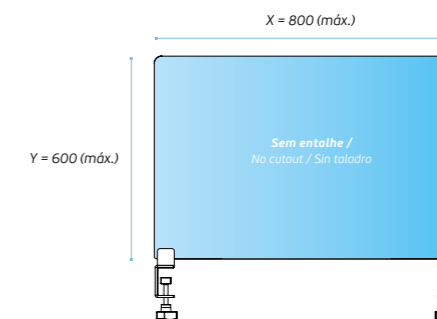
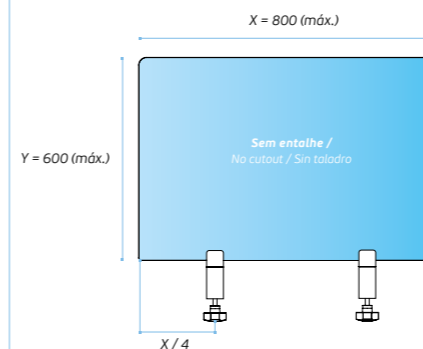
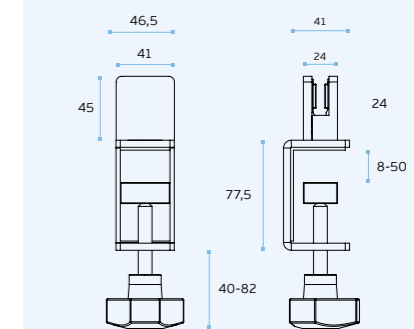

BARREIRAS DE CONFINAMENTO

CONTAINMENT BARRIER / BARRERA DE CONTENCIÓN

NEW



IN.80.020.70
Suporte para painel de proteção para vidro ou acrílico (70mm) /
Screen protection support for glass or acrylic (70mm) /
Herraje para pantallas de protección para cristal o acrílico (70mm)

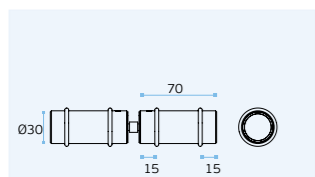

MATERIAL: EN 1.4301 / AISI 304
ACABAMENTO / FINISH / ACABADO
STANDARD: SATINADO / SATIN

NEW



IN.80.020.140
Suporte para painel de proteção para vidro ou acrílico (140mm) /
Screen protection support for glass or acrylic (140mm) /
Herraje para pantallas de protección para cristal o acrílico (140mm)

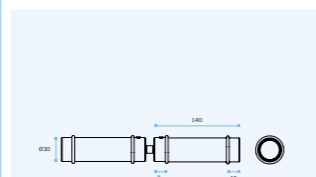

MATERIAL: EN 1.4301 / AISI 304
ACABAMENTO / FINISH / ACABADO
STANDARD: SATINADO / SATIN

NEW



IN.80.024
Suporte para painel de proteção centrado para vidro ou acrílico /
Centered screen protection support for glass or acrylic /
Soporte para panel de protección centrado para cristal o acrílico.

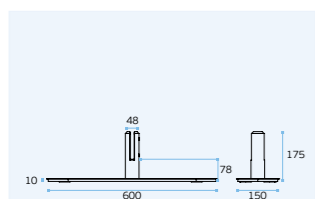

MATERIAL: EN 1.4301 / AISI 304
ACABAMENTO / FINISH / ACABADO
STANDARD: SATINADO / SATIN

NEW



IN.80.024.D
Suporte para painel de proteção descentrado para vidro ou acrílico /
Centered screen protection support for glass or acrylic /
Soporte para panel de protección descentrado para cristal o acrílico.

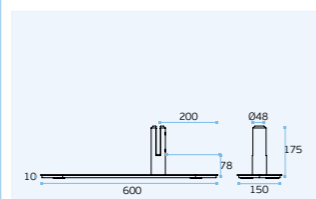

MATERIAL: EN 1.4301 / AISI 304
ACABAMENTO / FINISH / ACABADO
STANDARD: SATINADO / SATIN



BARREIRAS DE CONFINAMENTO

CONTAINMENT BARRIER / BARRERA DE CONTENCIÓN



NEW

IN.80.029

Suporte em aço inoxidável para painel de proteção para vidro ou acrílico. Para painéis com a espessura máxima de 10mm /
Screen protection support in stainless steel for glass or acrylic. For panels with a maximum thickness of 10mm
Soporte en acero inoxidable para panel de protección para cristal o acrílico para paneles con un espesor máximo de 10mm.

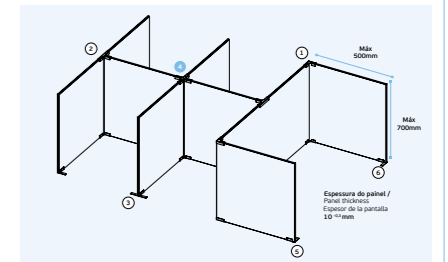
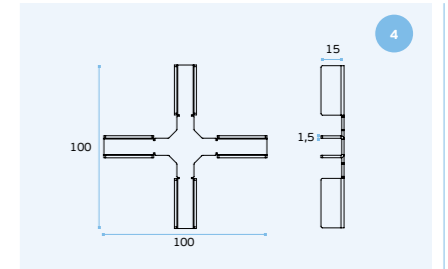
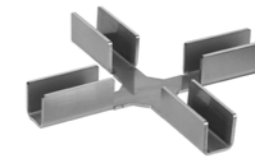
**MATERIAL:** EN 1.4301 / AISI 304**ACABAMENTO / FINISH / ACABADO**
STANDARD: SATINADO / SATIN

NEW

IN.80.030

Suporte em aço inoxidável para painel de proteção para vidro ou acrílico. Para painéis com a espessura máxima de 10mm /
Screen protection support in stainless steel for glass or acrylic. For panels with a maximum thickness of 10mm
Soporte en acero inoxidable para panel de protección para cristal o acrílico para paneles con un espesor máximo de 10 mm.

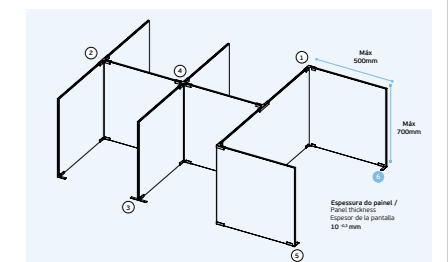
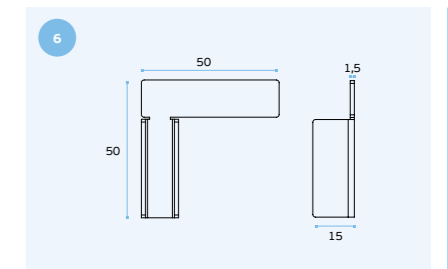
**MATERIAL:** EN 1.4301 / AISI 304**ACABAMENTO / FINISH / ACABADO**
STANDARD: SATINADO / SATIN

NEW

IN.80.031

Suporte em aço inoxidável para painel de proteção para vidro ou acrílico. Para painéis com a espessura máxima de 10mm /
Screen protection support in stainless steel for glass or acrylic. For panels with a maximum thickness of 10mm
Soporte en acero inoxidable para panel de protección para cristal o acrílico para paneles con un espesor máximo de 10 mm.

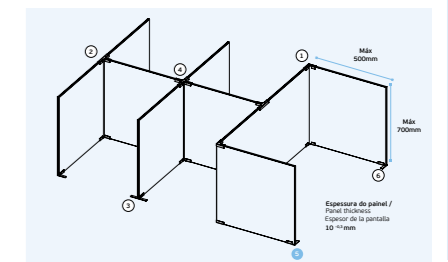
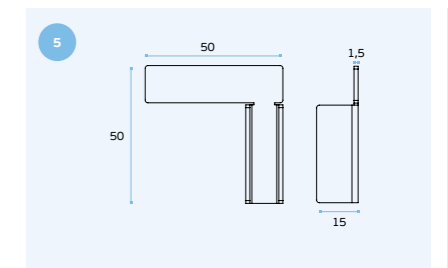
**MATERIAL:** EN 1.4301 / AISI 304**ACABAMENTO / FINISH / ACABADO**
STANDARD: SATINADO / SATIN

BARREIRAS DE CONFINAMENTO

CONTAINMENT BARRIER / BARRERA DE CONTENCIÓN

NEW

IN.80.022

Suporte em aço inoxidável para painel de proteção para vidro ou acrílico. Para painéis com a espessura máxima de 10mm /
Screen protection support in stainless steel for glass or acrylic. For panels with a maximum thickness of 10mm /
Soporte en acero inoxidable para panel de protección para cristal o acrílico Para paneles con un espesor máximo de 10 mm.



MATERIAL: EN 1.4301 / AISI 304

ACABAMENTO / FINISH / ACABADO STANDARD: SATINADO / SATIN

NEW

IN.80.023

Suporte em aço inoxidável para painel de proteção para vidro ou acrílico. Para painéis com a espessura máxima de 10mm /
Screen protection support in stainless steel for glass or acrylic. For panels with a maximum thickness of 10mm /
Soporte en acero inoxidable para panel de protección para cristal o acrílico Para paneles con un espesor máximo de 10 mm.



MATERIAL: EN 1.4301 / AISI 304

ACABAMENTO / FINISH / ACABADO STANDARD: SATINADO / SATIN

NEW

IN.80.028

Suporte em aço inoxidável para painel de proteção para vidro ou acrílico. Para painéis com a espessura máxima de 10mm /
Screen protection support in stainless steel for glass or acrylic. For panels with a maximum thickness of 10mm /
Soporte en acero inoxidable para panel de protección para cristal o acrílico Para paneles con un espesor máximo de 10 mm.



MATERIAL: EN 1.4301 / AISI 304

ACABAMENTO / FINISH / ACABADO STANDARD: SATINADO / SATIN

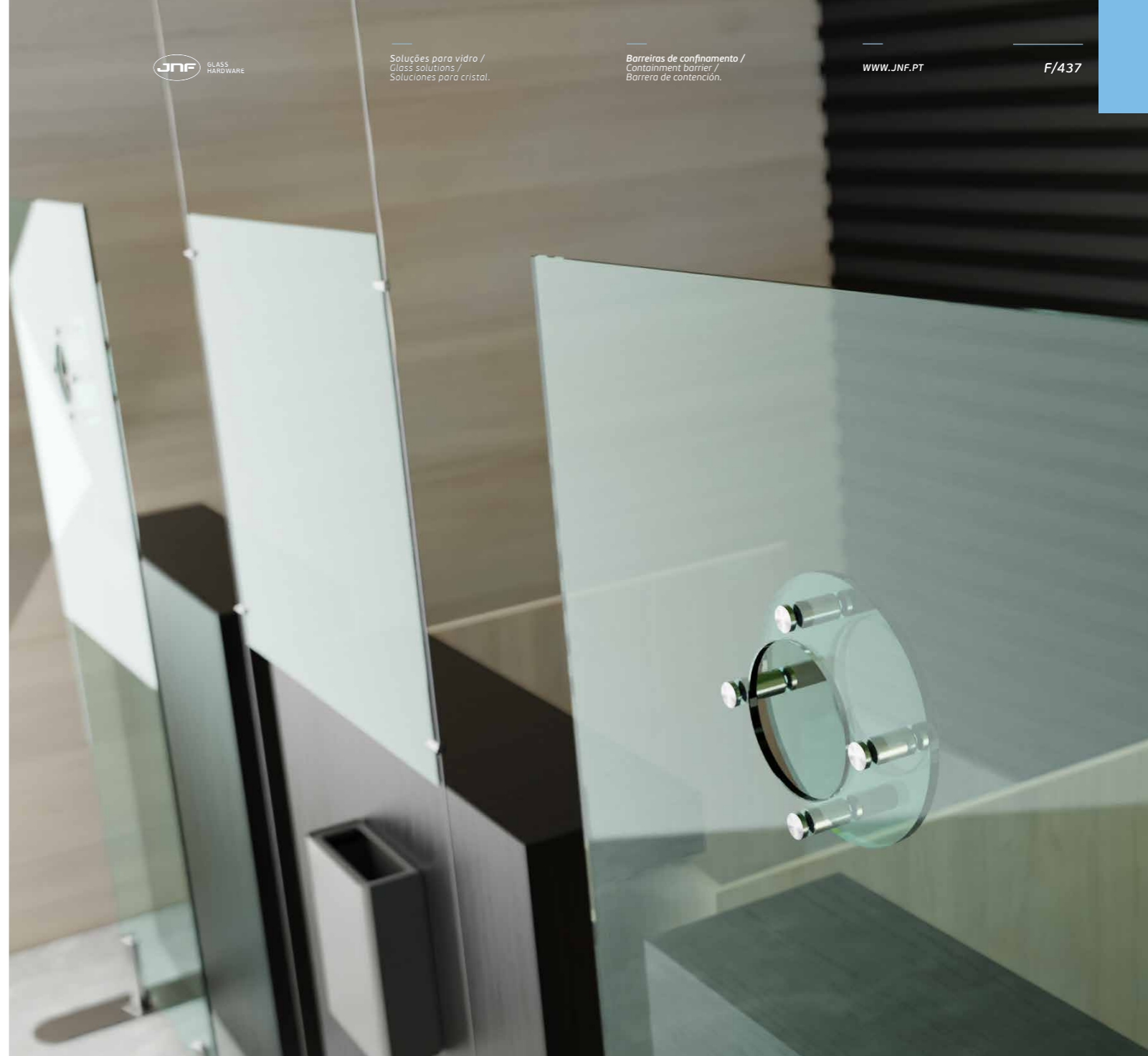
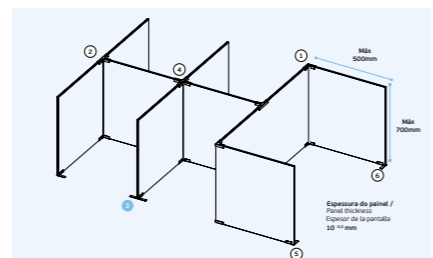
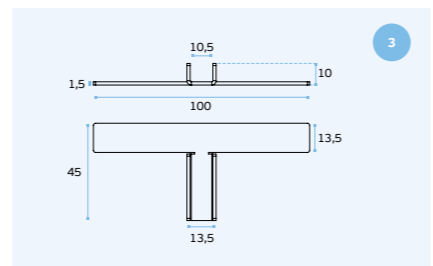
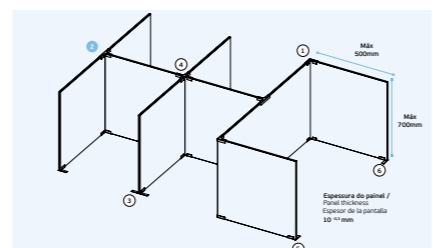
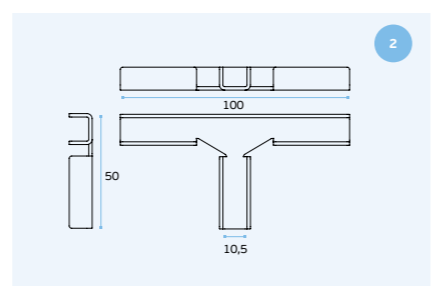
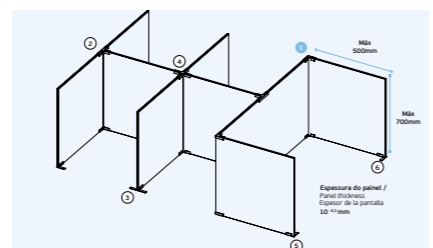
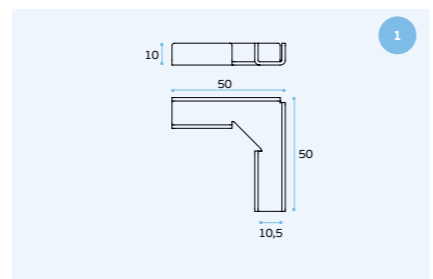

NEW

IN.80.105.D

Suporte duplo em aço inoxidável para painel de proteção para vidro ou acrílico (40mm) /
Double screen protection support in stainless steel for glass or acrylic (40mm) /
Soporte doble en acero inoxidable para panel de protección para cristal o acrílico (40mm).



MATERIAL: EN 1.4301 / AISI 304

ACABAMENTO / FINISH / ACABADO STANDARD: SATINADO / SATIN

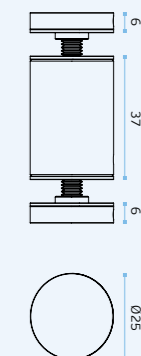

SISTEMA DE FIXAÇÃO PARA ALPENDRES DE VIDRO / GLASS CANOPIES SYSTEM / SISTEMA PARA CUBIERTA EN CRISTAL.

GLASS CANOPIES SYSTEM

AS COBERTURAS DE ALPENDRE DE VIDRO SÃO PROJETADAS PARA CRIAR ABRIGO SEM BLOQUEAR A LUZ DO DIA OU OBSTRUIR A ARQUITETURA CIRCUNDANTE. PRODUZIDAS EM AÇO INOXIDÁVEL E PREPARADAS PARA SER USADAS COM VIDRO TEMPERADO OU LAMINADO.

GLASS FRAMELESS CANOPIES ARE DESIGNED TO CREATE SHELTER WITHOUT BLOCKING DAYLIGHT OR OBSTRUCT THE SURROUNDING ARCHITECTURE. PRODUCED IN STAINLESS STEEL, AND PREPARED TO BE USED WITH TEMPERED OR LAMINATED GLASS.

LAS CUBIERTAS DE PORCHE DE CRISTAL ESTÁN DISEÑADAS PARA CREAR REFUGIO SIN BLOQUEAR LA LUZ DEL DÍA NI OBSTRUIR LA ARQUITECTURA CIRCUNDANTE. PRODUCIDOS EN ACERO INOXIDABLE Y PREPARADOS PARA SER UTILIZADOS CON CRISTAL TEMPLADO O LAMINADO.

IN.81.701
 Sistema de fixação para alpendres
 de vidro (x1 suporte) /
 Glass canopies system set.
 (x1 support) /
 Sistema para cubierta en cristal.
 (x1 soporte).



GC111
 glass
 cut

MATERIAL: EN 1.4301 / AISI 304

ACABAMENTO / FINISH / ACABADO STANDARD: SATINADO / SATIN / SATIN

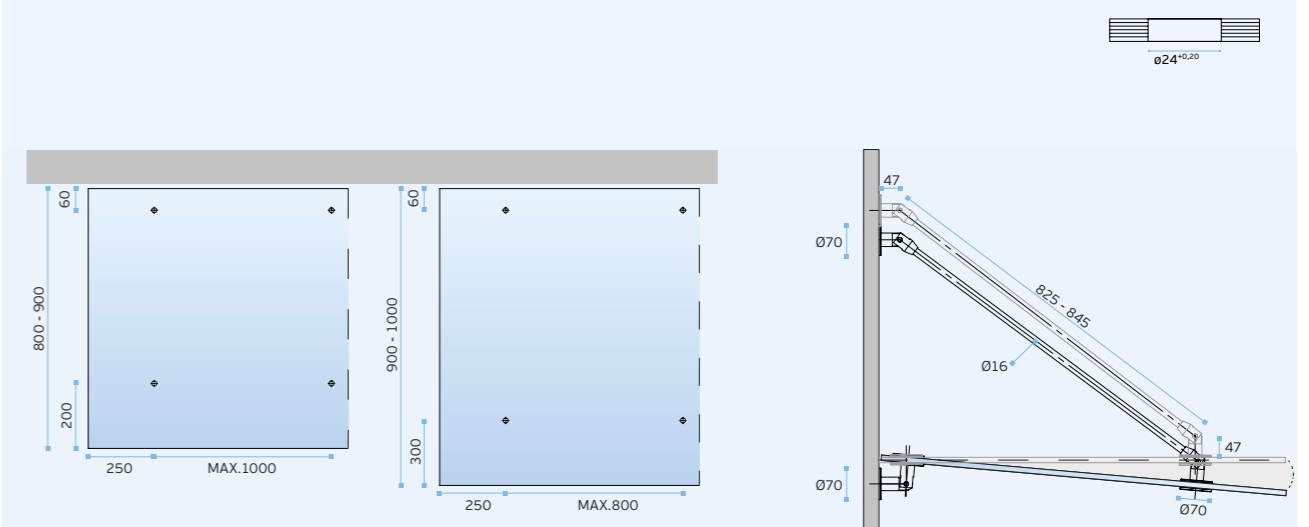

SISTEMA DE FIXAÇÃO PARA ALPENDRES DE VIDRO / GLASS CANOPIES SYSTEM / SISTEMA PARA CUBIERTA EN CRISTAL.

**IN.81.700.K**

Sistema de fixação para alpendres de vidro (x2 suportes) /
 Glass canopies system set. (x2 supports) /
 Sistema para cubierta en cristal. (x2 soportes).



MATERIAL: EN 1.4301 / AISI 304

ACABAMENTO / FINISH / ACABADO STANDARD: SATINADO / SATIN / SATIN

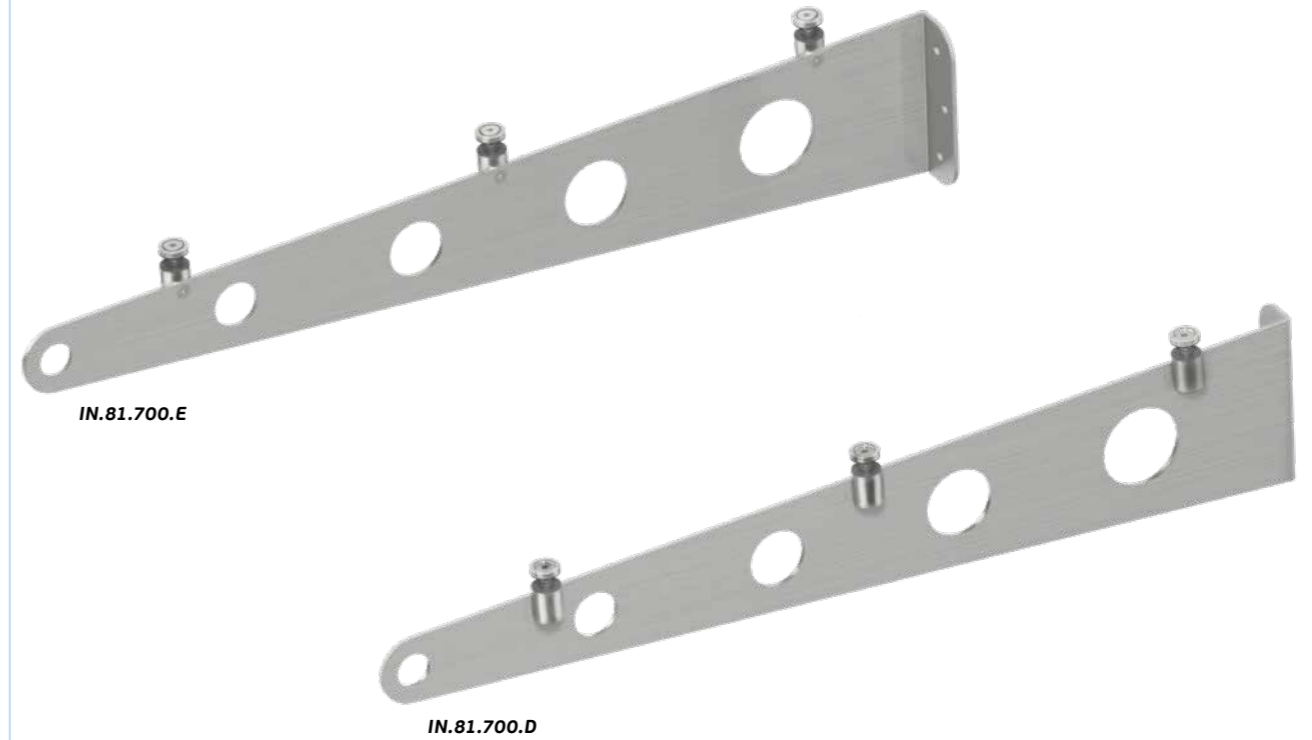
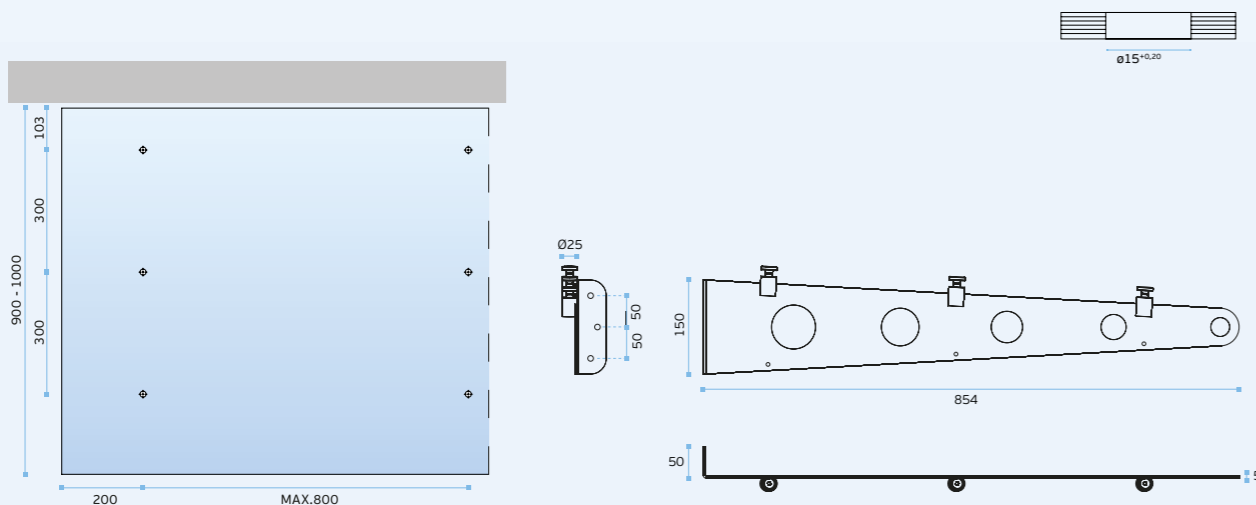
**IN.81.700.D
 IN.81.700.E**

Sistema de fixação para alpendres de vidro (x1 suporte direito ou esquerdo) /
 Glass canopies system set. (x1 right or left hand support) /
 Sistema para cubierta en cristal. (x1 soporte derecho o izquierdo).



MATERIAL: EN 1.4301 / AISI 304

ACABAMENTO / FINISH / ACABADO STANDARD: SATINADO / SATIN / SATIN

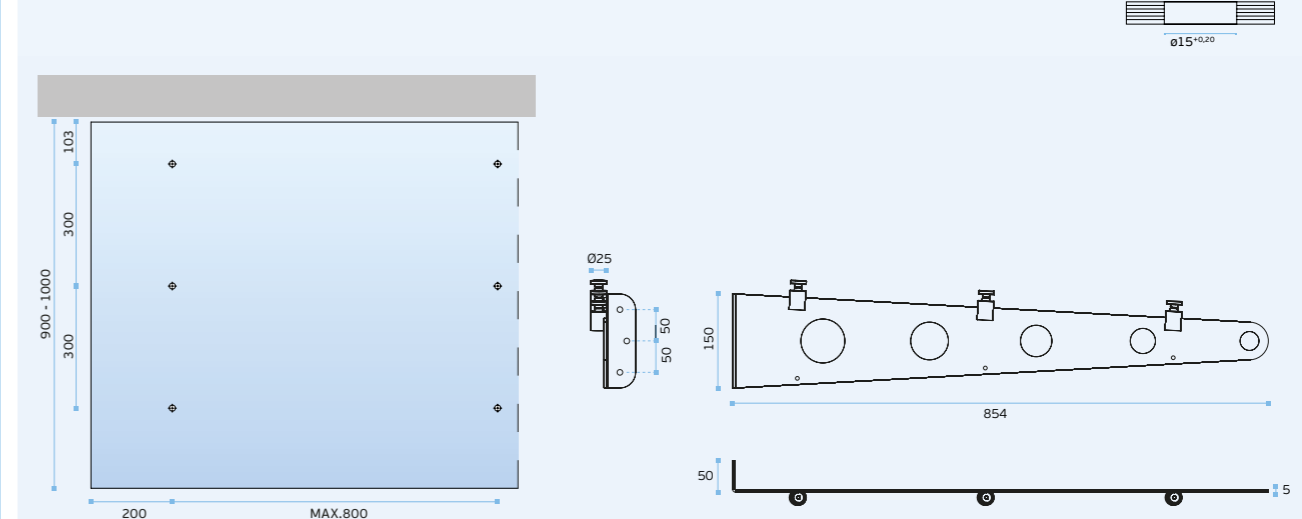

SUPTORES PARA VIDRO / GLASS SUPPORTS / SOPORTES PARA CRISTAL



IN.18.135
Suportes de corrimão para vidro / Hand rail support for glass / Soporte pasamanos para cristal.

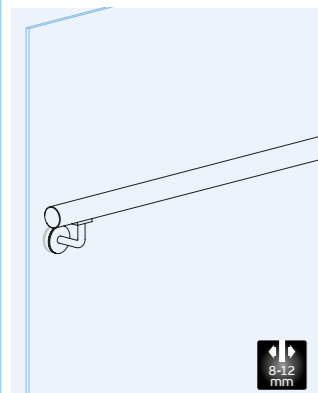

MATERIAL: EN 1.4301 / AISI 304
ACABAMENTO / FINISH / ACABADO: STANDARD: SATINADO / SATIN / SATIN

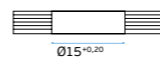
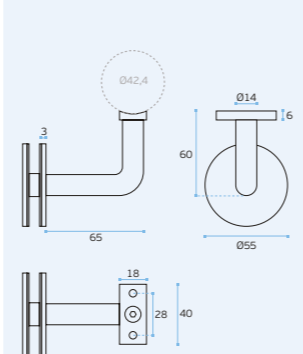

IN.70.100.
Suportes para prateleira / Shelf support / Soportes para bandeja.



MATERIAL: EN 1.4301 / AISI 304
ACABAMENTO / FINISH / ACABADO: STANDARD: SATINADO / SATIN / SATIN

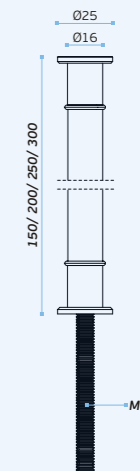

IN.18.136
Suportes de corrimão para vidro / Hand rail support for glass / Soporte pasamanos para cristal.

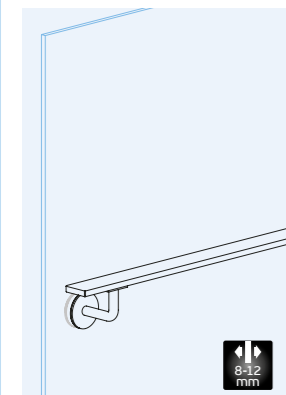

MATERIAL: EN 1.4301 / AISI 304
ACABAMENTO / FINISH / ACABADO: STANDARD: SATINADO / SATIN / SATIN

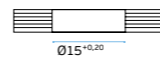
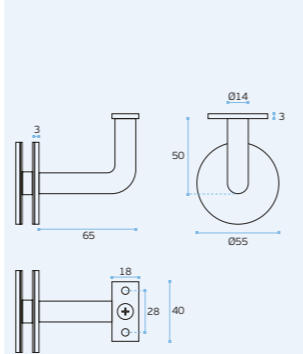

IN.70.100.300

IN.70.100.250

IN.70.100.200

IN.70.100.150

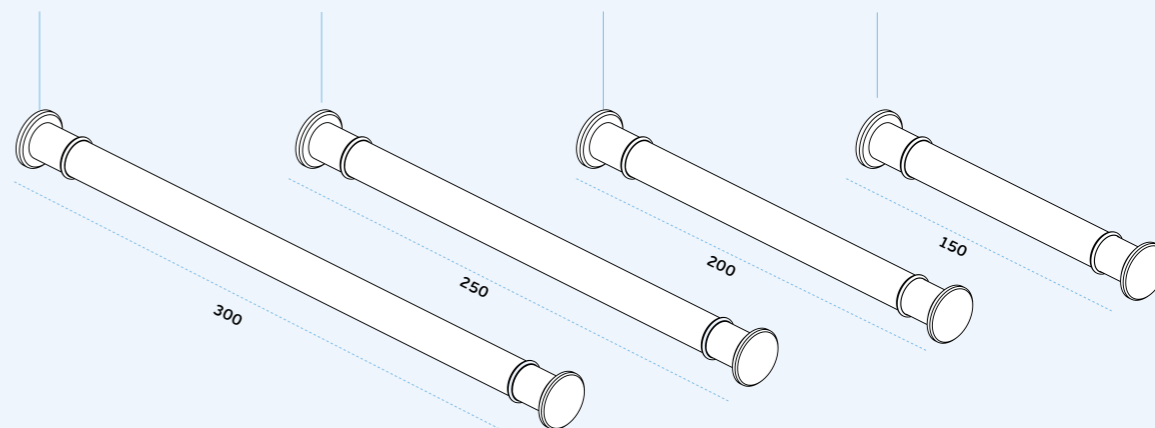

FERRAGENS PARA VITRINES / SHOWCASE HARDWARE / HERRAJES PARA VITRINA.

IN.81.502 Pivot para vitrine / Showcase pivot / Pivote para vitrina.

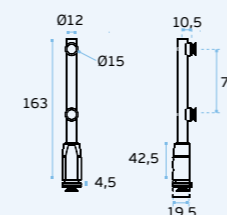

MATERIAL: EN 1.4301 / AISI 304

ACABAMENTO / FINISH / ACABADO
STANDARD: SATINADO / SATIN / SATIN

IN.81.500 Dobradiça de vitrine para aplicar com cola UV / Showcase hinge to use with UV glue / Bisagra para vitrina para aplicar con pegamento UV.

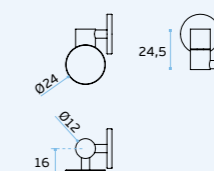

MATERIAL: EN 1.4301 / AISI 304

ACABAMENTO / FINISH / ACABADO
STANDARD: SATINADO / SATIN / SATIN

IN.81.501.20 Dobradiça de vitrine para aplicar com cola UV na porta./ Vitrine hinge to use with UV glue in the door / Bisagra para vitrina para aplicar con pegamento UV en la puerta.

Carga máx/
Max weight/ Peso max: **10kg**

Largura máx/ Max width/ largura
max: 400mm

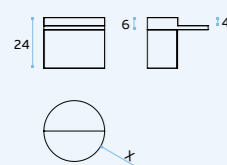

MATERIAL: EN 1.4301 / AISI 304

ACABAMENTO / FINISH / ACABADO
STANDARD: SATINADO / SATIN / SATIN

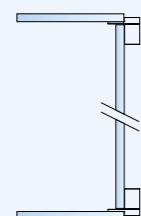

IN.81.501.F.20 Dobradiça de vitrine para aplicar com cola UV na porta./ Vitrine hinge to use with UV glue in the door / Bisagra para vitrina para aplicar con pegamento UV en la puerta.

Carga máx/
Max weight/ Peso max: **10kg**

Largura máx/ Max width/ largura
max: 400mm

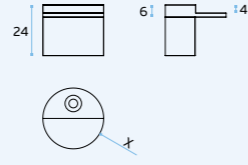

MATERIAL: EN 1.4301 / AISI 304

ACABAMENTO / FINISH / ACABADO
STANDARD: SATINADO / SATIN / SATIN

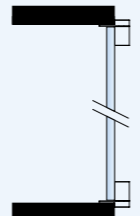

IN.20.07715 Fechadura com cilindro amovível / Lock with removable cylinder/ Cerradura con bombillo amovible.

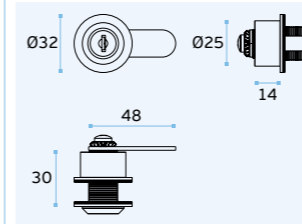

IN.20.07715.Q Fechadura com cilindro amovível / Lock with removable cylinder/ Cerradura con bombillo amovible.

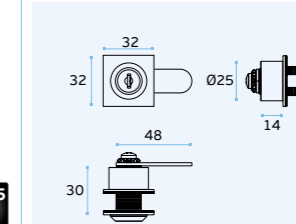

07715.C Cilindro amovível para fechadura IN.20.07715/ Removable cylinder for lock IN.20.07715/ Bombillo amovible para cerradura IN.20.07715.

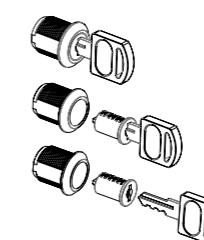

07715.CM Chave mestra / Master key / Llave mestra.



07715.CR Chave para remoção do cilindro. / Cylinder changing key. / Llave para quitar el bombillo.



SUportes PARA VIDRO / GLASS SUPPORTS / SOPORTES PARA CRISTAL

IN.80.560.B
 Acessório para IN.80.560 /
 Accessory for IN.80.560 /
 Accesorio para IN.80.560.



MATERIAL: EN 1.4301 / AISI 304
ACABAMENTO / FINISH / ACABADO:
 SATINADO / SATIN / SATIN

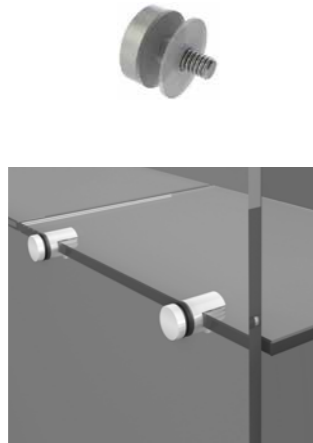
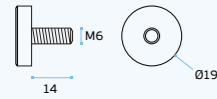

IN.80.560.6
 Suportes de vidro /
 Shelf support /
 Soportes de estantes.



MATERIAL: EN 1.4301 / AISI 304
ACABAMENTO / FINISH / ACABADO:
 SATINADO / SATIN / SATIN

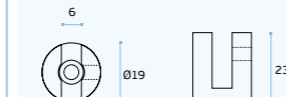

IN.80.560.8
 Suportes de vidro /
 Shelf support /
 Soportes de estantes.



MATERIAL: EN 1.4301 / AISI 304
ACABAMENTO / FINISH / ACABADO:
 SATINADO / SATIN / SATIN

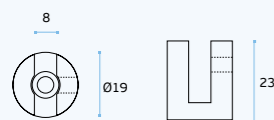

IN.80.700
 Suportes de vidro /
 Shelf support /
 Soportes de estantes.



MATERIAL: EN 1.4301 / AISI 304
ACABAMENTO / FINISH / ACABADO:
 SATINADO / SATIN / SATIN

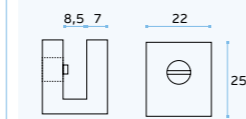

IN.10.202
 Cabo de aço /
 Stainless steel wire rope /
 Cable de acero inox.



REF	Ø MM	MÁX CARGA / LOAD	MEDIDA / SIZE
IN.10.202	2,5mm	373 kg	100m



MATERIAL: EN 1.4401 / AISI 316

IN.10.203
 Cabo de aço /
 Stainless steel wire rope /
 Cable de acero inox.



REF	Ø MM	MÁX CARGA / LOAD	MEDIDA / SIZE
IN.10.203	3mm	571 kg	



MATERIAL: EN 1.4401 / AISI 316

- 2,5 mm
- 3 mm
- 4 mm
- 6 mm
- 8 mm

IN.10.715
 Suporte e esticador articulado /
 Articulated support /
 Soporte articulado

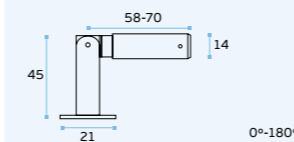

MATERIAL: EN 1.4301 / AISI 304
ACABAMENTO / FINISH / ACABADO:
 SATINADO / SATIN



IN.10.716
 Suporte e esticador /
 Support and tensioner /
 Soporte y tensor.

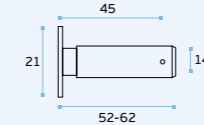

MATERIAL: EN 1.4301 / AISI 304
ACABAMENTO / FINISH / ACABADO:
 SATINADO / SATIN



BATENTES PARA PORTAS DE VIDRO / DOOR STOPPERS FOR GLASS DOORS / TOPES PARA PUERTAS DE CRISTAL.



.P
Mirror
finish

.TB
PVD
Titanium
black

.TG
PVD
Titanium
gold

.TCO
PVD
Titanium
copper

.TCH
PVD
Titanium
chocolate

IN.13.356
Batente de chão /
Door stopper /
Tope de puerta

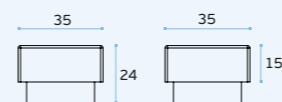

MATERIAL: EN 1.4301 / AISI 304

ACABAMENTO / FINISH / ACABADO:
SATINADO / SATIN

OPCIONAL / OPTIONAL:
POLIDO / POLISHED / PULIDO

OPCIONAL / OPTIONAL: PVD TITANIUM

IN.13.355 DUO
Batente de chão /
Door stopper /
Tope de puerta

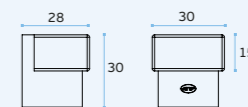

MATERIAL: EN 1.4301 / AISI 304

ACABAMENTO / FINISH / ACABADO:
SATINADO / SATIN

OPCIONAL / OPTIONAL:
POLIDO / POLISHED / PULIDO

NEW

IN.13.357
Batente de chão /
Door stopper /
Tope de puerta.

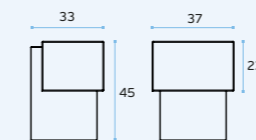

MATERIAL: EN 1.4301 / AISI 304

ACABAMENTO / FINISH / ACABADO:
SATINADO / SATIN

NEW

IN.13.358
Batente de chão /
Door stopper /
Tope de puerta.

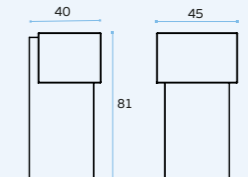

MATERIAL: EN 1.4301 / AISI 304

ACABAMENTO / FINISH / ACABADO:
SATINADO / SATIN

IN.13.185.30 LOFT
Batente de chão /
Door stopper /
Tope de puerta.
Design: Christian Magalhães

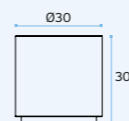

MATERIAL: EN 1.4301 / AISI 304

ACABAMENTO / FINISH / ACABADO:
SATINADO / SATIN

OPCIONAL / OPTIONAL:
POLIDO / POLISHED / PULIDO

OPCIONAL / OPTIONAL: PVD TITANIUM

IN.13.185.50 LOFT
Batente de chão /
Door stopper /
Tope de puerta.
Design: Christian Magalhães

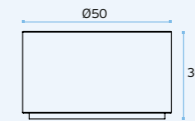

MATERIAL: EN 1.4301 / AISI 304

ACABAMENTO / FINISH / ACABADO:
SATINADO / SATIN

OPCIONAL / OPTIONAL:
POLIDO / POLISHED / PULIDO

OPCIONAL / OPTIONAL: PVD TITANIUM

BATENTES PARA PORTAS DE VIDRO / DOOR STOPPERS FOR GLASS DOORS / TOPES PARA PUERTAS DE CRISTAL.

IN.13.008
Batente de chão / Door stopper / Tope de puerta.
Design: Miguel Vasconcelos



- .P
- .TB
- .TG
- .TCO
- .TCH

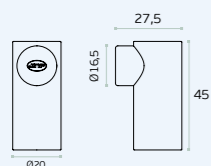

MATERIAL: EN 1.4301 / AISI 304
ACABAMENTO / FINISH / ACABADO: SATINADO / SATIN
OPCIONAL / OPTIONAL: POLIDO / POLISHED / PULIDO
OPCIONAL / OPTIONAL: PVD TITANIUM

IN.13.187
Batente de porta com retenção magnética para porta em vidro / Door stopper with magnetic holder for glass door / Tope de puerta con retenedor magnetico para puerta en cristal.

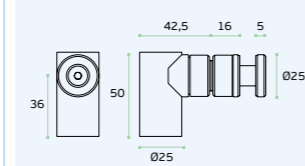

MATERIAL: EN 1.4301 / AISI 304
ACABAMENTO / FINISH / ACABADO: SATINADO / SATIN

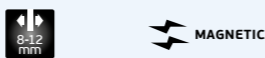

.P
Mirror finish

.TB
PVD Titanium black

.TG
PVD Titanium gold

.TCO
PVD Titanium copper

.TCH
PVD Titanium chocolate

.P
Mirror finish

.TB
PVD Titanium black

.TG
PVD Titanium gold

.TCO
PVD Titanium copper

.TCH
PVD Titanium chocolate

NEW

IN.13.003
Batente de chão / Door stopper / Tope de puerta.

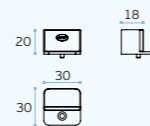

MATERIAL: EN 1.4301 / AISI 304
ACABAMENTO / FINISH / ACABADO: SATINADO / SATIN

NEW

IN.13.002
Batente de chão / Door stopper / Tope de puerta.

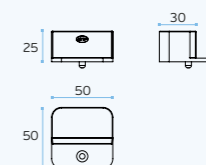

MATERIAL: EN 1.4301 / AISI 304
ACABAMENTO / FINISH / ACABADO: SATINADO / SATIN

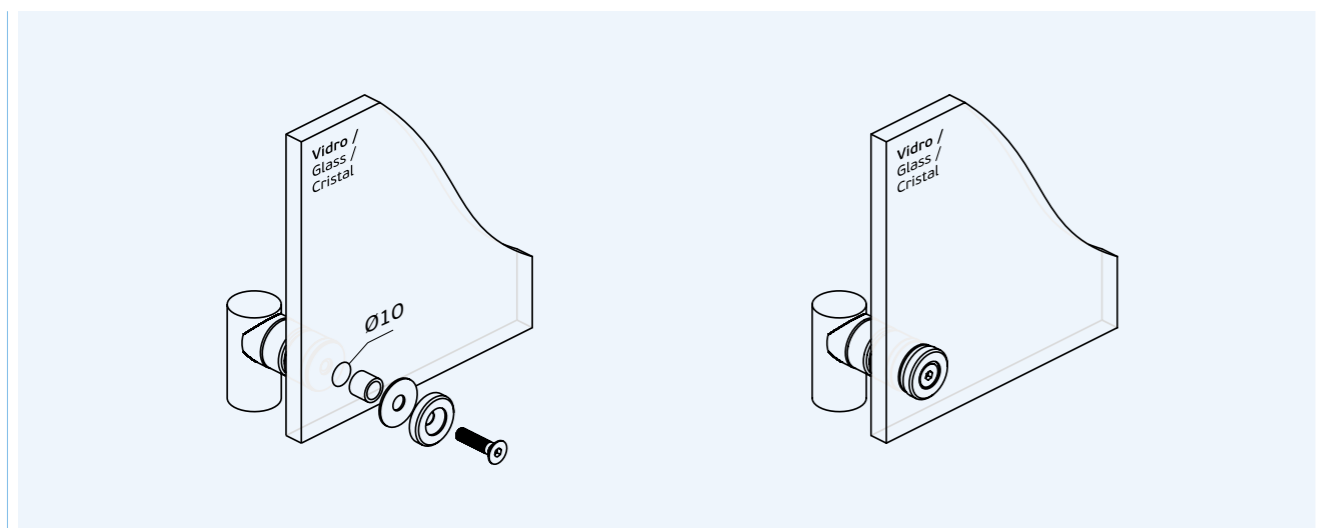

IN.13.005
Batente de chão / Door stopper / Tope de puerta.
Design: Miguel Vasconcelos

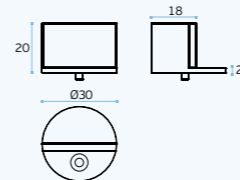

MATERIAL: EN 1.4301 / AISI 304
ACABAMENTO / FINISH / ACABADO: SATINADO / SATIN

IN.13.004
Batente de chão / Door stopper / Tope de puerta.
Design: Miguel Vasconcelos

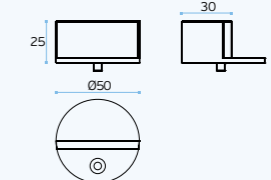

MATERIAL: EN 1.4301 / AISI 304
ACABAMENTO / FINISH / ACABADO: SATINADO / SATIN

IN.13.112.10
Batente de porta para colar no vidro / Door stopper for glass fixing / Tope de puerta para fijar en cristal.



- .P
- .TB
- .TG
- .TCO
- .TCH

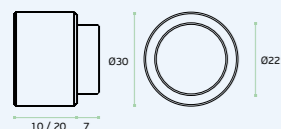

MATERIAL: EN 1.4301 / AISI 304
ACABAMENTO / FINISH / ACABADO: SATINADO / SATIN
OPCIONAL / OPTIONAL: POLIDO / POLISHED / PULIDO
OPCIONAL / OPTIONAL: PVD TITANIUM



IN.13.112.20
Batente de porta para colar no vidro / Door stopper for glass fixing / Tope de puerta para fijar en cristal.



- .P
- .TB
- .TG
- .TCO
- .TCH

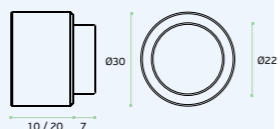

MATERIAL: EN 1.4301 / AISI 304
ACABAMENTO / FINISH / ACABADO: SATINADO / SATIN
OPCIONAL / OPTIONAL: POLIDO / POLISHED / PULIDO
OPCIONAL / OPTIONAL: PVD TITANIUM



RR.13.005 SIMPULL PUSH
Batente de chão / Door stopper / Tope de puerta.
Design: Rita Rodrigues



MATERIAL: EN 1.4301 / AISI 304
ACABAMENTO / FINISH / ACABADO: SATINADO / SATIN

IN.23.009
Retenedor de porta / Door holder / Retenedor de puerta.
Design: Miguel Vasconcelos

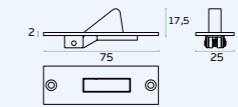
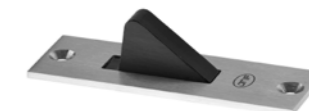

MATERIAL: EN 1.4301 / AISI 304
ACABAMENTO / FINISH / ACABADO: SATINADO / SATIN

CABIDES /
HOOKS /
PERCHAS



IN.14.510.G
Cabide para vidro com adesivo / Hook for glass with special sticker / Percha para cristal con pegamiento.

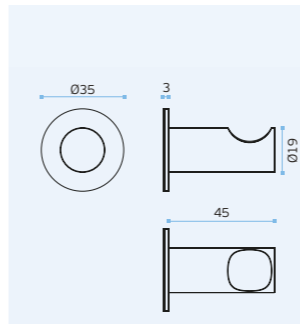

MATERIAL: EN 1.4301 / AISI 304

ACABAMENTO / FINISH / ACABADO:
STANDARD: SATINADO / SATIN / SATIN

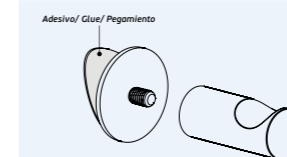

IN.14.510.V
Cabide para vidro / Hook for glass / Percha para cristal.

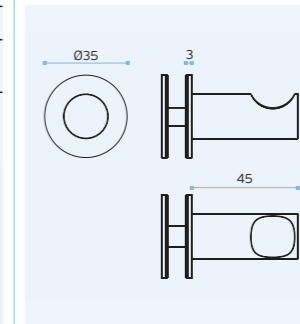

MATERIAL: EN 1.4301 / AISI 304

ACABAMENTO / FINISH / ACABADO:
STANDARD: SATINADO / SATIN / SATIN

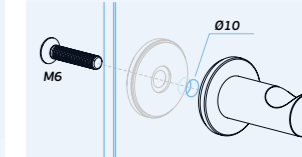

IN.14.501.G
Cabide para vidro com adesivo / Hook for glass with special sticker / Percha para cristal con pegamiento.

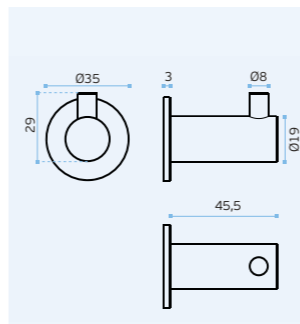

MATERIAL: EN 1.4301 / AISI 304

ACABAMENTO / FINISH / ACABADO:
STANDARD: SATINADO / SATIN / SATIN

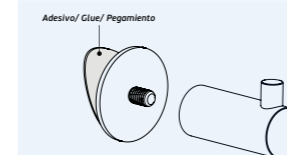

IN.14.501.V
Cabide para vidro / Hook for glass / Percha para cristal.

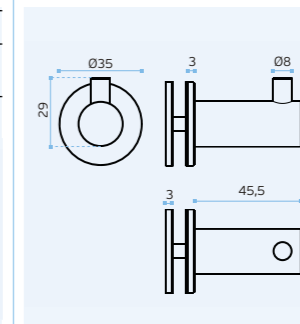

MATERIAL: EN 1.4301 / AISI 304

ACABAMENTO / FINISH / ACABADO:
STANDARD: SATINADO / SATIN / SATIN

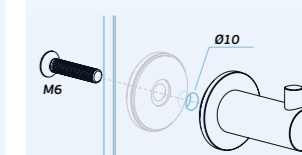

CABIDES / HOOKS / PERCHAS

IN.14.520.3.G
Cabide triplo com adesivo /
Triple hook with glue /
Percha triple con pegamiento.



MATERIAL: EN 1.4301 / AISI 304

ACABAMENTO / FINISH / ACABADO:
STANDARD: SATINADO / SATIN / SATIN

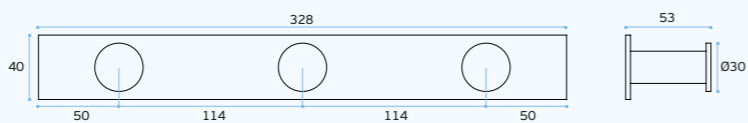
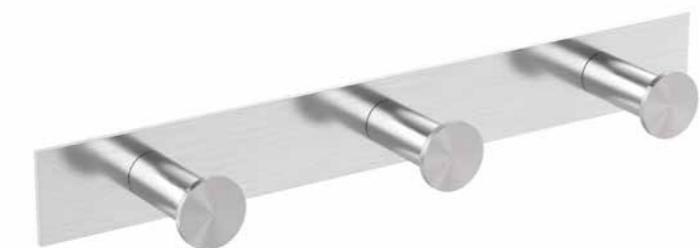

IN.14.505.3.G
Cabide triplo com adesivo /
Triple hook with glue /
Percha triple con pegamiento.



MATERIAL: EN 1.4301 / AISI 304

ACABAMENTO / FINISH / ACABADO:
STANDARD: SATINADO / SATIN / SATIN

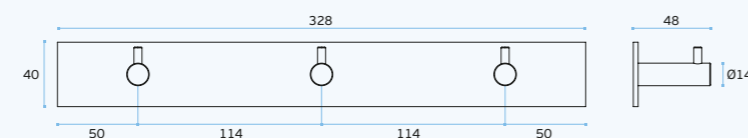

IN.14.506.3.G
Cabide triplo com adesivo /
Triple hook with glue /
Percha triple con pegamiento.



MATERIAL: EN 1.4301 / AISI 304

ACABAMENTO / FINISH / ACABADO:
STANDARD: SATINADO / SATIN / SATIN

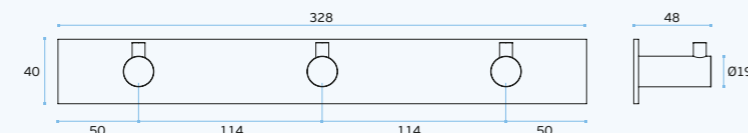

IN.14.600.G
Cabide quadruplo com adesivo /
Quadruple hook with glue /
Percha quadruplo con pegamiento.



MATERIAL: EN 1.4301 / AISI 304

ACABAMENTO / FINISH / ACABADO:
STANDARD: SATINADO / SATIN / SATIN

OPTIONAL: PVD TITANIUM COATED

.TB / .TG / .TCO / .TCH

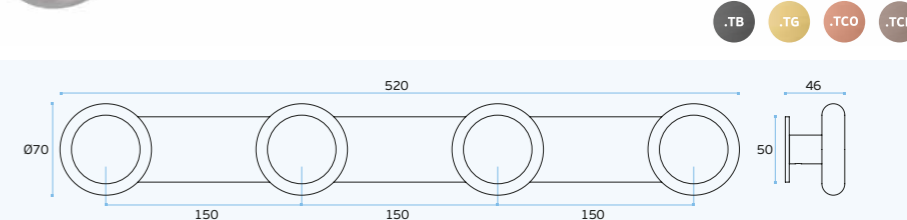

IN.14.177.3.G
Cabide triplo com adesivo /
Triple hook with glue /
Percha triple con pegamiento.



MATERIAL: EN 1.4301 / AISI 304

ACABAMENTO / FINISH / ACABADO:
STANDARD: SATINADO / SATIN / SATIN

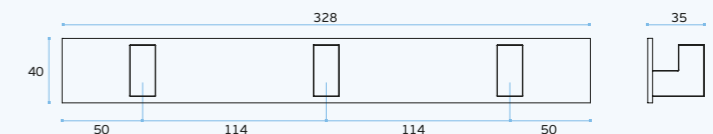
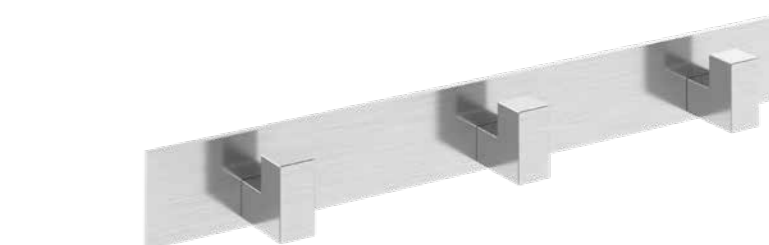

AM.14.012.G
Cabide triplo com adesivo /
Triple hook with glue /
Percha triple con pegamiento.



MATERIAL: EN 1.4301 / AISI 304

ACABAMENTO / FINISH / ACABADO:
STANDARD: SATINADO / SATIN / SATIN

DESIGN: ANA MOREIRA

