

FREELINE

BY JNF

YOUR FREEDOM
HARDWARE

www.freelinebyjnf.com



FREELINE
YOUR FREEDOM
HARDWARE.



ABOUT FREELINE BRAND

YOUR FREEDOM HARDWARE.

PT

Freeline by JNF é uma gama de produtos que resolvem as solicitações diárias mais comuns de ferragens e acessórios.

São um grupo de produtos de uso fácil, com desenho contemporâneo que se adapta discretamente a muitas decorações.

A nível técnico, são acessórios de fácil instalação, usando materiais duráveis adequados à maioria das aplicações habitacionais. A grande maioria pode ser instalado a nível do "Bricolage" sem grandes exigências técnicas.

Os elementos mecânicos foram desenvolvidos pela JNF tendo passado os testes alvo que se situam num grau de utilização diário, estando incluídos no grupo de ferragens para uso em instalações sujeitas a actividade frequente.

A matéria prima é o aço inoxidável, um material muito resistente à corrosão que permite muitos acabamentos superficiais, desde o satinado até ao PVD Titanium decorativo nas cores negro e dourado mate.

Também apresentamos outros acabamentos que são uma tendência na decoração, como o RAW que é um aço inox "envelhecido" ou o Raw Black, negro envelhecido, o RAW Gold, ouro envelhecido e Raw Copper, cobre envelhecido.

O acabamento PVD Titanium da linha FREELINE é um tratamento de superfície não galvânico decorativo com uma espessura de titânio entre 0,8 e 1,0 micron.

Os acabamentos RAW Black, Gold e Copper são tratamentos de superfície galvânicos.

O acabamento RAW é um tratamento de superfície apenas mecânico que confere uma aparência de "usado".

EN

Freeline by JNF is a range of products that solve the most common daily requests for hardware and accessories.

It is a group of easy-to-use products, with a contemporary design that adapts to many discreet decorations.

On a technical level, they are easy-to-install, using durable materials suitable for most residential applications. The great majority can be installed at DIY level without great technical demands.

The mechanical elements have been developed by JNF having passed the target tests which are in a daily rate of use, being included in the group of fittings for installations subject to frequent activity.

The raw material is stainless steel, which is very resistant to corrosion and allows many surface finishes, from satin to Titanium PVD decorative in black and gold matte colours.

We also present other finishes that are a trend in decoration, such as RAW which is a "aged" stainless steel or Raw Black, aged black, RAW Gold, aged gold and Raw Copper, aged copper.

The TITANIUM PVD finish of the FREELINE line is a non-galvanic decorative surface treatment with a titanium thickness between 0,8 and 1,0 micron.

The RAW Black, Gold and Copper finishes are galvanic surface treatments.

The RAW finish is a mechanical-only surface treatment that gives a "used" appearance.

ES

Freeline by JNF es una gama de productos que resuelve las demandas diarias más comunes de herrajes y accesorios.

Son un grupo de productos fáciles de usar, con un diseño contemporáneo que se adaptan de forma discreta a muchas decoraciones.

Desde el punto de vista técnico, se trata de accesorios fáciles de instalar, con materiales duraderos y adecuados para la mayoría de las aplicaciones residenciales. La gran mayoría puede instalarse a nivel de bricolaje sin grandes exigencias técnicas.

Los elementos mecánicos han sido desarrollados por JNF habiendo superado las pruebas de destino que se encuentran en un grado de uso diario, incluyéndose en el grupo de accesorios para uso frecuente.

La materia prima es el acero inoxidable, un material muy resistente a la corrosión que permite muchos acabados superficiales, desde el satinado hasta el PVD Titanium decorativo en colores negro y dorado mate.

También presentamos otros acabados que son tendencia en decoración, como el RAW que es un acero inoxidable "envejecido" o el Raw Black, negro envejecido, el RAW Gold, oro envejecido y el Raw Copper, cobre envejecido.

El acabado PVD Titanium de la gama FREELINE es un tratamiento de superficie decorativo no galvánico con un espesor de titanio de entre 0,8 y 1,0 micras.

Los acabados RAW Black, Gold y Copper son tratamientos superficiales galvánicos.

El acabado RAW es un tratamiento superficial sólo mecánico que da un aspecto "usado".

ECO-FRIENDLY PACKAGING



PT

O descartável não é sustentável.

A embalagem dos produtos FREELINE by JNF foi desenhada com o objectivo de produzir o menor impacto ambiental.

Usa fundamentalmente cartão reciclado, ou reciclável, de origem sustentável.

Evitamos usar papéis impressos com tintas não recicláveis.

O plástico de uso único foi quase totalmente eliminado, só é utilizado quando não existe alternativa viável.

A embalagem foi pensada de forma a ocupar volumetricamente o mínimo espaço para que o seu transporte tenha muito pouca expressão em custos e gastos de combustível.

Embora seja uma embalagem apelativa, exprime-se com sobriedade não sendo exuberante, criando uma empatia natural com o utilizador e principalmente com o meio ambiente.

Obrigado por ser sensível e por aceitar esta nova forma de interpretar a embalagem amiga do ambiente, ficamos muito satisfeitos por saber que as nossas embalagens têm muito pouco impacto negativo.

EN

Disposable is not sustainable.

The packaging of FREELINE by JNF products has been designed with the aim of producing the lowest environmental impact.

It uses primarily recycled, or recyclable, cardboard from sustainable sources.

We avoid using paper printed with non-recyclable inks.

Single-use plastic has been almost completely eliminated, it is only used when there is no viable alternative.

The packaging has been designed to occupy the minimum space in terms of volume, so that its transport has very little impact on costs and fuel expenses.

Although it is an appealing package, it is expressed with sobriety, without being exuberant, creating a natural empathy with the user and especially with the environment.

Thank you for being sensitive and accepting this new way of interpreting environmentally friendly packaging, we are very pleased to know that our packaging has very little negative impact.

ES

Lo desechable no es sostenible.

Los envases de los productos FREELINE by JNF se han diseñado con el objetivo de producir el menor impacto medioambiental.

Utiliza principalmente cartón reciclado, o reciclable, procedente de fuentes sostenibles.

Evitamos utilizar papel impreso con tintas no reciclables.

El plástico de un solo uso se ha eliminado casi por completo, sólo se utiliza cuando no hay una alternativa viable.

El envase se ha diseñado para que ocupe el mínimo espacio en términos de volumen, de modo que su transporte tenga muy poca repercusión en los costes y gastos de combustible.

Aunque es un paquete atractivo, se expresa con sobriedad, sin ser exuberante, creando una empatía natural con el usuario y, sobre todo, con el entorno.

Gracias por ser sensibles y aceptar esta nueva forma de interpretar los envases ecológicos, nos complace saber que nuestros envases tienen muy poco impacto negativo.

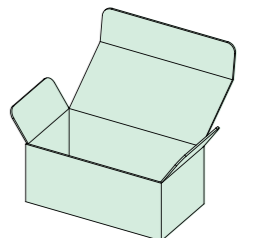
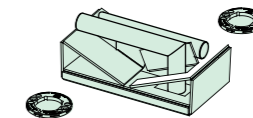
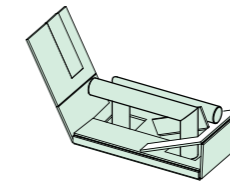
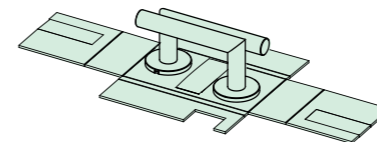

0

about
freeline
brand

Sobre
a marca
FREELINE \
Sobre
la marca
FREELINE

4

1

lever
handles+
accessories

Puxadores
de porta +
acessórios \
Manillas
de puerta +
accesorios

10

2

pull
handles

Asas
de porta \
Manillones
de puerta

110

3

hinges +
pivots

Dobradiças
+ pivots \
Bisagras
+ pivotes

112

4

furniture
hardware

Ferragens
para mobiliário \
Herrajes
para mueble

136

5

general
hardware

Ferragens
diversas \
Herrajes
diversos

166

6

glass
hardware

Ferragens
para vidro \
Herrajes
para cristal

222

7

sliding
door
systems

Sistemas de
portas de
correr \
Sistemas para
puertas
correderas

310

8

locking
systems

Sistemas
de fecho \
sistemas
de cierre

340

9

sanitary
booth
hardware

Sistemas
modulares
para cabines
sanitárias \
Herrajes para
cabinas
sanitarias

436

1

PUXADORES DE PORTA + ACESSÓRIOS

LEVER HANDLES + ACCESSORIES

MANILLAS DE PUERTA Y ACCESORIOS

1.1
ARTIC LINE
PUXADOR DE PORTA
DOOR HANDLE /
MANILLA DE PUERTA

1.2
SEVENTY LINE
PUXADOR DE PORTA
DOOR HANDLE /
MANILLA DE PUERTA

1.3
NEW DECOR LINE
PUXADOR DE PORTA
DOOR HANDLE /
MANILLA DE PUERTA

1.4
PUXADOR DE PORTA COM PLACA
DOOR HANDLE WITH PLATE /
MANILLA DE PUERTA CON PLACA

1.5
PUXADOR COM MECANISMO DK
LEVER HANDLE WITH DK
MECHANISM / MANILLA CON
MECANISMO DK.

1.6
**PUXADOR DE PORTA ROTATIVOS
E FIXOS | TURNING AND FIXED**
KNOBS | POMOS DE PUERTA
GIRATORIOS Y FIJOS.

1.7
FECHOS DE WC |
SNIB INDICATOR |
CONDENAS DE BAÑO

1.8
PROTECTORES DE CILINDRO
SECURITY HARDWARE |
HARDWARE DE SEGURIDAD

1.9
**CONCHAS DE EMBUTIR PARA
PORTAS E MOBILIÁRIO /**
FLUSH HANDLES FOR DOORS
AND FURNITURE / CAZOLETAS
DE EMBUTIR PARA PUERTAS Y
MUEBLES.



Arctic line

PT

*Coleção de puxadores com
desenho contemporâneo
de formas fluídas e
ergonómicas com
inspiração no design do
Norte da Europa.*

EN

*Collection of handles with
contemporary design of
fluid and ergonomic shapes
with inspiration in Northern
European design.*

ES

*Colección de manillas con un
diseño contemporáneo de
formas fluidas y ergonómicas
inspiradas en el diseño del
norte de Europa.*



p. 14 / **Flow**



p. 16 / **Bergen**



p. 18 / **Ninety**

*New
Rose only
5 mm with
spring*

NOVA ROSETA
APENAS 5mm
COM MOLA

NUEVA ROSETA
SÓLO 5mm
CON MUELLE



1/1 scale

Flow

Puxador muito ergonómico com uma escala correcta para a mão. Formas arredondadas muito fluidas com um nível estético bastante equilibrado.

Very ergonomic handle with a correct scale for the hand. Very fluid rounded shapes with a very balanced aesthetic level.

Manilla muy ergonómica con una escala correcta para la mano. Formas redondeadas muy fluidas con un nivel estético muy equilibrado.

IN.00.182.RF05N / Par

*Puxador de porta /
Lever handle /
Manilla de puerta.*

*Roseta standard 5mm /
5mm standard rose
RF05N*

*EN 1.4301 - AISI 304
Satinado / Satin / Satin*



1 Pr. 48 Pr.

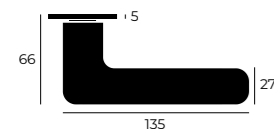

IN.04.116 / Set

*Fecho de casa de banho /
Bathroom snib indicator /
Condensa de baño.*



1 Set. 6 Set.



IN.04.REC.05N / Par

*Entrada de chave /
Key hole /
Bocallave para llave.*



IN.04.RPZ.05N / Par

*Entrada de chave cilindro europeu /
European cylinder key hole /
Bocallave para cilindro.*





Bergen

Forma robusta com um equilíbrio entre linhas rectas e curvas perfeito. Ao tacto é um puxador muito confortável.

Robust shape with a perfect balance between straight lines and curves. To the touch it is a very comfortable handle.

Forma robusta con un equilibrio perfecto entre líneas rectas y curvas. Una manilla muy cómoda al tacto.

IN.00.184.RF05N / Par

Puxador de porta /
Lever handle /
Manilla de puerta.

Roseta standard 5mm /
5mm standard rose
RF05N

EN 1.4301 - AISI 304
Satinado / Satin / Satin



1 Pr. 48 Pr.

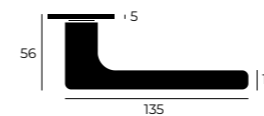

IN.04.116 / Set

Fecho de casa de banho /
Bathroom snib indicator /
Condensa de baño.



1 Set. 6 Set.



IN.04.REC.05N / Par

Entrada de chave /
Key hole /
Bocallave para llave.



IN.04.RPZ.05N / Par

Entrada de chave cilindro europeu /
European cylinder key hole /
Bocallave para cilindro.

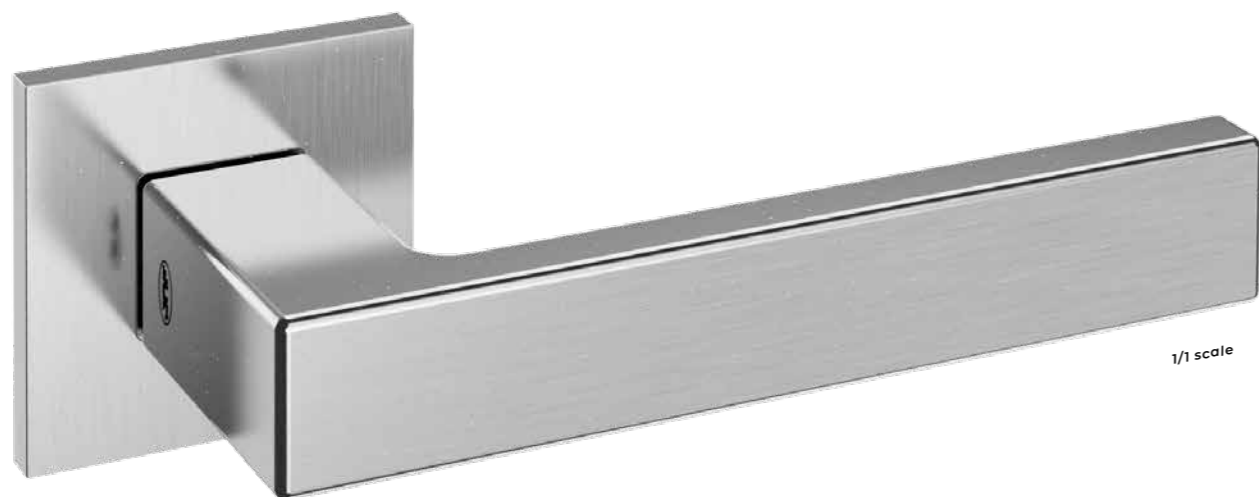

1/1 scale

Ninety

O puxador recto com as arestas redondas, que respeitam o conforto ao ser manipulado. Uma peça intemporal.

The lever handle with rounded edges, which respect the comfort of handling. A timeless piece.

La manilla recta con bordes redondeados, que respetan la comodidad de manejo. Una pieza atemporal.

IN.00.317.QF05N / Par

Puxador de porta /
Lever handle /
Manilla de puerta.

Roseta standard 5mm /
5mm standard rose
QF05N

EN 1.4301 - AISI 304
Satinado / Satin / Satin

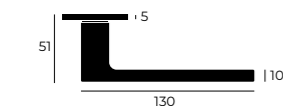

IN.04.117 / Set

Fecho de casa de banho /
Bathroom snib indicator /
Condena de baño.



IN.04.QEC.05N / Par

Entrada de chave /
Key hole /
Bocallave para llave.



IN.04.QPZ.05N / Par

Entrada de chave cilindro europeu /
European cylinder key hole /
Bocallave para cilindro.



*Titânio PVD decorativo
com uma tonalidade negra
inconfundível e durável.
A solução correcta para
acabamentos sobre um
material nobre como o
aço inoxidável.*

*Decorative PVD titanium
with an unmistakable and
durable black shade. The
correct solution for finishes
on a noble material such as
stainless steel.*

*Decorativo de titânio
PVD con un tono negro
inconfundible y duradero.
La solución correcta para los
acabados en un material
noble como el acero
inoxidable.*

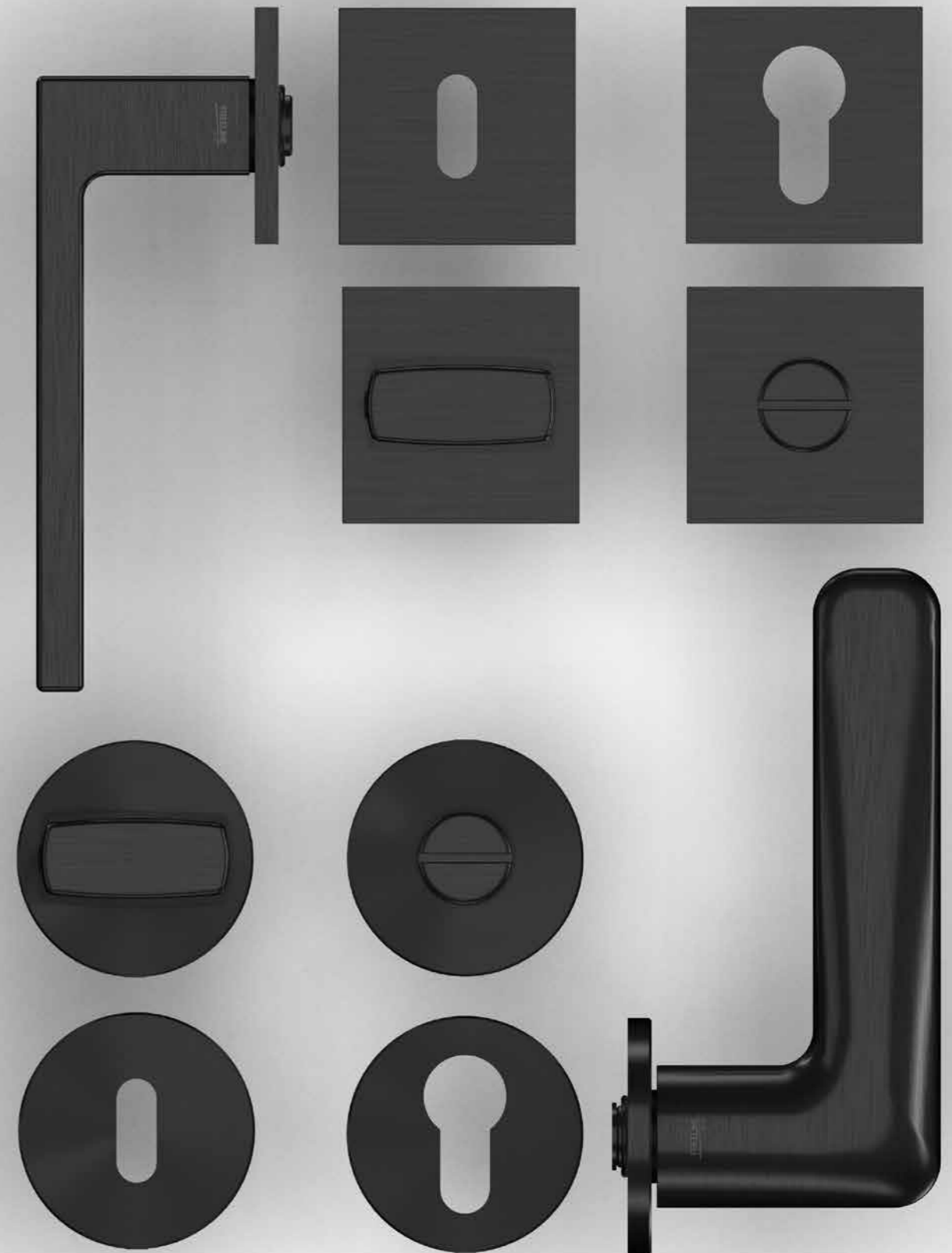



1/1 scale

Black PVD titanium

Flow

Puxador muito ergonómico com uma escala correcta para a mão. Formas arredondadas muito fluidas com um nível estético bastante equilibrado.

Very ergonomic handle with a correct scale for the hand. Very fluid rounded shapes with a very balanced aesthetic level.

Manilla muy ergonómica con una escala correcta para la mano. Formas redondeadas muy fluidas con un nivel estético muy equilibrado.

IN.00.182.RF05N.BA / Par

*Puxador de porta /
Lever handle /
Manilla de puerta*

*Roseta standard 5mm /
5mm standard rose
RF05N*

*EN 1.4301 - AISI 304
Preto Satinado /
Satin Black | Negro Satin*



1 Pr. 48 Pr.



IN.04.116.BA / Set

*Fecho de casa de banho /
Bathroom snib indicator /
Condensa de baño.*



1 Set. 6 Set.



IN.04.REC.05N.BA / Par

*Entrada de chave /
Key hole /
Bocallave para llave.*



IN.04.RPZ.05N.BA / Par

*Entrada de chave cilindro europeu /
European cylinder key hole /
Bocallave para cilindro.*



1/1 scale

Black PVD titanium

Bergen

Forma robusta com um equilíbrio entre linhas rectas e curvas perfeito. Ao tacto é um puxador muito confortável.

Robust shape with a perfect balance between straight lines and curves. To the touch it is a very comfortable handle.

Forma robusta con un equilibrio perfecto entre líneas rectas y curvas. Una manilla muy cómoda al tacto.

IN.00.184.RF05N.BA / Par

Puxador de porta /
Lever handle /
Manilla de puerta

Roseta standard 5mm /
5mm standard rose
RF05N

EN 1.4301 - AISI 304
Preto Satinado |
Satin Black | Negro Satin

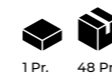

1 Pr. 48 Pr.

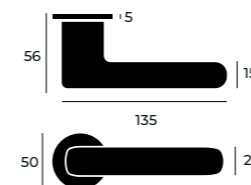

IN.04.116.BA / Set

Fecho de casa de banho /
Bathroom snib indicator /
Condena de baño.



1 Set. 6 Set.



IN.04.REC.05N.BA / Par

Entrada de chave /
Key hole /
Bocallave para llave.



IN.04.RPZ.05N.BA / Par

Entrada de chave cilindro europeu /
European cylinder key hole /
Bocallave para cilindro.



1/1 scale

Black PVD titanium

Ninety

O puxador recto com as arestas redondas, que respeitam o conforto aos ser manipulado. Uma peça intemporal.

The lever handle with rounded edges, which respect the comfort of handling. A timeless piece.

La manilla recta con bordes redondeados, que respetan la comodidad de manejo. Una pieza atemporal.

IN.00.317.QF05N.BA / Par

Puxador de porta /
Lever handle /
Manilla de puerta

Roseta standard 5mm /
5mm standard rose
QF05N

EN 1.4301 - AISI 304
Preto Satinado /
Satin Black | Negro Satin

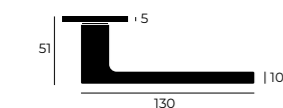

IN.04.117.BA / Set

Fecho de casa de banho /
Bathroom snib indicator /
Condena de baño.



IN.04.QEC.05N.BA / Par

Entrada de chave /
Key hole /
Bocallave para llave.



IN.04.QPZ.05N.BA / Par

Entrada de chave cilindro europeu /
European cylinder key hole /
Bocallave para cilindro.

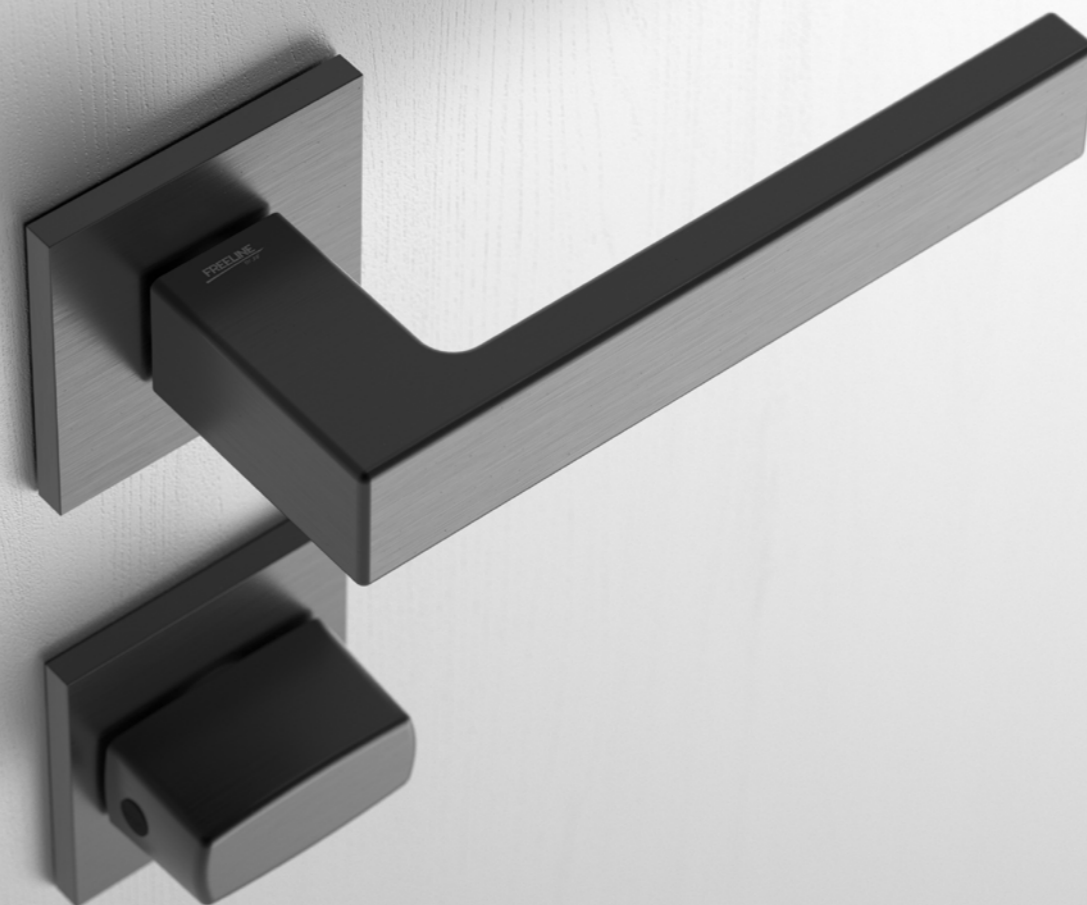

SEVENTY LINE

PT

Uma seleção de puxadores que são uma referência do design dos anos setenta. São desenhos intemporais, fabricados em tubo de aço inox com as proporções e medidas perfeitas.

EN

A selection of lever handles that are a design reference of the seventies. They are timeless designs, made of stainless steel tube with the perfect portions and measurements.

ES

Una selección de manillas de puerta que son una referencia del diseño de los años setenta. Son diseños atemporales, realizados en tubo de acero inoxidable con las proporciones y medidas perfectas.





THE MOST POWERFUL HANDLE ROSE WITH HIGH PERFORMANCE

Testados 200,000 ciclos = 22 anos a abrir a porta 25 vezes por dia |
Tested 200,000 cycles = 22 years opening the door 25 times per day |
200,000 ciclos probados = 22 años abriendo la puerta 25 veces al día.

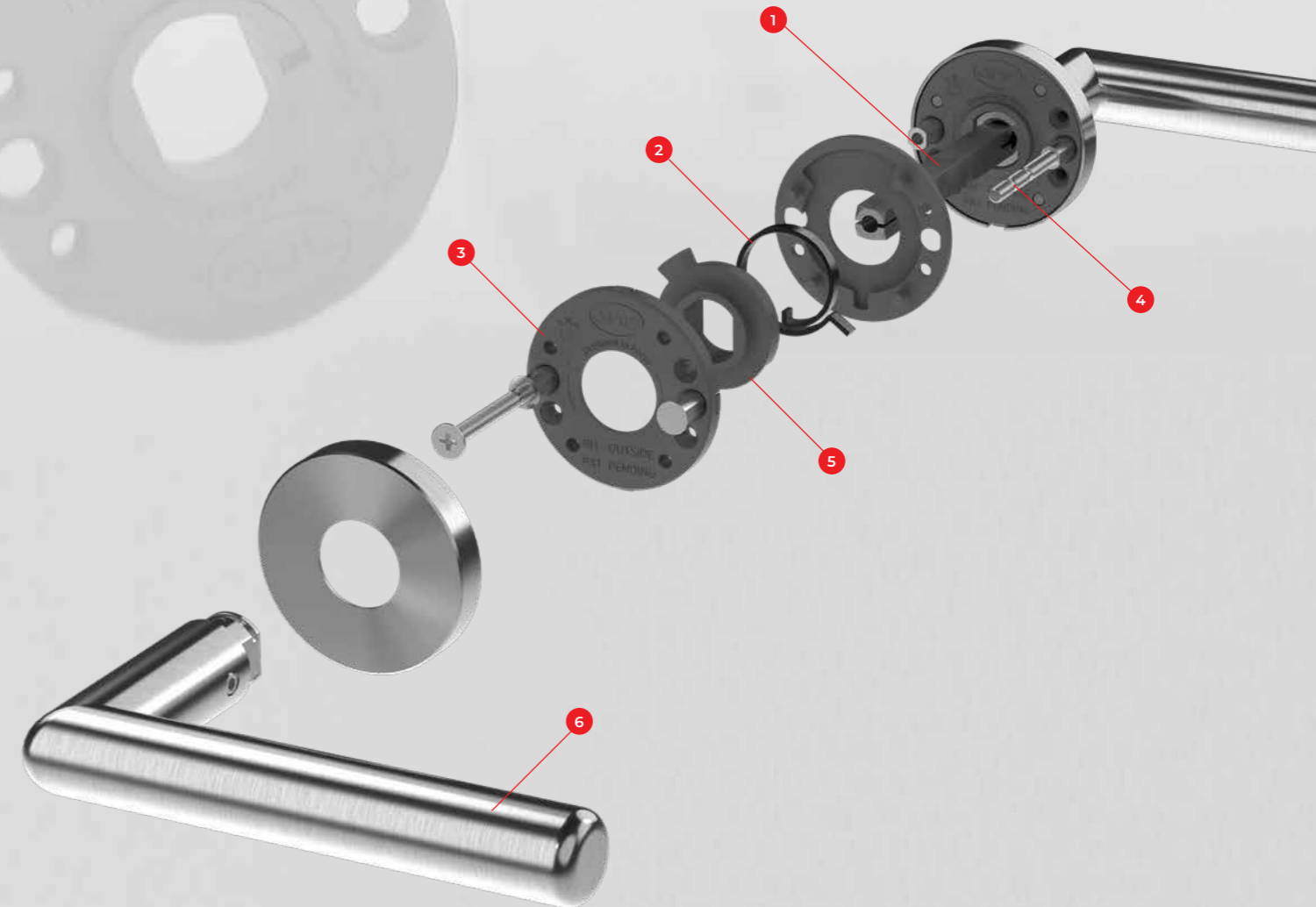

- 1 **Quadra 8x8mm com sistema fixação que garante 2500Nm de tração /**
8x8mm spindle with strong fixing system 2500Nm traction /
Cuadradillo 8x8mm con sistema de sujeción que garantiza 2500Nm de tracción.
- 2 **Mola de aço temperado em pré-carga**
Hardened steel spring one way pre-charged
Mola de acero templado pre-cargada.
- 3 **Pinos para melhorar a estabilidade da base /**
Pins to improve stability of the base /
Pitones para mejorar la estabilidad de la base.
- 4 **Parafusos M4, pré cortados para espessuras diferentes de porta /**
M4 passing screws, easy cut system to adjust to different door thickness /
Tornillos M4, pre cortados para ajustar a distintos espesores de puerta.
- 5 **Base de puxador em nylon com fibra de vidro /**
Support of the handle in nylon with fiber glass /
Base de la manilla en nylon con fibra de cristal.
- 6 **Puxadores (possível trocar o modelo)**
Interchangeable handles /
Manilla intercambiable.



Ø19
mm

Seventy

*Puxador tubular
intemporal dos anos 70.
Arestas arredondadas que lhe
conferem uma ergonomia e
identidade única.*

*Timeless tubular
handle from the 70s.
Rounded edges that gives
it a unique ergonomics and
identity.*

*Manilla tubular
atemporal de los años 70.
Bordes redondeados que
le dan ergonomía y una
identidad única.*

Ø16
mm

Seventy

*A sutileza do diâmetro 16mm
de um puxador tubular
intemporal dos anos 70.
Arestas arredondadas que lhe
conferem uma ergonomia e
identidade única.*

*The subtlety of the 16mm
diameter of timeless tubular
handle from the 70s.
Rounded edges that gives
it a unique ergonomics and
identity.*

*La sutileza del diámetro de 16
mm de una manilla tubular
atemporal de los años 70.
Bordes redondeados que
le dan ergonomía y una
identidad única.*

IN.00.180.RC08N / Par

*Puxador de porta /
Lever handle /
Manilla de puerta*

*Roseta de nylon standard 8mm /
8mm nylon standard rose
RC08N*

EN 1.4301 - AISI 304
Satinado / Satin / Satin



1 Pr. 48 Pr.

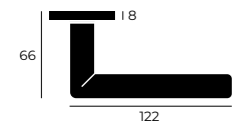

IN.04.115 / Set

*Fecho de casa de banho /
Bathroom snib indicator /
Condena de baño.*



4 Set 40 Set



IN.04.28R.P08N / Par

*Entrada de chave /
Key hole /
Bocallave para llave.*



IN.04.28R.Y08N / Par

*Entrada de chave cilindro europeu /
European cylinder key hole /
Bocallave para cilindro.*

IN.00.181.RC08N / Par

*Puxador de porta /
Lever handle /
Manilla de puerta*

*Roseta de nylon standard 8mm /
8mm nylon standard rose
RC08N*

EN 1.4301 - AISI 304
Satinado / Satin / Satin



1 Pr. 48 Pr.



IN.04.115 / Set

*Fecho de casa de banho /
Bathroom snib indicator /
Condena de baño.*



4 Set 40 Set



IN.04.28R.P08N / Par

*Entrada de chave /
Key hole /
Bocallave para llave.*



IN.04.28R.Y08N / Par

*Entrada de chave cilindro europeu /
European cylinder key hole /
Bocallave para cilindro.*



Ø19
mm

Tubular

O tubular mais conhecido no mundo dos puxadores, interpretado em diâmetro de 19mm. Fabricado com as proporções correctas.

The best known tubular in the world of knobs, interpreted in 19mm diameter. Manufactured with the correct proportions.

El tubular más conocido en el mundo de las manillas, interpretado en 19mm de diámetro. Fabricado con las proporciones correctas.

Ø16
mm

Tubular

O tubular mais conhecido no mundo dos puxadores, interpretado em diâmetro de 16mm. Fabricado com as proporções correctas.

The best known tubular in the world of knobs, interpreted in 16mm diameter. Manufactured with the correct proportions.

El tubular más conocido en el mundo de las manillas, interpretado en 16mm de diámetro. Fabricado con las proporciones correctas.

IN.00.328 / Par

Puxador de porta /
Lever handle /
Manilla de puerta

Roseta de nylon standard 8mm /
8mm nylon standard rose
RC08N

EN 1.4301 - AISI 304
Satinado / Satin / Satin



IN.04.115 / Set

Fecho de casa de banho /
Bathroom snib indicator /
Condena de baño.



IN.04.28R.P08N / Par

Entrada de chave /
Key hole /
Bocallave para llave.



IN.04.28R.Y08N / Par

Entrada de chave cilindro europeu /
European cylinder key hole /
Bocallave para cilindro.

IN.00.316.RC08N / Par

Puxador de porta /
Lever handle /
Manilla de puerta

Roseta de nylon standard 8mm /
8mm nylon standard rose
RC08N

EN 1.4301 - AISI 304
Satinado / Satin / Satin



IN.04.115 / Set

Fecho de casa de banho /
Bathroom snib indicator /
Condena de baño.



IN.04.28R.P08N / Par

Entrada de chave /
Key hole /
Bocallave para llave.



IN.04.28R.Y08N / Par

Entrada de chave cilindro europeu /
European cylinder key hole /
Bocallave para cilindro.



Ø19 mm

Ângulo

O puxador tubular a 90° de todos os tempos. Realizado com formas correctas e escala adequada.

The 90° tubular handle of all time. Made with correct forms and adequate scale.

La manilla tubular de 90° de todos los tiempos. Realizado con las formas correctas y la escala adecuada.

IN.00.330 / Par

Puxador de porta /
Lever handle /
Manilla de puerta

Roseta de nylon standard 8mm /
8mm nylon standard rose
RC08N

EN 1.4301 - AISI 304
Satinado / Satin / Satin



IN.04.115 / Set

Fecho de casa de banho /
Bathroom snib indicator /
Condena de baño.



IN.04.28R.P08N / Par

Entrada de chave /
Key hole /
Bocallave para llave.



IN.04.28R.Y08N / Par

Entrada de chave cilindro europeu /
European cylinder key hole /
Bocallave para cilindro.



1/1 scale

Ø19
mm

Black PVD titanium

Seventy

*Puxador tubular
intemporal dos anos 70.
Arestas arredondadas que lhe
conferem uma ergonomia e
identidade única.*

*Timeless tubular
handle from the 70s.
Rounded edges that gives
it a unique ergonomics and
identity.*

*Manilla tubular
atemporal de los años 70.
Bordes redondeados que
le dan ergonomía y una
identidad única.*

IN.00.180.RC08N.BA / Par

*Puxador de porta /
Lever handle /
Manilla de puerta*

*Roseta de nylon standard 8mm /
8mm nylon standard rose
RC08N*

*EN 1.4301 - AISI 304
Preto Satinado /
Satin Black | Negro Satin*

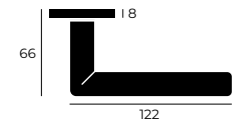

IN.04.115.BA / Set

*Fecho de casa de banho /
Bathroom snib indicator /
Condena de baño.*



IN.04.28R.P08N.TB / Par

*Entrada de chave /
Key hole /
Bocallave para llave.*



IN.04.28R.Y08N.TB / Par

*Entrada de chave cilindro europeu /
European cylinder key hole /
Bocallave para cilindro.*





Ø16
mm

Black PVD titanium

Seventy

A sutileza do diâmetro 16mm de um puxador tubular intemporal dos anos 70. Arestas arredondadas que lhe conferem uma ergonomia e identidade única.

The subtlety of the 16mm diameter of timeless tubular handle from the 70s. Rounded edges that gives it a unique ergonomics and identity.

La sutileza del diámetro de 16 mm de una manilla tubular atemporal de los años 70. Bordes redondeados que le dan ergonomía y una identidad única.

Ø16
mm

Black PVD titanium

Tubular

O tubular mais conhecido no mundo dos puxadores, interpretado em diâmetro de 16mm. Fabricado com as proporções correctas.

The best known tubular in the world of knobs, interpreted in 16mm diameter. Manufactured with the correct proportions.

El tubular más conocido en el mundo de las manillas, interpretado en 16mm de diámetro. Fabricado con las proporciones correctas.

IN.00.181.RC08N.BA / Par

Puxador de porta /
Lever handle /
Manilla de puerta

Roseta de nylon standard 8mm /
8mm nylon standard rose
RC08N

EN 1.4301 - AISI 304
Preto Satinado |
Satin Black | Negro Satin



IN.04.115.BA / Set

Fecho de casa de banho /
Bathroom snib indicator /
Condena de baño.



4 Set 40 Set



IN.04.28R.P08N.TB / Par

Entrada de chave /
Key hole /
Bocallave para llave.



IN.04.28R.Y08N.TB / Par

Entrada de chave cilindro europeu /
European cylinder key hole /
Bocallave para cilindro.

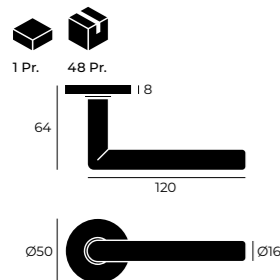

IN.00.316.RC08N.BA / Par

Puxador de porta /
Lever handle /
Manilla de puerta

Roseta de nylon standard 8mm /
8mm nylon standard rose
RC08N

EN 1.4301 - AISI 304
Preto Satinado |
Satin Black | Negro Satin



IN.04.115.BA / Set

Fecho de casa de banho /
Bathroom snib indicator /
Condena de baño.



4 Set 40 Set



IN.04.28R.P08N.TB / Par

Entrada de chave /
Key hole /
Bocallave para llave.



IN.04.28R.Y08N.TB / Par

Entrada de chave cilindro europeu /
European cylinder key hole /
Bocallave para cilindro.

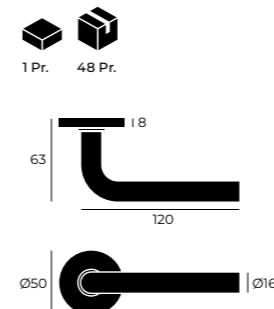



Ø19
mm

Black RAL 9005

Tubular

O tubular mais conhecido no mundo dos puxadores, interpretado em diâmetro de 19mm. Fabricado com as proporções correctas.

The best known tubular in the world of knobs, interpreted in 19mm diameter. Manufactured with the correct proportions.

El tubular más conocido en el mundo de las manillas, interpretado en 19mm de diámetro. Fabricado con las proporciones correctas.

Ø19
mm

Black RAL 9005

Ângulo

O puxador tubular a 90° de todos os tempos. Realizado com formas correctas e escala adequada.

The 90° tubular handle of all time. Made with correct forms and adequate scale.

La manilla tubular de 90° de todos los tiempos. Realizado con las formas correctas y la escala adecuada.

IN.00.328.RF05N.B / Par

Puxador de porta /
Lever handle /
Manilla de puerta

Roseta de nylon standard 5mm /
5mm nylon standard rose
RF05N

EN 1.4301 - AISI 304
Black RAL 9005



IN.04.116.B / Set

Fecho de casa de banho /
Bathroom snib indicator /
Condena de baño.



4 Set 40 Set



IN.04.REC.05N.B / Par

Entrada de chave /
Key hole /
Bocallave para llave.



IN.04.RPZ.05N.W / Par

Entrada de chave cilindro europeu /
European cylinder key hole /
Bocallave para cilindro.



1 Pr. 48 Pr.



IN.00.330.RF05N.B / Par

Puxador de porta /
Lever handle /
Manilla de puerta

Roseta de nylon standard 5mm /
5mm nylon standard rose
RF05N

EN 1.4301 - AISI 304
Black RAL 9005



IN.04.116.B / Set

Fecho de casa de banho /
Bathroom snib indicator /
Condena de baño.



4 Set 40 Set



IN.04.REC.05N.B / Par

Entrada de chave /
Key hole /
Bocallave para llave.



IN.04.RPZ.05N.W / Par

Entrada de chave cilindro europeu /
European cylinder key hole /
Bocallave para cilindro.



1 Pr. 48 Pr.

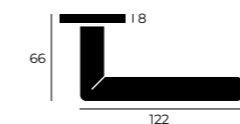



Ø19
mm

White RAL 9016

Tubular

O tubular mais conhecido no mundo dos puxadores, interpretado em diâmetro de 19mm. Fabricado com as proporções correctas.

The best known tubular in the world of knobs, interpreted in 19mm diameter. Manufactured with the correct proportions.

El tubular más conocido en el mundo de las manillas, interpretado en 19mm de diámetro. Fabricado con las proporciones correctas.

Ø19
mm

White RAL 9016

Ângulo

O puxador tubular a 90° de todos os tempos. Realizado com formas correctas e escala adequada.

The 90° tubular handle of all time. Made with correct forms and adequate scale.

La manilla tubular de 90° de todos los tiempos. Realizado con las formas correctas y la escala adecuada.

IN.00.328.RF05N.W / Par

Puxador de porta /
Lever handle /
Manilla de puerta

Roseta de nylon standard 5mm /
5mm nylon standard rose
RF05N

EN 1.4301 - AISI 304
White RAL 90016



IN.04.116.W / Set

Fecho de casa de banho /
Bathroom snib indicator /
Condena de baño.



IN.04.REC.05N.W / Par

Entrada de chave /
Key hole /
Bocallave para llave.



IN.04.RPZ.05N.W / Par

Entrada de chave cilindro europeu /
European cylinder key hole /
Bocallave para cilindro.

IN.00.330.RF05N.W / Par

Puxador de porta /
Lever handle /
Manilla de puerta

Roseta de nylon standard 5mm /
5mm nylon standard rose
RF05N

EN 1.4301 - AISI 304
White RAL 90016



IN.04.116.W / Set

Fecho de casa de banho /
Bathroom snib indicator /
Condena de baño.



IN.04.REC.05N.W / Par

Entrada de chave /
Key hole /
Bocallave para llave.



IN.04.RPZ.05N.W / Par

Entrada de chave cilindro europeu /
European cylinder key hole /
Bocallave para cilindro.



1/1 scale

Seventy 1

Desenho clássico dos anos 70, muito ergonómico, com formas fluidas e equilibradas.

Classic 70's design, very ergonomic, with fluid and balanced shapes.

Diseño clásico de los años 70 muy ergonómico, con formas fluidas y equilibradas.

IN.00.069.FR / Par

Puxador de porta /
Lever handle /
Manilla de puerta.

Roseta de nylon standard 8mm /
8mm nylon standard rose
RC08N

EN 1.4301 - AISI 304
Satinado / Satin / Satin

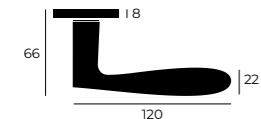

IN.04.236 / Set

Fecho de casa de banho /
Bathroom snib indicator /
Condena de baño.



IN.04.28R.P08N / Par

Entrada de chave /
Key hole /
Bocallave para llave.



IN.04.28R.Y08N / Par

Entrada de chave cilindro europeu /
European cylinder key hole /
Bocallave para cilindro.



1/1 scale

Estoril

Forma orgânica particular, para ambientes que privilegiam o conforto e a natureza, onde a relação entre ambos está em plena harmonia

Particular organic shape, for environments that privilege comfort and nature, where the relationship between both is in full harmony

Forma orgânica particular, para ambientes que privilegiam el confort y la naturaleza, donde la relación entre ambos está en plena armonía

IN.00.023.FR / Par

Puxador de porta /
Lever handle /
Manilla de puerta

Roseta de nylon standard 8mm /
8mm nylon standard rose
RC08N

EN 1.4301 - AISI 304
Satinado / Satin / Satin

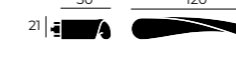

IN.04.256 / Set

Fecho de casa de banho /
Bathroom snib indicator /
Condena de baño.



IN.04.28R.P08N / Par

Entrada de chave /
Key hole /
Bocallave para llave.



IN.04.28R.Y08N / Par

Entrada de chave cilindro europeu /
European cylinder key hole /
Bocallave para cilindro.



Elle

Desenho que concilia o tubular com a ergonomia da forma oval na extremidade do puxador, esteticamente muito bem resolvido.

Design that reconciles the tubular with the ergonomics of the oval shape at the end of the handle, aesthetically very well resolved.

Diseño que concilia el tubular con la forma ovalada ergonómica del extremo la manilla, estéticamente muy bien resuelto.

IN.00.120.FR / Par

Puxador de porta /
Lever handle /
Manilla de puerta.

Roseta de nylon standard 8mm /
8mm nylon standard rose
RC08N

EN 1.4301 - AISI 304
Satinado / Satin / Satin

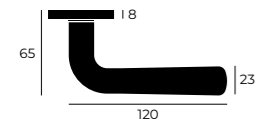

IN.04.115 / Set

Fecho de casa de banho /
Bathroom snib indicator /
Condena de baño.



IN.04.28R.P08N / Par

Entrada de chave /
Key hole /
Bocallave para llave.



IN.04.28R.Y08N / Par

Entrada de chave cilindro europeu /
European cylinder key hole /
Bocallave para cilindro.



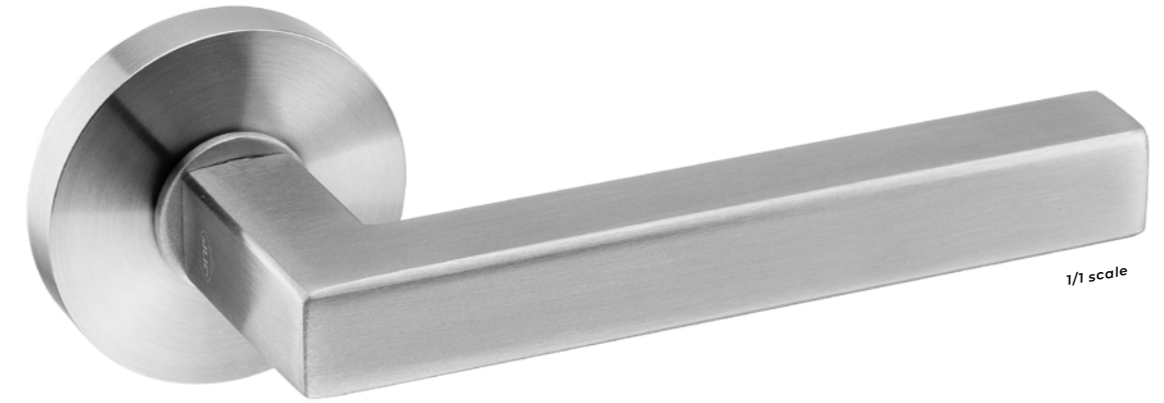
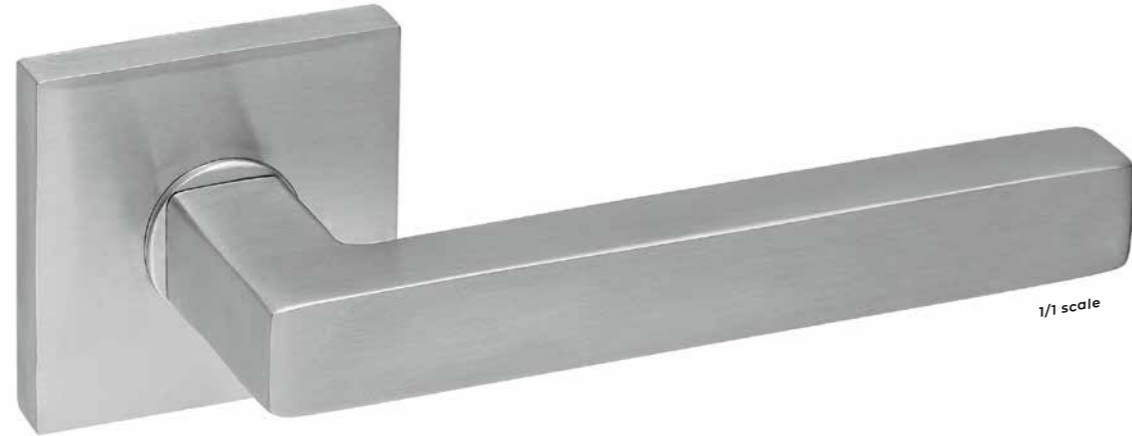

∅ 16
mm

Quadro

Um desenho intemporal que se baseia nas formas absolutamente geométricas. Em 1910 surgiram as primeiras peças com esta linguagem e a JNF recriou esta linha em 1999 e tem sido uma referência desde então. A forma quadrada nas proporções e medidas correctas.

A timeless design that is based on absolutely geometric shapes. In 1910 the first pieces with this language appeared and JNF recreated this line in 1999 and has been a reference ever since. The square shape in the right proportions and measures.

Un diseño intemporal que se basa en formas absolutamente geométricas. En 1910 aparecieron las primeras piezas con este lenguaje y el JNF recreó esta línea en 1999 y ha sido una referencia desde entonces. La forma cuadrada en las proporciones y medidas adecuadas.

∅ 16
mm

Quadro

Um desenho intemporal que se baseia nas formas absolutamente geométricas. Em 1910 surgiram as primeiras peças com esta linguagem e a JNF recriou esta linha em 1999 e tem sido uma referência desde então. A forma quadrada nas proporções e medidas correctas.

A timeless design that is based on absolutely geometric shapes. In 1910 the first pieces with this language appeared and JNF recreated this line in 1999 and has been a reference ever since. The square shape in the right proportions and measures.

Un diseño intemporal que se basa en formas absolutamente geométricas. En 1910 aparecieron las primeras piezas con este lenguaje y el JNF recreó esta línea en 1999 y ha sido una referencia desde entonces. La forma cuadrada en las proporciones y medidas adecuadas.

IN.00.106.QC08N / Par

Puxador de porta /
Lever handle /
Manilla de puerta

Roseta de nylon standard 8mm /
8mm nylon standard rose
QC08N

EN 1.4301 - AISI 304
Satinado / Satin / Satin



IN.04.246 / Set

Fecho de casa de banho /
Bathroom snib indicator /
Condena de baño.



1 Set 10 Set

IN.04.29Q.P08N / Par

Entrada de chave /
Key hole /
Bocallave para llave.



IN.04.29Q.Y08N / Par

Entrada de chave cilindro europeu /
European cylinder key hole /
Bocallave para cilindro.



1 Pr. 24 Pr.

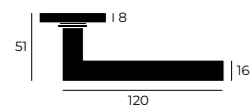

IN.00.106.RC08N / Par

Puxador de porta /
Lever handle /
Manilla de puerta

Roseta de nylon standard 8mm /
8mm nylon standard rose
RC08N

EN 1.4301 - AISI 304
Satinado / Satin / Satin



IN.04.236 / Set

Fecho de casa de banho /
Bathroom snib indicator /
Condena de baño.



1 Set 10 Set

IN.04.28R.P08N / Par

Entrada de chave /
Key hole /
Bocallave para llave.



IN.04.28R.Y08N / Par

Entrada de chave cilindro europeu /
European cylinder key hole /
Bocallave para cilindro.



1 Pr. 24 Pr.

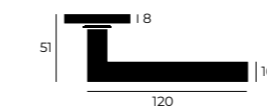



Flat

Este puxador tem um visual "Flat" que revela ao toque uma forma redonda na face interior. Peça muito ergonómica.

This handle has a "Flat" look that reveals to the touch a round shape on the inside face. Very ergonomic piece.

Esta manilla tiene un aspecto "plano" que revela al tacto una forma redonda en el interior. Pieza muy ergonómica.

IN.00.082.FR / Par

Puxador de porta /
Lever handle /
Manilla de puerta

Roseta de nylon standard 8mm /
8mm nylon standard rose
RC08N

EN 1.4301 - AISI 304
Satinado / Satin / Satin



IN.04.115 / Set

Fecho de casa de banho /
Bathroom snib indicator /
Condena de baño.



4 Set 40 Set



IN.04.28R.P08N / Par

Entrada de chave /
Key hole /
Bocallave para llave.



IN.04.28R.Y08N / Par

Entrada de chave cilindro europeu /
European cylinder key hole /
Bocallave para cilindro.



1 Pr. 24 Pr.

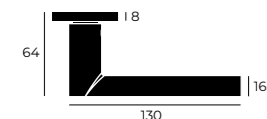

German

É um desenho que resolve a intercepção de uma barra rectangular de arestas arredondadas com a base redonda. Modelo muito equilibrado com uma presença discreta.

It is a design that resolves the interception of a round-edged rectangular bar with the round base. Very balanced model with a discreet presence.

Es un diseño que resuelve la intercepción de una barra rectangular con bordes redondeados con la base redonda. Modelo muy equilibrado con una presencia discreta.

IN.00.049.FR / Par

Puxador de porta /
Lever handle /
Manilla de puerta

Roseta de nylon standard 8mm /
8mm nylon standard rose
RC08N

EN 1.4301 - AISI 304
Satinado / Satin / Satin



IN.04.236 / Set

Fecho de casa de banho /
Bathroom snib indicator /
Condena de baño.



1 Set 10 Set



IN.04.28R.P08N / Par

Entrada de chave /
Key hole /
Bocallave para llave.



IN.04.28R.Y08N / Par

Entrada de chave cilindro europeu /
European cylinder key hole /
Bocallave para cilindro.



1 Pr. 24 Pr.

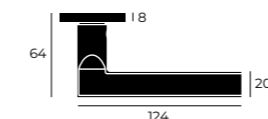



Cylinder

É um puxador que assume o cilindro da barra horizontal de 19mm, adapta-se facilmente à mão. Depois, reduz o diâmetro para 12 mm para permitir a intercepção com o elemento da roseta.

It is a handle that takes the cylinder of the 19mm horizontal bar and fits easily in the hand. It then reduces the diameter to 12mm to allow interception with the rose element.

Es una manilla que toma el cilindro de la barra horizontal de 19mm, se adapta fácilmente a la mano. A continuación, reduce el diámetro a 12 mm para permitir la intercepción con el elemento de la roseta.

IN.00.072.FR / Par

Puxador de porta /
Lever handle /
Manilla de puerta

Roseta de nylon standard 8mm /
8mm nylon standard rose
RC08N

EN 1.4301 - AISI 304
Satinado / Satin / Satin



1 Pr. 24 Pr.

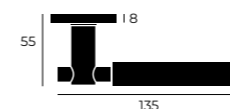

IN.04.236.06 / Set

Fecho de casa de banho /
Bathroom snib indicator /
Condena de baño.



1 Set 10 Set

IN.04.28R.P08N / Par

Entrada de chave /
Key hole /
Bocallave para llave.



IN.04.28R.Y08N / Par

Entrada de chave cilindro europeu /
European cylinder key hole /
Bocallave para cilindro.



Opo

É um modelo clássico do Porto, a expressão minimalista da intercepção de uma barra de 10mm com uma de 19mm. As proporções são correctas e os detalhes das arestas, irrepreensíveis.

It is an Oporto's classic model, the minimalist expression of the interception of a 10mm bar with a 19mm one. The proportions are correct and the edge details, flawless.

Es un modelo clásico de Oporto, la expresión minimalista de la intercepción de una barra de 10mm con una de 19mm. Las proporciones son correctas y los detalles de los bordes, irreprochables.



Thirty

Uma solução surpreendente com a junção de uma barra inclinada a 30° que retoma a horizontalidade logo depois, facilitando a abertura da fechadura.

A surprising solution with the addition of a bar inclined at 30° that resumes horizontality soon after, making it easier to open the lock.

Una solución sorprendente con la incorporación de una barra inclinada a 30° que vuelve a la posición horizontal inmediatamente después, facilitando la apertura de la cerradura.

IN.00.050.FR / Par

Puxador de porta /
Lever handle /
Manilla de puerta

Roseta de nylon standard 8mm /
8mm nylon standard rose
RC08N

EN 1.4301 - AISI 304
Satinado / Satin / Satin



IN.04.236.06 / Set

Fecho de casa de banho /
Bathroom snib indicator /
Condena de baño.



IN.04.28R.P08N / Par

Entrada de chave /
Key hole /
Bocallave para llave.



IN.04.28R.Y08N / Par

Entrada de chave cilindro europeu /
European cylinder key hole /
Bocallave para cilindro.

IN.00.054.FR / Par

Puxador de porta /
Lever handle /
Manilla de puerta

Roseta de nylon standard 8mm /
8mm nylon standard rose
RC08N

EN 1.4301 - AISI 304
Satinado / Satin / Satin



IN.04.236.06 / Set

Fecho de casa de banho /
Bathroom snib indicator /
Condena de baño.



IN.04.28R.P08N / Par

Entrada de chave /
Key hole /
Bocallave para llave.



IN.04.28R.Y08N / Par

Entrada de chave cilindro europeu /
European cylinder key hole /
Bocallave para cilindro.



1/1 scale



Round shape

A forma tubular
com a forma
da mão.

The tubular shape
with the shape of
the hand.

La forma tubular
con la forma de
la mano.

IN.00.046.FR / Par

Puxador de porta /
Lever handle /
Manilla de puerta.

Roseta de nylon standard 8mm /
8mm nylon standard rose
RC08N

EN 1.4301 - AISI 304
Satinado / Satin / Satin



IN.04.115 / Set

Fecho de casa de banho /
Bathroom snib indicator /
Condena de baño.



4 Set 40 Set



IN.04.28R.P08N / Par

Entrada de chave /
Key hole /
Bocallave para llave.



IN.04.28R.Y08N / Par

Entrada de chave cilindro europeu /
European cylinder key hole /
Bocallave para cilindro.

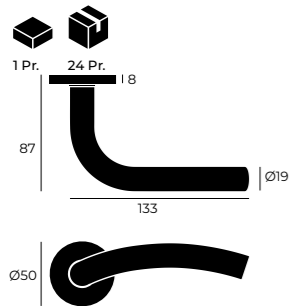



Bisel

É uma variação do puxador Ângulo, onde a extremidade foi cortada a 45°.

It is a variation of the Ângulo handle, where the end has been cut at 45°.

Se trata de una variación del mango de Ângulo, en la que el extremo se ha cortado a 45°.



Tool

Puxador robusto para decorações especiais. Forma bastante ergonómica e vanguardista.

Robust handle for special decorations. Very ergonomic and avant-garde shape.

Manilla robusta para decoraciones especiales. Forma muy ergonómica y vanguardista.

IN.00.035.FR / Par

Puxador de porta /
Lever handle /
Manilla de puerta.

Roseta de nylon standard 8mm /
8mm nylon standard rose
RC08N

EN 1.4301 - AISI 304
Satinado / Satin / Satin

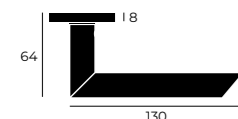

IN.04.236 / Set

Fecho de casa de banho /
Bathroom snib indicator /
Condena de baño.



IN.04.28R.P08N / Par

Entrada de chave /
Key hole /
Bocallave para llave.



IN.04.28R.Y08N / Par

Entrada de chave cilindro europeu /
European cylinder key hole /
Bocallave para cilindro.

IN.00.068.FR / Par

Puxador de porta /
Lever handle /
Manilla de puerta.

Roseta de nylon standard 8mm /
8mm nylon standard rose
RC08N

EN 1.4301 - AISI 304
Satinado / Satin / Satin

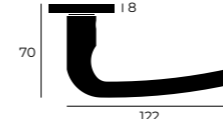

IN.04.115 / Set

Fecho de casa de banho /
Bathroom snib indicator /
Condena de baño.



IN.04.28R.P08N / Par

Entrada de chave /
Key hole /
Bocallave para llave.



IN.04.28R.Y08N / Par

Entrada de chave cilindro europeu /
European cylinder key hole /
Bocallave para cilindro.

NEW DECOR LINE RAW AGED

PT É uma gama de puxadores com acabamento de superfície, que se integra nas decorações "vintage", o Raw que é um aço envelhecido: o RAW Gold (ouro velho), o Raw Copper (cobre patina) e o Raw Black (preto envelhecido).

EN It is a range of door handles with a surface finish, which is integrated in the "vintage" decorations, Raw which is an aged steel: RAW Gold (old gold), Raw Copper (patin copper) and Raw Black (aged black).

ES Se trata de una gama de manillas de puerta con un acabado superficial que encaja con las decoraciones "vintage", Raw que es acero envejecido: RAW Gold (oro viejo), Raw Copper (cobre patina) y Raw Black (negro envejecido).

RAW Aged Aço Envelhecido





19
diam.

RAW Aged
Aço Envelhecido
Tubular

O tubular mais conhecido no mundo dos puxadores, interpretado em diâmetro de 19mm. Fabricado com as proporções correctas.

The best known tubular in the world of handles, interpreted in 19mm diameter. Manufactured with the correct proportions.

El tubular más conocido en el mundo de las manillas, interpretado en 19mm de diámetro. Fabricado con las proporciones correctas.

IN.00.028.RAW / Par

Puxador de porta /
Lever handle /
Manilla de puerta

Roseta de nylon standard 8mm /
8mm nylon standard rose
RC08N

EN 1.4301 - AISI 304
Raw Aged



IN.04.101.RAW / Set

Fecho de casa de banho /
Bathroom snib indicator /
Condena de baño.



IN.04.28R.P08N.RAW / Par

Entrada de chave /
Key hole /
Bocallave para llave.



IN.04.28R.Y08N.RAW / Par

Entrada de chave cilindro europeu /
European cylinder key hole /
Bocallave para cilindro.

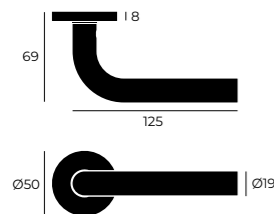

19
diam.

RAW Aged
Aço Envelhecido
Angulo

O puxador tubular a 90° de todos os tempos. Realizado com formas correctas e escala adequada.

The 90° tubular handle of all time. Made with correct forms and adequate scale.

La manilla tubular de 90° de todos los tiempos. Realizado con las formas correctas y la escala adecuada.

IN.00.030.RAW / Par

Puxador de porta /
Lever handle /
Manilla de puerta

Roseta de nylon standard 8mm /
8mm nylon standard rose
RC08N

EN 1.4301 - AISI 304
Raw Aged



IN.04.101.RAW / Set

Fecho de casa de banho /
Bathroom snib indicator /
Condena de baño.



IN.04.28R.P08N.RAW / Par

Entrada de chave /
Key hole /
Bocallave para llave.



IN.04.28R.Y08N.RAW / Par

Entrada de chave cilindro europeu /
European cylinder key hole /
Bocallave para cilindro.

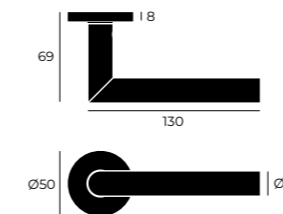

RAW Aged

Aço Envelhecido

É uma gama de ferragens com acabamento de superfície, que se integra nas decorações "vintage", o Raw que é um aço envelhecido.

It is a hardware range with a surface finish, which is integrated in the "vintage" decorations, Raw which is an aged steel.

Se trata de una gama de herrajes con un acabado superficial que encaja con las decoraciones "vintage", Raw que es acero envejecido

IN.00.090.RAW / Un.

Puxador fixo /
Fixed door knob /
Pomo de puerta fijo.

EN 1.4301 - AISI 304
Raw Aged

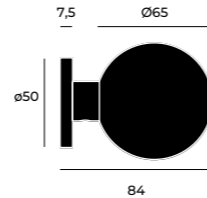

IN.16.225.40.RAW / Un. IN.16.225.50.RAW / Un. IN.16.225.70.RAW / Un. IN.16.225.110.RAW / Un.

Concha de embutir /
Flush handle / Cazoleta.

EN 1.4301 - AISI 304
Raw Aged

REF.	A	B	C	D
IN.16.225.40.RAW	40	35	10	26
IN.16.225.50.RAW	50	40	10	32
IN.16.225.70.RAW	70	60	14	49
IN.16.225.110.RAW	110	102	14	86

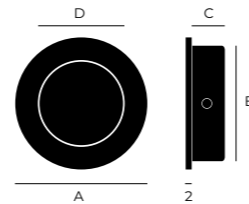

IN.16.225.110.RAW
Raw Aged
Ø110 mm

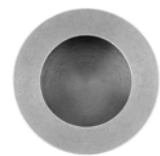

IN.16.225.40.RAW
Raw Aged
Ø40 mm

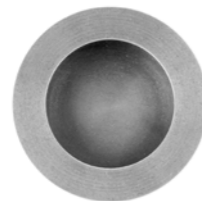

IN.16.225.50.RAW
Raw Aged
Ø50 mm



IN.16.225.70.RAW
Raw Aged
Ø70 mm



IN.16.416.RAW / Un.

Concha de embutir /
Flush handle / Cazoleta.
300 x 55 x 19 mm

EN 1.4301 - AISI 304
Raw Aged



IN.16.410.RAW / Un.

Concha de embutir /
Flush handle / Cazoleta.
135 x 70 x 19 mm

EN 1.4301 - AISI 304
Raw Aged



IN.16.412.RAW / Un.

Concha de embutir /
Flush handle / Cazoleta.
135 x 55 x 19 mm

EN 1.4301 - AISI 304
Raw Aged

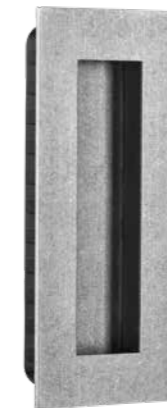

IN.16.414.RAW / Un.

Concha de embutir /
Flush handle / Cazoleta.
60 x 60 x 19 mm

EN 1.4301 - AISI 304
Raw Aged



IN.13.121.20.RAW / Un.

Batente de porta /
Door stopper /
Tope de puerta
Ø20 x 20mm

EN 1.4301 - AISI 304
Raw Aged



IN.13.121.30.RAW / Un.

Batente de porta /
Door stopper /
Tope de puerta
Ø30 x 40 mm

EN 1.4301 - AISI 304
Raw Aged



RAW GOLD Aged

Ouro velho





Ø19
mm

RAW GOLD Aged

Ouro velho

Tubular

O tubular mais conhecido no mundo dos puxadores, interpretado em diâmetro de 19mm. Fabricado com as proporções correctas.

The best known tubular in the world of handles, interpreted in 19mm diameter. Manufactured with the correct proportions.

El tubular más conocido en el mundo de las manillas, interpretado en 19mm de diámetro. Fabricado con las proporciones correctas.

IN.00.028.RG / Par

Puxador de porta /
Lever handle /
Manilla de puerta

Roseta de nylon standard 8mm /
8mm nylon standard rose
RC08N

EN 1.4301 - AISI 304
Raw Gold aged



IN.04.101.RG / Set

Fecho de casa de banho /
Bathroom snib indicator /
Condena de baño.



IN.04.28R.P08N.RG / Par

Entrada de chave /
Key hole /
Bocallave para llave.



IN.04.28R.Y08N.RG / Par

Entrada de chave cilindro europeu /
European cylinder key hole /
Bocallave para cilindro.

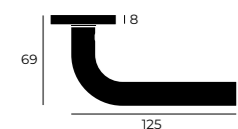

Ø19
mm

RAW GOLD Aged

Ouro velho

Angulo

O puxador tubular a 90° de todos os tempos. Realizado com formas correctas e escala adequada.

The 90° tubular handle of all time. Made with correct forms and adequate scale.

La manilla tubular de 90° de todos los tiempos. Realizado con las formas correctas y la escala adecuada.

IN.00.030.RG / Par

Puxador de porta /
Lever handle /
Manilla de puerta.

Roseta de nylon standard 8mm /
8mm nylon standard rose
RC08N

EN 1.4301 - AISI 304
Raw Gold aged



IN.04.101.RG / Set

Fecho de casa de banho /
Bathroom snib indicator /
Condena de baño.



IN.04.28R.P08N.RG / Par

Entrada de chave /
Key hole /
Bocallave para llave.



IN.04.28R.Y08N.RG / Par

Entrada de chave cilindro europeu /
European cylinder key hole /
Bocallave para cilindro.

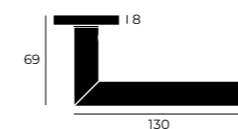

RAW GOLD Aged

Ouro velho

É uma gama de ferragens com acabamento de superfície, que se integra nas decorações "vintage", o Raw Gold Aged (ouro velho) que é um aço envelhecido.

It is a hardware range with a surface finish, which is integrated in the "vintage" decorations, Raw Gold Aged (old gold) which is an aged steel.

Se trata de una gama de herrajes con un acabado superficial que encaja con las decoraciones "vintage", Raw (oro viejo) que es acero envejecido.

IN.00.090.RG / Un.

Puxador fixo /
Fixed door knob /
Pomo de puerta fijo.

EN 1.4301 - AISI 304
Raw Gold aged

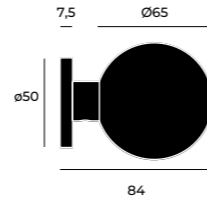

IN.16.225.40.RG / Un. IN.16.225.50.RG / Un. IN.16.225.70.RG / Un. IN.16.225.110.RG / Un.

Concha de embutir /
Flush handle / Cazoleta.

EN 1.4301 - AISI 304
Raw Gold aged

REF.	A	B	C	D
IN.16.225.40.RG	40	35	10	26
IN.16.225.50.RG	50	40	10	32
IN.16.225.70.RG	70	60	14	49
IN.16.225.110.RG	110	102	14	86



IN.16.225.110.RG
Raw Gold aged
Ø110 mm



IN.16.225.50.RG
Raw Gold aged
Ø50 mm



IN.16.225.70.RG
Raw Gold aged
Ø70 mm

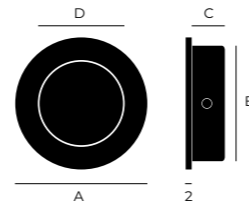

IN.16.416.RG / Un.

Concha de embutir /
Flush handle / Cazoleta.
300 x 55 x 19 mm

EN 1.4301 - AISI 304
Raw Gold aged

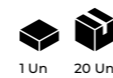

IN.16.410.RG / Un.

Concha de embutir /
Flush handle / Cazoleta.
135 x 70 x 19 mm

EN 1.4301 - AISI 304
Raw Gold aged



IN.16.412.RG / Un.

Concha de embutir /
Flush handle / Cazoleta.
135 x 55 x 19 mm

EN 1.4301 - AISI 304
Raw Gold aged



IN.16.414.RG / Un.

Concha de embutir /
Flush handle / Cazoleta.
60 x 60 x 19 mm

EN 1.4301 - AISI 304
Raw Gold aged



IN.13.121.20.RG / Un.

Batente de porta /
Door stopper /
Tope de puerta.
Ø20 x 20mm

EN 1.4301 - AISI 304
Raw Gold aged



IN.13.121.30.RG / Un.

Batente de porta /
Door stopper /
Tope de puerta.
Ø30 x 40mm

EN 1.4301 - AISI 304
Raw Gold aged



RAW COPPER Aged

Cobre patina





Ø19
mm

RAW COPPER Aged

Cobre patina
Tubular

O tubular mais conhecido no mundo dos puxadores, interpretado em diâmetro de 19mm. Fabricado com as proporções correctas.

The best known tubular in the world of lever handles, interpreted in 19mm diameter. Manufactured with the correct proportions.

El tubular más conocido en el mundo de las manillas, interpretado en 19mm de diámetro. Fabricado con las proporciones correctas.

IN.00.028.RCO / Par

Puxador de porta /
Lever handle /
Manilla de puerta

Roseta de nylon standard 8mm |
8mm nylon standard rose
RC08N

EN 1.4301 - AISI 304
Raw Copper aged



IN.04.101.RCO / Set

Fecho de casa de banho /
Bathroom snib indicator /
Condena de baño.



IN.04.28R.P08N.RCO / Par

Entrada de chave /
Key hole /
Bocallave para llave.



IN.04.28R.Y08N.RCO / Par

Entrada de chave cilindro europeu /
European cylinder key hole /
Bocallave para cilindro.

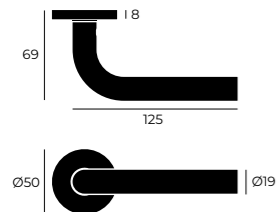

Ø19
mm

RAW COPPER Aged

Cobre patina
Angulo

O puxador tubular a 90° de todos os tempos. Realizado com formas correctas e escala adequada.

The 90° tubular handle of all time. Made with correct forms and adequate scale.

La manilla tubular de 90° de todos los tiempos. Realizado con las formas correctas y la escala adecuada.

IN.00.030.RCO / Par

Puxador de porta |
Lever handle |
Manilla de puerta

Roseta de nylon standard 8mm |
8mm nylon standard rose
RC08N

EN 1.4301 - AISI 304
Raw Copper aged



IN.04.101.RCO / Set

Fecho de casa de banho /
Bathroom snib indicator /
Condena de baño.



IN.04.28R.P08N.RCO / Par

Entrada de chave /
Key hole /
Bocallave para llave.



IN.04.28R.Y08N.RCO / Par

Entrada de chave cilindro europeu /
European cylinder key hole /
Bocallave para cilindro.

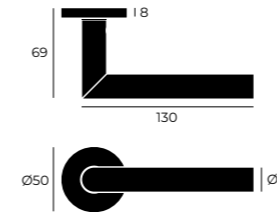

RAW COPPER Aged

Cobre patina

É uma gama de ferragens com acabamento de superfície, que se integra nas decorações "vintage", o Raw Copper Aged (cobre patina) que é um aço envelhecido.

It is a hardware range with a surface finish, which is integrated in the "vintage" decorations, Raw Copper Aged (patin copper) which is an aged steel.

Se trata de una gama de herrajes con un acabado superficial que encaja con las decoraciones "vintage", Raw Copper Aged (cobre patina) que es acero envejecido.

IN.00.090.RCO / Un.

Puxador fixo |
Fixed door knob | Pomo de puerta fijo.

EN 1.4301 - AISI 304
Raw Copper aged

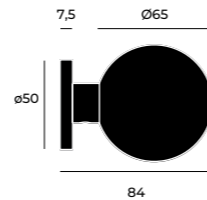

IN.16.225.40.RCO / Un. IN.16.225.50.RCO / Un. IN.16.225.70.RCO / Un. IN.16.225.110.RCO / Un.

Concha de embutir |
Flush handle | Cazoleta

EN 1.4301 - AISI 304
Raw Copper aged

REF.	A	B	C	D
IN.16.225.40.RCO	40	35	10	26
IN.16.225.50.RCO	50	40	10	32
IN.16.225.70.RCO	70	60	14	49
IN.16.225.110.RCO	110	102	14	86



Raw Copper aged
Ø110 mm



IN.16.225.40.RCO
Raw Copper aged
Ø40 mm



Raw Copper aged
Ø50 mm



IN.16.225.70.RCO
Raw Copper aged
Ø70 mm

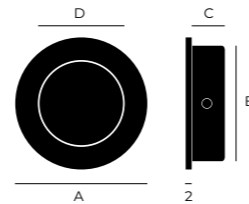

IN.16.416.RCO / Un.

Concha de embutir |
Flush handle | Cazoleta
300 x 55 x 19 mm

EN 1.4301 - AISI 304
Raw Copper aged



IN.16.410.RCO / Un.

Concha de embutir |
Flush handle | Cazoleta
135 x 70 x 19 mm

EN 1.4301 - AISI 304
Raw Copper aged



IN.16.412.RCO / Un.

Concha de embutir |
Flush handle | Cazoleta
135 x 55 x 19 mm

EN 1.4301 - AISI 304
Raw Copper aged



IN.16.414.RCO / Un.

Concha de embutir |
Flush handle | Cazoleta
60 x 60 x 19 mm

EN 1.4301 - AISI 304
Raw Copper aged



IN.13.121.20.RCO / Un.

Batente de porta |
Door stopper |
Tope de puerta
Ø20 x 20mm

EN 1.4301 - AISI 304
Raw Copper aged



IN.13.121.30.RCO / Un.

Batente de porta |
Door stopper |
Tope de puerta
Ø30 x 40mm

EN 1.4301 - AISI 304
Raw Copper aged





DIN 179

Window handle

AL2919DK / Set

Puxador com mecanismo de janela DK com interior em nylon de 4 posições
Lever handle with DK window mechanism with 4 position nylon interior /
Manilla con mecanismo de ventana DK con interior de nylon de 4 posiciones.

EN 1.4301 - AISI 304
Satinado | Satin

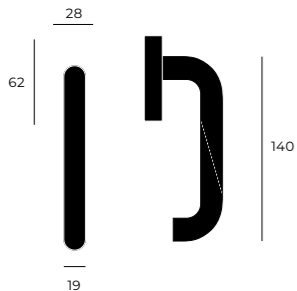

TURNING AND FIXED KNOBS FOR DOORS

**PUXADOR DE PORTA
FIXOS E ROTATIVOS |**
POMOS DE PUERTA FIJO
Y GIRATORIAS



Ball Turning Knob

IN.00.090.G / Par

Puxador rotativo /
Turning knob /
Pomo giratório.

Roseta standard de nylon 8mm /
8mm nylon standard rose
RC08N

EN 1.4301 - AISI 304
Satinado | Satin

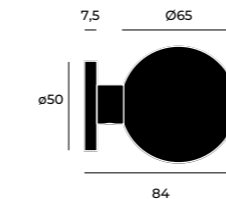

Disc Turning Knob

IN.00.092.G / Par

Puxador rotativo /
Turning knob /
Pomo giratório.

Roseta standard de nylon 8mm /
8mm nylon standard rose
RC08N

EN 1.4301 - AISI 304
Satinado | Satin

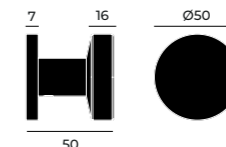



Quadro

Turning Knob

IN.00.110 / Par

Puxador rotativo /
Turning knob /
Pomo giratório.

Roseta de nylon standard 8mm /
8mm nylon standard rose
QC08N

EN 1.4301 - AISI 304
Satinado | Satin



Cylinder

Fixed Knob

IN.00.102.R / Un.

Puxador de porta fixo /
Fixed door knob /
Pomo fijo de puerta.

EN 1.4301 - AISI 304
Satinado | Satin

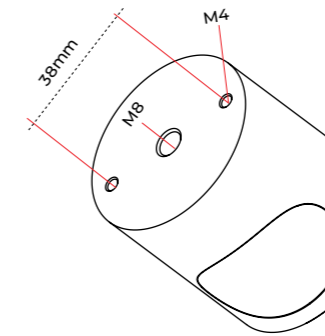

Disc

Fixed Knob

IN.00.092 / Un.

Puxador de porta fixo /
Fixed door knob /
Pomo fijo de puerta

EN 1.4301 - AISI 304
Satinado | Satin

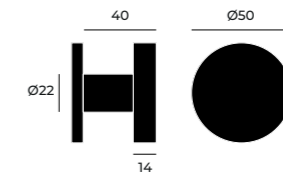



Quadro

Fixed Knob

IN.00.113 / Un.

Puxador de porta fixo |
Fixed door knob |
Pomo fijo de puerta.

EN 1.4301 - AISI 304
Satinado | Satin

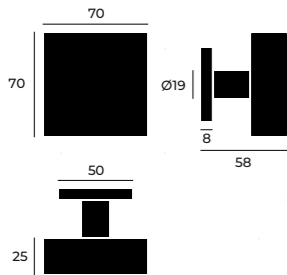

Quadro

Fixed Knob

IN.00.111 / Un.

Puxador de porta fixo |
Fixed door knob |
Pomo fijo de puerta.

EN 1.4301 - AISI 304
Satinado | Satin



Quadro

Fixed Knob

IN.00.405 / Par

Puxador fixo |
Fixed knob |
Pomo fijo.

EN 1.4301 - AISI 304
Satinado | Satin

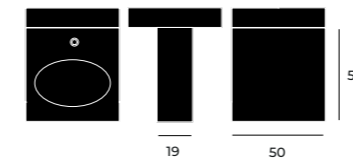
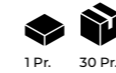

SNIB INDICATORS

FECHO WC
CONDENA DE BAÑO

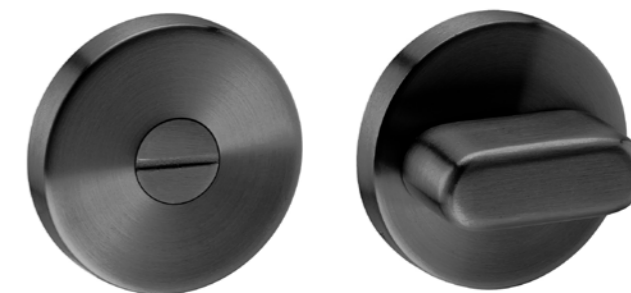

Comfort Snib indicator

IN.04.115 / Set

Fecho wc com ranhura para moeda sem indicador, base em nylon e fixações ocultas /

Bathroom snib indicator with coin slot without color indication, nylon base and concealed fixings /

Condena de baño con fenda para moneda sin indicador, base en nylon e fijaciones ocultas.

EN 1.4301 - AISI 304
Satinado | Satin

Quadra |
Spindle |
Cuadradillo
6X6

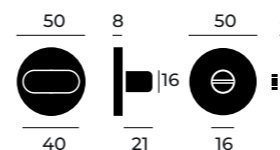

Comfort black Snib indicator

Black PVD titanium

IN.04.115.BA / Set

Fecho wc com ranhura para moeda sem indicador, base em nylon e fixações ocultas /

Bathroom snib indicator with coin slot without color indication, nylon base and concealed fixings /

Condena de baño con fenda para moneda sin indicador, base en nylon e fijaciones ocultas.

EN 1.4301 - AISI 304
Preto Satinado |
Satin Black | Negro Satin

Quadra |
Spindle |
Cuadradillo
6X6

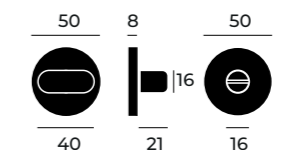



Ergo Snib indicator

IN.04.256 / Set

Fecho wc com ranhura para moeda sem indicador, base em nylon e fixações ocultas /

Bathroom snib indicator with coin slot without color indication, nylon base and concealed fixings /

Condena de baño con fenda para moneda sin indicador, base en nylon e fijaciones ocultas.

EN 1.4301 - AISI 304
Satinado | Satin

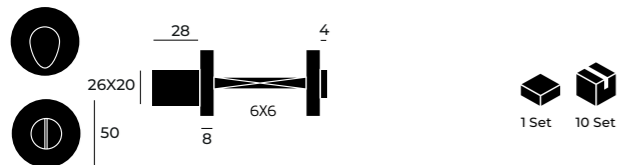

Ergo Snib indicator

IN.04.254 / Set

Fecho wc com ranhura para moeda com indicador, base em nylon e fixações ocultas /

Bathroom snib indicator with coin slot with color indication, nylon base and concealed fixings /

Condena de baño con fenda para moneda con indicador, base en nylon e fijaciones ocultas.

EN 1.4301 - AISI 304
Satinado | Satin

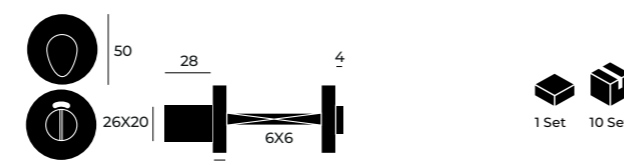

Não compatível com IN.20.AWC |
Not compatible with IN.20.AWC |
No es compatible con IN.20.AWC

Classic Snib indicator

IN.04.236 / Set

Fecho wc com ranhura para moeda sem indicador, base em nylon e fixações ocultas /

Bathroom snib indicator with coin slot without color indication, nylon base and concealed fixings /

Condena de baño con fenda para moneda sin indicador, base en nylon e fijaciones ocultas.

EN 1.4301 - AISI 304
Satinado | Satin

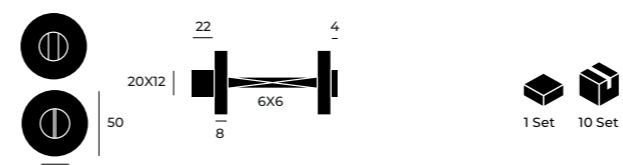

Classic Snib indicator

IN.04.234 / Set

Fecho wc com ranhura para moeda com indicador, base em nylon e fixações ocultas /

Bathroom snib indicator with coin slot with color indication, nylon base and concealed fixings /

Condena de baño con fenda para moneda con indicador, base en nylon e fijaciones ocultas.

EN 1.4301 - AISI 304
Satinado | Satin

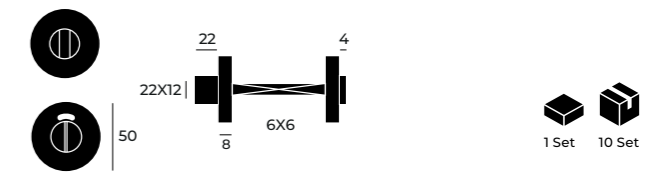

Não compatível com IN.20.AWC |
Not compatible with IN.20.AWC |
No es compatible con IN.20.AWC



Opo Snib indicator

IN.04.236.06 / Set

Fecho wc com ranhura para moeda sem indicador, base em nylon e fixações ocultas /

Bathroom snib indicator with coin slot without color indication, nylon base and concealed fixings /

Condena de baño con fenda para moneda sin indicador, base en nylon e fijaciones ocultas.

EN 1.4301 - AISI 304
Satinado | Satin

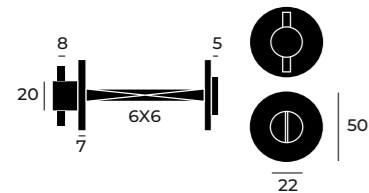

Opo Snib indicator

IN.04.239.06 / Set

Fecho wc com ranhura para moeda com indicador, base em nylon e fixações ocultas /

Bathroom snib indicator with coin slot with color indication, nylon base and concealed fixings /

Condena de baño con fenda para moneda con indicador, base en nylon e fijaciones ocultas.

EN 1.4301 - AISI 304
Satinado | Satin

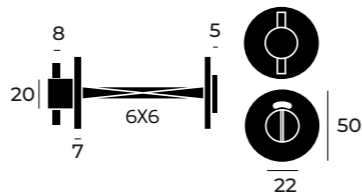

*Não compatível com IN.20.AWC /
Not compatible with IN.20.AWC /
No es compatible con IN.20.AWC*

SECURITY HARDWARE

PROTECTORES
DE CILINDRO
HARDWARE DE
SEGURIDAD



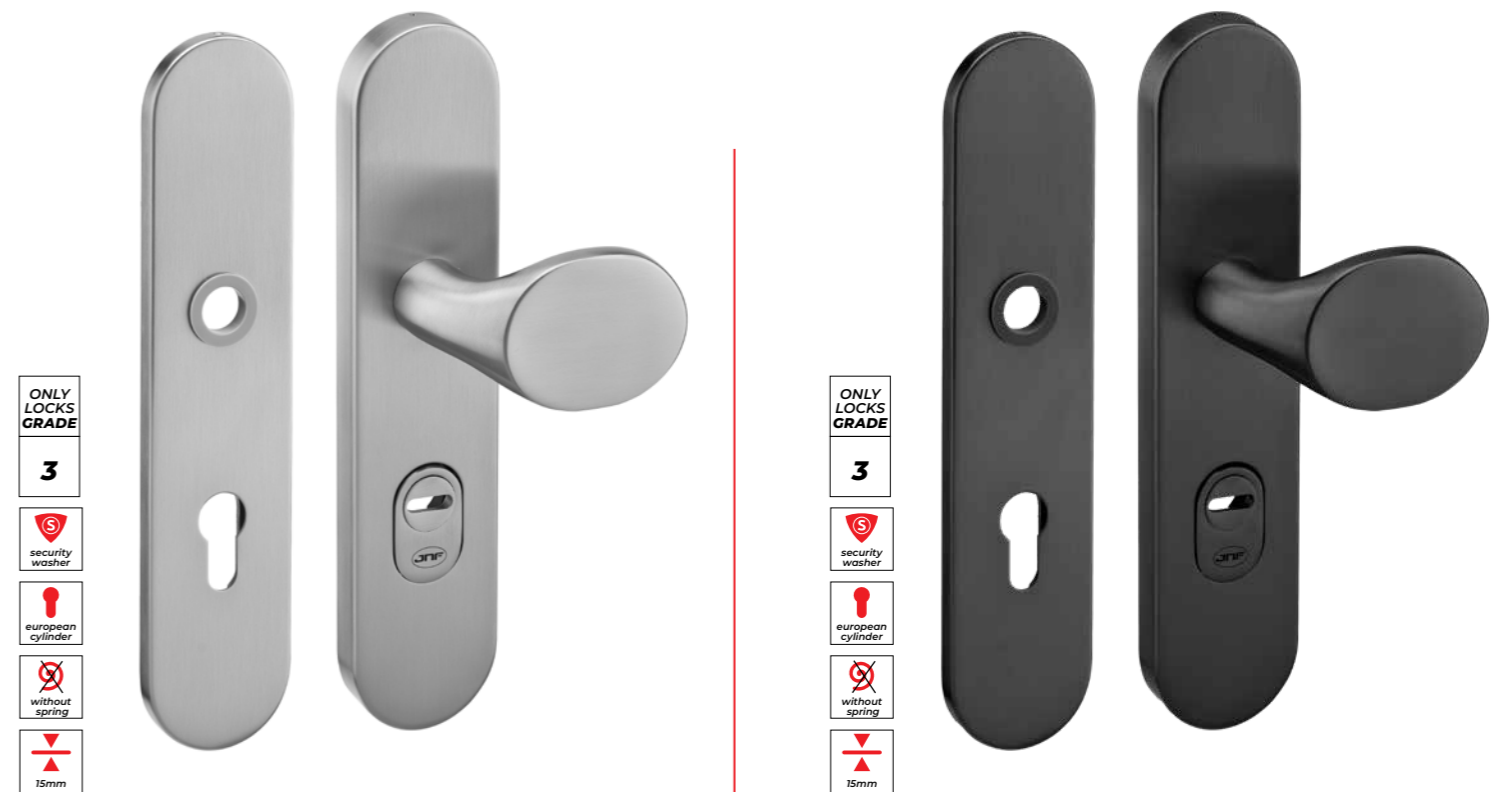
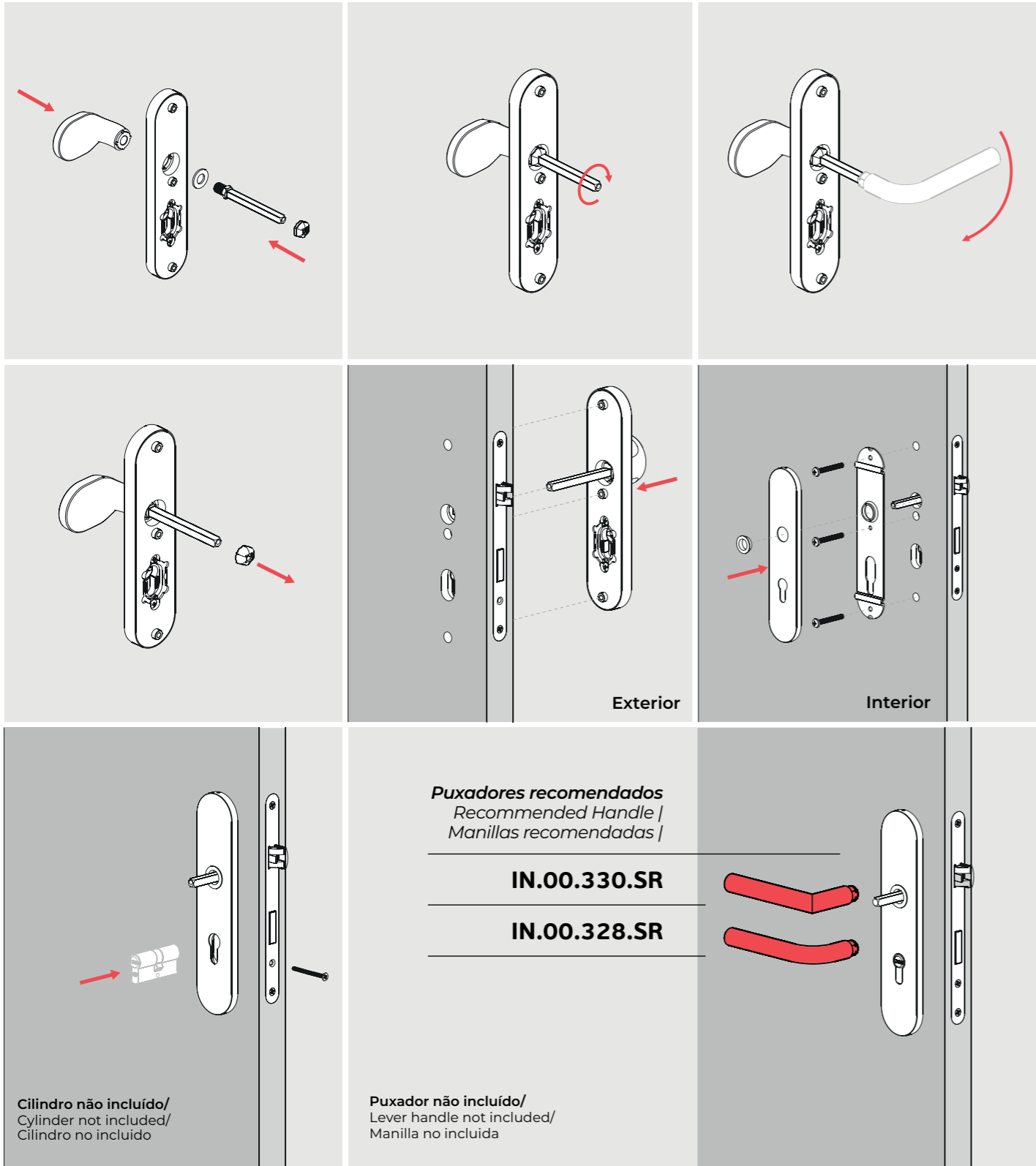

Ergo Security plate

IN.03.050.72 / Set
IN.03.050.85 / Set
IN.03.050.92 / Set

Placa de segurança. Puxador fixo exterior incluído e rotativo no interior não incluído (disponível qualquer modelo do catálogo) /

Safety plate. Fixed handle outside included, rotative inside not included (can be chosen any available model from the catalogue) /

Placa de seguridad. Pomo fijo en exterior incluído y exterior rotativo no incluído (disponible cualquier modelo del catálogo).

EN 1.4301 - AISI 304
Satinado | Satin



1 Set 10 Set

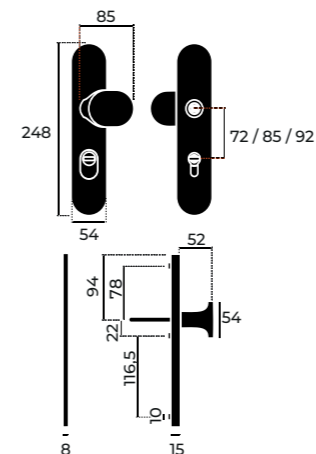

Ergo black Security plate

IN.03.050.72.TB / Set
IN.03.050.85.TB / Set
IN.03.050.92.TB / Set

Placa de segurança. Puxador fixo exterior incluído e rotativo no interior não incluído (disponível qualquer modelo do catálogo) /

Safety plate. Fixed handle outside included, rotative inside not included (can be chosen any available model from the catalogue) /

Placa de seguridad. Pomo fijo en exterior incluído y exterior rotativo no incluído (disponible cualquier modelo del catálogo).

EN 1.4301 - AISI 304
Satinado | Satin



1 Set 10 Set

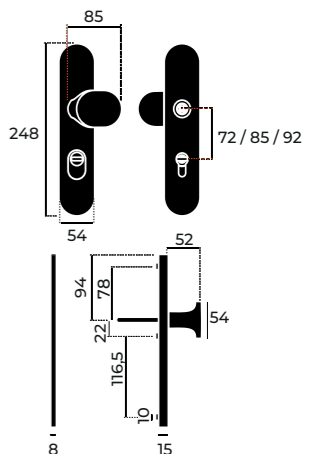

SECURITY HARDWARE

PROTECTORES DE CILINDRO HARDWARE DE SEGURIDAD

Os protectores de cilindro aumentam o nível de segurança, permitem a instalação no lado exterior de um escudete de segurança, dando maior protecção contra tentativas de arrombamento do cilindro /

Cylinder protection increase the level of security, allow installation on the outside of a security shield, giving greater protection against attempts to break into the cylinder. /

Los protectores de cilindro aumentan el nivel de seguridad y pueden instalarse en el exterior de un escudo de seguridad, proporcionando una mayor protección contra los intentos de forzar el cilindro.



Cylindrical Security escutcheon

IN.04.29S.FR / Set

Escudete de alta segurança ajustável para cilindro europeu. Sistema automático de ajuste à espessura da porta /

High security protection rose for european cylinder. Automatic adjust to the thickness of the door /

Escudo de alta seguridad ajustable para cilindro. Con ajuste automatico al espesor de la puerta.

EN 1.4301 - AISI 304
Satinado | Satin

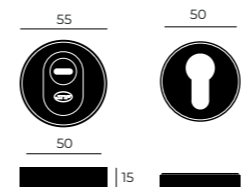

Square Security escutcheon

IN.04.30S / Set

Escudete de alta segurança ajustável para cilindro europeu. Sistema automático de ajuste à espessura da porta /

High security protection rose for european cylinder. Automatic adjust to the thickness of the door /

Escudo de alta seguridad ajustable para cilindro. Con ajuste automatico al espesor de la puerta.



FLUSH HANDLES FOR DOORS AND FURNITURE



IN.16.225.40 / Un.
IN.16.225.50 / Un.
IN.16.225.70 / Un.
IN.16.225.110 / Un.

Concha de embutir |
Flush handle |
Cazoleta

EN 1.4301 - AISI 304
Satinado | Satin

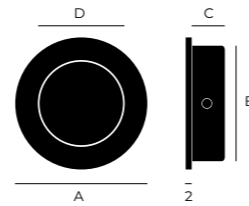
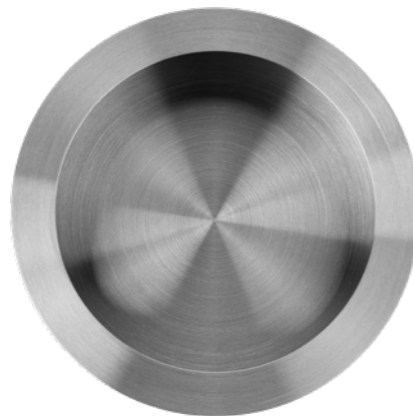

IN.16.225.110
Satinado | Satin
Ø110 mm



REF.	A	B	C	D
IN.16.225.40	40	35	10	26
IN.16.225.50	50	40	10	32
IN.16.225.70	70	60	14	49
IN.16.225.110	110	102	14	86

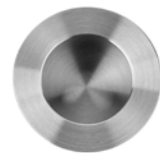

IN.16.225.40
Satinado | Satin
Ø40 mm

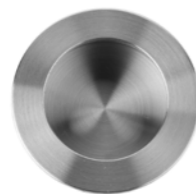

IN.16.225.50
Satinado | Satin
Ø50 mm

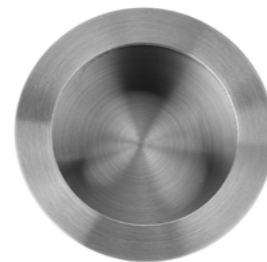

IN.16.225.70
Satinado | Satin
Ø70 mm



IN.16.225.40.BA / Un.
IN.16.225.50.BA / Un.
IN.16.225.70.BA / Un.
IN.16.225.110.BA / Un.

Concha de embutir |
Flush handle |
Cazoleta

EN 1.4301 - AISI 304
RAW Black Aged

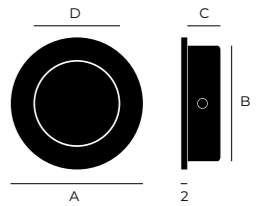

IN.16.225.110.BA
RAW Black Aged
Ø110 mm



REF.	A	B	C	D
IN.16.225.40.BA	40	35	10	26
IN.16.225.50.BA	50	40	10	32
IN.16.225.70.BA	70	60	14	49
IN.16.225.110.BA	110	102	14	86



IN.16.225.40.BA
RAW Black Aged
Ø40 mm



IN.16.225.50.BA
RAW Black Aged
Ø50 mm



IN.16.225.70.BA
RAW Black Aged
RAW - Ø70 mm





Flush handle Raw Black Aged

IN.16.416.BA / Un.

Concha de embutir /
Flush handle /
Cazoleta.

300 x 55 x 19 mm

EN 1.4301 - AISI 304
RAW Black Aged

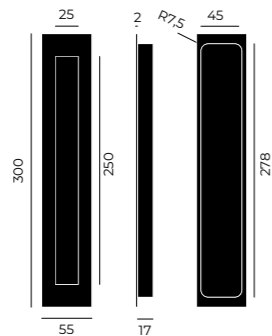

Flush handle Raw Black Aged

IN.16.410.BA / Un.

Concha de embutir /
Flush handle /
Cazoleta.

135 x 70 x 19 mm

EN 1.4301 - AISI 304
RAW Black Aged

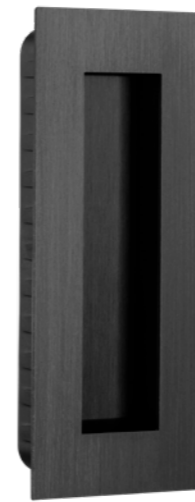
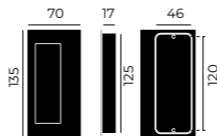

Flush handle Raw Black Aged

IN.16.412.BA / Un.

Concha de embutir /
Flush handle /
Cazoleta.

135 x 55 x 19 mm

EN 1.4301 - AISI 304
RAW Black Aged

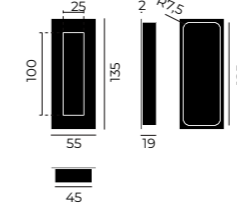

Flush handle Raw Black Aged

IN.16.414.BA / Un.

Concha de embutir /
Flush handle /
Cazoleta.

60 x 60 x 19 mm

EN 1.4301 - AISI 304
RAW Black Aged

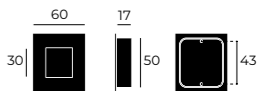

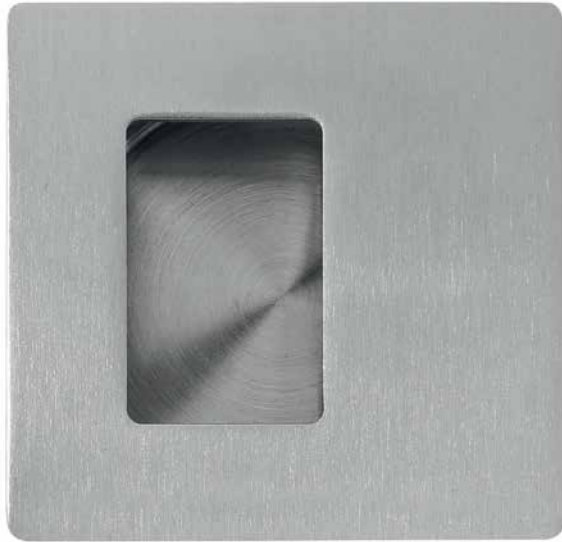

Square flush handle Descentered

IN.16.224.110 / Un.

Concha de embutir /
Concealed flush handle /
Cazoleta de embutir.

EN 1.4301 - AISI 304
Satinado | Satin



A	B	C	D	E
110X110	68X34	Ø102	14	2

Square flush handle Descentered

IN.16.224.70 / Un.

Concha de embutir /
Concealed flush handle /
Cazoleta de embutir.

EN 1.4301 - AISI 304
Satinado | Satin

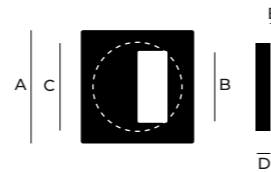

A	B	C	D	E
70X70	40X25	Ø60	14	2



Square flush handle Centered

IN.16.223.70 / Un.

Concha de embutir /
Concealed flush handle /
Cazoleta de embutir.

EN 1.4301 - AISI 304
Satinado | Satin

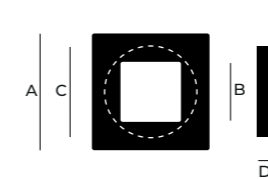

A	B	C	D	E
70X70	40X40	Ø60	14	2



Square flush handle Centered

IN.16.223.50 / Un.

Concha de embutir /
Concealed flush handle /
Cazoleta de embutir.

EN 1.4301 - AISI 304
Satinado | Satin

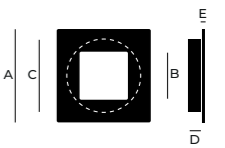

A	B	C	D	E
50X50	26X26	Ø40	10	2



Oval flush handle

Invisible fixing screws

IN.16.233 / Un.

Concha de embutir / Concealed flush handle / Cazoleta de embutir

EN 1.4301 - AISI 304
Satinado | Satin

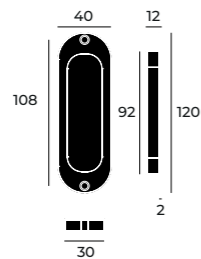

Oval flush handle

Visible fixing screws

IN.16.226 / Un.

Concha de embutir / Concealed flush handle / Cazoleta de embutir.

EN 1.4301 - AISI 304
Satinado | Satin

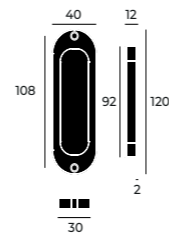

Oval flush handle

Invisible fixing

IN.16.227 / Un.

Concha de embutir / Concealed flush handle / Cazoleta de embutir.

EN 1.4301 - AISI 304
Satinado | Satin

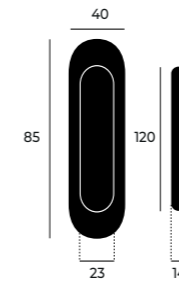

Rectangular flush handle

Invisible fixing

IN.16.228 / Un.

Concha de embutir / Concealed flush handle / Cazoleta de embutir.

EN 1.4301 - AISI 304
Satinado | Satin

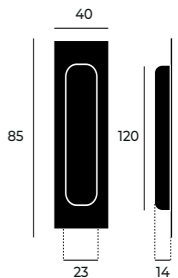

CONCEALED FLUSH HANDLES

CONCHAS DE EMBUTIR
PARA PORTAS E MOBILIÁRIO /
CAZOLETAS DE EMBUTIR
PARA PUERTAS Y MUEBLES.



Retractable handle For pocket doors

IN.16.319 / Un.

Concha de embutir |
Concealed flush handle |
Cazoleta de embutir.

EN 1.4301 - AISI 304
Satinado | Satin

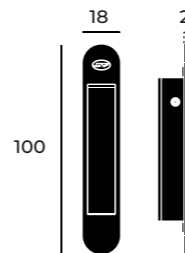

Retractable handle Flush turning knob

IN.16.050 / Un.

Concha de embutir com
puxador retráctil |
Concealed flush handle with
retractable handle |
Cazoleta de embutir con
manilla retráctil.

EN 1.4301 - AISI 304
Satinado | Satin

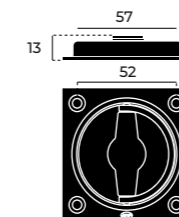
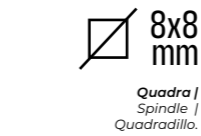

Concealed Snib indicator

IN.04.241 / Set

Fecho wc de embutir com ranhura
para moeda sem indicador |
Concealed bathroom snib indicator
with coin slot without color indication |
Condena de baño de embutir con
fenda para moneda sin indicador.

EN 1.4301 - AISI 304
Satinado | Satin

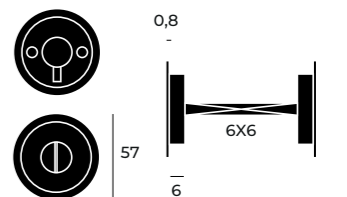

2

ASAS DE PORTA | PULL HANDLES MANILLONES DE PUERTA.



Pull handle Descentered

IN.07.320 / Pr

Asa de porta dupla |
Double door handle |
Manillon de puerta doble.

EN 1.4301 - AISI 304
Satinado | Satin

Acessórios | Accessories
MFU M8 included
Preparada para vidro |
Ready for glass

SEMI SOLID

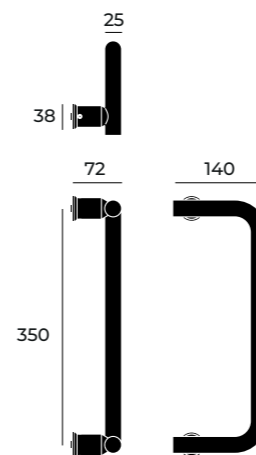

Pull handle Descentered

IN.07.321 / Pr

Asa de porta dupla |
Double door handle |
Manillon de puerta doble.

EN 1.4301 - AISI 304
Satinado | Satin

Acessórios | Accessories
MFU M8 included
Preparada para vidro |
Ready for glass

SEMI SOLID

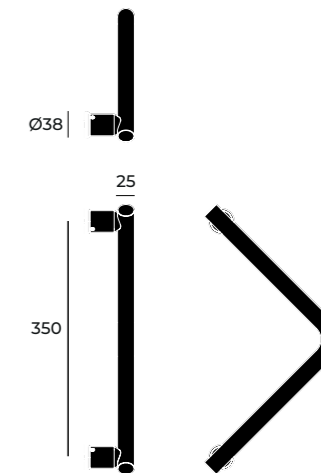

3

DOBRADIÇAS + PIVOTS / **HINGES +** **PIVOTS /** BISAGRAS + PIVOTES

3.1
DOBRADIÇA INVISÍVEL /
CONCEALED HINGE /
BISAGRA DE EMBUTIR.

3.2
DOBRADIÇAS |
HINGES |
BISAGRAS.

3.3
DOBRADIÇA SOBREPOR /
FLAT HINGE /
BISAGRA DE SOBREPONER.

3.4
DOBRADIÇAS DE PIANO |
PIANO HINGES |
BISAGRAS DE PIANO.

3.5
DOBRADIÇA COM MOLA /
HINGE WITH SPRING /
BISAGRA CON MUELLE.

3.6
GIRO PARA PORTAS /
PIVOT FOR DOORS /
PIVOTE PARA PUERTAS.



Nos casos em que é necessário classificar as dobradiças de acordo com o sentido de abertura da porta é aconselhável a consulta dos esquemas seguintes.

In case that is required to classify the hinges accordingly to the way to opening the door it is recommended the consultation of the following drawings.

En los casos donde es necesario clasificar los pernios el sentido de apertura de la puerta es recomendable la consulta de los dibujos siguientes.

Esquerda - Left hand - Izquierda

Exemplo / Example / Ejemplo
REF. IN.05.019.75.E

Porta esquerda para a encomenda adicionar à referência a letra "E" /
Left hand door to order add to the ref. letter "E" /
Puerta izquierda a la orden agregar a la referencia la letra "E".

Direita - Right hand - Derecha

Exemplo / Example / Ejemplo
REF. IN.05.019.75.D

Porta direita para a encomenda adicionar à referência a letra "D" /
Right hand door to order add to the ref. letter "D" /
Puerta derecha a la orden agregar a la referencia la letra "D".

CÁLCULO DO NÚMERO DE DOBRADIÇAS

AS DOBRADIÇAS SÃO PROJECTADAS PARA SUPORTAR UMA CARGA ESPECÍFICA. O peso, a largura e a altura da porta, a frequência e o tipo de utilização ou eventuais acessórios nela instalados são decisivos para a escolha da dobradiça mais adequada. O cálculo da carga provável a suportar pelas dobradiças é de grande importância para o correcto funcionamento da porta e dos seus acessórios. De forma a simplificar o cálculo do número de dobradiças por porta e por motivos de segurança, é aconselhável aplicar sempre 3 dobradiças conforme esquema 1. Mediante o tipo de utilização previsto, analisar a necessidade de aplicar a 4ª dobradiça.

1º PASSO

A) Determinar peso da porta.
B) Determinar a percentagem de incremento ao peso da porta, caso seja necessário mediante as dimensões da porta e utilização prevista para a mesma (Portas com largura superior a 1 metro ou com aplicação de ferragens complementares).

B1) Relação de altura / largura - $f = H / L$
Se $f \geq 2$ - Não será necessário ajuste.
Se $f < 2$ - Calcular percentagem de incremento.

Fórmula: $\% X = (2 - H / L) * 100$

Exemplos:

Porta com 2 x 0,8 metros
 $\Rightarrow f = 2 / 0,8 = 2,5 \Rightarrow OK$

Porta com 2 metros por 1,15 metros
 $\Rightarrow f = 2 / 1,15 = 1,74 \Rightarrow X = (2 - 1,74) * 100 = 26 \%$

Nota:
Portas com medidas específicas: altura superior a 2,1 metros, Pedido sob consulta.

CALCULATION OF THE NUMBER OF HINGES

THE HINGES ARE DESIGNED TO WITHSTAND A SPECIFIC LOAD. The weight, width and height of the door, frequency and type of use or any accessories installed are decisive for choosing the most appropriate hinge. The calculation of the load to be supported by the hinges is of great importance for the proper operation of the door and its fittings. In order to simplify the calculation of number of hinges by door, and for safety reasons, is always advisable to apply 3 hinges as schedule 1. By type of use envisaged, analyze the necessity to apply the 4th hinge.

Step 1

A) Determine weight of the door.
B) Determine the percentage to increase the weight of the door, if necessary by the dimensions of the door and intended use of the same. (Doors with width bigger than 1 meter or with additional hardware installed).

B1) Ratio of height / width - $f = H / L$
If $f \geq 2$ - Don't need adjustment.
If $f < 2$ - Calculate the percentage of the increase.

Fórmula: $\% X = (2 - H / L) * 100$

Examples:

Door with 2 meters by 0,8 meters
 $\Rightarrow f = 2 / 0,8 = 2,5 \Rightarrow OK$

Door with 2 meters by 1,15 meters
 $\Rightarrow f = 2 / 1,15 = 1,74 \Rightarrow X = (2 - 1,74) * 100 = 26 \%$

Note:
Doors with specific measures: Height exceeding 2,1 meters, on request

EL CÁLCULO DEL NÚMERO DE BISAGRAS / PERNIOS

Las bisagras están diseñadas para soportar una carga específica. El peso, el ancho y la altura de la puerta, la frecuencia y tipo de uso o cualquier otro accesorio instalados son determinantes para elegir el número adecuado de bisagras. El cálculo de la carga a soportar por las bisagras es de gran importancia para el buen funcionamiento de la puerta y de sus accesorios. Con el fin de simplificar el cálculo del número de bisagras por puerta, y por razones de seguridad, siempre es recomendable la aplicación de 3 bisagras como el esquema 1. Según el tipo de uso previsto, analizar la necesidad de implementar la cuarta bisagra.

Paso 1

A) Determinar el peso de la puerta.
B) determinar el porcentaje de aumento del peso de la puerta, si es necesario por las dimensiones de la puerta y el destino de los mismos. (Puertas con ancho superior a 1 metro o con aplicación de accesorios complementarios).

B1) Relación altura / ancho - $f = H / L$
Se $f \geq 2$ - No es necesario ajuste
Se $f < 2$ - Calcular porcentaje del incremento.

Fórmula: $\% X = (2 - H / L) * 100$

Ejemplos:

Puerta con 2 metros por 0,8 metros
 $\Rightarrow f = 2 / 0,8 = 2,5 \Rightarrow OK$

Puerta con 2 metros por 1,15 metros
 $\Rightarrow f = 2 / 1,15 = 1,74 \Rightarrow X = (2 - 1,74) * 100 = 26 \%$

Nota:
Puertas con medidas específicas: altura superior a 2,1 metros, Pedido sob consulta.

Portas / Doors / Puertas		F	% x De incremento no peso da porta / % x increase of the door weight / % x incremento del peso de la puerta
Altura (mm) / Height (mm) /	Largura (mm) / Length (mm) /		
2000	1000	2,00	0
2000	1050	1,90	10
2000	1100	1,82	18
2000	1150	1,74	26
2000	1200	1,66	33
2000	1250	1,60	40

B2) UTILIZAÇÃO PREVISTA:
Instalação mola aérea: + 20 %
Instalação mola aérea com paragem: + 75 %
Frequência de utilização elevada: + 30 %
Frequência de utilização abusiva: + 75 %

Peso teórico = Peso real + Incrementos

Exemplo:
Porta de madeira com 2 metros de altura por 1,15 metros de largura e 35mm de espessura, com mola aérea instalada para uma utilização de frequência elevada.

Peso real = 40Kg

Incrementos:
Dimensão: + 26 % => 10,4Kg
Mola aérea: + 20 % => 8Kg
Frequência elevada: + 30 % => 12Kg

Peso teórico = 40Kg + 10,4Kg + 8Kg + 12Kg = 70,4Kg

2º PASSO

Escolher o modelo de dobradiça a aplicar, em função do peso real e utilização prevista. As dobradiças encontram-se classificadas segundo a norma europeia EN 1935:2002, conforme o seguinte quadro:

Condições de utilização Use conditions	Primeiro dígito First digit		Segundo dígito Second digit		Terceiro dígito Third digit		Quarto dígito Fourth digit		Quinto dígito Fifth digit		Sexto dígito Sixth digit		Sétimo dígito Seventh digit		Oitavo dígito Eighth digit	
	Categoria de utilização Use category		Ensaio de durabilidade (ciclos) Endurance test (cycles)		Massa da porta de ensaio Test door weight		Adequação ao fogo / fumo Suitable for fire proof		Segurança de pessoas People security		Resistência à corrosão Corrosion resistance		Segurança de bens Goods security		Grau da dobradiça Hinge grade	
	Grau Grade	Utilizar em / use in	Grau Grade	Numero de ciclos Number of cycles	Grau Grade	Massa Mass Kg	Graus disponíveis Available grades	Graus disponíveis Available grades	Graus disponíveis Available grades	Graus disponíveis Available grades	Graus disponíveis Available grades	Graus disponíveis Available grades	Graus disponíveis Available grades	Graus disponíveis Available grades		
Ligeira / Light	1	Janelas / windows	3	10 000	0	10	0 ou 1	1	0,1,2,3,4	0 ou 1	1	1	0 ou 1	1		
Ligeira / Light	1	Janelas / windows	3	10 000	1	20	0 ou 1	1	0,1,2,3,4	0 ou 1	1	1	0 ou 1	2		
Ligeira / Light	1	Janelas Portas / windows Doors	4	25 000	1	20	0 ou 1	1	0,1,2,3,4	0 ou 1	1	1	0 ou 1	3		
Média / Medium	2	Portas / Doors	7	200 000	1	20	0 ou 1	1	0,1,2,3,4	0 ou 1	1	1	0 ou 1	4		
Ligeira / Light	1	Janelas / windows	3	10 000	2	40	0 ou 1	1	0,1,2,3,4	0 ou 1	1	1	0 ou 1	5		
Ligeira / Light	1	Janelas Portas / windows Doors	4	25 000	2	40	0 ou 1	1	0,1,2,3,4	0 ou 1	1	1	0 ou 1	6		
Média / Medium	2	Portas / Doors	7	200 000	2	40	0 ou 1	1	0,1,2,3,4	0 ou 1	1	1	0 ou 1	7		
Ligeira / Light	1	Janelas / windows	3	10 000	3	60	0 ou 1	1	0,1,2,3,4	0 ou 1	1	1	0 ou 1	8		
Ligeira / Light	1	Janelas Portas / windows Doors	4	25 000	3	60	0 ou 1	1	0,1,2,3,4	0 ou 1	1	1	0 ou 1	9		
Média / Medium	2	Portas / Doors	7	200 000	3	60	0 ou 1	1	0,1,2,3,4	0 ou 1	1	1	0 ou 1	10		
Elevada / High	3	Portas / Doors	7	200 000	4	80	0 ou 1	1	0,1,2,3,4	0 ou 1	1	1	0 ou 1	11		
Severa / Severe	4	Portas / Doors	7	200 000	5	100	0 ou 1	1	0,1,2,3,4	0 ou 1	1	1	0 ou 1	12		
Severa / Severe	4	Portas / Doors	7	200 000	6	120	0 ou 1	1	0,1,2,3,4	0 ou 1	1	1	0 ou 1	13		
Severa / Severe	4	Portas / Doors	7	200 000	7	160	0 ou 1	1	0,1,2,3,4	0 ou 1	1	1	0 ou 1	14		

2 7 3 0 1 3 0 10

Exemplo / Example / Ejemplo

Corresponde a uma dobradiça para utilização média, submetida a ensaio de 200.000 ciclos destinada a ser utilizada em portas com um peso máximo de 60Kg, sem especificação de resistência ao fogo. Não se encontra apta para uso em portas de segurança. Em função do peso teórico, determinar a necessidade de aplicar a 4ª dobradiça.

PESO TEÓRICO - PESO REAL = X
Se $X = 0$ - aplicar apenas 3 dobradiças
Se $0 < X \leq 20$ - aplicar a 4ª dobradiça
Se $X > 20$ escolher dobradiça com carga superior.

Corresponde to a hinge for medium use, submitted to 200.000 cycles test. Is suitable to use on doors with a maximum weight of 60Kg, without specifying fire resistance. Is not suitable for use in security doors. Depending on the theoretical weight, determine the need to apply 4th hinge.

THEORETICAL WEIGHT - WEIGHT REAL = X
If $X = 0$ - apply only 3 hinges
If $0 < X \leq 20$ - apply 4 th hinges
If $X > 20$ choose hinge with high capacity.

Corresponde a una bisagra de utilización mediada, pruebada con 200.000 ciclos, su uso es para puertas con un peso máximo de 60Kg, sin especificar resistencia al fuego. Es apto para el uso en las puertas de seguridad. Dependiendo del peso teórico, determinar la necesidad de aplicar la 4ª bisagra.

PESO TEÓRICO - PESO REAL = X
Si $X = 0$ - se aplican sólo 3 bisagras
Si $0 < X \leq 20$ - se aplican 4ª bisagras
Si $X > 20$ elijir bisagra con carga superior.

**CLASSIFICAÇÃO DE UTILIZAÇÃO:
(1º DÍGITO)**

Grau 1 – Utilização Ligeira
Dobradiças para utilização em portas ou janelas de habitações e em edifícios onde exista uma baixa frequência de utilização por utilizadores muito cuidadosos e com os quais exista uma probabilidade muito baixa de ocorrência de acidentes ou de utilização indevida. (Situações domésticas, escritórios e áreas onde não há acesso do público geral)

Grau 2 – Utilização Média
Dobradiças para utilização em portas ou janelas de habitações e em edifícios onde exista uma frequência média de utilização por utilizadores com algum cuidado e com os quais exista alguma probabilidade de ocorrência de acidentes ou de utilização indevida. (Situações domésticas, escritórios e áreas onde existe um acesso limitado do público geral)

Grau 3 – Utilização Elevada
Dobradiças para utilização em portas de edifícios onde existe uma frequência elevada de utilização por utilizadores com pouco cuidado e com uma elevada probabilidade de ocorrência de acidentes ou de má utilização. (Edifícios públicos e institucionais, como bibliotecas, hospitais e escolas)

Grau 4 – Utilização Severa
Dobradiças para utilização em portas que são objecto de utilização frequentemente violenta. (Dobradiças de grau 12, quando é provável uma má utilização intencional)

3º Passo
Aplicação de dobradiças numa porta
A marcação do posicionamento das dobradiças deve ser feita como indicado no esquema 1.

As medições devem ser efectuadas a partir do meio da dobradiça (ponto M esquema 2)
A 1ª dobradiça e a 2ª devem ser colocadas a 237mm das extremidades da porta.
A 3ª dobradiça deve ser colocada a 370mm da 1ª dobradiça.

Exemplo de aplicação:

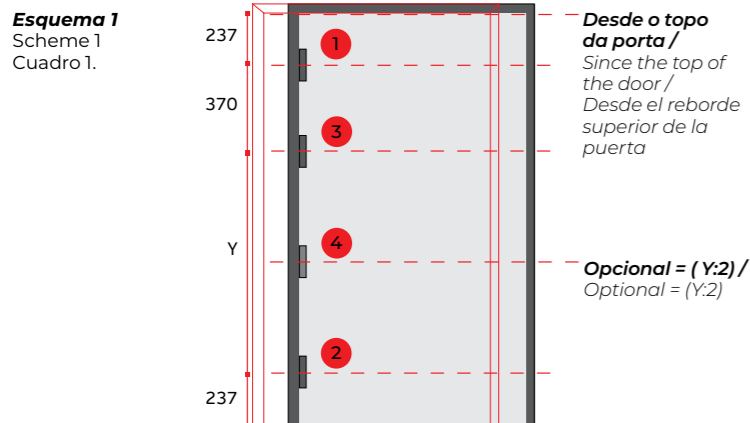

**USER RATING:
(1º DIGIT)**

Grade 1 - Light Use
Hinges to be used on doors and windows of houses and buildings where there is a low frequency of use by users that are very careful and with whom there is a very low probability of occurrence of accidents or misuse. (Domestic situations, offices and areas where there is no general public access).

Grade 2 - Medium Use
Hinges for use on doors and windows of houses and buildings where there is an average frequency of use by users with some care and with whom there is some likelihood of accidents or misuse. (Domestic situations, offices and areas where there is limited access to the general public)

Grade 3 - High Use
Hinges for doors in buildings where there is a high frequency of use by users with little care and a high probability of accidents or misuse. (Public and institutional buildings such as libraries, hospitals and schools)

Grade 4 - Severe Use
Hinges for doors that are often violently misused. (Hinges grade 12, when it is likely an intentional misuse)

Step 3
Application of a door hinge
The marking of the position of the hinges should be made as indicated in scheme 1.

Measurements should be made from the middle of the hinge (point M scheme 2)
The 1st and 2nd hinge should be placed at 237mm from the ends of the door.
The 3rd hinge should be placed 370mm from the 1st hinge.

Application example:

**CALIFICACIÓN DE UTILIZACIÓN:
(1º DÍGITO)**

Grado 1 - Uso Ligero
Bisagras para su uso en puertas y ventanas de casas y edificios donde hay una baja frecuencia de uso por los usuarios. (Situaciones domésticas, oficinas y las zonas donde no hay acceso al público en general)

Grado 2 - Uso Mediano
Bisagras para su uso en puertas y ventanas de casas y edificios donde hay una frecuencia media de utilización. (Situaciones domésticas, oficinas y las zonas donde hay un acceso limitado al público en general)

Grado 3 - Uso Elevado
Las bisagras de las puertas en los edificios donde hay una alta frecuencia de utilización por usuarios con poco cuidado y una alta probabilidad de accidentes o mal uso. (Edificios públicos y institucionales, tales como bibliotecas, hospitales y escuelas)

Grado 4 - Uso Severo
Las bisagras de las puertas que se utilizan indebidamente con frecuente violencia. (Grado Bisagras 12, cuando es probable un uso indebido intencional)

Paso 3
La aplicación de una bisagra de la puerta
El marcado de la posición de las bisagras debe hacerse como se indica en el cuadro 1.

Las mediciones deberían realizarse desde el centro de la bisagra (punto M punto 2)
La 1ª y 2ª bisagra debe colocarse en 237mm de los extremos de la puerta.
La 3ª bisagra debe ser colocado 370mm desde el 1 de bisagra.

Ejemplo de aplicación:

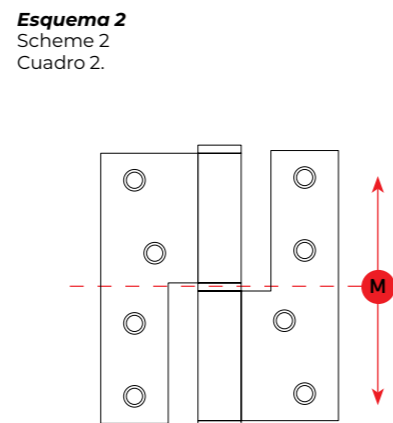

DOBRADIÇAS EM AÇO INOX

São fabricadas com aço EN 1.4372. A resistência à corrosão atmosférica fornecida por estes aços é boa. De um ponto de vista da aparência, estas classes geralmente são suficientemente resistentes, na maioria dos ambientes, com excepção de zonas costeiras, onde o material EN 1.4301 ou material EN 1.4401, outros graus mais elevados, devem ser usados.

Em áreas industriais pesadas ou poluídas, a lavagem é importante para evitar a formação de depósitos, que podem causar corrosão.

STAINLESS STEEL HINGES

Made with stainless steel EN 1.4372. The resistance to atmospheric corrosion provided by these grades is good. From an appearance point of view, these grades are usually sufficiently resistant in most environments, with the exception of marine and coastal, where Material: EN 1.4301 or Material: EN 1.4401 higher alloyed grades should be used.

In heavy industrial or polluted areas, washing is important to prevent the formation of deposits, which can cause corrosion.

BISAGRAS EN ACERO INOX

Fabricadas com acero inox EN 1.4372. La resistencia a la corrosión atmosférica proporcionada por estos grados es buena. Desde el punto de vista de la apariencia, estos grados de suelen ser lo suficientemente resistentes en la mayoría de los ambientes, con excepción de los marinos y costeros, en que los grados Material: EN 1.4301 o Material: EN 1.4401 los grados más altos de aleación se debe utilizar.

En las zonas industriales pesadas o contaminadas, el lavado es importante para prevenir la formación de depósitos, que pueden causar corrosión.

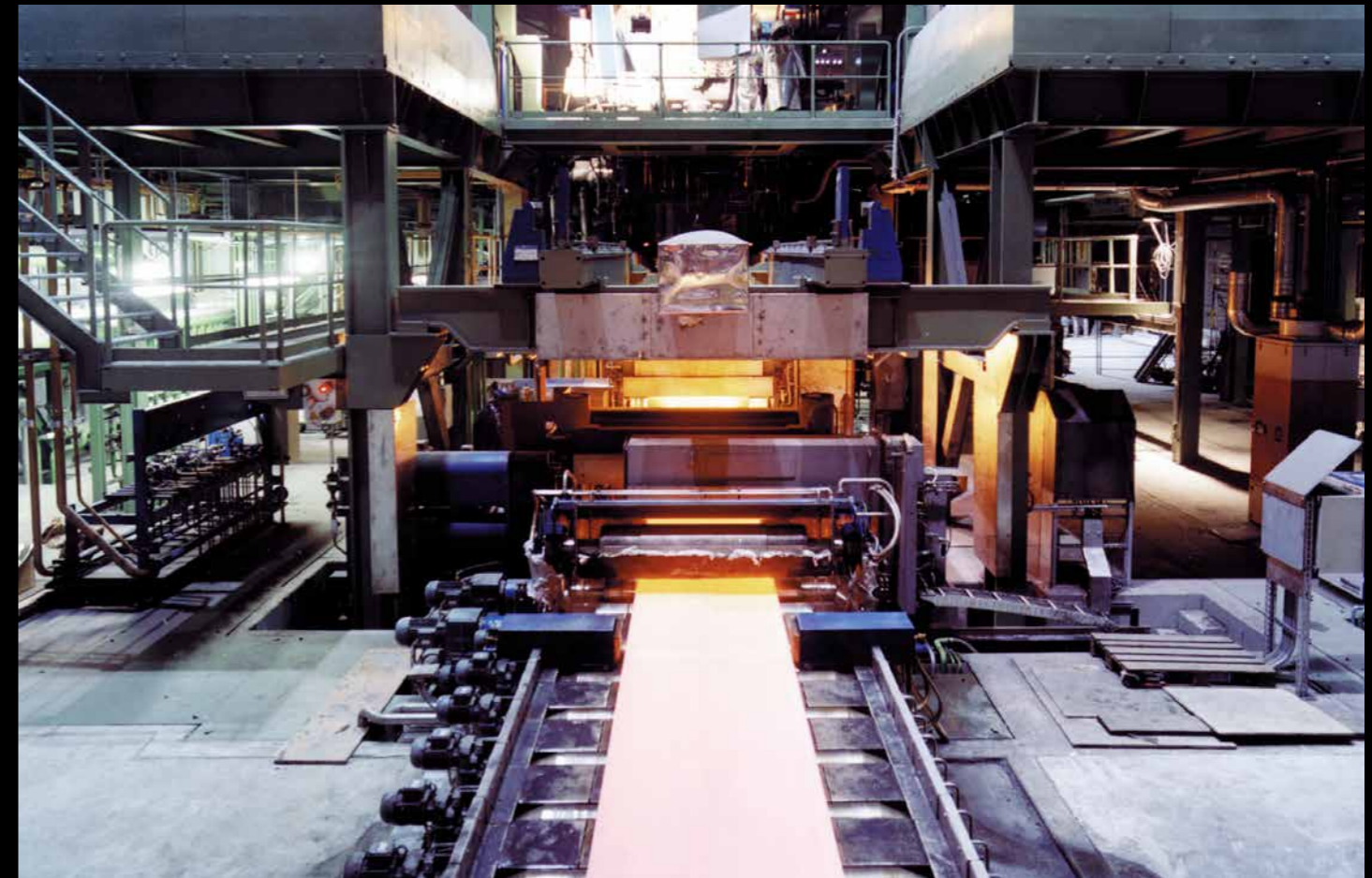

O aço utilizado no fabrico desta série de dobradiças mais económicas é o EN 1.4372 em que a percentagem de níquel mínima é de 2,5% e máxima de 5%, aço inoxidável não magnético e resistência à corrosão por nevoeiro salino de 48h grau 2 da norma NP EN 1670. Trata-se de um aço inoxidável com um comportamento aceitável contra a corrosão.

The steel used in the manufacture of this economical series of hinges is the EN 1.4372 where the percentage of nickel minimum is 2.5% and a maximum of 5%, non-magnetic stainless steel and corrosion resistance by salt spray saline teste over than 48h grade 2 standard norm EN 1670. This is a stainless steel with an acceptable behavior against corrosion.

El acero utilizado en la fabricación de esta serie de bisagras económicas es el EN 1.4372 con el porcentaje de níquel mínimo de 2,5% y un máximo del 5%, tratase de acero inoxidable no magnético y resistencia a la corrosión por la niebla salina de 48h grado 2 norma EN 1670. Se trata de un acero inoxidable con un comportamiento aceptable contra la corrosión.

CONCEALED HINGES



DOBRADIÇA INVISÍVEL PARA MOBILIÁRIO E PORTAS DE EDIFÍCIOS

Gama de dobradiças invisíveis, desenvolvidas para utilização em mobiliário e portas de edifícios interiores ou exteriores.

- Permitem um ângulo de abertura até aos 180°
- Possibilidade de aplicar em portas até 60Kg.
- O desenho das dobradiças possibilita a mecanização das portas e aros, facilitando a instalação e garantindo uma grande precisão.
- Possibilidade de instalar em portas a partir de 16mm de espessura.

CONCEALED HINGE FOR BUILDING DOORS AND FURNITURE

The invisible hinges was developed to for use in furniture and doors interior or exterior.

- Allow an opening angle up to 180°
- Ability to apply up to 60Kg doors.
- The design of the hinges allows mechanization of doors and frames, facilitating installation and ensuring a great accuracy.
- Possibility to install in doors from 16mm thickness.

BISAGRA DE EMBUTIR PARA MUEBLES E PUERTAS DE EDIFICIO

La gama de bisagras invisibles se desarrolló para su uso en los muebles y las puertas interiores o exteriores de los edificios.

- Permiten un ángulo de apertura de hasta 180°
- Capacidad de aplicar hasta 60Kg puertas.
- El diseño de las bisagras permite la mecanización de puertas y marcos, facilitando la instalación y garantizando una gran precisión.
- Posibilidad de instalar en las puertas desde los 16mm de espesor.

NORMA / NORM / NORMA	L1	L2	L3	L4	L5	T1	T2	Max. Kg.
EN1935 1310120 2	45	19	13	21	8	5	12	10
EN1935 1410120 3	60	32	13	22	9	6	12	20
EN1935 2710120 4	70	34	16	27	11	7	16	20
* EN1935 2721120 7	95	52	19	32	13	10	17	20
* EN1935 2731120 10	118	65	27	50	23	12	28	40
	139	75	34	45/80	28	12	37	60

*
Para cumprir corta fogo:
-Dobradiça invisível + kit intumescente /
To meet fire proof:
-Concealed hinge + intumescent kit /
Para satisfacer a prueba de fuego:
-Bisagra invisible + kit intumescente

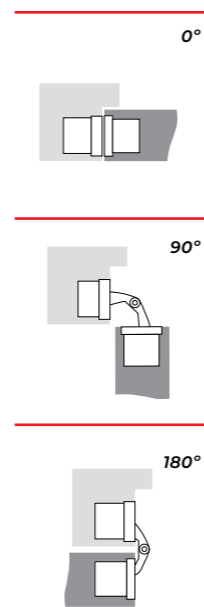
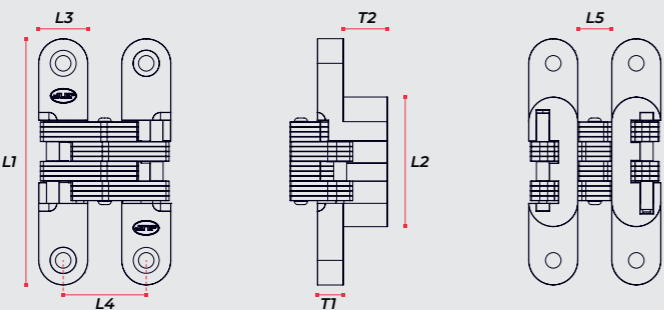



Concealed hinge 139 for doors

IN.05.051.139 / Un.
KA.05.051.139 / Set
(INTUMESCENT KIT)

*Dobradiça invisível
para portas de edifícios /
Concealed hinge for building doors /
Bisagra de embutir para
puertas de edificios.*

EN 1.4301 + Zamak
Satinado / Satin

EN1935 **273112010**

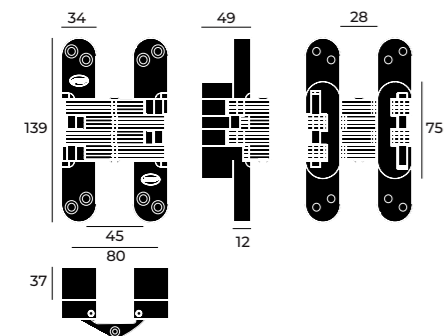

Concealed hinge 118 for doors

IN.05.051.118 / Un.
KA.05.051.118 / Set
(INTUMESCENT KIT)

*Dobradiça invisível
para portas de edifícios /
Concealed hinge for building doors /
Bisagra de embutir para
puertas de edificios.*

EN 1.4301 + Zamak
Satinado / Satin

EN1935 **27211207**

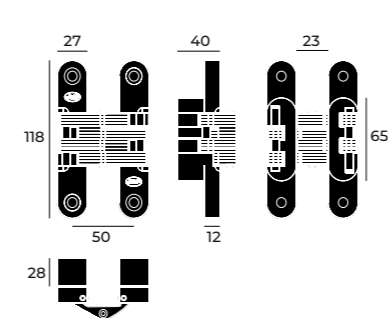

Concealed hinge 95 for doors

IN.05.051.95 / Un.

*Dobradiça invisível
para portas de edifícios /
Concealed hinge for building doors /
Bisagra de embutir para
puertas de edificios.*

EN 1.4301 + Zamak
Satinado / Satin

EN1935 **27101204**

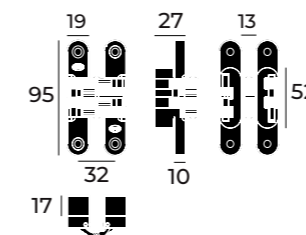

Concealed hinge 70 for doors

IN.05.051.70 / Un.

*Dobradiça invisível
para portas de edifícios /
Concealed hinge for building doors /
Bisagra de embutir para
puertas de edificios.*

EN 1.4301 + Zamak
Satinado / Satin

EN1935 **14101203**

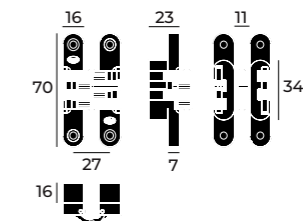



Concealed hinge 60 for furniture

IN.05.051.60 / Un.

*Dobradiça invisível para
portas de mobiliário /
Concealed hinge for
furniture doors /
Bisagra de embutir para
puertas de muebles.*

EN 1.4301 + Zamak
Satinado / Satin

EN1935 13101202

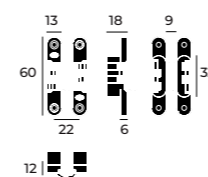
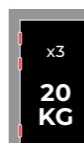

Concealed hinge 45 for furniture

IN.05.051.45 / Un.

*Dobradiça invisível para
portas de mobiliário /
Concealed hinge for
furniture doors /
Bisagra de embutir para
puertas de muebles.*

EN 1.4301 + Zamak
Satinado / Satin

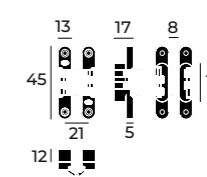



new

Concealed hinge 139 for doors

IN.05.051.139.B / Un.
KA.05.051.139 / Set
(INTUMESCENT KIT)

*Dobradiça invisível
para portas de edifícios /
Concealed hinge for building doors /
Bisagra de embutir para
puertas de edificios.*

RAL 9005
Preto / Black / Negro

EN1935 2731120 10

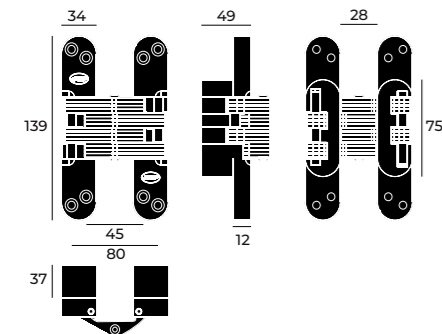

new

Concealed hinge 118 for doors

IN.05.051.118.B / Un.
KA.05.051.118 / Set
(INTUMESCENT KIT)

*Dobradiça invisível
para portas de edifícios /
Concealed hinge for building doors /
Bisagra de embutir para
puertas de edificios.*

RAL 9005
Preto / Black / Negro

EN1935 2721120 7

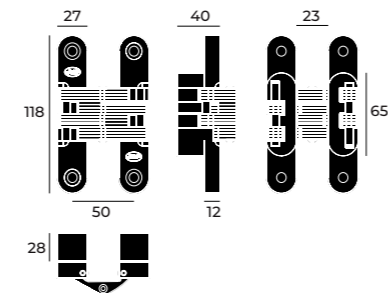

new

Concealed hinge 95 for doors

IN.05.051.95.B / Un.

*Dobradiça invisível
para portas de edifícios /
Concealed hinge for building doors /
Bisagra de embutir para
puertas de edificios.*

RAL 9005
Preto / Black / Negro

EN1935 2710120 4

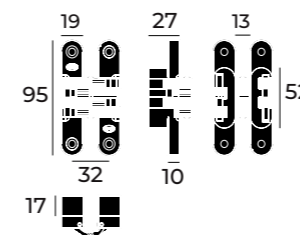

new

Concealed hinge 70 for doors

IN.05.051.70.B / Un.

*Dobradiça invisível
para portas de edifícios /
Concealed hinge for building doors /
Bisagra de embutir para
puertas de edificios.*

RAL 9005
Preto / Black / Negro

EN1935 1410120 3

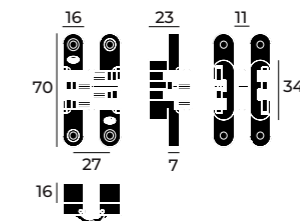



new

Concealed hinge 60 for furniture

IN.05.051.60.B / Un.

*Dobradiça invisível para
portas de mobiliário /
Concealed hinge for
furniture doors /
Bisagra de embutir para
puertas de muebles.*

RAL 9005
Preto / Black / Negro

EN1935 1 3 1 0 1 2 0 2

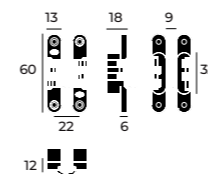

new

Concealed hinge 45 for furniture

IN.05.051.45.B / Un.

*Dobradiça invisível para
portas de mobiliário /
Concealed hinge for
furniture doors /
Bisagra de embutir para
puertas de muebles.*

RAL 9005
Preto / Black / Negro

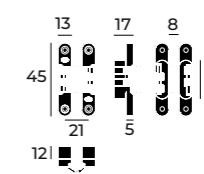

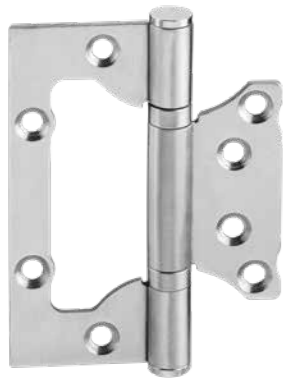

ECO
series

Butterfly hinge 100

Overlap installation

IN.05.030.ECO / Un.

Dobradiça de bandeira, reversível de sobrepor /
Flag type hinge reversible to overlap /
Bisagra de bandera reversible de sobreponer.
EN 1.4372 AISI 201 - Satinado | Satin

EN1935 1410130 3

IN.05.030.NS / Un.

Dobradiça de bandeira, reversível de sobrepor /
Flag type hinge reversible to overlap /
Bisagra de bandera reversible de sobreponer.
Steel - Satinado | Satin

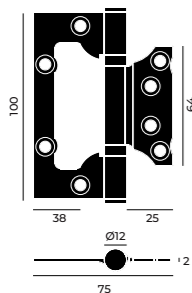

new

Flag type hinge 304

Overlap installation

IN.05.011.D / Un.
(Direita / Right / Derecha)
IN.05.011.E / Un.
(Esquerda / Left / Izquierda)

Dobradiça de bandeira, reversível de sobrepor /
Flag type hinge reversible to overlap /
Bisagra de bandera reversible de sobreponer.

EN 1.4301 - AISI 304
Satinado | Satin

EN1935 2710130 7

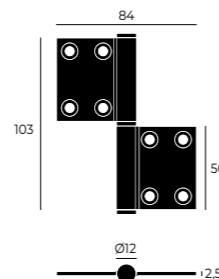

ECO
series

Flag type hinge 100

Overlap installation

IN.05.010 / Un.

Dobradiça de bandeira, reversível de sobrepor /
Flag type hinge reversible to overlap /
Bisagra de bandera reversible de sobreponer.

EN 1.4372 - AISI 201
Satinado | Satin

EN1935 2710130 7

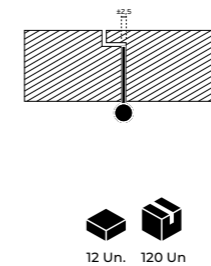
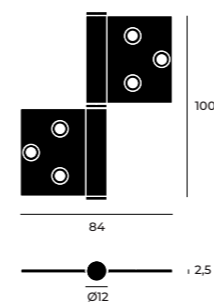



Z type hinge 100

For rebated doors

IN.05.026.D / Un.
IN.05.026.E / Un.

Dobradiça de abas quinadas.
(direita ou esquerda) /
Lift off hinge with folded leaves.
(right or left hand) /
Bisagra desmontable de codo.
(derecha o izquierda).

EN 1.4301 - AISI 304
Satinado | Satin

EN1935 2730130 10

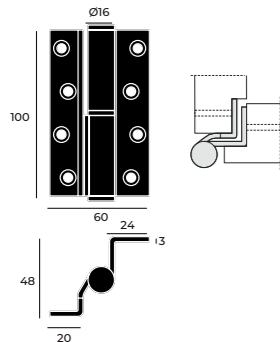
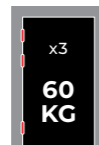

ECO
series

Half leaf hinge 90

Lift off hinge

IN.05.023.D.ECO / Un.
IN.05.023.E.ECO / Un.

Dobradiça de meio balanço com cantos
redondos (direita ou esquerda) /
Lift off hinge with round corners
(right or left hand) /
Bisagra desmontable con esquinas
redondeadas. (derecha o izquierda).

EN 1.4372 - AISI 201
Satinado | Satin

EN1935 2720120 7

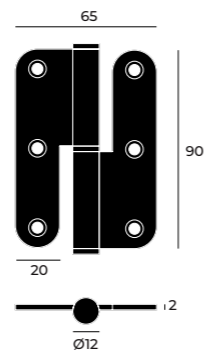
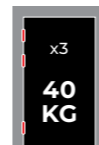

ECO
series

Butt hinge 75

Reversible

IN.05.060.ECO / Un.

Dobradiça de eixo amovível /
Butt hinge /
Bisagra de eje desmontable.

EN 1.4372 - AISI 201
Satinado | Satin

EN1935 2710120 4

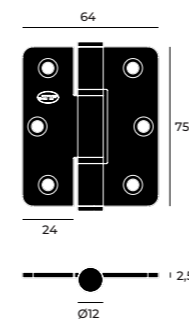

Pozidrive

Hinge screws

IN.05.PDE.A / 100 Un.

Parafuso Pozidrive para madeira 4x25mm /
Pozidrive screw for wood 4x25mm /
Tornillo Pozidrive para madera 4x25mm.

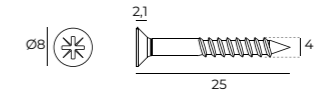

Torx

Hinge screws

IN.05.PDT / 100 Un.

Parafuso TORX para madeira 4x25mm /
TORX Screw for wood 4x25mm /
Tornillo TORX para madera 4x25mm.

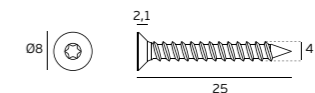



Piano hinge 40 / 30

Installation by screws

IN.05.113.40 / Un.
IN.05.113.30 / Un.

Dobradiça de piano para instalação por parafusos. Reversível | Piano hinge to install by screws. Reversible | Bisagra de piano para instalar por tornillos. Reversible.

EN 1.4301 - AISI 304
Satinado | Satin

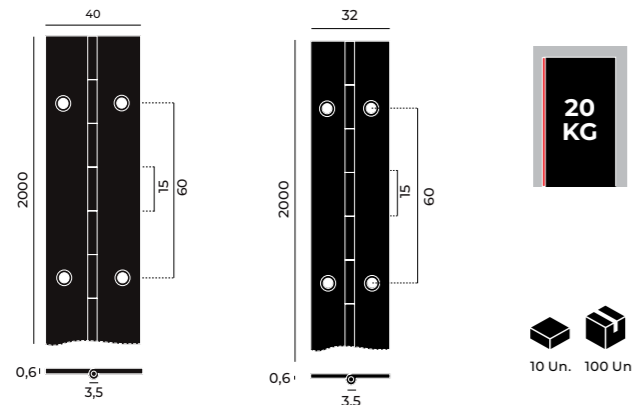

Piano hinge 25 / 20

Installation by screws

IN.05.113.25 / Un.
IN.05.113.20 / Un.

Dobradiça de piano para instalação por parafusos. Reversível | Piano hinge to install by screws. Reversible | Bisagra de piano para instalar por tornillos. Reversible.

EN 1.4301 - AISI 304
Satinado | Satin

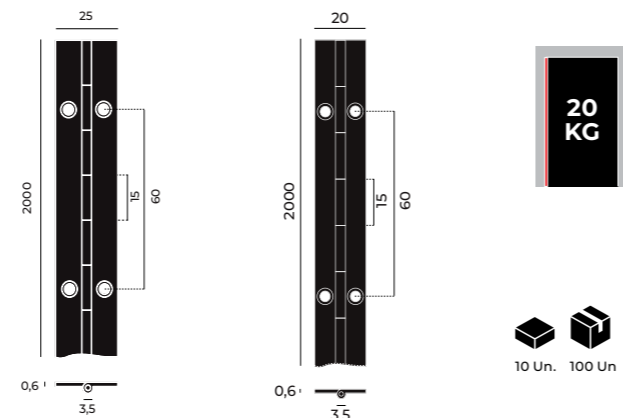

Piano hinge 40 / 30

Installation by welding

IN.05.114.40 (0,6mm) / Un.
IN.05.114.30 (0,6mm) / Un.
IN.05.115.40 (1,0mm) / Un.
IN.05.115.30 (1,0mm) / Un.

Dobradiça de piano para instalar por soldadura. Reversível | Piano hinge to install by welding. Reversible | Bisagra de piano para instalar por soldadura. Reversible.

EN 1.4301 - AISI 304 - Satinado | Satin

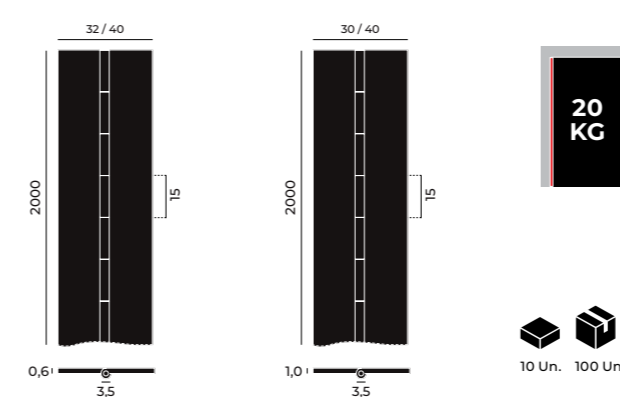

Piano hinge 40 / 30 / 25

Installation by screws

DOPFN0840 (NICKEL PLATED) / Un.
DOPFN0830 (NICKEL PLATED) / Un.
DOPFL0840 (BRASS PLATED) / Un.
DOPFL0830 (BRASS PLATED) / Un.
DOPFL0825 (BRASS PLATED) / Un.

Dobradiça de piano para instalação por parafusos. Reversível | Piano hinge to install by screws. Reversible | Bisagra de piano para instalar por tornillos. Reversible.

Steel

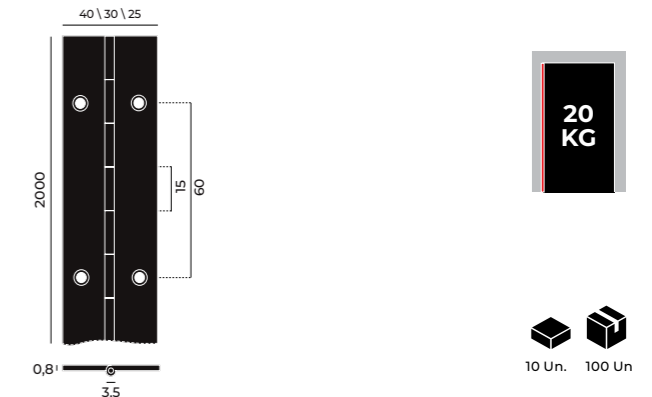

Spring hinges

DOBRADIÇAS COM MOLA

- Para portas de batente ou "vai-vem"
- Com rolamentos de esferas
- Baixa manutenção
- Com mola de torção
- Material: aço inox EN 1.4301
- Força ajustável
- Utilização média

SPRING HINGES

- For single or double action doors
- With ball bearings
- Low maintenance
- With torsion spring
- Material: stainless steel EN 1.4301
- Adjustable power
- Medium use

BISAGRAS CON MUELLE

- Para puertas de double o simple accion
- Con rodamientos
- Bajo mantenimiento
- Con muelles de torsion
- Material: acero inox EN 1.4301
- Fuerza ajustable
- Uso mediano

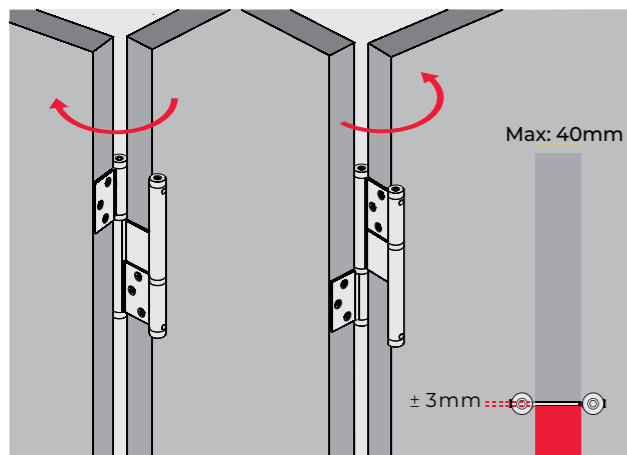
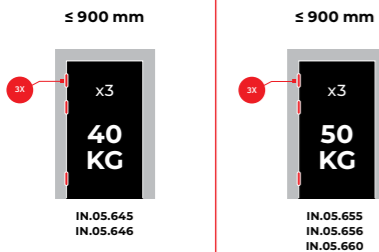

Double action hinge Spring loaded 180

IN.05.660 / Un.

Dobradiça de "vai-vem" de sobrepor com mola para auto-fecho. Reversível. Mola com força ajustável. 2 rolamentos de esferas / Flat double action hinge to overlap with spring for self closing. Reversible. Spring with power adjustment. 2 ball bearings / Bisagra de doble action de sobreponer con muelle para autocierre. Reversible. Muelle con ajuste de fuerza. 2 rodamientos.

EN 1.4301 - AISI 304
Satinado | Satin

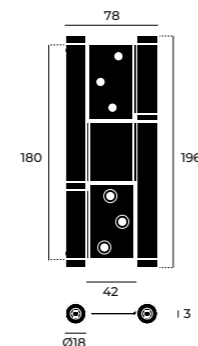

Novo sistema de mola de torção / New torsion spring system / Nuevo sistema de muelle de torsion.



Rolamentos de esferas / Ball bearings / Rodamientos de bolas.



Double action hinge Spring loaded 180

IN.05.655 / Un.

Dobradiça de "vai-vem" com mola para auto-fecho. Reversível. Mola com força ajustável. 10 rolamentos de esferas / Double action hinge with spring for self closing. Reversible. Spring with power adjustment. 10 ball bearings / Bisagra de doble action con muelle para autocierre. Reversible. Muelle con ajuste de fuerza. 10 rodamientos.

EN 1.4301 - AISI 304
Satinado | Satin

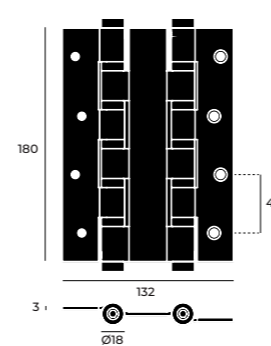

Novo sistema de mola de torção / New torsion spring system / Nuevo sistema de muelle de torsion.



Rolamentos de esferas / Ball bearings / Rodamientos de bolas.



Double action hinge Spring loaded 120

IN.05.645 / Un.

Dobradiça de "vai-vem" com mola para auto-fecho. Reversível. Mola com força ajustável. 6 rolamentos de esferas / Double action hinge with spring for self closing. Reversible. Spring with power adjustment. 6 ball bearings / Bisagra de doble action con muelle para autocierre. Reversible. Muelle con ajuste de fuerza. 6 rodamientos.

EN 1.4301 - AISI 304
Satinado | Satin

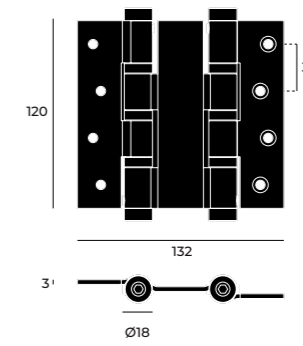

Novo sistema de mola de torção / New torsion spring system / Nuevo sistema de muelle de torsion.



Rolamentos de esferas / Ball bearings / Rodamientos de bolas.



Single action hinge

Spring loaded 180

IN.05.656 / Un.

*Dobradiça com mola para auto-fecho. Reversível.
Mola com força ajustável. 5 rolamentos de esferas /
Hinge with spring for self closing. Reversible.
Spring with power adjustment. 5 ball bearings /
Bisagra con muelle para autocierre. Reversible.
Muelle con ajuste de fuerza. 5 rodamientos.*

EN 1.4301 - AISI 304
Satinado | Satin

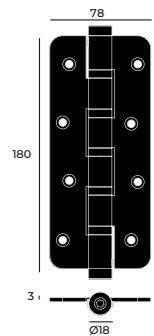
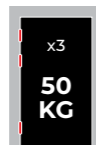

2 Un. 12 Un



Rolamentos de esferas /
Ball bearings /
Rodamientos de bolas.

Novo sistema de mola de torção /
New torsion spring system /
Nuevo sistema de muelle de torsion.



Single action hinge

Spring loaded 120

IN.05.646 / Un.

*Dobradiça com mola para auto-fecho. Reversível.
Mola com força ajustável. 3 rolamentos de esferas /
Hinge with spring for self closing. Reversible.
Spring with power adjustment. 3 ball bearings /
Bisagra con muelle para autocierre. Reversible.
Muelle con ajuste de fuerza. 3 rodamientos.*

EN 1.4301 - AISI 304
Satinado | Satin

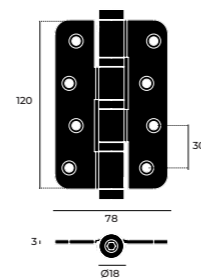
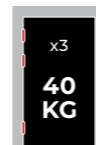

2 Un. 24 Un



Rolamentos de esferas /
Ball bearings /
Rodamientos de bolas.

Novo sistema de mola de torção /
New torsion spring system /
Nuevo sistema de muelle de torsion.



Single action hinge

Spring loaded 180

IN.05.656.R / Un.

*Dobradiça com mola para auto-fecho. Reversível.
Mola com força ajustável. 5 rolamentos de esferas /
Hinge with spring for self closing. Reversible.
Spring with power adjustment. 5 ball bearings /
Bisagra con muelle para autocierre. Reversible.
Muelle con ajuste de fuerza. 5 rodamientos.*

EN 1.4301 - AISI 304
Satinado | Satin

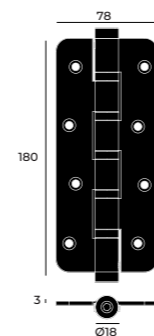

2 Un. 12 Un



Rolamentos de esferas /
Ball bearings /
Rodamientos de bolas.

Novo sistema de mola de torção /
New torsion spring system /
Nuevo sistema de muelle de torsion.



Single action hinge

Spring loaded 120

IN.05.646.R / Un.

*Dobradiça com mola para auto-fecho. Reversível.
Mola com força ajustável. 3 rolamentos de esferas /
Hinge with spring for self closing. Reversible.
Spring with power adjustment. 3 ball bearings /
Bisagra con muelle para autocierre. Reversible.
Muelle con ajuste de fuerza. 3 rodamientos.*

EN 1.4301 - AISI 304
Satinado | Satin

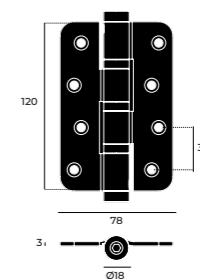

2 Un. 24 Un



Rolamentos de esferas /
Ball bearings /
Rodamientos de bolas.

Novo sistema de mola de torção /
New torsion spring system /
Nuevo sistema de muelle de torsion.

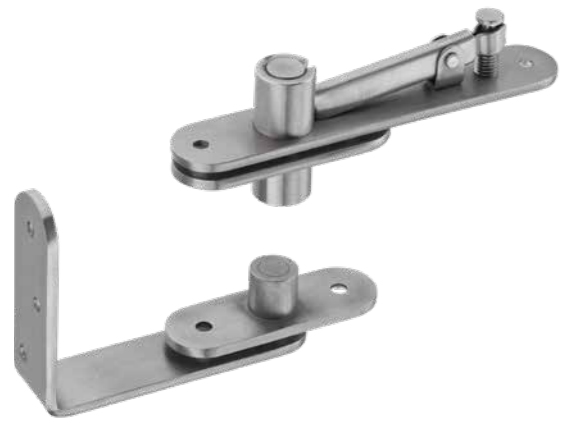

Double action pivot

Holding on the frame

IN.05.195 / Set

Giro para portas de batente ou "vai-ven". Pivot inferior de fixação ao aro e com rolamento. Pivot superior com sistema de alavanca para instalação simples | Pivot for double or single action doors. Lower pivot to instal in the frame and with ball bearing. Upper pivot with lever system for easy installation | Pivote para puerta "vai-ven" o de batiente. Pivote inferior de instalación en el marco y con rodamiento. Pivote superior con sistema de palanca para facilitar la instalación.

80
KG

EN 1.4301 - AISI 304
Satinado | Satin

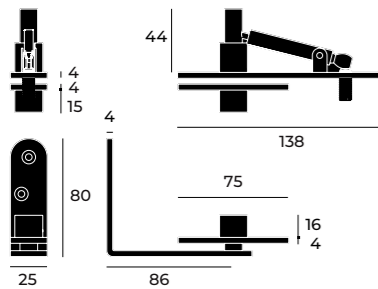

Double action pivot

Invisible on the floor

IN.05.194 / Set

Giro para portas de batente ou "vai-ven". Pivot inferior oculto com rolamento. Pivot superior com sistema de alavanca para instalação simples | Pivot for double or single action doors. Invisible lower pivot with bearing. Upper pivot with lever system for easy installation | Pivote para puerta "vai-ven" o de batiente. Pivote inferior oculto con rodamiento. Pivote superior con sistema de palanca para facilitar la instalación.

80
KG

EN 1.4301 - AISI 304
Satinado | Satin

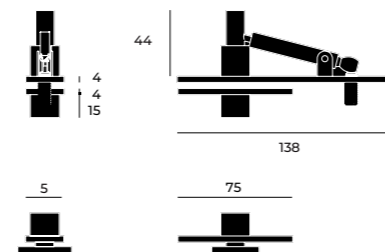

Double action pivot

Square shape

IN.05.196.0.ECO / Set

Giro para portas de batente ou "vai-ven". Pivot inferior com rolamento. Pivot superior com sistema de alavanca para instalação simples | Pivot for double or single action doors. Lower pivot with bearing. Upper pivot with lever system for easy installation | Pivote para puerta "vai-ven" o de batiente. Pivote inferior con rodamiento. Pivote superior con sistema de palanca para facilitar la instalación.

100
KG

EN 1.4372 - AISI 201
Satinado | Satin

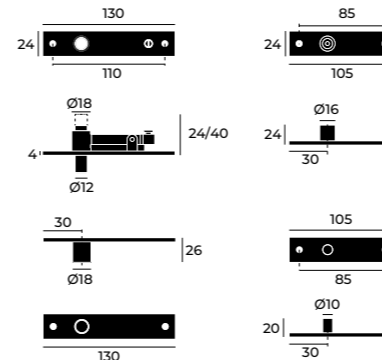

Pivot System

for rebated doors

IN.05.230 / Set

Sistema de pivot para portas de batente. Reversível / Pivot system for rebated doors. Reversible / Sistema pivotante para puertas de batente. Reversible

EN 1.4301 - AISI 304
Satinado | Satin

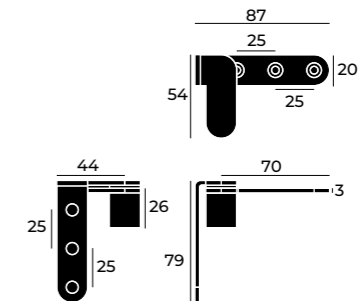

4

FERRAGENS PARA MOBILIÁRIO

FURNITURE HARDWARE

HERRAJES PARA MUEBLE.

4.1
PUXADOR DE MÓVEL /
FURNITURE KNOB /
POMO DE MUEBLE.

4.2
CONCHA DE EMBUTIR /
CONCEALED FLUSH HANDLE /
CAZOLETA DE EMBUTIR.

4.3
ASA DE MÓVEL /
FURNITURE HANDLE /
TIRADOR DE MUEBLE.

4.4
CHROMIUM FREE
SERIES





Two lines Knob

ø10 / ø14 x 22mm

IN.22.107.10 / Un.
IN.22.107.14 / Un.

Puxador de móvel, com parafuso M4 para instalação |
Furniture knob with M4 screw for installation |
Pomo de mueble con tornillo M4 para instalación.
EN 1.4301 - AISI 304 Satinado | Satin

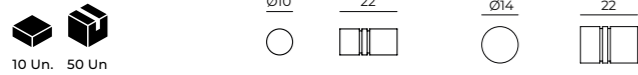

Cone Knob

ø12 / ø18mm

new

IN.22.116.12 / Un.
IN.22.116.18 / Un.

Puxador de móvel, com parafuso M4 para instalação |
Furniture knob with M4 screw for installation |
Pomo de mueble con tornillo M4 para instalación.
EN 1.4301 - AISI 304 Satinado | Satin

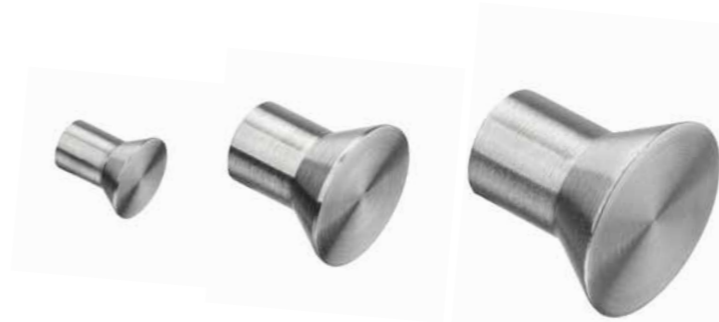

Flat Cone Knob

ø15 / ø20 / ø25

new

IN.22.112.15 / Un.
IN.22.112.20 / Un.
IN.22.112.25 / Un.

Puxador de móvel, com parafuso M4 para instalação |
Furniture knob with M4 screw for installation |
Pomo de mueble con tornillo M4 para instalación.
EN 1.4301 - AISI 304 Satinado | Satin

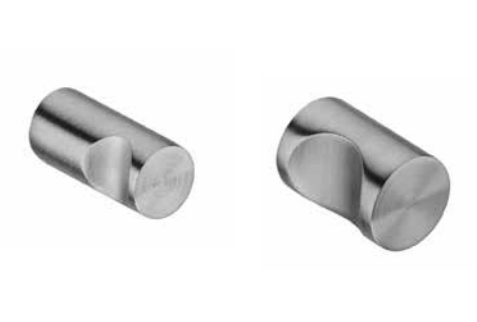
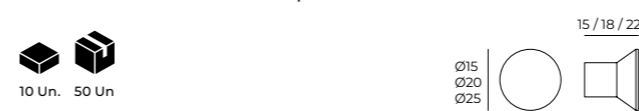

Finger Knob

ø10 / ø14 x 20mm

IN.22.102.10 / Un.
IN.22.102.14 / Un.

Puxador de móvel, com parafuso M4 para instalação |
Furniture knob with M4 screw for installation |
Pomo de mueble con tornillo M4 para instalación.
EN 1.4301 - AISI 304 Satinado | Satin

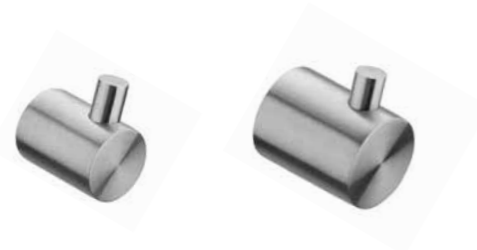
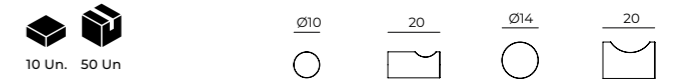

Pin Knob

ø15 / ø19

IN.22.108.15 / Un.
IN.22.108.19 / Un.

Puxador de móvel, com parafuso M4 para instalação |
Furniture knob with M4 screw for installation |
Pomo de mueble con tornillo M4 para instalación.
EN 1.4301 - AISI 304 Satinado | Satin

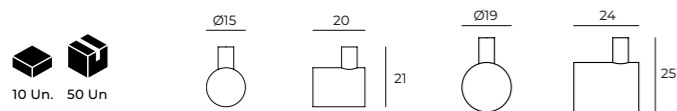

Flat Finger Knob

ø19 x 25mm

new

IN.22.100 / Un.

Puxador de móvel, com parafuso M4 para instalação |
Furniture knob with M4 screw for installation |
Pomo de mueble con tornillo M4 para instalación.
EN 1.4301 - AISI 304 Satinado | Satin

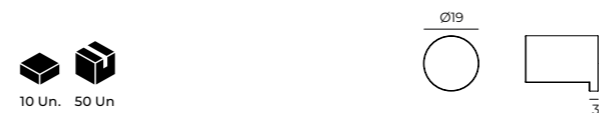

Finger Knob

ø19 x 25mm

IN.22.102.19 / Un.

Puxador de móvel, com parafuso M4 para instalação |
Furniture knob with M4 screw for installation |
Pomo de mueble con tornillo M4 para instalación.
EN 1.4301 - AISI 304 Satinado | Satin



Finger Knob

ø25 x 28mm

IN.22.102.25 / Un.

Puxador de móvel, com parafuso M4 para instalação |
Furniture knob with M4 screw for installation |
Pomo de mueble con tornillo M4 para instalación.
EN 1.4301 - AISI 304 Satinado | Satin





Orb knob

ø15 x 20mm

IN.22.111.15 / Un.

Puxador de móvel, com parafuso M4 para instalação |
Furniture knob with M4 screw for installation |
Pomo de mueble con tornillo M4 para instalación.
EN 1.4301 - AISI 304 Satinado | Satin



10 Un. 50 Un

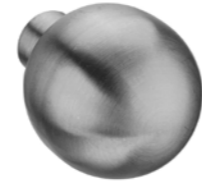

Orb knob

ø20 x 25mm

IN.22.111.20 / Un.

Puxador de móvel, com parafuso M4 para instalação |
Furniture knob with M4 screw for installation |
Pomo de mueble con tornillo M4 para instalación.
EN 1.4301 - AISI 304 Satinado | Satin



10 Un. 50 Un



Oblong Knob

h26 x cc32

IN.22.211.26 / Un.

Puxador de móvel, com parafuso M4 para instalação |
Furniture knob with M4 screw for installation |
Pomo de mueble con tornillo M4 para instalación.
EN 1.4301 - AISI 304 Satinado | Satin



10 Un. 50 Un

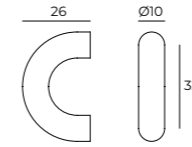

Oblong Knob

h40 x cc32

IN.22.211.40 / Un.

Puxador de móvel, com parafuso M4 para instalação |
Furniture knob with M4 screw for installation |
Pomo de mueble con tornillo M4 para instalación.
EN 1.4301 - AISI 304 Satinado | Satin



10 Un. 50 Un

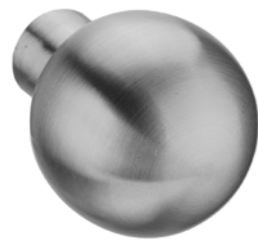
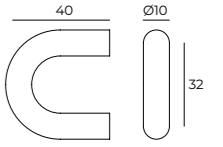

Orb knob

ø25 x 33mm

IN.22.111.25 / Un.

Puxador de móvel, com parafuso M4 para instalação |
Furniture knob with M4 screw for installation |
Pomo de mueble con tornillo M4 para instalación.
EN 1.4301 - AISI 304 Satinado | Satin



5 Un. 25 Un

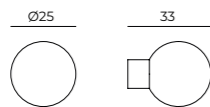

Orb knob

ø30 x 35mm

IN.22.111.30 / Un.

Puxador de móvel, com parafuso M4 para instalação |
Furniture knob with M4 screw for installation |
Pomo de mueble con tornillo M4 para instalación.
EN 1.4301 - AISI 304 Satinado | Satin



5 Un. 25 Un

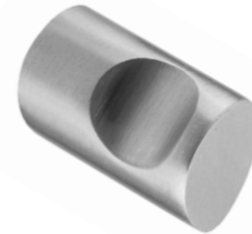
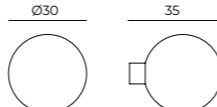

Ergo form Knob

24 / 21 x 34mm

IN.22.124 / Un.

Puxador de móvel, com parafuso M4 para instalação |
Furniture knob with M4 screw for installation |
Pomo de mueble con tornillo M4 para instalación.
EN 1.4301 - AISI 304 Satinado | Satin



5 Un. 20 Un

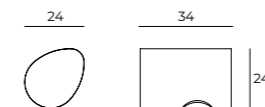

Quadro series 10x10

h35 x cc32

IN.22.200.10.032 / Un.

Puxador de móvel, com parafuso M4 para instalação |
Furniture knob with M4 screw for installation |
Pomo de mueble con tornillo M4 para instalación.
EN 1.4301 - AISI 304 Satinado | Satin



20 Un. 100 Un

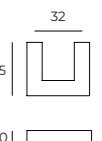



Nautic handle

44x38mm

IN.16.108 / Un.

Concha de embutir com mola /
Concealed flush handle with spring /
Cazoleta de embutir con muelle.
EN 1.4301 - AISI 304 Satinado | Satin

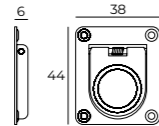

Nautic handle

65x55mm

IN.16.109 / Un.

Concha de embutir com mola /
Concealed flush handle with spring /
Cazoleta de embutir con muelle.
EN 1.4301 - AISI 304 Satinado | Satin

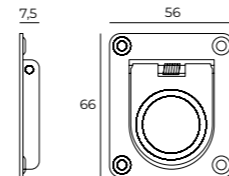

Nautic handle

Ø55mm

IN.16.107 / Un.

Concha de embutir com mola /
Concealed flush handle with spring /
Cazoleta de embutir con muelle.
EN 1.4301 - AISI 304 Satinado | Satin

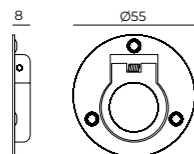

Nautic handle

58x75mm

IN.16.110 / Un.

Concha de embutir com mola /
Concealed flush handle with spring /
Cazoleta de embutir con muelle.
EN 1.4301 - AISI 304 Satinado | Satin

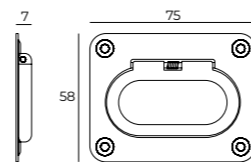

Ø8

Tubular Ø8

Furniture handles

IN.22.202.08.064 / Un.
IN.22.202.08.096 / Un.
IN.22.202.08.128 / Un.
IN.22.202.08.160 / Un.
IN.22.202.08.224 / Un.

Asa de móvel, com parafusos M4 para instalação /
Furniture handle with M4 screws for installation |
Tirador de mueble con tornillos M4 para instalación.
EN 1.4301 - AISI 304 Satinado | Satin

C.C.	L	5 Un.	50 Un.	Ø8	35
64	72	25	250		
96	104	25	250		
128	136	25	250		
160	168	25	250		
224	232	25	150		



Ø10

Tubular Ø10

Furniture handles

IN.22.202.10.096 / Un.
IN.22.202.10.128 / Un.
IN.22.202.10.224 / Un.
IN.22.202.10.320 / Un.
IN.22.202.10.512 / Un.

Asa de móvel, com parafusos M4 para instalação /
Furniture handle with M4 screws for installation |
Tirador de mueble con tornillos M4 para instalación.
EN 1.4301 - AISI 304 Satinado | Satin

C.C.	L	H	5 Un.	50 Un.	Ø10	H
96	106	35	25	250		
128	138	35	25	150		
224	234	35	12	120		
320	330	35	12	120		
512	522	40	12	120		



Ø12

Intersection ø12 Furniture handles

IN.22.209.12.096 / Un.
IN.22.209.12.128 / Un.
IN.22.209.12.160 / Un.
IN.22.209.12.192 / Un.
IN.22.209.12.224 / Un.
IN.22.209.12.288 / Un.
IN.22.209.12.320 / Un.

Asa de móvel, com parafusos M4 para instalação |
Furniture handle with M4 screws for installation |
Tirador de mueble con tornillos M4 para instalación.
EN 1.4301 - AISI 304 Satinado | Satin

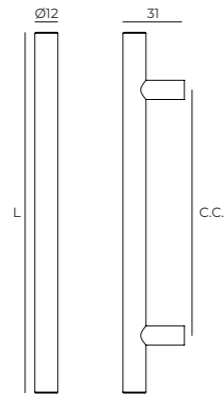

C.C.	L	⬇	⬆
96	156	12	120
128	188	12	120
160	220	12	120
192	252	12	120
224	284	12	120
288	348	12	72
320	380	12	72



Ø12

Intersection ø12 Furniture handles

IN.22.209.12.352 / Un.
IN.22.209.12.384 / Un.
IN.22.209.12.448 / Un.
IN.22.209.12.480 / Un.
IN.22.209.12.544 / Un.
IN.22.209.12.640 / Un.
IN.22.209.12.704 / Un.

Asa de móvel, com parafusos M4 para instalação |
Furniture handle with M4 screws for installation |
Tirador de mueble con tornillos M4 para instalación.
EN 1.4301 - AISI 304 Satinado | Satin

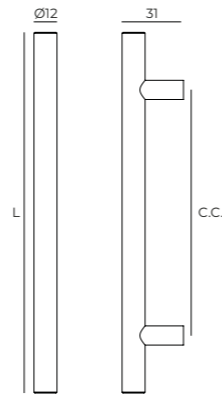

C.C.	L	⬇	⬆
352	412	12	72
384	444	12	72
448	508	12	72
480	540	12	72
544	604	12	48
640	700	12	48
704	744	12	48



Ø12

Intersection ø12 Furniture handles

IN.22.209.12.736 / Un.
IN.22.209.12.832 / Un.
IN.22.209.12.896 / Un.
IN.22.209.12.960 / Un.
IN.22.209.12.1184 / Un.
IN.22.209.12.1376 / Un.

Asa de móvel, com parafusos M4 para instalação |
Furniture handle with M4 screws for installation |
Tirador de mueble con tornillos M4 para instalación.
EN 1.4301 - AISI 304 Satinado | Satin

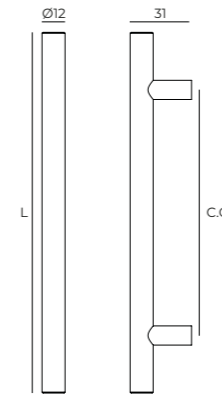

C.C.	L	⬇	⬆
736	796	6	36
832	892	6	36
896	956	6	36
960	1020	6	36
1184	1244	6	36
1376	1436	6	36



Ø10

T-eco handle ø10 Furniture handles

IN.22.209.10.096.ECO / Un.
IN.22.209.10.128.ECO / Un.
IN.22.209.10.160.ECO / Un.
IN.22.209.10.192.ECO / Un.
IN.22.209.10.224.ECO / Un.
IN.22.209.10.320.ECO / Un.

Asa de móvel, com parafusos M4 para instalação |
Furniture handle with M4 screws for installation |
Tirador de mueble con tornillos M4 para instalación.
EN 1.4372 - AISI 201 Satinado | Satin

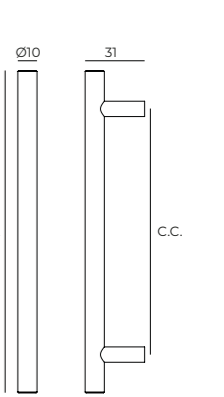

C.C.	L	⬇	⬆
96	136	12	120
128	168	12	120
160	200	12	120
192	232	12	120
224	264	12	120
320	360	12	72



Ø8

Ø12

Blend Ø8 / Ø12

Furniture handles

IN.22.212.096 / Un.
IN.22.212.128 / Un.

Asa de móvel, com parafusos M4 para instalação |
Furniture handle with M4 screws for installation |
Tirador de mueble con tornillos M4 para instalación.
EN 1.4301 - AISI 304 Satinado | Satin

C.C.	L	Ø8	Ø12
96	110	12	120
128	145	12	120



Ø10

Boomerang Ø10

Furniture handles

IN.22.210.096 / Un.
IN.22.210.128 / Un.
IN.22.210.160 / Un.

Asa de móvel, com parafusos M4 para instalação |
Furniture handle with M4 screws for installation |
Tirador de mueble con tornillos M4 para instalación.
EN 1.4301 - AISI 304 Satinado | Satin

C.C.	L	Ø10	30
96	130	25	250
128	160	20	200
160	180	20	200



Ø10

Arch Ø10

Furniture handles

IN.22.201.096 / Un.
IN.22.201.128 / Un.
IN.22.201.224 / Un.
IN.22.201.320 / Un.

Asa de móvel, com parafusos M4 para instalação |
Furniture handle with M4 screws for installation |
Tirador de mueble con tornillos M4 para instalación.
EN 1.4301 - AISI 304 Satinado | Satin

C.C.	L	Ø10	30
96	110	25	250
128	150	25	250
224	260	10	120
320	370	10	120



Ø10

Tear drop Ø10

Furniture handles

IN.22.215 / Un.

Asa de móvel, com parafusos M4 para instalação |
Furniture handle with M4 screws for installation |
Tirador de mueble con tornillos M4 para instalación.
EN 1.4301 - AISI 304 Satinado | Satin

C.C.	L	Ø10	30
140	128		

25 Un. 250 Un.



Ø10

Angulo Ø10

Furniture handles

IN.22.204.10.096 / Un.
IN.22.204.10.128 / Un.
IN.22.204.10.224 / Un.
IN.22.204.10.320 / Un.

Asa de móvel, com parafusos M4 para instalação |
Furniture handle with M4 screws for installation |
Tirador de mueble con tornillos M4 para instalación.
EN 1.4301 - AISI 304 Satinado | Satin

C.C.	L	▣	▣	Ø10	35
96	106	25	250		
128	138	25	250		
224	234	12	120		
320	330	12	120		



Ø16

Angulo Ø16

Furniture handles

IN.22.204.16.224 / Un.
IN.22.204.16.320 / Un.
IN.22.204.16.384 / Un.
IN.22.204.16.448 / Un.

Asa de móvel, com parafusos M4 para instalação |
Furniture handle with M4 screws for installation |
Tirador de mueble con tornillos M4 para instalación.
EN 1.4301 - AISI 304 Satinado | Satin

C.C.	L	▣	▣	Ø16	40
224	240	6	60		
320	336	6	60		
384	400	6	60		
448	464	6	60		



Ø16

Union Ø16

Furniture handles

IN.22.820.128 / Un.
IN.22.820.160 / Un.
IN.22.820.192 / Un.
IN.22.820.224 / Un.
IN.22.820.320 / Un.

Asa de móvel, com parafusos M4 para instalação |
Furniture handle with M4 screws for installation |
Tirador de mueble con tornillos M4 para instalación.
EN 1.4301 - AISI 304 Satinado | Satin

C.C.	L	▣	▣	Ø16	37
128	152	12	120		
160	184	12	120		
192	216	12	120		
224	248	12	120		
320	344	12	120		



Ø16

Union Ø16

Furniture handles

IN.22.820.400 / Un.
IN.22.820.448 / Un.
IN.22.820.592 / Un.
IN.22.820.688 / Un.
IN.22.820.800 / Un.

Asa de móvel, com parafusos M4 para instalação |
Furniture handle with M4 screws for installation |
Tirador de mueble con tornillos M4 para instalación.
EN 1.4301 - AISI 304 Satinado | Satin

C.C.	L	▣	▣	Ø16	37
400	424	6	60		
448	472	6	60		
592	616	6	60		
688	712	6	60		
800	824	6	60		



Quadro series 8x8

Furniture handles

IN.22.200.08.096 / Un.
IN.22.200.08.128 / Un.
IN.22.200.08.160 / Un.
IN.22.200.08.192 / Un.
IN.22.200.08.224 / Un.

Asa de móvel, com parafusos M4 para instalação |
Furniture handle with M4 screws for installation |
Tirador de mueble con tornillos M4 para instalación.
EN 1.4301 - AISI 304 Satinado | Satin

C.C.	L		
96	104	12	120
128	136	12	120
160	168	12	96
192	200	12	96
224	232	12	96



Quadro series 10x10

Furniture handles

IN.22.200.10.096 / Un.
IN.22.200.10.128 / Un.
IN.22.200.10.160 / Un.
IN.22.200.10.224 / Un.
IN.22.200.10.320 / Un.

Asa de móvel, com parafusos M4 para instalação |
Furniture handle with M4 screws for installation |
Tirador de mueble con tornillos M4 para instalación.
EN 1.4301 - AISI 304 Satinado | Satin

C.C.	L		
96	106	12	120
128	138	12	96
160	170	12	96
224	234	12	96
320	330	12	96



Quadro series 12x12

Furniture handles

IN.22.200.12.128 / Un.
IN.22.200.12.160 / Un.
IN.22.200.12.224 / Un.
IN.22.200.12.320 / Un.
IN.22.200.12.480 / Un.
IN.22.200.12.704 / Un.

Asa de móvel, com parafusos M4 para instalação |
Furniture handle with M4 screws for installation |
Tirador de mueble con tornillos M4 para instalación.
EN 1.4301 - AISI 304 Satinado | Satin

C.C.	L		
128	140	12	120
160	172	12	96
224	236	12	96
320	332	12	96
480	492	12	96
704	716	12	72



Quadro series 16x16

Furniture handles

IN.22.200.16.224 / Un.
IN.22.200.16.384 / Un.
IN.22.200.16.480 / Un.
IN.22.200.16.704 / Un.

Asa de móvel, com parafusos M4 para instalação |
Furniture handle with M4 screws for installation |
Tirador de mueble con tornillos M4 para instalación.
EN 1.4301 - AISI 304 Satinado | Satin

C.C.	L		
224	240	6	60
384	400	6	60
488	496	6	60
704	720	6	60



Linear 10x20

Furniture handles

IN.22.230.160 / Un.
IN.22.230.192 / Un.
IN.22.230.224 / Un.
IN.22.230.320 / Un.

Asa de móvel, com parafusos M4 para instalação |
Furniture handle with M4 screws for installation |
Tirador de mueble con tornillos M4 para instalación.
EN 1.4301 - AISI 304 Satinado | Satin

C.C.	L		
160	170	10	100
192	202	10	100
224	234	10	100
320	330	10	50



Linear 10x20

Furniture handles

IN.22.230.384 / Un.
IN.22.230.608 / Un.
IN.22.230.800 / Un.

Asa de móvel, com parafusos M4 para instalação |
Furniture handle with M4 screws for installation |
Tirador de mueble con tornillos M4 para instalación.
EN 1.4301 - AISI 304 Satinado | Satin

C.C.	L		
384	394	10	50
608	618	10	50
800	810	10	50



Square 22x22

Furniture handles

IN.22.318.288 / Un.
IN.22.318.384 / Un.

Asa de móvel, com parafusos M4 para instalação |
Furniture handle with M4 screws for installation |
Tirador de mueble con tornillos M4 para instalación.
EN 1.4301 - AISI 304 Satinado | Satin

C.C.	L		
288	310	6	60
384	406	6	60



Rectangular 20x10

Furniture handles

IN.22.224.160 / Un.
IN.22.224.224 / Un.
IN.22.224.320 / Un.
IN.22.224.488 / Un.
IN.22.224.704 / Un.

Asa de móvel, com parafusos M4 para instalação |
Furniture handle with M4 screws for installation |
Tirador de mueble con tornillos M4 para instalación.
EN 1.4301 - AISI 304 Satinado | Satin

C.C.	L		
160	176	12	96
224	240	12	96
320	400	12	96
488	496	12	48
704	720	12	24

C.C.	L		
160	176	12	96
224	240	12	96
320	400	12	96
488	496	12	48
704	720	12	24





Flat 20x6

Furniture handles

IN.22.218.128 / Un.
IN.22.218.160 / Un.

Asa de móvel, com parafusos M4 para instalação |
Furniture handle with M4 screws for installation |
Tirador de mueble con tornillos M4 para instalación.
EN 1.4301 - AISI 304 Satinado | Satin

C.C.	L		
128	134	12	120
160	166	12	120

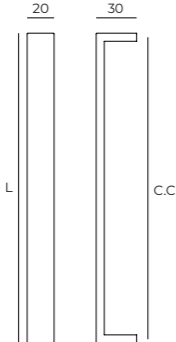





Flat 20x6

Furniture handles

IN.22.218.192 / Un.
IN.22.218.224 / Un.
IN.22.218.320 / Un.

Asa de móvel, com parafusos M4 para instalação |
Furniture handle with M4 screws for installation |
Tirador de mueble con tornillos M4 para instalación.
EN 1.4301 - AISI 304 Satinado | Satin

C.C.	L		
192	198	12	120
224	230	12	120
320	326	10	60







Off-site 10x10

Furniture handles

IN.22.208.192 / Un.
IN.22.208.224 / Un.
IN.22.208.320 / Un.
IN.22.208.512 / Un.

Asa de móvel, com parafusos M4 para instalação |
Furniture handle with M4 screws for installation |
Tirador de mueble con tornillos M4 para instalación.
EN 1.4301 - AISI 304 Satinado | Satin

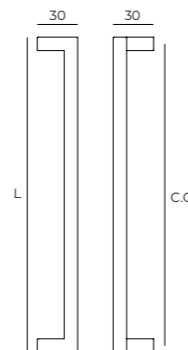
C.C.	L		
192	202	6	72
224	234	6	72
320	330	6	72
512	522	6	72







Arch spindle 10x10

Furniture handles

IN.22.214.128 / Un.
IN.22.214.160 / Un.
IN.22.214.224 / Un.
IN.22.214.320 / Un.

Asa de móvel, com parafusos M4 para instalação |
Furniture handle with M4 screws for installation |
Tirador de mueble con tornillos M4 para instalación.
EN 1.4301 - AISI 304 Satinado | Satin

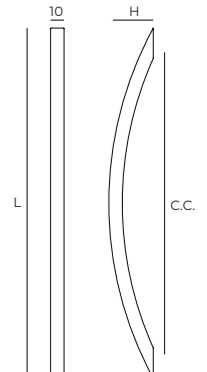
C.C.	L	H		
128	152	30	12	120
160	188	30	12	120
224	261	33	12	120
320	370	38	6	72



**CHROMIUM
FREE**



Tic-Tac Square Retractable knob

IN.22.190 / Un.

*Puxador de móvel retráctil (tic-tac) |
Retractable furniture knob (tic-tac) |
Tirador retráctil para mueble (tic-tac).*

RAL 9006 (cinzento / grey / gris)

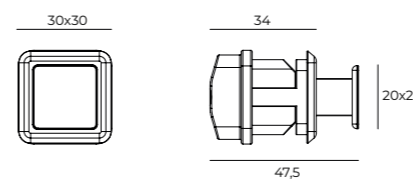

Tic-Tac Rounded Retractable knob

IN.22.191 / Un.

*Puxador de móvel retráctil (tic-tac) |
Retractable furniture knob (tic-tac) |
Tirador retráctil para mueble (tic-tac).*

RAL 9006 (cinzento / grey / gris)

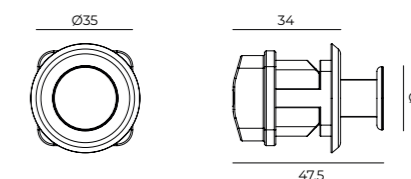



T handle Rounded $\varnothing 12$ Furniture handles

22750.128 / Un.

Asa de móvel, com parafusos M4 para instalação |
Furniture handle with M4 screws for installation |
Tirador de mueble con tornillos M4 para instalación.

RAL 9006 (cinzento / grey / gris)

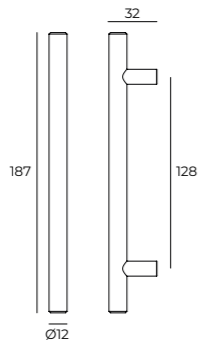

T Handle Square 12x12 Furniture handles

4599.AL.128 / Un.
4599.AL.160 / Un.
4599.AL.288 / Un.

Asa de móvel, com parafusos M4 para instalação |
Furniture handle with M4 screws for installation |
Tirador de mueble con tornillos M4 para instalación.

RAL 9006 (cinzento / grey / gris)

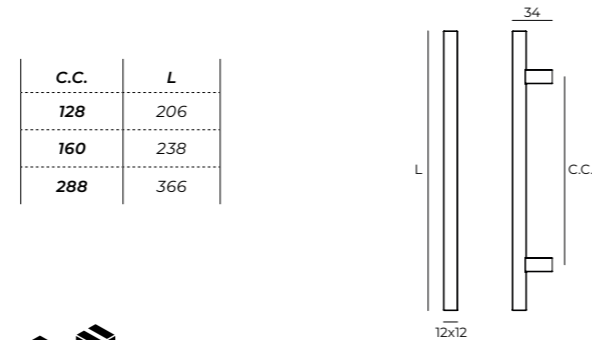

Square 28x24 Furniture handles

02906.128 / Un.

Asa de móvel, com parafusos M4 para instalação |
Furniture handle with M4 screws for installation |
Tirador de mueble con tornillos M4 para instalación.

RAL 9006 (cinzento / grey / gris)

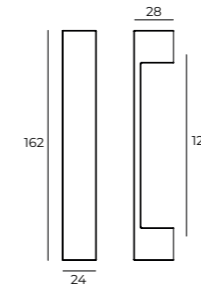

Solid Furniture handles

23258.032 / Un.
23258.064 / Un.

Asa de móvel, com parafusos M4 para instalação |
Furniture handle with M4 screws for installation |
Tirador de mueble con tornillos M4 para instalación.

RAL 9006 (cinzento / grey / gris)

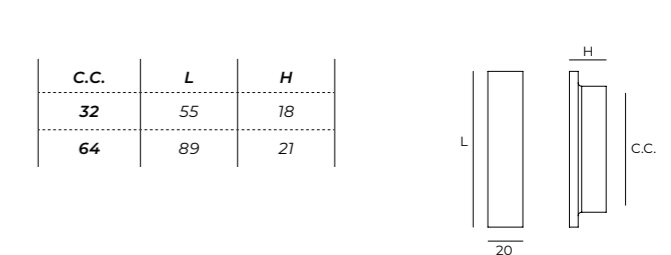



Oval flush handle

invisible fixing screws

23519.128 / Un.

Concha de embutir, com parafusos M4 para instalação /
Concealed flush handle with M4 screws for installation /
Cazoleta de embutir con tornillos M4 para instalación.

RAL 9006 (cinzento / grey / gris)

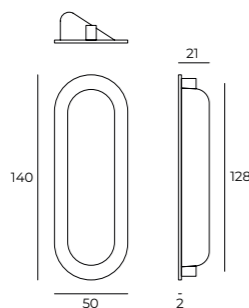

12 Un. 120 Un



T handle Rounded ø12

Furniture handles

22750.128.B / Un.

Asa de móvel, com parafusos M4 para instalação /
Furniture handle with M4 screws for installation /
Tirador de mueble con tornillos M4 para instalación.

RAL 9005 (preto / black / negro)

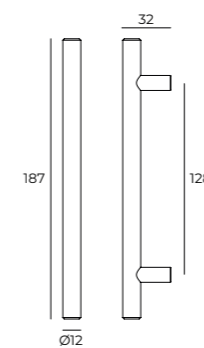

12 Un. 120 Un



Rounded flush handle

invisible fixing screws

23518.038 / Un.

Concha de embutir, com parafusos M4 para instalação /
Concealed flush handle with M4 screws for installation /
Cazoleta de embutir con tornillos M4 para instalación.

RAL 9006 (cinzento / grey / gris)

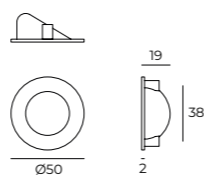

12 Un. 120 Un



T Handle Square 12x12

Furniture handles

4599.AL.128.B / Un.
4599.AL.160.B / Un.
4599.AL.288.B / Un.

Asa de móvel, com parafusos M4 para instalação /
Furniture handle with M4 screws for installation /
Tirador de mueble con tornillos M4 para instalación.

RAL 9005 (preto / black / negro)

C.C.	L
128	206
160	238
288	366

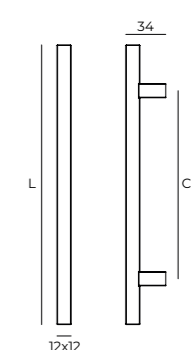

12 Un. 120 Un



Square 28x24

Furniture handles

02906.128.B / Un.

Asa de móvel, com parafusos M4 para instalação |
Furniture handle with M4 screws for installation |
Tirador de mueble con tornillos M4 para instalación.

RAL 9005 (preto / black / negro)

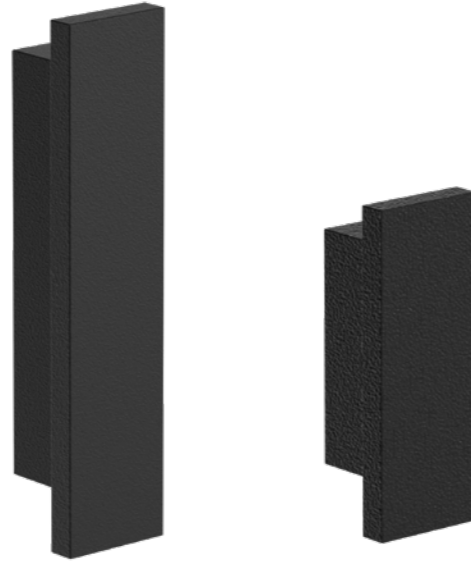
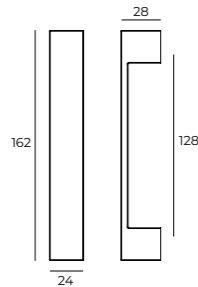

Solid

Furniture handles

23258.032.B / Un.
23258.064.B / Un.

Asa de móvel, com parafusos M4 para instalação |
Furniture handle with M4 screws for installation |
Tirador de mueble con tornillos M4 para instalación.

RAL 9005 (preto / black / negro)

C.C.	L	H
32	55	18
64	89	21

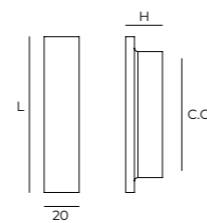

12 Un. 120 Un.



Oval flush handle

invisible fixing screws

23519.128.B / Un.

Concha de embutir, com parafusos M4 para instalação /
Concealed flush handle with M4 screws for installation /
Cazoleta de embutir con tornillos M4 para instalación.

RAL 9005 (preto / black / negro)

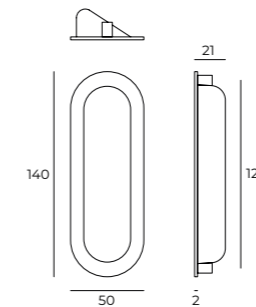

12 Un. 120 Un.



Rounded flush handle

invisible fixing screws

23518.038.B / Un.

Concha de embutir, com parafusos M4 para instalação /
Concealed flush handle with M4 screws for installation /
Cazoleta de embutir con tornillos M4 para instalación.

RAL 9005 (preto / black / negro)

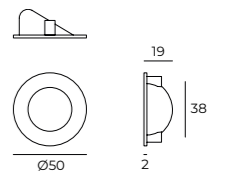

12 Un. 120 Un.



Tic-Tac Square

Retractable knob

IN.22.190.B / Un.

*Puxador de móvel retráctil (tic-tac) |
Retractable furniture knob (tic-tac) |
Tirador retráctil para mueble (tic-tac).*

RAL 9005 (preto / black / negro)

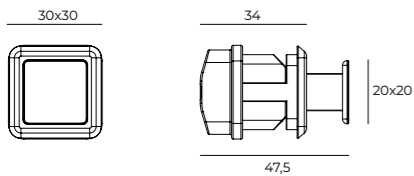

Tic-Tac Rounded

Retractable knob

IN.22.191.B Un.

*Puxador de móvel retráctil (tic-tac) |
Retractable furniture knob (tic-tac) |
Tirador retráctil para mueble (tic-tac).*

RAL 9005 (preto / black / negro)

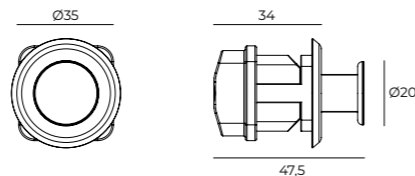

5

FERRAGENS DIVERSAS **GENERAL HARDWARE** HERRAJES DIVERSOS

5.1
BATENTE DE CHÃO /
DOOR STOPPER /
TOPE DE PUERTA

5.2
RETENTOR DE PORTA |
DOOR HOLDER |
RETENEDOR DE PUERTA.

5.3
CABIDE |
HOOK |
COLGADOR

5.4
FECHOS |
BOLTS |
PASADORES.

5.5
FECHO DE SEGURANÇA |
SECURITY LATCH |
CIERRE DE SEGURIDAD.

5.6
VISOR DE PORTA |
DOOR VIEWER |
VISOR DE PUERTA.

5.7
FECHO MAGNÉTICO |
MAGNETIC LATCH |
CIERRE MAGNETICO.

5.8
PASSA CABOS |
CABLE HOLE COVER |
PASACABLES DE EMPOTRAR.

5.9
CAIXA DE CORREIRO /
MAILBOX /
BUZÓN DE CORREO.

5.10
SUPORTE DE CORRIMÃO /
HAND RAIL SUPPORT /
SOPORTE DE PASAMANOS.

5.11
SINALÉTICA /
SIGNAGE /
SEÑALIZACION.

5.12
ACESSÓRIOS PARA CABO DE AÇO /
ACCESSORIES FOR STEEL CABLE /
ACCESORIOS PARA CABLES DE
ACERO.

5.13
SISTEMA DE SUSPENSÃO DE
MOLDURAS /
HANGING FRAMES SYSTEM /
SISTEMA DE SUSPENCIÓN DE
CUADROS

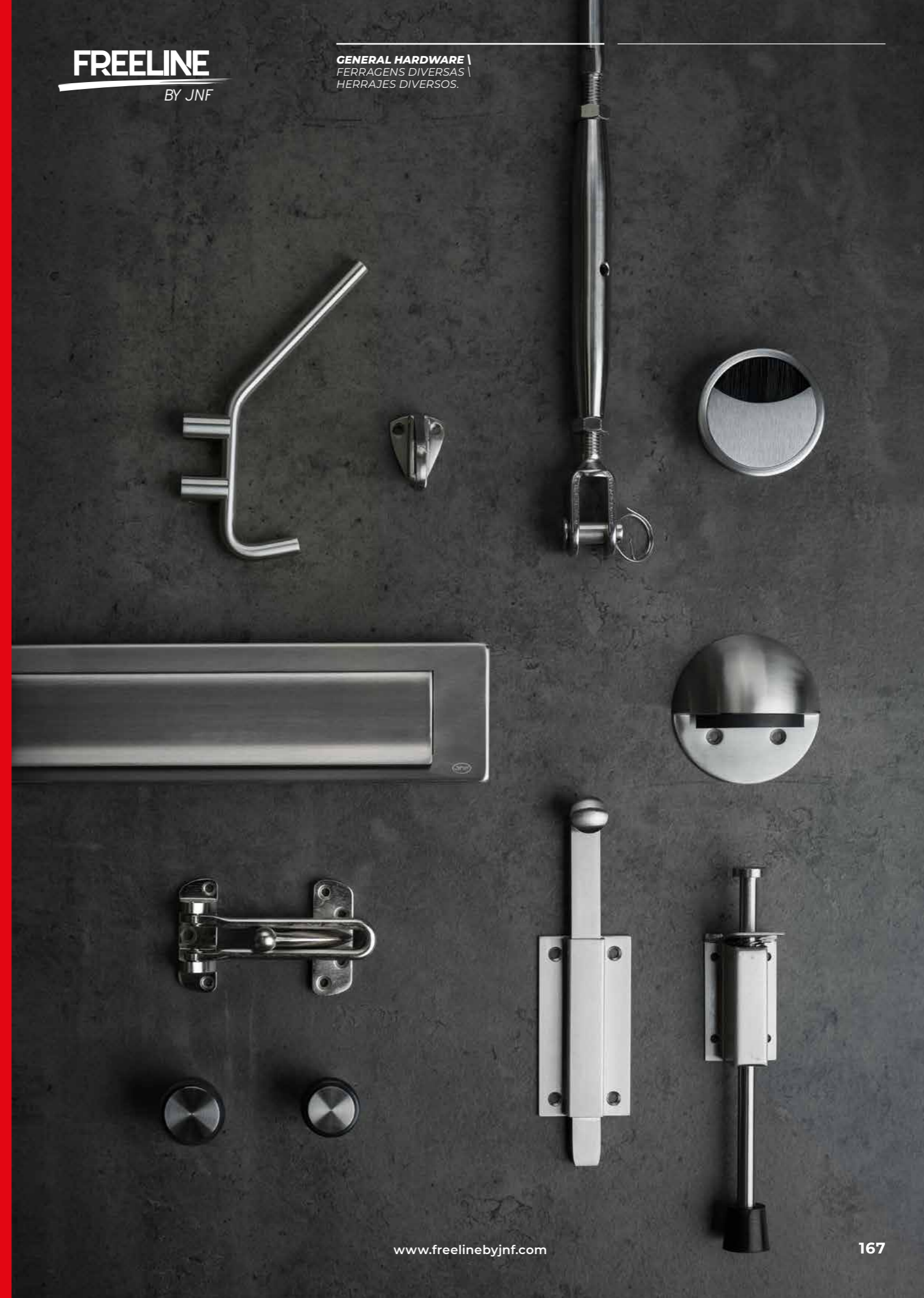



Stop ø20

Floor door stopper

IN.13.121.20 / Un.
Batente de chão | Door stopper | Tope de puerta.

EN 1.4301 - AISI 304
Satinado | Satin



Stop ø20 black

Floor door stopper

IN.13.121.20.TB / Un.
Batente de chão | Door stopper | Tope de puerta.

EN 1.4301 - AISI 304
Satinado | Satin + PVD TITANIUM Black



Stop ø20 gold

Floor door stopper

IN.13.121.20.TG / Un.
Batente de chão | Door stopper | Tope de puerta.

EN 1.4301 - AISI 304
Satinado | Satin + PVD TITANIUM Gold



Stop ø20 copper

Floor door stopper

IN.13.121.20.TCO / Un.
Batente de chão | Door stopper | Tope de puerta.

EN 1.4301 - AISI 304
Satinado | Satin + PVD TITANIUM Copper



Stop ø30

Floor door stopper

IN.13.121.30.ECO / Un.
Batente de chão | Door stopper | Tope de puerta.

EN 1.4301 - AISI 304
Satinado | Satin



Stop ø30 black

Floor door stopper

IN.13.121.30.TB / Un.
Batente de chão | Door stopper | Tope de puerta.

EN 1.4301 - AISI 304
Satinado | Satin + PVD TITANIUM Black



Stop ø30 gold

Floor door stopper

IN.13.121.30.TG / Un.
Batente de chão | Door stopper | Tope de puerta.

EN 1.4301 - AISI 304
Satinado | Satin + PVD TITANIUM Gold



Stop ø30 copper

Floor door stopper

IN.13.121.30.TCO / Un.
Batente de chão | Door stopper | Tope de puerta.

EN 1.4301 - AISI 304
Satinado | Satin + PVD TITANIUM Copper





O'ring ø20

Floor door stopper

IN.13.106.20 / Un.
Batente de chão | Door stopper | Tope de puerta.
EN 1.4301 - AISI 304 Satinado | Satin



Ergo form

Floor door stopper

IN.13.006 / Un.
Batente de chão | Door stopper | Tope de puerta.
EN 1.4301 - AISI 304 Satinado | Satin



Light Stop ø20

Floor door stopper

IN.13.121.T.20 / Un.
Batente de chão | Door stopper | Tope de puerta.
EN 1.4301 - AISI 304 Satinado | Satin



Half moon ø45

Floor door stopper

IN.13.120 / Un.
Batente de chão | Door stopper | Tope de puerta.
EN 1.4301 - AISI 304 Satinado | Satin

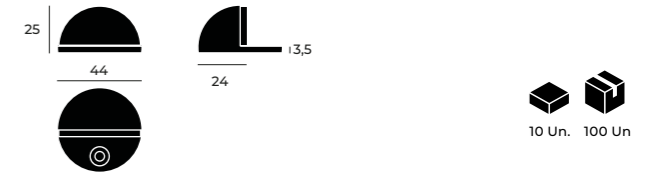

O'ring ø25

Floor door stopper

IN.13.106.25 / Un.
Batente de chão | Door stopper | Tope de puerta.
EN 1.4301 - AISI 304 Satinado | Satin



Two lines ø25

Floor door stopper

IN.13.122 / Un.
Batente de chão | Door stopper | Tope de puerta.
EN 1.4301 - AISI 304 Satinado | Satin



Quadro 19x19

Floor door stopper

IN.13.119 / Un.
Batente de chão | Door stopper | Tope de puerta.
EN 1.4301 - AISI 304 Satinado | Satin



Front man ø80

Floor door stopper

IN.13.125 / Un.
Batente de chão | Door stopper | Tope de puerta.
EN 1.4301 - AISI 304 Satinado | Satin

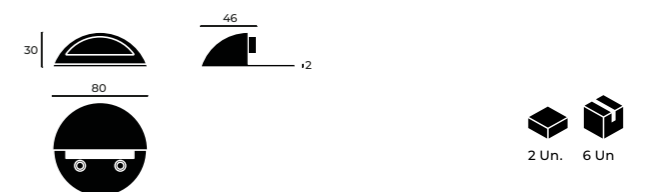



Helmet ø65

Floor door stopper

IN.13.240 / Un.
Batente de chão | Door stopper | Tope de puerta.

EN 1.4301 - AISI 304 Satinado | Satin

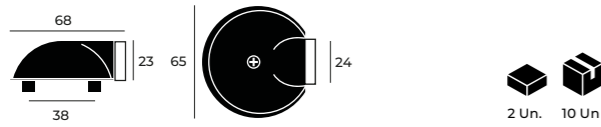

Tubular ø16

Wall door stopper

IN.13.123.CB.06 / Un.
Batente de porta para fixar na parede |
Door stopper for wall fixing | Tope de puerta para fijar en la pared.

EN 1.4301 - AISI 304 Satinado | Satin



Spring holder 265

Door holder

IN.23.127 / Un.

Retentor de porta |
Door holder | Retenedor de puerta

EN 1.4301 - AISI 304
Satinado | Satin

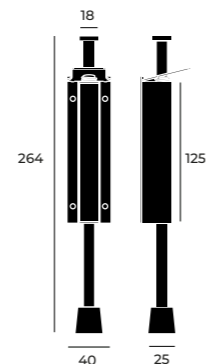

Spring holder 210

Door holder

IN.23.126 / Un.

Retentor de porta |
Door holder | Retenedor de puerta

EN 1.4301 - AISI 304
Satinado | Satin

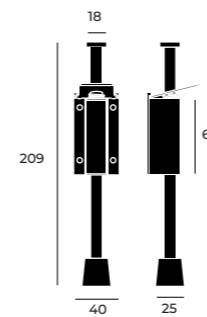

Spring holder 140

Door holder

IN.23.125 / Un.

Retentor de porta |
Door holder | Retenedor de puerta

EN 1.4301 - AISI 304
Satinado | Satin

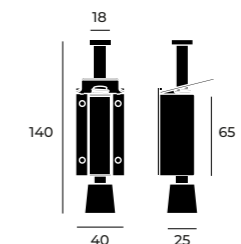

WALL AND DOOR HOOKS

CABIDES DE PAREDE E DE PORTA |
PERCHAS DE PARED Y DE PUERTA.

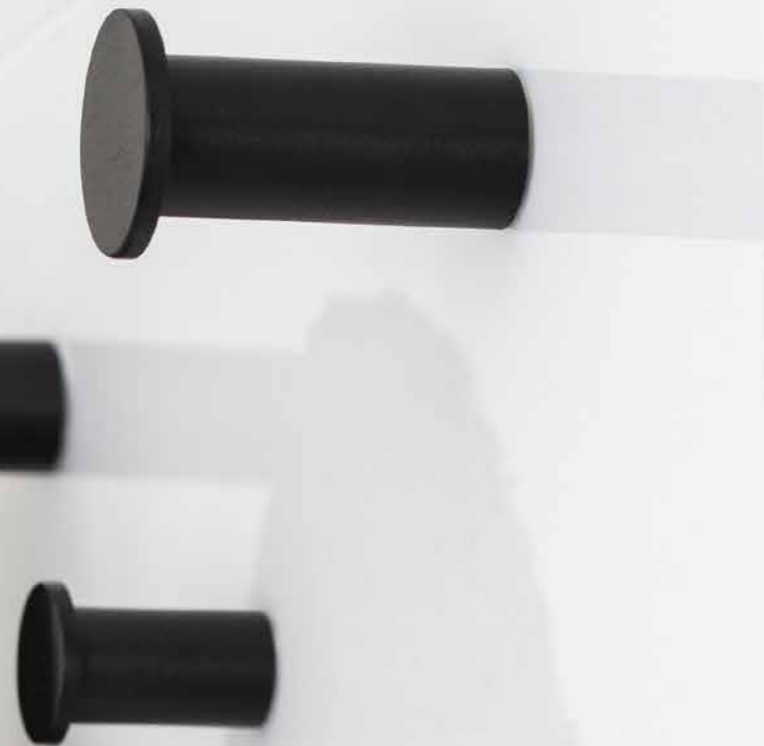

Wall dot ø30 Hook 50mm

IN.14.520.AL.SB / Un.
Cabide | Hook | Colgador.
Alumínio satinado - Preto | Satin aluminium - Black color

IN.14.520.AL.SC / Un.
Cabide | Hook | Colgador.
Alumínio satinado - Cobre | Satin aluminium - Copper color

IN.14.520.AL.SG / Un.
Cabide | Hook | Colgador.
Alumínio satinado - Dourado | Satin aluminium - Gold color

IN.14.520.AL / Un.
Cabide | Hook | Colgador.
Alumínio satinado - Cor inox | Satin aluminium - Stainless steel color

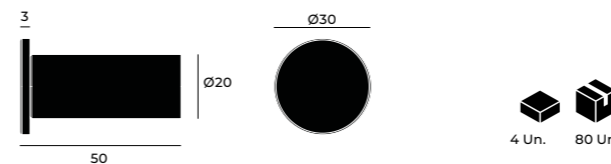

Wall dot ø22 Hook 30mm

IN.14.521.AL.SB / Un.
Cabide | Hook | Colgador.
Alumínio satinado - Preto | Satin aluminium - Black color

IN.14.521.AL.SC / Un.
Cabide | Hook | Colgador.
Alumínio satinado - Cobre | Satin aluminium - Copper color

IN.14.521.AL.SG / Un.
Cabide | Hook | Colgador.
Alumínio satinado - Dourado | Satin aluminium - Gold color

IN.14.521.AL / Un.
Cabide | Hook | Colgador.
Alumínio satinado - Cor inox | Satin aluminium - Stainless steel color

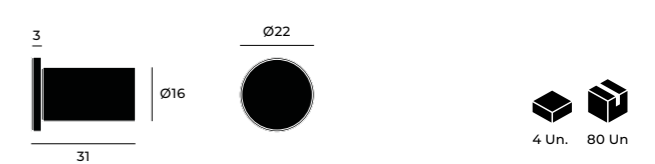



Cylinder Wall hook

IN.14.539 / Un.
Cabide duplo | Double hook | Colgador doble.
EN 1.4301 - AISI 304 Satinado | Satin

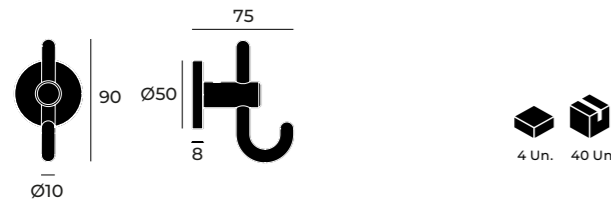

Intersection Wall hook

IN.14.537 / Un.

Cabide |
Wall hook | Colgador.

EN 1.4301 - AISI 304
Satinado | Satin

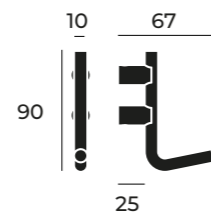

Intersection Double wall hook

IN.14.536 / Un.

Cabide duplo |
Double hook | Colgador doble.

EN 1.4301 - AISI 304
Satinado | Satin

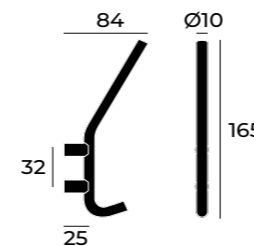

Cylinder Double wall hook

IN.14.538 / Un.

Cabide duplo |
Double hook | Colgador doble.

EN 1.4301 - AISI 304
Satinado | Satin

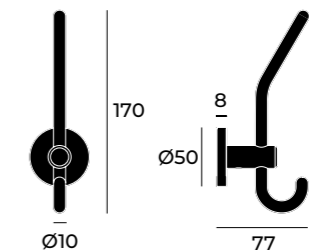

Boby guard AISI 316

IN.14.547 / Un.
Cabide com bloqueio | Hook with locking | Colgador con cierre
EN 1.4401 - AISI 316 - RAW





Flush bolt 200

With folding lever

IN.17.602 / Un.

Fecho de embutir com alavanca |
Flush bolt with folding lever |
Pasador de embutir con palanca

EN 1.4301 - AISI 304
Satinado | Satin

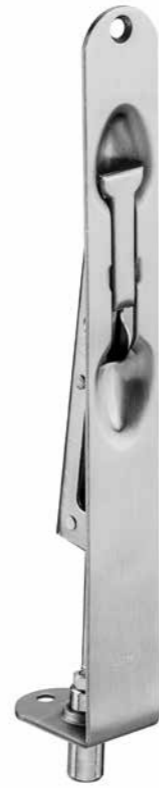
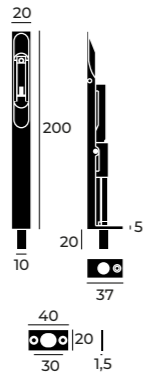

Flush bolt 200

With folding lever

IN.17.606 / Un.

Fecho de embutir com alavanca |
Flush bolt with folding lever |
Pasador de embutir con palanca

EN 1.4301 - AISI 304
Satinado | Satin

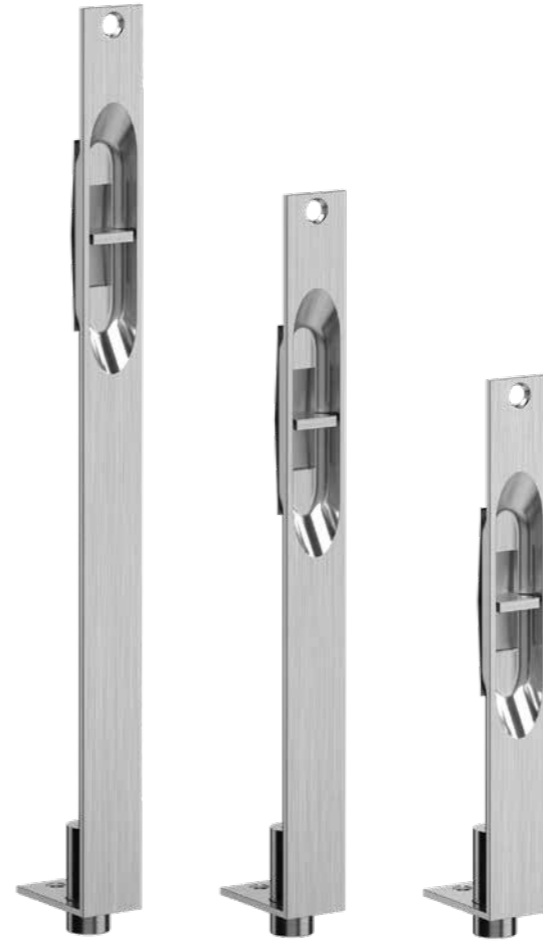
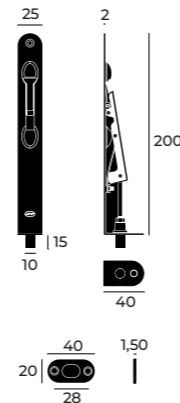

Flush bolt 250/200/150

With sliding lever

IN.17.614.250 / Un.
IN.17.614.200 / Un.
IN.17.614.150 / Un.

Fecho de embutir com alavanca
deslizante |
Flush bolt with sliding lever |
Pasador de embutir con palanca
deslizante.

EN 1.4301 - AISI 304
Satinado | Satin

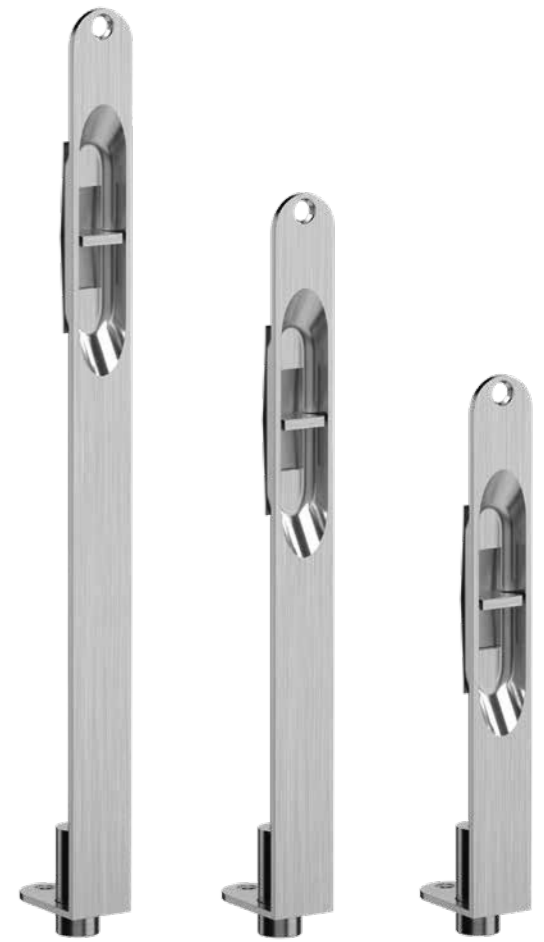
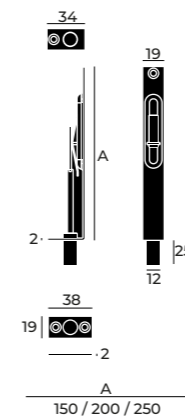

Flush bolt 250/200/150

With sliding lever

IN.17.615.250 / Un.
IN.17.615.200 / Un.
IN.17.615.150 / Un.

Fecho de embutir com alavanca
deslizante |
Flush bolt with sliding lever |
Pasador de embutir con palanca
deslizante.

EN 1.4301 - AISI 304
Satinado | Satin

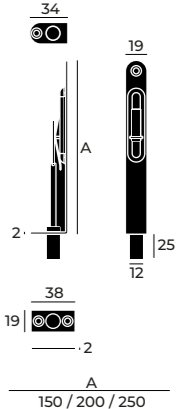



Flush bolt profile

With folding lever

IN.17.618 / Un.

*Fecho de embutir
com alavanca para perfis |
Flush bolt with folding lever
for profiles |
Pasador de embutir con
palanca para perfiles*

EN 1.4301 - AISI 304
Satinado | Satin

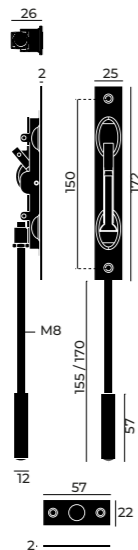

Square barrel bolt 500

surface mounting

IN.17.603.500 / Un.

*Fecho de sobrepor |
Barrel bolt surface mounting |
Pasador de sobreponer*

EN 1.4301 - AISI 304
Satinado | Satin

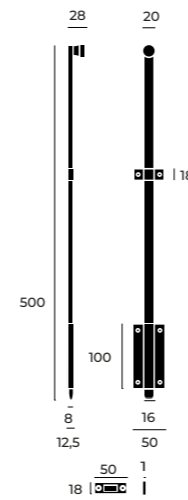

Square barrel bolt 400

surface mounting

IN.17.603.400 / Un.

*Fecho de sobrepor |
Barrel bolt surface mounting |
Pasador de sobreponer*

EN 1.4301 - AISI 304
Satinado | Satin

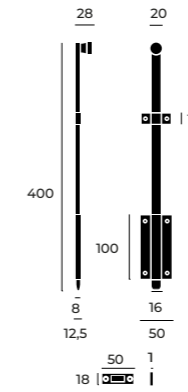

Square barrel bolt 200

surface mounting

IN.17.603.200 / Un.

*Fecho de sobrepor |
Barrel bolt surface mounting |
Pasador de sobreponer*

EN 1.4301 - AISI 304
Satinado | Satin

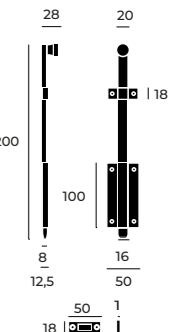



Barrel bolt / folding lever

50 / 100 / 150 / 200

IN.17.610.50 / Un.
IN.17.610.100 / Un.
IN.17.610.150 / Un.
IN.17.610.200 / Un.

Fecho de culatra de sobrepór |
Surface mounting barrel bolt
with folding lever |
Pasador de sobrepór con
palanca plegable.

EN 1.4301 - AISI 304
Satinado | Satin

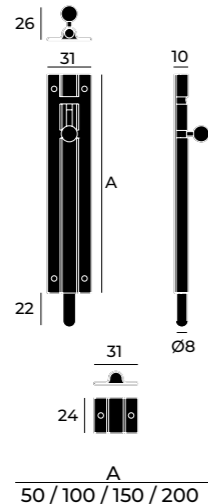

Barrel bolt / folding lever

90 / 115 / 165

IN.17.609.90 / Un.
IN.17.609.115 / Un.
IN.17.609.165 / Un.

Fecho de culatra de sobrepór |
Surface mounting barrel bolt
with folding lever |
Pasador de sobrepór con
palanca plegable.

EN 1.4301 - AISI 304
Satinado | Satin

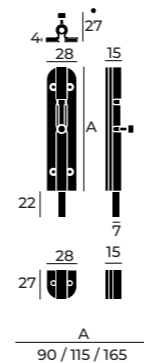

Barrel bolt / folding lever

150 / 200 / 250

IN.17.611.150 / Un.
IN.17.611.200 / Un.
IN.17.611.250 / Un.

Fecho de culatra de sobrepór |
Surface mounting barrel bolt
with folding lever |
Pasador de sobrepór con
palanca plegable.

EN 1.4301 - AISI 304
Satinado | Satin

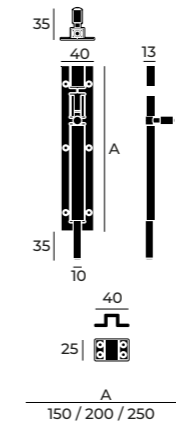

Sliding door latch

With turning lever

IN.17.619 / Un.

Fecho para porta de correr |
Sliding door latch |
Cierre para puertas correderas.

EN 1.4301 - AISI 304
Satinado | Satin

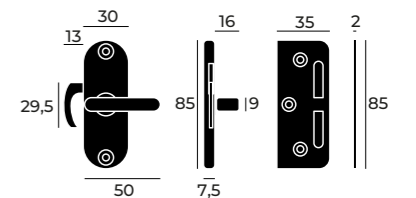



Snib indicator bolt With sliding lever

IN.17.616 / Un.

Fecho com indicador de cor |
Slide bolt with color indicator |
Cierre con indicador de color.

EN 1.4301 - AISI 304
Satinado | Satin

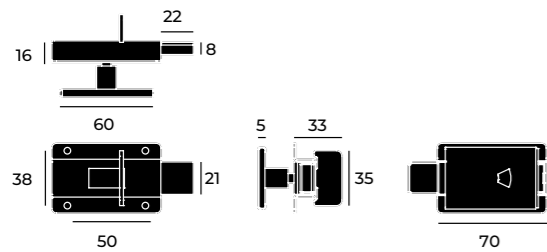

Bolt with sliding lever Surface mounting

IN.17.617 / Un.

Fecho de sobrepor com alavanca deslizante |
Surface mounting bolt with sliding lever |
Pasador de sobrepor con leva deslizante.

EN 1.4301 - AISI 304
Satinado | Satin

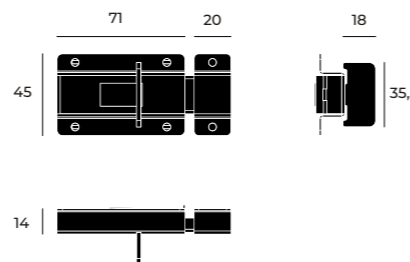

Padlock Hasp Heavy duty

IN.17.621 / Un.

Fecho para cadeado |
Hasp for padlock |
Cierre para candado.

EN 1.4301 - AISI 304
Satinado | Satin

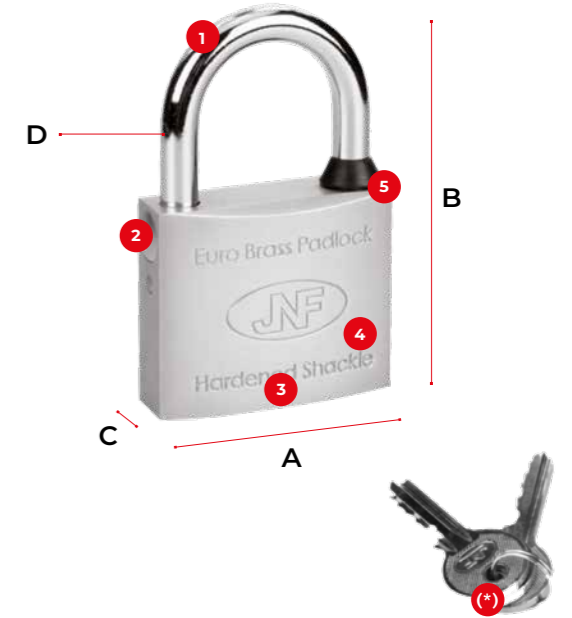
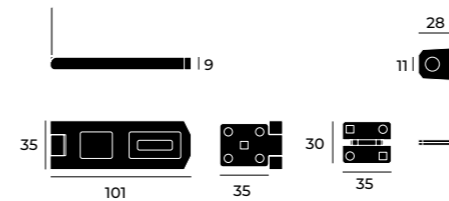

Padlock Hardened shackle

1983.25.CM.1 / Un.
1983.30.CM.1 / Un.
1983.40.CM.1 / Un.
1983.50.CM.1 / Un.
1983.60.CM.1 / Un.

Cadeado | Padlock | Candado.



REF	A	B	C	D
1983.25.CM.1	25	43	12	4
1983.30.CM.1	30	51	13	5
1983.40.CM.1	40	64	15	6
1983.50.CM.1	50	80	17	8
1983.60.CM.1	60	93	19	9,5

1. Arco em aço temperado cromado /
Hardened chrome plated steel shackle / Arco en acero endurecido y cromado
2. Duplo fecho em latão com mola em aço inoxidável / Double brass bolt with stainless steel spring / Cerrajo doble en latón con resort en acero inoxidable
3. Cilindro, pinos e cravos em latão / Brass plug, pin and driver / Cilindro, clavijas y pernos en latón
4. Corpo em latão com acabamento cromado mate (anti-corrosão) / Brass body with Mattee chrome finish (anti-corrosion) / Cuerpo de latón con acabado cromado mate (anticorrosión)
5. Anilha de borracha que protege o mecanismo interior / Rubber ring to protect the inside mechanism / Anillo de goma, protege el mecanismo interior

(*) Fornecido com duas chaves / Supplied with two keys / Suministrado con duas llaves.



Hotel security chain Concealed

IN.17.202 / Un.

Corrente de segurança, limitador de abertura de porta com indicação de fecho | Security chain door opening limiter with lock indicator | Cadena de seguridad, limitador de apertura de puerta con indicación de cierre.

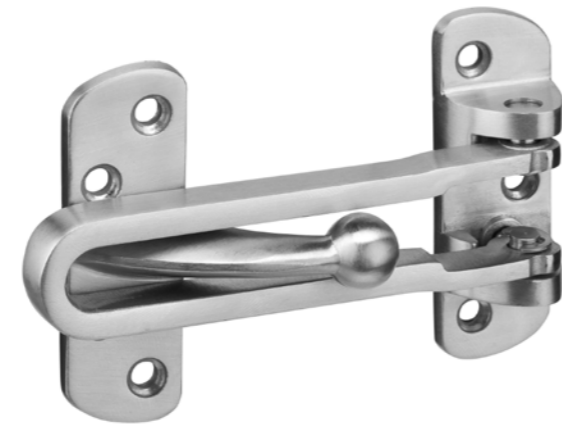
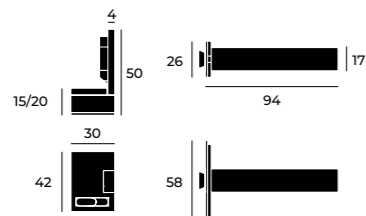

Hotel security latch Surface mounting

IN.17.200 / Un.

Fecho limitador de abertura de porta | Door opening limiter latch | Limitador de apertura de puerta.



Door viewer 180° 35 - 55 thickness

IN.23.012.NS / Un.

Visor de porta com ângulo de visão 180°. Ajustável a espessura de porta de 35 a 55mm | Door viewer with 180° viewing angle. Adjustable door thickness from 35 to 55mm | Visor de puerta con ángulo de visión de 180°. Espesor de puerta ajustable de 35 a 55mm.

Latão níquel satinado | Satin nickel brass | Latón níquel satin

IN.23.012.NS.B / Un. **NOVO / NEW / NUEVO**

Visor de porta com ângulo de visão 180°. Ajustável a espessura de porta de 35 a 55mm | Door viewer with 180° viewing angle. Adjustable door thickness from 35 to 55mm | Visor de puerta con ángulo de visión de 180°. Espesor de puerta ajustable de 35 a 55mm.

Latão + RAL 9005 | Nickel brass + RAL 9005 | Latón + RAL 9005

IN.23.012.ZN / Un.

Visor de porta com ângulo de visão 180°. Ajustável a espessura de porta de 35 a 55mm | Door viewer with 180° viewing angle. Adjustable door thickness from 35 to 55mm | Visor de puerta con ángulo de visión de 180°. Espesor de puerta ajustable de 35 a 55mm.

Zamak níquel satinado | Satin nickel zamak | Zamak níquel satin



Door viewer 180° Brass - Adjustable

03501.25.42.CM / Un.

Visor de porta com ângulo de visão 180°. Ajustável a espessura de porta de 25 a 42mm | Door viewer with 180° viewing angle. Adjustable door thickness from 25 to 42mm | Visor de puerta con ángulo de visión de 180°. Espesor de puerta ajustable de 25 a 42mm.

Latão cromado mate | Matte chrome brass | Latón cromado mate

03501.35.50.LP / Un.

Visor de porta com ângulo de visão 180°. Ajustável a espessura de porta de 35 a 55mm | Door viewer with 180° viewing angle. Adjustable door thickness from 35 to 55mm | Visor de puerta con ángulo de visión de 180°. Espesor de puerta ajustable de 35 a 55mm.

Latão polido | Polished brass | Latón pulido

03501.50.75.LP / Un.

Visor de porta com ângulo de visão 180°. Ajustável a espessura de porta de 50 a 75mm | Door viewer with 180° viewing angle. Adjustable door thickness from 50 to 75mm | Visor de puerta con ángulo de visión de 180°. Espesor de puerta ajustable de 50 a 75mm.

Latão polido | Polished brass | Latón pulido



IN.17.020
TIC TAC MAGNETIC



IN.17.021
TIC TAC



Tic tac

Push open system

IN.17.020 / Un.



10 Un. 200 Un.

Fecho tic tac magnético ajustável |
Adjustable magnetic push open |
Cierre tic tac magnético ajustable.

EN 1.4301 - AISI 304
Satinado | Satin

IN.17.021 / Un.



10 Un. 200 Un.

Fecho tic tac ajustável |
Adjustable push open | Cierre tic tac ajustable.

EN 1.4301 - AISI 304
Satinado | Satin

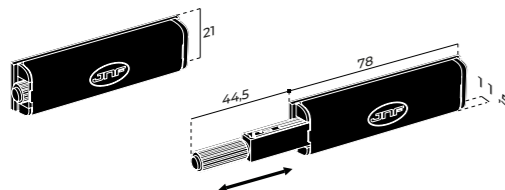

IN.17.022
8 kg



IN.17.023
10 kg



Magnetic catch

Stainless steel

IN.17.022 / Un.



10 Un. 240 Un.

Fecho magnético. Força magnética: 8kg |
Magnetic latch. Magnetic power: 8kg |
Cierre magnético. Fuerza magnética: 8kg.

EN 1.4301 - AISI 304
Satinado | Satin

IN.17.023 / Un.



10 Un. 180 Un.

Fecho magnético. força magnética: 10 kg |
Magnetic latch Magnetic power: 10 kg |
Cierre magnético. Fuerza magnética: 10kg.

EN 1.4301 - AISI 304
Satinado | Satin

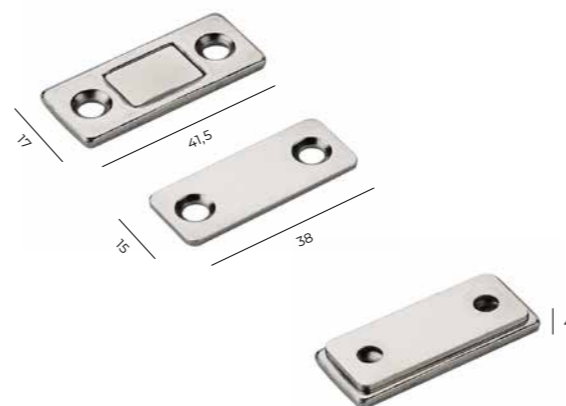

Flat magnet

Magnetic door holder

IN.17.024 / Un.



10 Un. 100 Un.

Fecho magnético | retentor de porta de armário magnético. Instalação por parafusos ou adesivo 3M (incluídos). Força magnética: 8kg |

Door magnetic latch | retainer for furniture.
Installation by screws or 3M double face adhesive.
(included) Magnetic power: 8kg |

Cierre | retentor magnético de puerta de armario.
Instalación por tornillos o adhesivo 3M (incluidos).
Fuerza magnética: 8kg.



Ball catcher

Power adjustable

IN.17.011 / Un.



10 Un. 100 Un.

Retentor de porta com esfera. força e curso ajustável |
Door ball catcher
Power and course adjustable |
Retenedor de puerta con bola.
fuerza y recorrido ajustable.

EN 1.4301 - AISI 304
Satinado | Satin

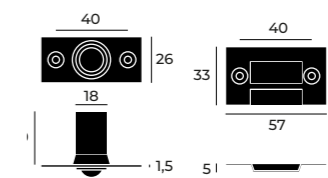

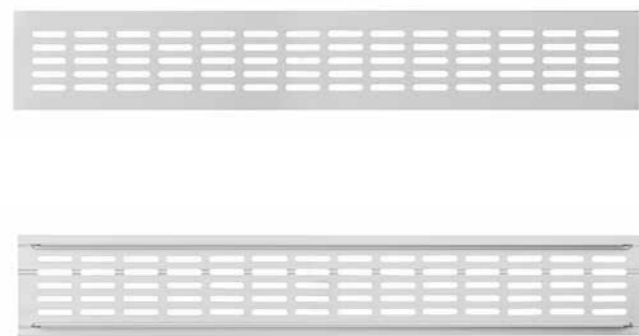

new

Ventilation grill 300mm

3029.300.AN / Un.

Grelha de ventilação 300mm |
Ventilation grill 300mm |
Rejilla de ventilación 300mm.

Alumínio | Aluminium

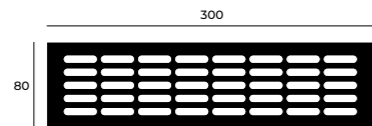

new

Ventilation grill 500mm

3029.500.AN / Un.

Grelha de ventilação 500mm |
Ventilation grill 500mm |
Rejilla de ventilación 500mm

Alumínio | Aluminium

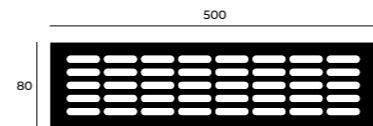

IN.22.140.60
ø60mm



IN.22.140.80
ø80mm



IN.22.140.60.B
ø60mm



IN.22.140.80.B
ø80mm



Cable hole cover Stainless steel color

IN.22.140.60 / Un.
IN.22.140.80 / Un.

Passa cabos em alumínio de embutir |
Flush-mounted aluminium cable hole cover |
Pasacables en Aluminio de empotrar.

Alumínio - cor inox |
Aluminium - stainless steel color |
Aluminio - color acero inoxidable.

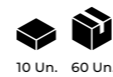
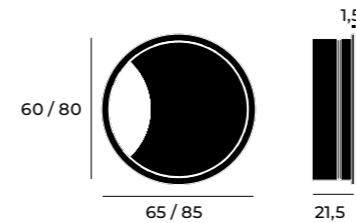

Cable hole cover Black matte color

IN.22.140.60.B / Un.
IN.22.140.80.B / Un.

Passa cabos em alumínio de embutir |
Flush-mounted aluminium cable hole cover |
Pasacables en Aluminio de empotrar.

Alumínio - preto mate |
Aluminium - black matte |
Aluminio - Negro mate.

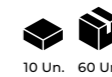
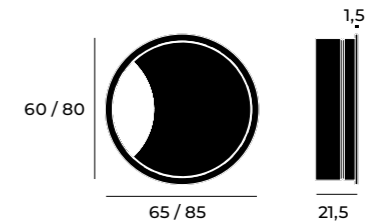



372



Mail to me Letter plate

IN.24.542 / Un.

Frente de correio /
Letter plate /
Frente de correo

EN 1.4301 - AISI 304
Satinado / Satin

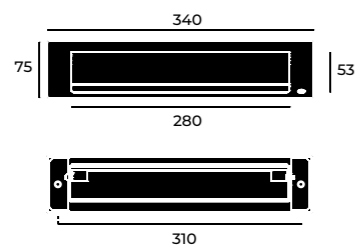

5 Un. 30 Un.



Mail box back door

IN.24.545 / Un.

Caixa de correio, pode ser instalada no exterior. Abertura frontal para entrada de correio com tampa de protecção de chuva. Porta traseira para saída do correio com fechadura /

Mailbox possible to apply outside. Front opening for incoming mail with a protective cap for rain. Back door with lock to take out the mail /

Buzón de correo posible aplicar en el exterior. Apertura frontal para el correo con una tapa protectora de la lluvia. Puerta de correo con cerradura.

EN13724 1341

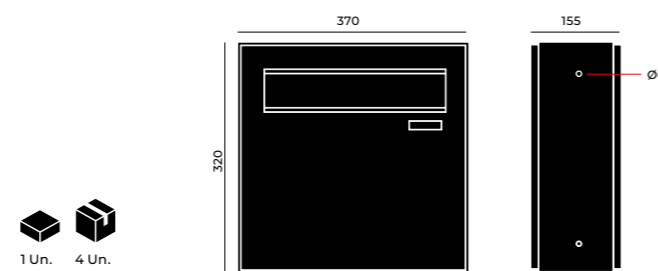

1 Un. 4 Un.

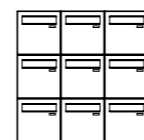

Mail box front door

IN.24.544 / Un.

Caixa de correio com fixação à parede. Pode ser instalada no exterior. Abertura frontal para entrada de correio com tampa de protecção de chuva. Porta frontal para saída do correio com fechadura. 2 chaves /

Mailbox with wall fixing. Possible to apply outside. Front opening for incoming mail with a protective cap for rain. Front door with lock to take out the mail. 2 keys /

Buzón de correo con sujecion de pared. Posible aplicar en el exterior. Apertura frontal para el correo con una tapa protectora de la lluvia. Puerta de salida de correo con cerradura. 2 llaves.

EN13724 1341

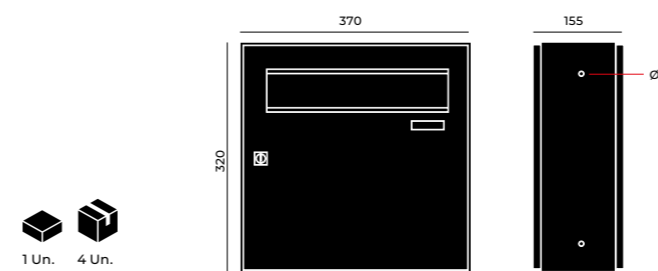

1 Un. 4 Un.



Mail box Exterior



CC.24.561 / Un.

Caixa de correio com fixação à parede. Pode ser instalada no exterior. Comporta formatos de correio A4. Abertura frontal para entrada de correio com tampa de protecção de chuva. Porta frontal para saída do correio com fechadura. Caixa de correio feita em aço galvanizado com acabamento em cinzento metalizado com tratamento anti-corrosivo. Inclui duas chaves | Mailbox with wall fixing. It can be installed outdoors. Supports A4 mail formats. Front opening for mail entry with rain protection cover. Front door for mail output with lock. Mailbox made of galvanized steel with a metallic gray finish with anti-corrosive treatment. Includes two keys | Buzón de pared. Se puede instalar en exteriores. Admite formatos de correo A4. Apertura frontal para entrada de correo con cubierta de protección contra la lluvia. Puerta frontal para salida de correo con cerradura. Buzón fabricado en acero galvanizado acabado gris metalizado con tratamiento anticorrosivo. Incluye dos llaves.



1 Un. 4 Un.



Hand rail support

Tubular - Wall fixing

IN.18.130 / Un.

Suporte de corrimão de fixação à
parede com parafusos ocultos /
Hand rail support for wall fixing
with hidden screws /
Soporte de pasamanos para pared
con tornillos ocultos.

EN 1.4301 - AISI 304
Satinado | Satin

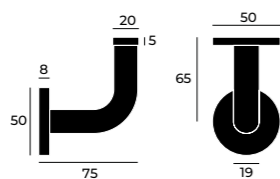

Hand rail support

Angle - Wall fixing

IN.18.131 / Un.

Suporte de corrimão de fixação à
parede com parafusos ocultos /
Hand rail support for wall fixing
with hidden screws /
Soporte de pasamanos para
pared con tornillos ocultos.

EN 1.4301 - AISI 304
Satinado | Satin



IMAGEM / IMAGE / IMAGEN:
IN.34.003.PF.0

Avantgard numbers

with shadow

IN.34.003.PF._ / Un.

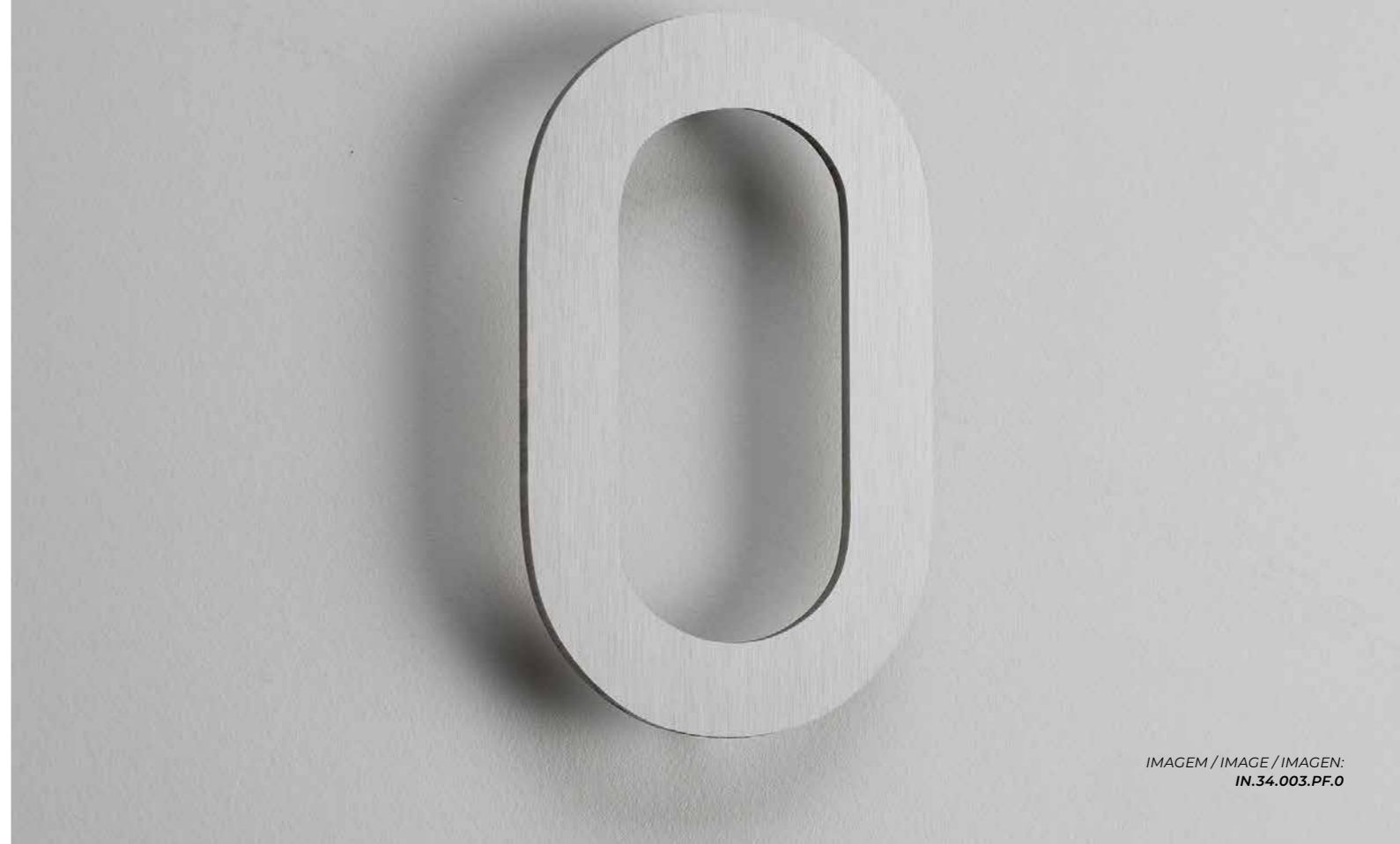
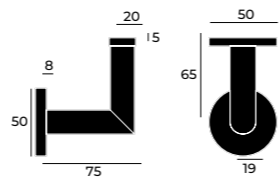
Algarismos com fixação oculta por parafusos à parede /
Numerals with concealed fixing through wall screws /
Algarismos con sujeción oculta por tornillo.

EN 1.4301 - AISI 304
Satinado | Satin

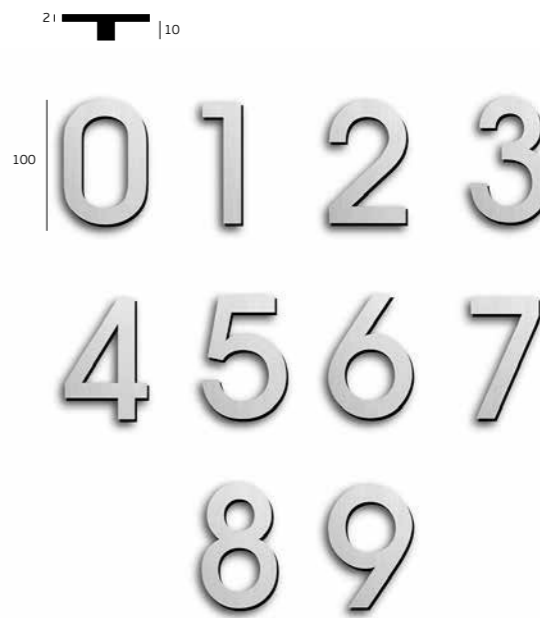
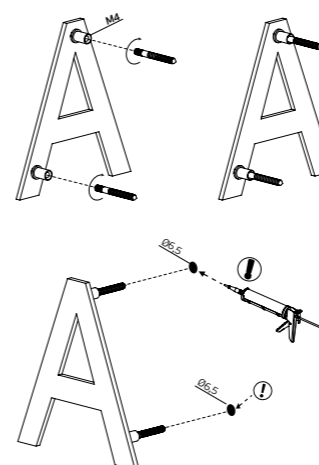

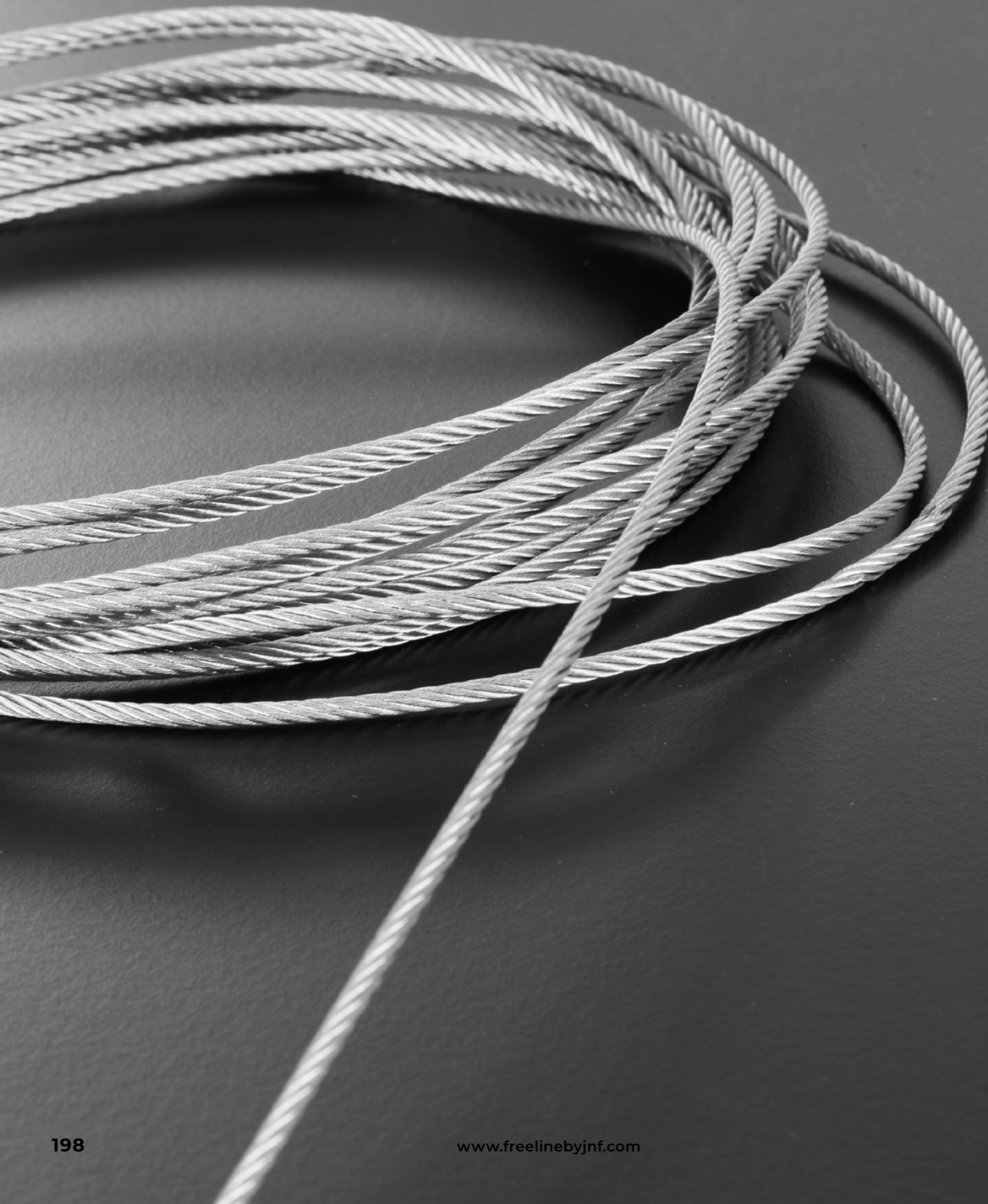

Wire rope AISI 316

IN.10.202 / Un.
IN.10.203 / Un.
IN.10.204 / Un.
IN.10.206 / Un.
IN.10.208 / Un.



Cabo de aço inoxidável 7x19 |
Stainless steel wire rope 7x19 |
Cable de acero inoxidable 7x19.

EN 1.4401 - AISI 316

REF	Ø Cable	MÁX CARGA LOAD	MEDIDA SIZE
IN.10.202	2,5	373 kg	100m 
IN.10.203	3	571 kg	
IN.10.204	4	900 kg	
IN.10.206	6	1900 kg	
IN.10.208	8	3500 kg	

Wire rope set + Accessories

IN.10.100.3 / Un.
IN.10.100.4 / Un.
IN.10.100.6 / Un.
IN.10.100.8 / Un.



Kit completo com cabo de aço inoxidável 7x19, esticador, terminal e dois olhais | Complete set with stainless steel wire rope 7x19, turnbuckle, fast and safe terminal and two eye bolts | Juego completo con cable de acero inoxidable 7x19, tensor, terminal e dos tornillos.

EN 1.4401 - AISI 316

REF	Ø Cable	MÁX CARGA / LOAD	MEDIDA SIZE
IN.10.100.3	3	400 kg	5M
IN.10.100.4	4	630 kg	10M
IN.10.100.6	6	1330 kg	15M
IN.10.100.8	8	2450 kg	25M 50M



Rigging screw jaw-jaw

IN.10.211 / Un.
IN.10.311 / Un.
IN.10.011 / Un.
IN.10.411 / Un.
IN.10.611 / Un.
IN.10.811 / Un.



Esticador "forqueta-forqueta" em aço inoxidável AISI 316 |
Rigging screw "jaw-jaw" made in stainless steel AISI 316 |
Tensor cerrado "horquilla-horquilla" en acero inoxidable AISI 316.
EN 1.4401 - AISI 316

REF	Ø Cable	MÁX LOAD	METRIC	A mm	B mm	C mm
IN.10.211	2,5	260 kg	M5	125 - 190	7,5	5
IN.10.311	3	400 kg	M6	145 - 220	8,5	6
IN.10.011	4	630 kg	M8	165 - 250	10,5	8
IN.10.411	4	630 kg	M10	195 - 290	12	9
IN.10.611	6	1330 kg	M12	240 - 355	12,5	12
IN.10.811	8	2450 kg	M16	320 - 470	16,5	16

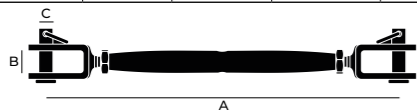

Fork terminal External thread

IN.10.231 / Un.
IN.10.031 / Un.
IN.10.431 / Un.
IN.10.631 / Un.
IN.10.831 / Un.



Terminal com forquilha com rosca métrica exterior em aço inoxidável AISI 316 | Fork terminal with metrical external thread made in stainless steel AISI 316 | Termina con horquilla y hilo métrico exterior en acero inoxidable AISI 316.
EN 1.4401 - AISI 316

REF	Ø Cable	MÁX LOAD	METRIC	A mm	B mm	C mm	D mm
IN.10.231	2,5 / 3	260 kg	M6	74	7,5	6	47
IN.10.031	4	630 kg	M8	81	10	8	56
IN.10.431	4	630 kg	M10	94	12	9	69
IN.10.631	6	1330 kg	M12	118	12,5	12	78
IN.10.831	8	2450 kg	M16	153	18	16	104

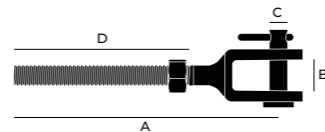

Swageless fork Fast and easy installation

IN.10.320 / Un.
IN.10.020 / Un.
IN.10.620 / Un.
IN.10.820 / Un.



Terminal forquilha para cabo de aço inoxidável com sistema de aperto fácil, permite a instalação sem recurso a ferramentas de estampagem / Swageless fork terminal for stainless steel cable with easy clamping system, allows installation without use of stamping tools / Terminal de horquilla para cable de acero inoxidable con sistema de sujeción fácil, permite la instalación sin el uso de herramientas de estampado.
EN 1.4401 - AISI 316

REF	Ø Cable	MÁX LOAD	METRIC	A mm	B mm	C mm
IN.10.320	3	260 kg	M10	49	7	5
IN.10.020	4	630 kg	M12	59	8	8
IN.10.620	6	1330 kg	M16	76	12	9
IN.10.820	8	2450 kg	M16	85	12	12,5

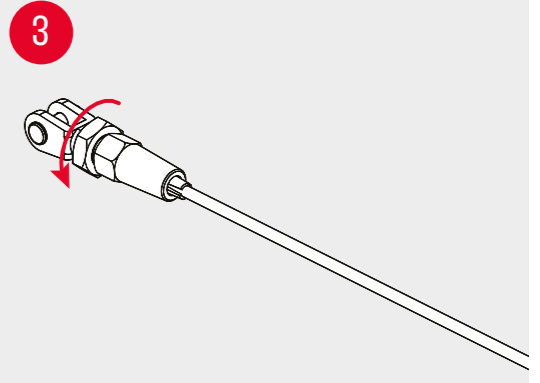
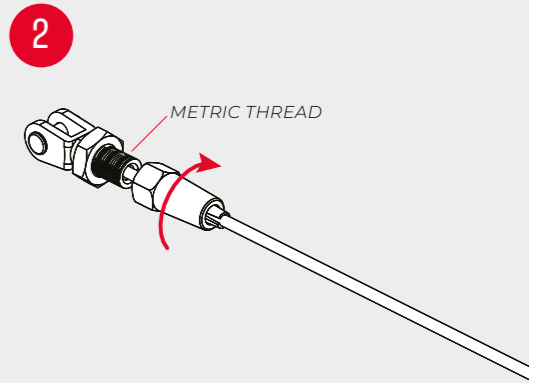
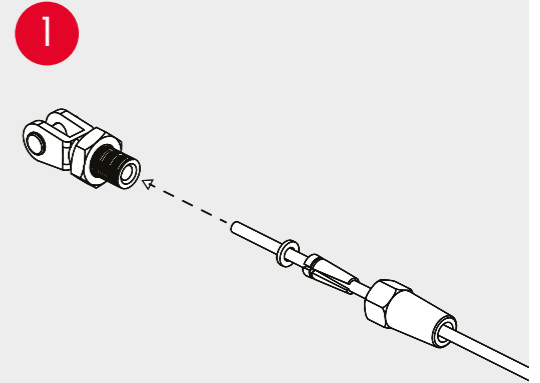
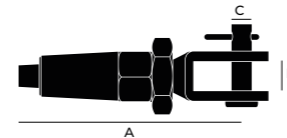

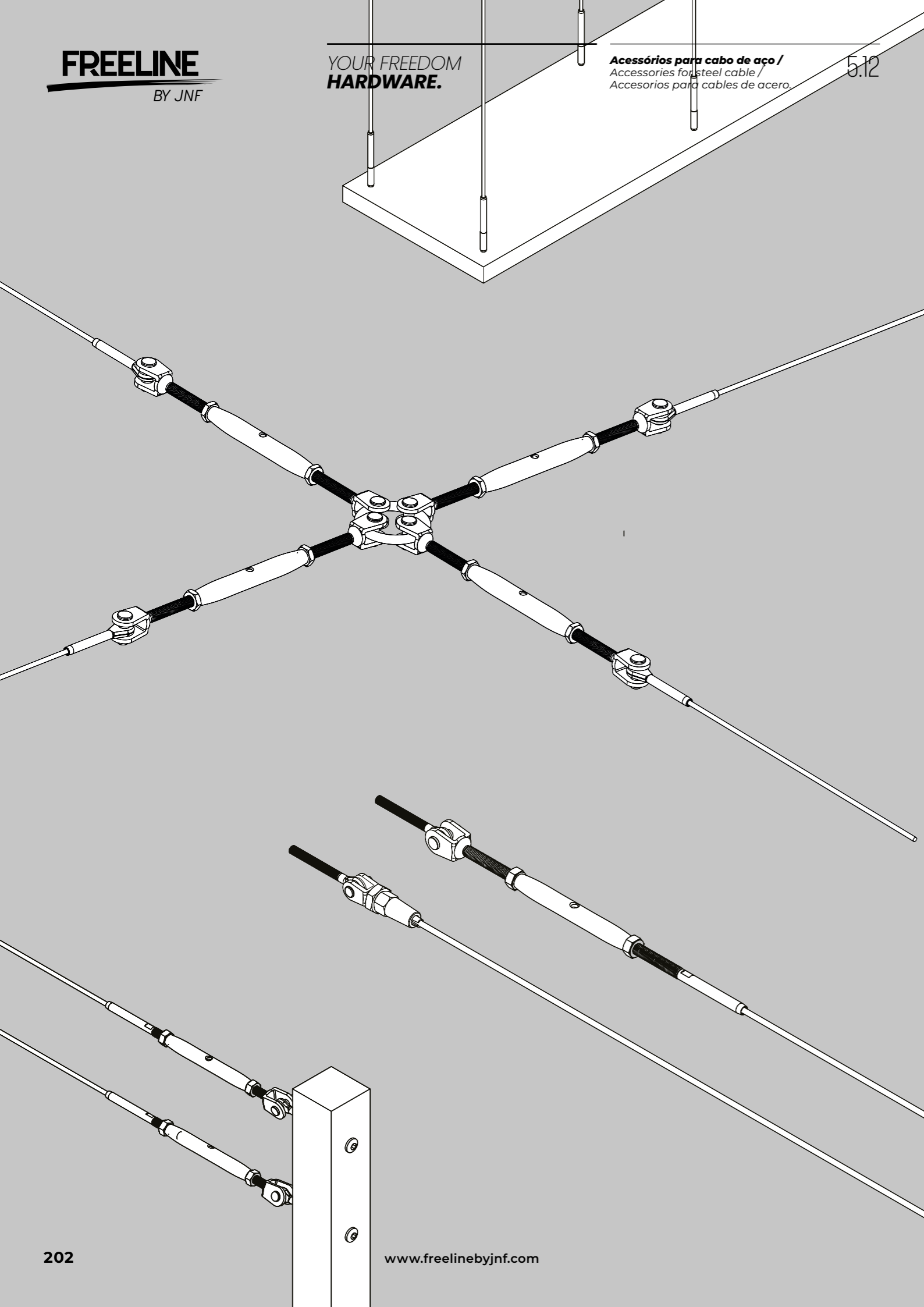

**Esticador com
cabo aplicado /**
Turnbuckle with
cable installed /
Tensor con
cable aplicado.
IN.10....C + X
(Comprimento de cabo
Cable length /
Largo de cable)

Rigging screw jaw-wire rope terminal

IN.10.210 / Un.
IN.10.310 / Un.
IN.10.010 / Un.
IN.10.610 / Un.
IN.10.810 / Un.



*Esticador forqueta-terminal para cravar cabo de aço |
Rigging screw jaw-wire rope terminal to stamp wire rope |
Tensor cerrado horquilla-terminal para cravar cable de acero.*

EN 1.4401 - AISI 316

REF	Ø Cable	MÁX LOAD	METRIC	A mm	B mm	C mm	D mm
IN.10.210	2,5	260 kg	M5	155 - 220	7,5	5	26
IN.10.310	3	400 kg	M6	170 - 245	8,5	6	40
IN.10.010	4	630 kg	M8	180 - 255	8,5	6	45
IN.10.610	6	1330 kg	M12	290 - 415	14,5	12	65
IN.10.810	8	2450 kg	M16	360 - 610	22,5	14	84

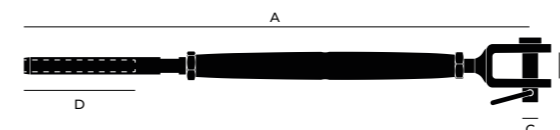

**Terminal com
cabo aplicado /**
Terminal with
cable installed /
Terminal con
cable aplicado.
IN.10....C + X
(Comprimento de cabo
Cable length /
Largo de cable)

Swage stud terminal metric with nut

IN.10.232 / Un.
IN.10.332 / Un.
IN.10.432 / Un.
IN.10.632 / Un.
IN.10.832 / Un.



*Terminal para cravar cabo de aço com rosca métrica exterior
e contraporca de bloqueio | Terminal to stamp wire rope with
extered metric thread and locking nut | Terminal para cravar
cable de acero con hilo metrico exterior y tuerca de bloqueio.*

EN 1.4401 - AISI 316

REF	Ø Cable	MÁX LOAD	METRIC	A mm	B mm	C mm
IN.10.232	2,5	260 kg	M5	88	42	35
IN.10.332	3	400 kg	M6	100	45	43
IN.10.432	4	630 kg	M8	105	45	45
IN.10.632	6	1330 kg	M10	145	62	65
IN.10.832	8	2450 kg	M16	200	98	80

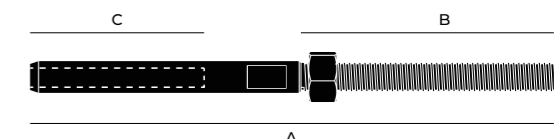



Terminal com
cabo aplicado /
Terminal with
cable installed /
Terminal con
cable aplicado.
IN.10.---.C + X
(Comprimento de cabo
Cable length /
Largo de cable)

Swage stud terminal with internal thread

IN.10.234 / Un.
IN.10.334 / Un.
IN.10.434 / Un.
IN.10.634 / Un.
IN.10.834 / Un.



Terminal para cravar cabo de aço com rosca métrica interior /
Terminal to stamp wire rope with interior metric thread /
Terminal para cravar cable de acero con hilo métrico interior.

REF	Ø Cable	MÁX LOAD	A mm	B	C mm	D mm	E Ømm
IN.10.234	2,5	260 kg	64	M4	32	24	5,5
IN.10.334	3	400 kg	77	M5	37	28	7
IN.10.434	4	630 kg	83	M5	45	30	8
IN.10.634	6	1330 kg	110	M8	65	40	12,5
IN.10.834	8	2450 kg	107	M10	60	45	16

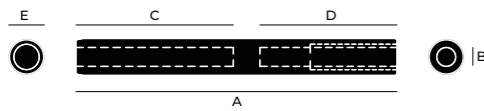

Olhal com
cabo aplicado /
Eye terminal with
cable installed /
Tornillo con
cable aplicado.
IN.10.---.C + X
(Comprimento de cabo
Cable length /
Largo de cable)

Swage Eye terminal AISI 316

IN.10.233 / Un.
IN.10.333 / Un.
IN.10.433 / Un.
IN.10.633 / Un.
IN.10.833 / Un.



Olhal para cravar cabo de aço /
Swage eye terminal to stamp wire rope /
Cancamo para cravar cable de acero.

EN 1.4401 - AISI 316

REF	Ø Cable	MÁX LOAD	A mm	B mm	C mm	D mm
IN.10.233	2,5	260 kg	50	4,5	38	3
IN.10.333	3	400 kg	57	6,5	35	4
IN.10.433	4	630 kg	66	8,5	40	6
IN.10.633	6	1330 kg	75	13	35	8
IN.10.833	8	2450 kg	125	14,5	85	9

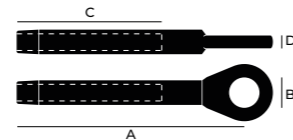

Eye terminal with external thread

IN.10.235 / Un.
IN.10.335 / Un.
IN.10.230 / Un.
IN.10.430 / Un.
IN.10.630 / Un.
IN.10.635 / Un.
IN.10.835 / Un.



Olhal com rosca métrica exterior e contraporca de bloqueio. /
Eye terminal with extered metric thread and locking nut /
Cancamo con hilo métrico exterior y tuerca de bloqueio.
EN 1.4401 - AISI 316

REF	Ø Cable	MÁX LOAD	METRIC	A mm	B mm	C mm	D mm
IN.10.235	2,5	260 kg	M4	40	4,5	26	2,5
IN.10.335	3	400 kg	M5	65	5,5	41	3
IN.10.230	4	630 kg	M6	67	6	47	4
IN.10.430	4	630 kg	M8	79	8,5	53	5
IN.10.630	6	1330 kg	M10	91	10,5	62	6
IN.10.635	6	1540 kg	M12	112	13,2	79	7,5
IN.10.835	8	2450 kg	M16	113	12,5	80	8

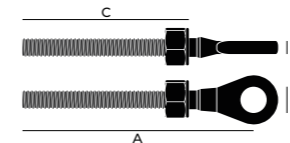

Dome head terminal with internal thread

IN.10.236 / Un.
IN.10.336 / Un.
IN.10.436 / Un.
IN.10.636 / Un.



Esticador com rosca interior com entrada hexagonal para chave allen /
Inside thread tensioner Internal with hexagonal entry for allen key /
Tensor roscado interior con entrada hexagonal para llave allen.

EN 1.4401 - AISI 316

REF	Ø Cable	A mm	B mm	C mm	D
IN.10.236	2,5	39	10	7,5	M5
IN.10.336	3	30	12	8	M6
IN.10.436	4	55,5	14	11	M8
IN.10.636	6	60	18	14	M10

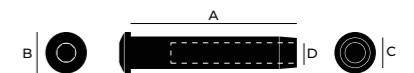



Wire rope scissor

For 2 to 8mm

IN.10.ACO / Un.

Alicate de corte de cabo de aço /
Wire rope cutter /
Cortador de cable de acero



Swaging crimping tool

For DIN 3093

IN.10.ACR / Un.

Alicate para cravar cabo de aço com DIN 3093 /
Wire rope crimping Pliers for DIN 3093 /
Alicates para prensar cables con DIN 3093.



Stopper

For wire 4mm

IN.10.051 / Un.

Cerra cabos /
Wire rope stopper / Sujetacables.

EN 1.4401 - AISI 316

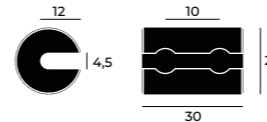

Stopper

For wire 4mm

IN.10.052 / Un.

Cerra cabos /
Wire rope stopper / Sujetacables.

EN 1.4401 - AISI 316



Oval sleeve DIN 3093

Stainless steel

IN.10.280 / Un.
IN.10.380 / Un.



Argola para cravar cabo de aço /
Ring to swage wire rope / Anillo para estampar cable de acero inox.

EN 1.4401 - AISI 316

REF	Ø Cable	A mm	B mm	C mm
IN.10.280	2,5	7	5	10
IN.10.380	3	9,5	6	10



Oval sleeve

Aluminium

IN.10.480 / Un.
IN.10.680 / Un.
IN.10.880 / Un.

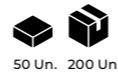

Argola para cravar cabo de aço /
Ring to swage wire rope / Anillo para estampar cable de acero inox.
Alumínio / Aluminium

REF	Ø Cable	A mm	B mm	C mm
IN.10.480	4	12,5	8	14
IN.10.680	6	18	12	14
IN.10.880	8	24	15,5	28,5



Cross clamp

For wire 4mm

IN.10.053 / Un.

Cerra cabos cruzado /
Wire rope cross clamp /
Sujetacables cruzado.

EN 1.4401 - AISI 316

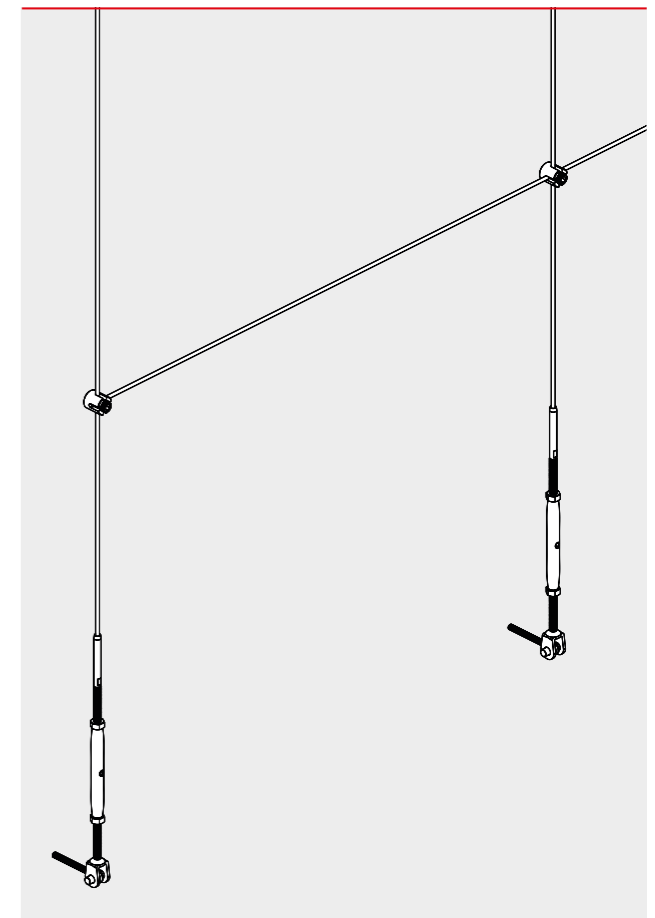
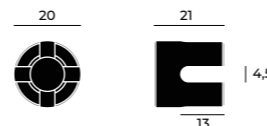



Wire rope clip

DIN 741 type

IN.10.250 / Un.
IN.10.350 / Un.
IN.10.050 / Un.
IN.10.650 / Un.
IN.10.850 / Un.

Cerra cabos /
Wire rope clip / Sujetacables.

EN 1.4401 - AISI 316

REF	Ø Cable	A mm	B mm	C mm	D mm
IN.10.250	2,5	16	18	3	8
IN.10.350	3	20	20	3,5	9
IN.10.050	4	22,5	22,5	4	10
IN.10.650	6	25	28	4,3	11,5
IN.10.850	8	29,5	34,5	5,3	13,5

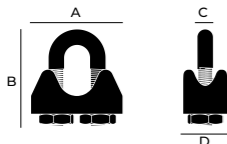

Wire rope thimble

AISI 316

IN.10.240 / Un.
IN.10.340 / Un.
IN.10.040 / Un.
IN.10.640 / Un.
IN.10.840 / Un.

Argola para cabo de aço para formar olhal reforçado no cabo de aço / Wire rope thimble for forming hard reinforced eyes in wire rope loops / Anillo para cable de acero para formar un cancamo reforzado en el cable de acero.

EN 1.4401 - AISI 316

REF	Ø Cable	A mm	B mm
IN.10.240	2,5	13,5	19,5
IN.10.340	3	15	22,5
IN.10.040	4	17,5	28
IN.10.640	6	23	36
IN.10.840	8	29	44

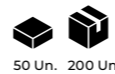
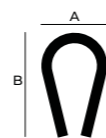

Spring hook

Snap hook

IN.10.101 / Un.
IN.10.102 / Un.
IN.10.103 / Un.
IN.10.104 / Un.
IN.10.105 / Un.
IN.10.106 / Un.

Mosquetão /
Snap hook / Mosquetón.

EN 1.4401 - AISI 316

REF	A mm	B mm	C mm	MÁX LOAD
IN.10.101	25	50	5	140 kg
IN.10.102	29	60	6	170 kg
IN.10.103	39	80	8	220 kg
IN.10.104	50	100	10	240 kg
IN.10.105	68	140	12	280 kg
IN.10.106	88	178	14	320 kg

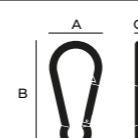

Quick link

Security snap hook

IN.10.109 / Un.
IN.10.110 / Un.
IN.10.111 / Un.
IN.10.112 / Un.
IN.10.113 / Un.

Mosquetão de segurança /
Security snap hook /
Mosquetón de seguridad.

EN 1.4401 - AISI 316

REF	A mm	B mm	C mm	MÁX LOAD
IN.10.109	22	40	4	150 kg
IN.10.110	26	49	5	210 kg
IN.10.111	30	59	6	280 kg
IN.10.112	37	74	8	500 kg
IN.10.113	45	89	10	730 kg

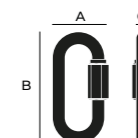



Bow Shackle

Screw pin

IN.10.131 / Un.
IN.10.132 / Un.
IN.10.133 / Un.
IN.10.134 / Un.

Manilha balão /
Bow shackle / Grillete lira.

EN 1.4401 - AISI 316

REF	A mm	B mm	C mm	MÁX LOAD
IN.10.131	32	25	5	500 kg
IN.10.132	32	40	6	800 kg
IN.10.133	42	50	8	1300 kg
IN.10.134	50,5	62,5	10	2100 kg

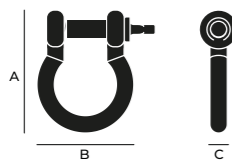

D Shackle

Screw pin

IN.10.120 / Un.
IN.10.121 / Un.
IN.10.122 / Un.
IN.10.123 / Un.

Manilha recta /
D Shackle / Grillete recto.

EN 1.4401 - AISI 316

REF	A mm	B mm	C mm	MÁX LOAD
IN.10.120	32	20	5	600 kg
IN.10.121	37	24	6	1000 kg
IN.10.122	50	31	8	1700 kg
IN.10.123	64	40	10	2500 kg

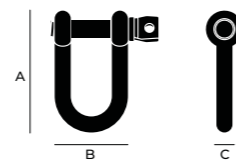

Round ring

Welded

IN.10.140 / Un.
IN.10.141 / Un.
IN.10.142 / Un.
IN.10.143 / Un.

Argola /
Round ring / Anilla.

EN 1.4401 - AISI 316

REF	A mm	B mm	MÁX LOAD
IN.10.140	Ø39	3	60 kg
IN.10.141	Ø39	4	100 kg
IN.10.142	Ø48	6	150 kg
IN.10.143	Ø64	8	200 kg



Oblong pad eye

Welded

IN.10.724.40 / Un.
IN.10.724.60 / Un.
IN.10.724.80 / Un.

Olhal com base /
Based eye plate / Ojillo con base.

EN 1.4401 - AISI 316

REF	A mm	B mm	C mm	D mm	E mm
IN.10.724.40	40	21,5	13	21	5
IN.10.724.60	60	26	20	30	6
IN.10.724.80	80	34,5	26	38	8

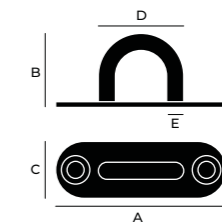

ARTEMIS HANGING FRAMES SYSTEM



**SISTEMA DE SUSPENSÃO
DE MOLDURAS /**
SISTEMA DE SUSPENSIÓN
DE CUADROS

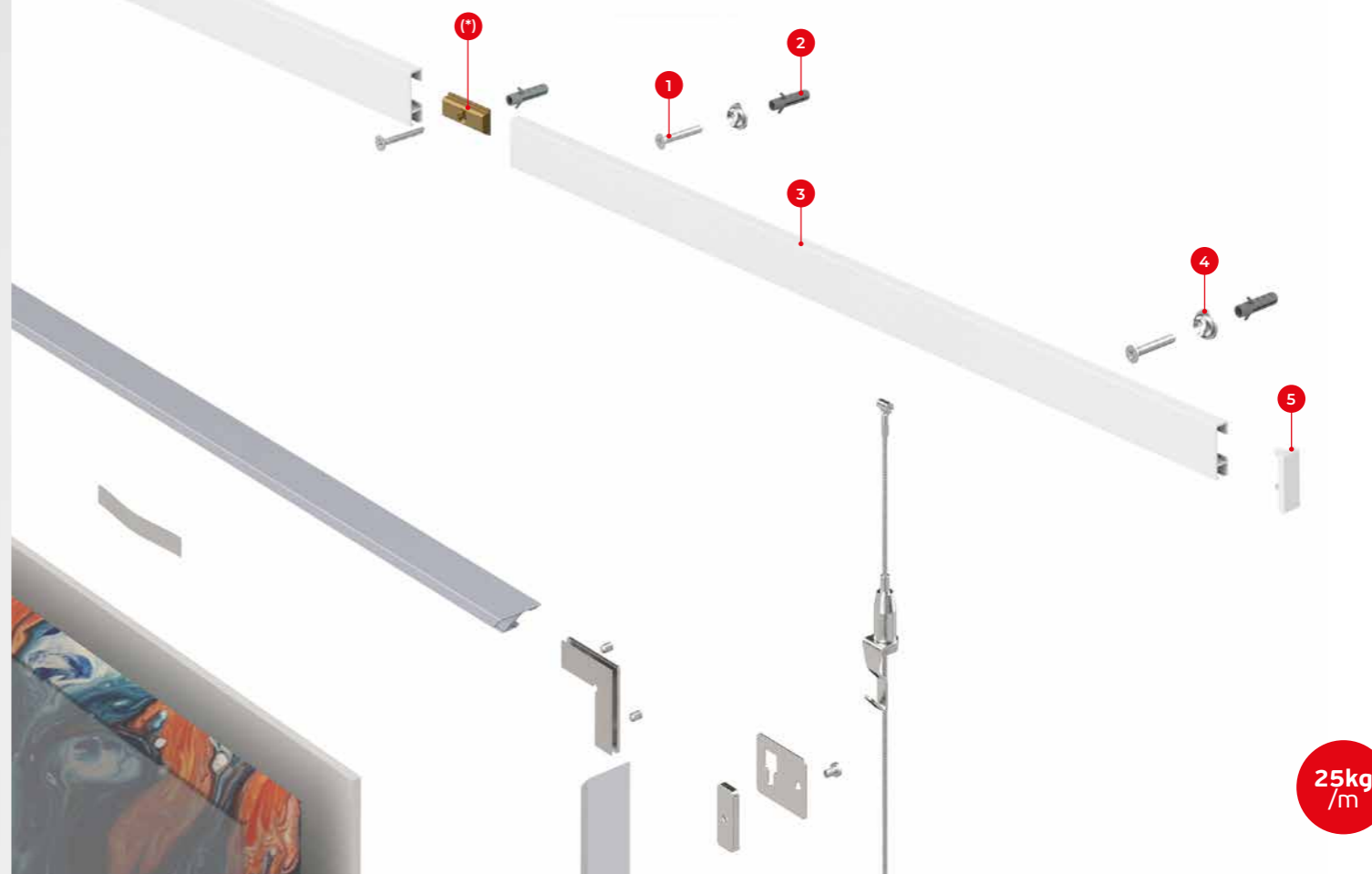

Hanging frames kit Artemis

IN.29.001.2000 / Set

Kit de perfil de alumínio para suspensão de molduras, com
com fixações e tampas. Perfil de alumínio de 2000mm em
cor branco e peso máximo até 25kg/m. Conector de perfil não
incluído /

Kit of aluminum profile for hanging frames, with fixings and
covers. 2000mm aluminum profile in white color and maximum
weight up to 25kg/m. Profile connector not included /

Kit de perfil de Alumínio para suspensión de cuadros, con
fijaciones y cobiertas. Perfil de Alumínio de 2000mm en color
blanco y peso máximo hasta 25kg/m. Conector de perfil no
incluído.

1. Parafuso DIN 7982 (4x40mm) /
DIN 7982 screw / Tornillo DIN 7982
2. Buchas / Plugs / Tacos
3. Perfil alumínio branco (2000mm) /
White aluminium profile (2000mm) /
Perfil Alumínio branco (2000mm)
4. Fixações / Fixings / Fijaciones
5. Tampas / Covers / Cubiertas

(*)
IN.29.006 / Un.

Conector de perfil (não incluído) /
Profile connector (not included) /
Conector de perfil (no incluído)



1 Un. 10 Un.

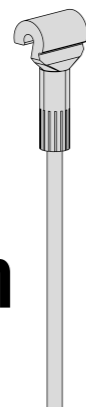

Suspension system

Nylon cable

IN.29.003.1820 / Un.
IN.29.003.3000 / Un.

Sistema de suspensão com cabo de nylon de 2mm. (peso máximo: 7kg) / Suspension system with 2mm nylon cable. (maximum weight: 7kg) / Sistema de suspensión con cable de nylon de 2mm (peso máximo: 7kg)

Nylon / Nylon / Nailon



1 Un. 50 Un.

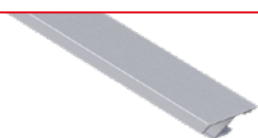

Frame profile

Silver 3000mm

IN.29.007.3000 / Un.

Perfil em alumínio para moldura (3000mm) / Aluminum profile for frame (3000mm) / Perfil de Aluminio para cuadro (3000mm).



4 Un. 20 Un.

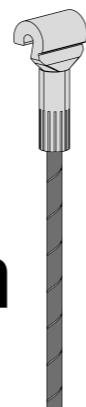

Suspension system

Stainless steel cable

IN.29.002.1820 / Un.
IN.29.002.3000 / Un.

Sistema de suspensão com cabo de aço inox de 2mm (peso máximo: 20kg) / Suspension system with 2mm stainless steel cable (maximum weight: 20kg) / Sistema de suspensión con cable de acero inoxidable de 2mm (peso máximo: 20kg)

Aço inoxidável / Stainless steel / Acero inoxidable



1 Un. 50 Un.



Frame profile

Black 3000mm

IN.29.007.3000.B / Un.

Perfil em alumínio lacado a preto para moldura (3000mm) / Black lacquered aluminum profile for frame (3000mm) / Perfil de Aluminio lacado a negro para cuadro (3000mm).



4 Un. 20 Un.

move easily
from side to side

black or silver frame



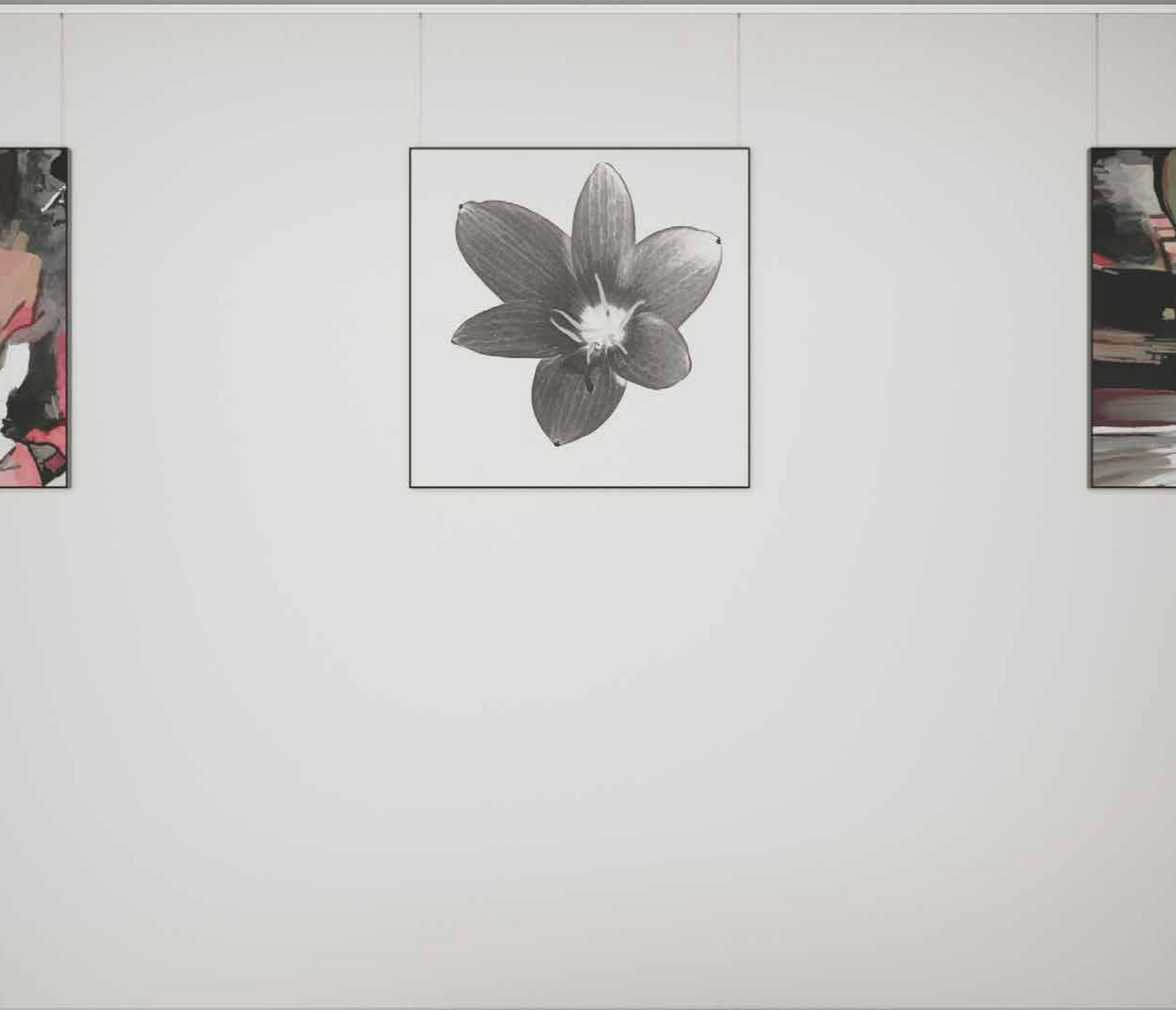

Hook for Artemis

IN.29.004 / Un.

Gancho para sistema de suspensão de molduras. Pode ser utilizado com cabo de aço ou de nylon. O gancho é retráctil e ajustável. (peso máximo: 15kg) /

Hook for frame suspension system. Can be used with steel or nylon cable. The hook is retractable and adjustable. (maximum weight: 15 kg) /

Gancho para sistema de suspensión del cuadro. Se puede utilizar con cable de acero o nailon. El gancho es retráctil y ajustable. (peso máximo: 15kg).

Latão niquelado / Brass nickel

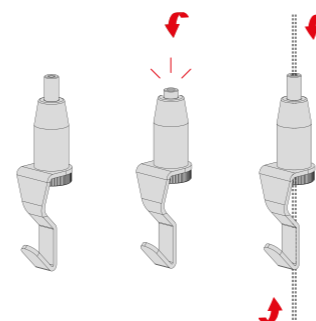

10 Un. 100 Un.



Spring hook for Artemis

IN.29.005 / Un.

Gancho de mola para sistema de suspensão de molduras. Pode ser utilizado com cabo de aço ou de nylon. O gancho é retráctil e ajustável. (peso máximo: 3kg) /

Spring hook for frame suspension system. Can be used with steel or nylon cable. The hook is retractable and adjustable. (maximum weight: 3 kg) /

Gancho de muelle para sistema de suspensión del cuadro. Se puede utilizar con cable de acero o nailon. El gancho es retráctil y ajustable. (peso máximo: 3kg).

Aço niquelado / Nickel

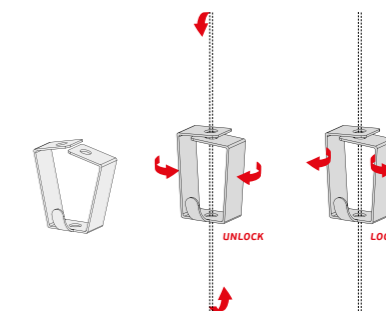

10 Un. 100 Un.

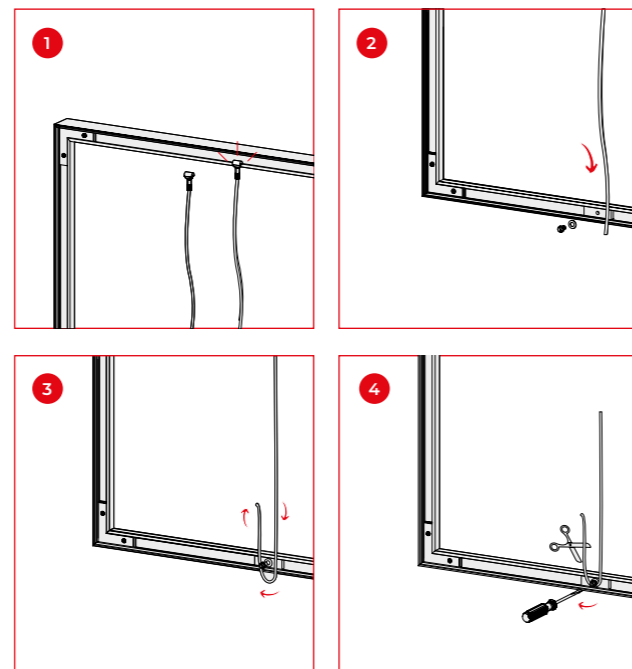
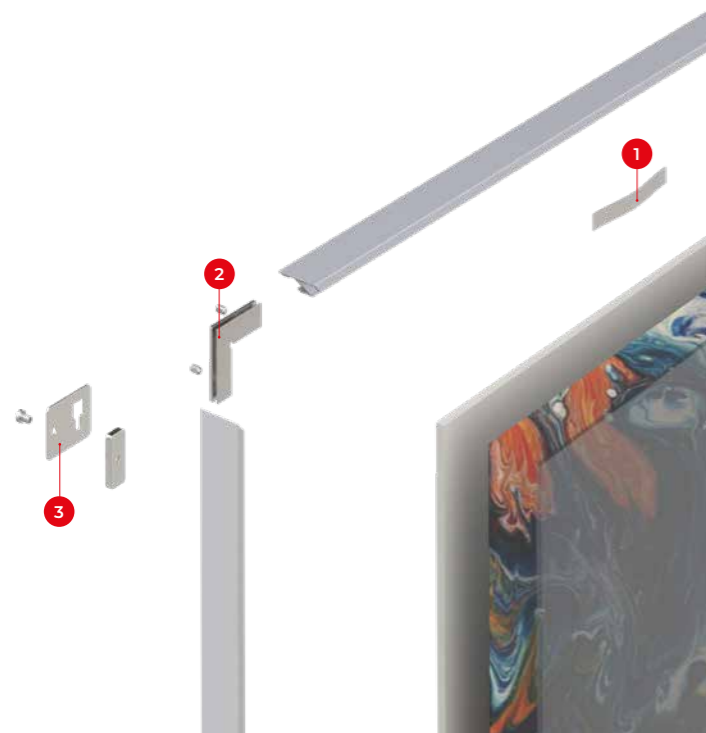

1 Conecte o cabo ao perfil de alumínio | Connect the cable to aluminium profile | Conecte el cable al perfil de aluminio.
2 Estique o cabo até ao final do perfil | Stretch the cable to the end of the profile | Estire el cable hasta el final del perfil.
3 Estique o cabo até ao final do perfil | Stretch the cable to the end of the profile | Estire el cable hasta el final del perfil.
4 Aparafuse e corte o excesso de cabo | Screw and cut the excess cable | Atornille y corte el cable sobrante.

Frame suspension complete kit

IN.29.011 / Un.

Kit completo para suspensão de molduras, O kit inclui: esquadros com parafuso DIN 551 (4 sets), suporte de gancho de parede com parafuso DIN 85 (2 sets) e molas de ajuste (6 unidades) /

Complete kit for frame suspension, The kit includes: brackets with DIN 551 screws (4 sets), hook/wall bracket with DIN 85 screws (2 sets) and adjustment springs (6 units) /

Kit completo para suspensión del cuadro, El kit inclui: soportes con tornillos DIN 551 (4 sets), soporte de gancho/pared con tornillos DIN 85 (2 sets) y resortes de ajuste (6 unidades).

1. Mola de ajuste / Adjustment spring / Resorte de ajuste
2. Esquadros / Brackets / Soportes
3. Suporte de gancho-parede / Hook-wall bracket / Soporte de gancho-pared

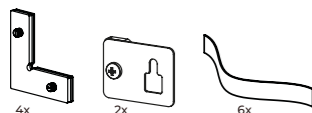

1 Set. 10 Set.

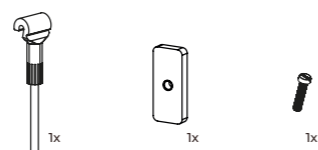

1 Set. 10 Set.

Frame suspension stabilizer kit

IN.29.012 / Un.

Kit estabilizador para o sistema de suspensão de molduras ARTEMIS. A sua utilização é necessária quando o comprimento X > 600mm. O kit inclui: IN.29.003.1820, IN.29.009.2 e parafuso DIN85 - M4x6 /

Stabilizer kit for the ARTEMIS frame suspension system. Its use is necessary when the length X > 600mm. The kit includes: IN.29.003.1820, IN.29.009.2 and DIN85 - M4x6 screw /

Kit estabilizador para el sistema de suspensión del cuadro ARTEMIS. Su uso es necesario cuando la longitud X > 600 mm. El kit incluye: IN.29.003.1820, IN.29.009.2 y tornillo DIN85 - M4x6.





Double wire support for glass

IN.10.723 / Un.

Suporte duplo de cabo para vidro de 6mm /
Double wire support for glass - 6mm /
Soporte doble de cable para cristal de 6mm.

EN 1.4301 - AISI 304
Satinado | Satin



1 Un. 30 Un.

Wire support for glass

IN.10.722 / Un.

Suporte de cabo para vidro de 6mm /
Wire support for glass 6mm /
Soporte de cable para cristal de 6mm.

EN 1.4301 - AISI 304
Satinado | Satin



1 Un. 30 Un.

Support and tensioner for steel cables

IN.10.716 / Un.

Suporte e esticador /
Support and tensioner /
Soporte y tensor.

EN 1.4301 - AISI 304
Satinado | Satin



1 Un. 40 Un.

Support and tensioner articulated

IN.10.715 / Un.

Suporte e esticador articulado /
Articulated support and tensioner /
Soporte y tensor articulado.

EN 1.4301 - AISI 304
Satinado | Satin



1 Un. 20 Un.

Wire support for wood

IN.10.720 / Un.

Suporte de cabo para madeira /
Wire support for wood /
Soporte de cable para madera.

EN 1.4301 - AISI 304
Satinado | Satin



1 Un. 30 Un.

Double wire support for wood

IN.10.721 / Un.

Suporte duplo para cabo para madeira /
Double wire support for wood /
Soporte doble de cable para madera.

EN 1.4301 - AISI 304
Satinado | Satin



1 Un. 30 Un.

6

FERRAGENS PARA VIDRO / GLASS HARDWARE HERRAJES PARA CRISTAL.

6.1
L SYSTEM

6.2
Q SYSTEM

6.3
Q2 SYSTEM

6.4
F SYSTEM

6.5
PIVOT E BATENTES DE PORTA /
PIVOT AND DOOR STOPPERS /
PIVOTE Y TOPES DE PUERTA.

6.6
MOLA DE PAVIMENTO
FLOOR CLOSER /
CIERRA PUERTA DE SUELO

6.7
FECHADURA PARA PORTAS DE
VIDRO / DOOR LOCK FOR GLASS /
CERRADURA PARA PUERTAS DE
CRISTAL.

6.8
DOBRADIÇAS E SUPORTES PARA
VIDRO / HINGES & SUPPORT
SYSTEMS FOR GLASS / BISAGRAS Y
SOPORTES PARA CRISTAL.

6.9
SOLUÇÕES DE FERRAGENS
PARA CABINES DE VIDRO /
GLASS HARDWARE SOLUTIONS FOR
CABINS / SOLUCIONES DE HERRAJES
PARA CABINAS DE CRISTAL.

6.10
CONCHAS PARA PORTAS DE
VIDRO / FLUSH HANDLE FOR GLASS
DOORS / CAZOLETA PARA PUERTAS
DE CRISTAL.

6.11
PUXADOR PARA PORTAS
DE VIDRO / KNOB FOR GLASS
DOORS / POMO PARA PUERTAS
DE CRISTAL.

6.12
ASAS DE PORTA PARA VIDRO /
DOOR HANDLES FOR GLASS /
MANILLONES DE PUERTA
PARA CRISTAL.

6.13
SISTEMAS DE FIXAÇÃO
PARA VIDRO / SUPPORT SYSTEMS
FOR GLASS / SISTEMAS DE FIJACIÓN
PARA CRISTAL.

6.14
FECHADURAS AUXILIARES /
AUXILIARY LOCKS /
CERRADURAS AUXILIARES.

6.15
K60 | K110 PARA PORTAS
DE CORRER DE VIDRO.
K60 | K110 FOR GLASS SLIDING
DOORS / K60 | K110 PARA PUERTAS
CORREDERAS DE CRISTAL.

6.16
CARRIL SUPERIOR E SUPORTES /
UPPER TRACK AND SUPPORTS /
CARRIL SUPERIOR Y SOPORTES.

6.17
CHARRIOT PARA PORTAS DE
CORRER DE VIDRO /
CHARRIOT FOR GLASS SLIDING
DOORS / CHARRIOT PARA PUERTAS
CORREDERAS DE CRISTAL.

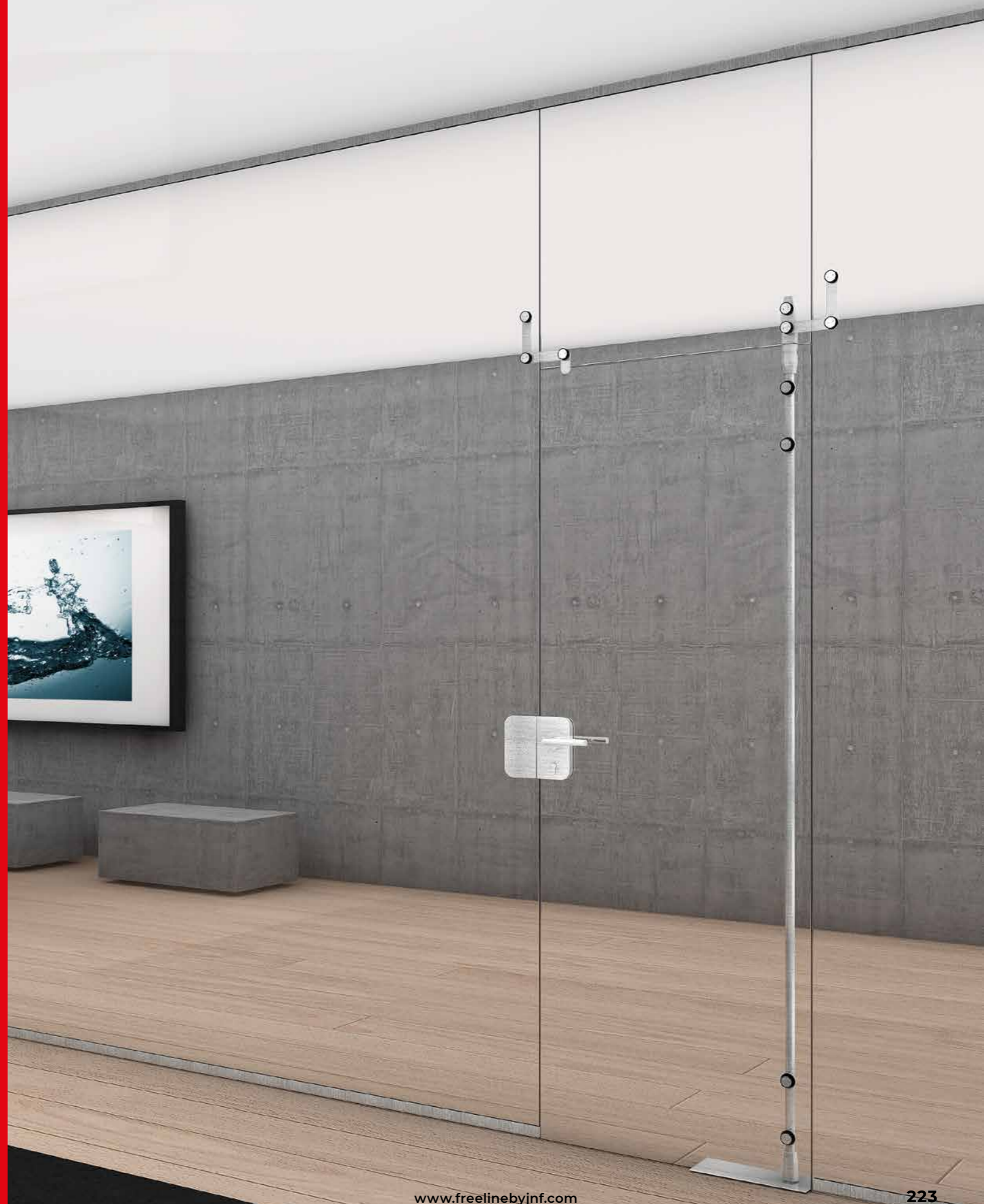



L system for glass

Door pivot

IN.81.210 / Set
IN.81.210.R / Set
IN.81.210.S / Set

Conjunto de pivot superior e inferior para portas de vidro. Pode ser aplicado numa mola ou num giro de pavimento / Upper and bottom pivot kit for glass doors. Can work with a floor closer or a floor pivot / Conjunto de pivote superior y inferior para cristal. Puede funcionar con un cierra puertas de suelo o con un pivote de suelo.

EN 1.4301 - AISI 304
Satinado | Satin

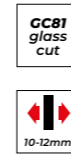
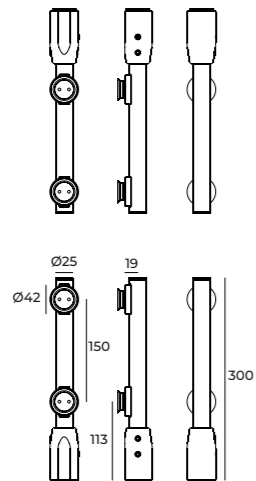

L system for glass

Overpanel pivot

IN.81.212 / Set
IN.81.212.R / Set
IN.81.212.S / Set

Pivot para painel de vidro superior com suporte lateral à parede. Reversível / Overpanel pivot for glass superior with wall fixing. Reversible / Pivote para cristal superior y fijacion a la pared lateral. Reversible.

EN 1.4301 - AISI 304
Satinado | Satin

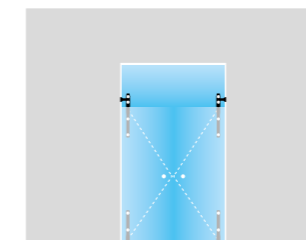
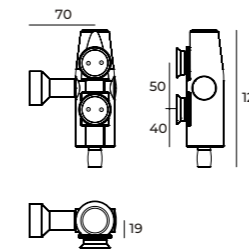

L system for glass

complete door pivot

IN.81.211 / Set
IN.81.211.R / Set
IN.81.211.S / Set

Conjunto de pivot superior e inferior para portas de vidro. Pode ser aplicado numa mola ou num giro de pavimento / Upper and bottom pivot kit for glass doors. Can work with a floor closer or a floor pivot / Conjunto de pivote superior y inferior para cristal. Puede funcionar con un cierra puertas de suelo o con un pivote de suelo.

EN 1.4301 - AISI 304
Satinado | Satin

Altura máxima da porta /
Max. door height /
Altura máxima de la puerta:
2600mm

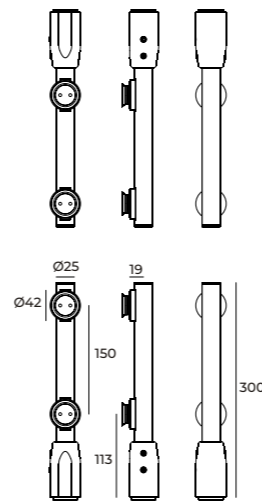

L system for glass

Overpanel pivot

IN.81.213 / Set
IN.81.213.R / Set
IN.81.213.S / Set

Pivot para painel de vidro superior e lateral. Reversível / Overpanel and side panel pivot for glass. Reversible / Pivote para cristal superior y lateral. Reversible.

EN 1.4301 - AISI 304
Satinado | Satin

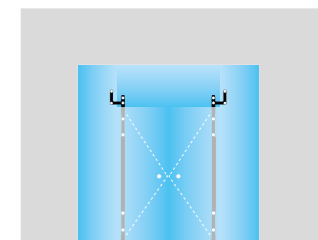
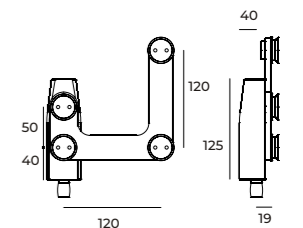

GC83
glass
cut

10-12mm



L system for glass

Overpanel pivot

IN.81.214 / Un.
IN.81.214.R / Un.
IN.81.214.S / Un.

Pivot para painel de vidro superior /
Overpanel pivot for glass /
Pivote para cristal superior.

EN 1.4301 - AISI 304
Satinado | Satin

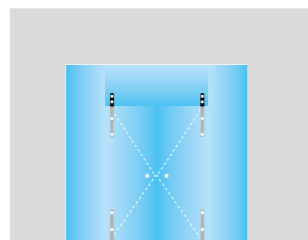
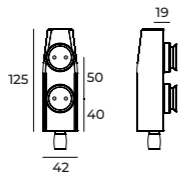

1 Un. 5 Un.

GC84
glass
cut

10-12mm

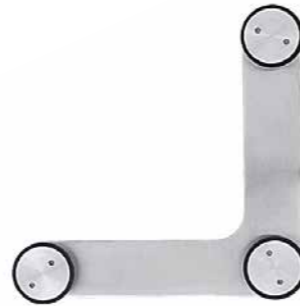

L system for glass

Over / side panel

IN.81.215 / Un.

Fixação superior e lateral.
Reversível /
Over and side panel.
Reversible /
Fijación superior y lateral
para cristal. Reversible.

EN 1.4301 - AISI 304
Satinado | Satin

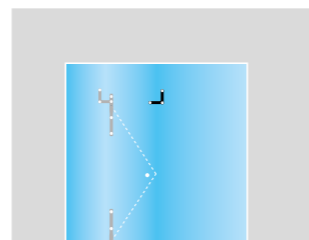
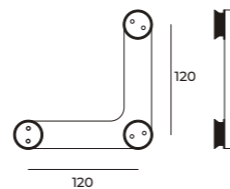

1 Un. 5 Un.

GC84
glass
cut

10-12mm



L system for glass

Over / side panel stopper

IN.81.216 / Un.

Fixação superior e lateral
com batente. Reversível /
Over and side panel with
stopper. Reversible /
Fijación superior y lateral
con tope. Reversible.

EN 1.4301 - AISI 304
Satinado | Satin

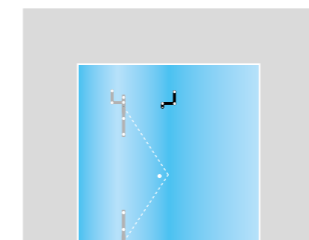
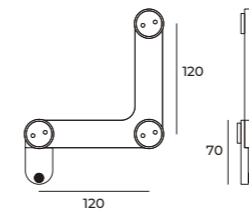

1 Un. 5 Un.

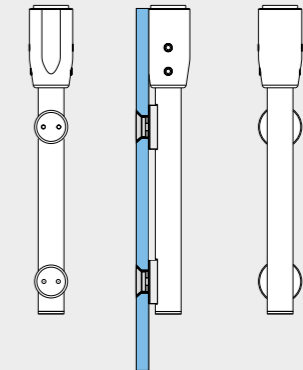

IN.81.214
Sistema standard.
Furo no vidro
escareado /
Standard system.
Glass hole with
countersunk /
Sistema estandard.
Talladro en el cristal
con escareado.

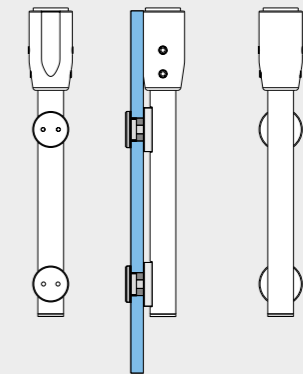

IN.81.215
Sistema de fixação
com furo directo no
vidro /
Fixing system with
direct hole in the
glass /
Sistema de fijación
con talladro en el
cristal.

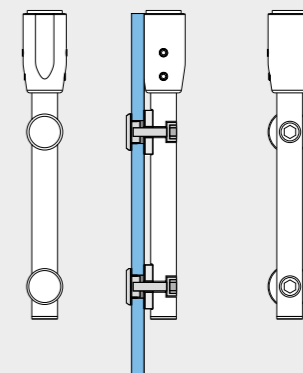

IN.81.216
Sistema de
segurança, acesso às
fixações apenas pelo
interior. Fixação com
furo directo no vidro /
Security fixing system,
only can access from
inside. Fixing system
with direct hole in the
glass / Sistema de
seguridad, el acceso a
las fijaciones solo por
el interior. Fijación
con talladro direto en
el cristal.

Q SYSTEM FOR GLASS

Q SYSTEM PARA VIDRO

Q SYSTEM PARA CRISTAL

Sistemas para construção de divisórias em vidro de 10 ou 12 mm. Corpo em alumínio lacado. Tampas em aço inoxidável EN 1.4301. Sistema de encaixe rápido. Parafusos de fixação do vidro em ambos os lados.

Fixing system for 10 or 12mm glass panels. Body made in aluminum with lacquering finish. Covers made in stainless steel EN 1.4301. Fast plug system. Screws for fixing the glass on both sides.

Sistema de fijación de paneles de cristal con 10 o 12 mm. Cuerpo fabricado en aluminio lacado. Cubiertas en acero inoxidable EN 1.4301. Sistema de encaje rápido. Tornillos de fijación del cristal en ambos lados.



Q System for glass 5 in 1 pivot - Satin

IN.81.110 / Set

5 em 1 - Conjunto multifunções de pinça para vidro, este conjunto permite criar pivot inferior, pivot superior, pivot superior de bandeira, com dois tipos de fixação /
5 in 1 - Multifunctional set of patch fitting, this set can create bottom pivot, upper pivot overhead pivot with two fixing types /
5 en 1 - Juego de pinzas multifuncionales para cristal, este juego permite crear pivote inferior, pivote superior, pivote de bandera superior, con dos tipos de fijación.

EN 1.4301 - AISI 304
Satinado | Satin

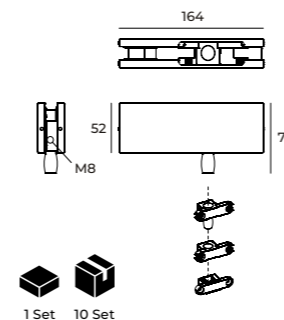

1 Set 10 Set

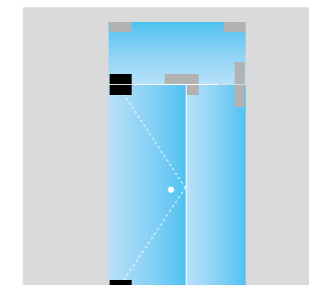

Q System for glass 5 in 1 pivot - Mirror

IN.81.110.P / Set

5 em 1 - Conjunto multifunções de pinça para vidro, este conjunto permite criar pivot inferior, pivot superior, pivot superior de bandeira, com dois tipos de fixação /
5 in 1 - Multifunctional set of patch fitting, this set can create bottom pivot, upper pivot overhead pivot with two fixing types /
5 en 1 - Juego de pinzas multifuncionales para cristal, este juego permite crear pivote inferior, pivote superior, pivote de bandera superior, con dos tipos de fijación.

EN 1.4301 - AISI 304
Polido | Polished | Pulido.

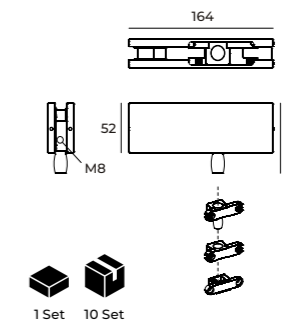

1 Set 10 Set

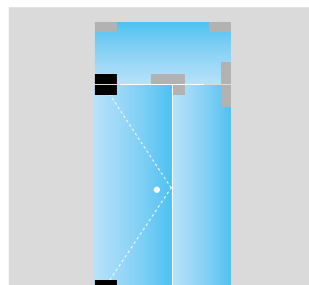



Q System for glass Patch fitting

IN.81.110.1 / Un.

Giro inferior para vidro /
Bottom patch fitting /
Giro inferior para cristal.

EN 1.4301 - AISI 304
Satinado | Satin

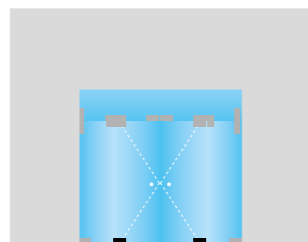
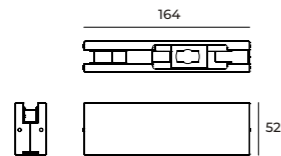

Q System for glass Patch fitting

IN.81.110.4 / Un.

Giro inferior para vidro /
Bottom patch fitting /
Giro inferior para cristal.

EN 1.4301 - AISI 304
Satinado | Satin

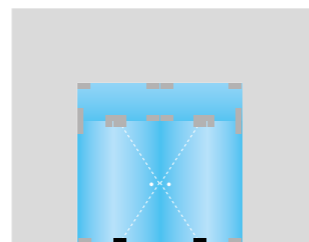
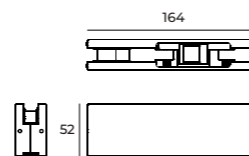

Q System for glass Patch fitting

IN.81.110.2 / Un.

Suporte superior de giro para vidro /
Overpanel pivot patch fitting /
Soporte superior de giro para cristal.

EN 1.4301 - AISI 304
Satinado | Satin

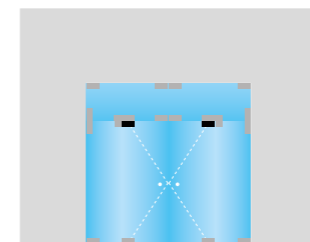
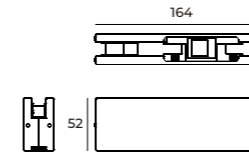

Q System for glass Stop patch fitting

IN.81.110.7 / Un.

Suporte superior para vidro com batente /
Top patch fitting with stopper /
Soporte superior para cristal con tope.

EN 1.4301 - AISI 304
Satinado | Satin

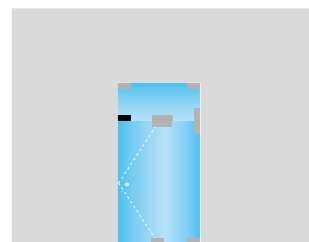
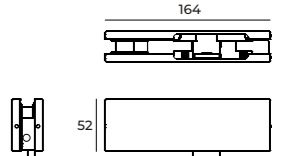



GC02
glass
cut

10-12mm

Q System for glass Patch fitting - Satin

IN.81.111.1 / Un.

Suporte de bandeira com giro /
Panel side support with pivot /
Soporte lateral de panel con pivote.

EN 1.4301 - AISI 304
Satinado | Satin

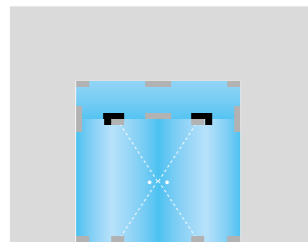
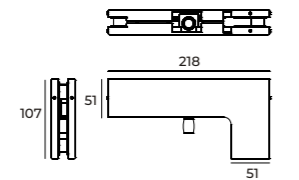

1 Un. 10 Un.



GC02
glass
cut

10-12mm

Q System for glass Patch fitting - Mirror

IN.81.111.1.P / Un.

Suporte de bandeira com giro /
Panel side support with pivot /
Soporte lateral de panel con pivote.

EN 1.4301 - AISI 304
Polido | Polished | Pulido.

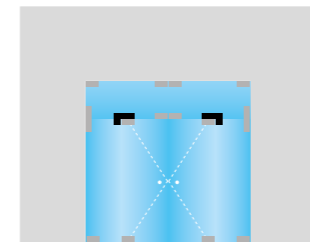
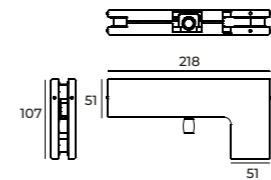

1 Un. 10 Un.

1 Un. 10 Un.



GC02
glass
cut

10-12mm

Q System for glass Patch fitting - Satin

IN.81.111.2 / Un.

Suporte de bandeira com batente /
Panel side support with stopper /
Soporte lateral de panel con tope.

EN 1.4301 - AISI 304
Satinado | Satin

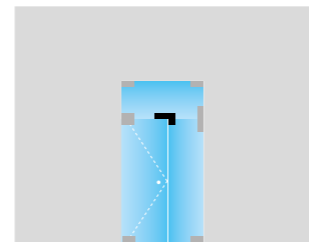
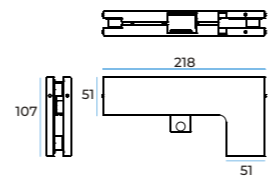

1 Un. 10 Un.

1 Un. 10 Un.



GC02
glass
cut

10-12mm

Q System for glass Patch fitting - Mirror

IN.81.111.2.P / Un.

Suporte de bandeira com batente /
Panel side support with stopper /
Soporte lateral de panel con tope.

EN 1.4301 - AISI 304
Polido | Polished | Pulido.

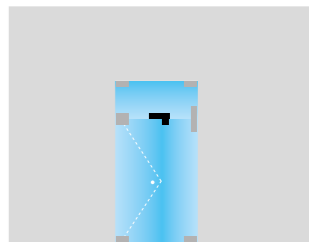
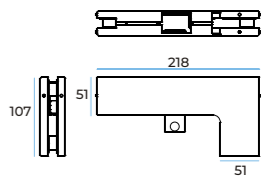

1 Un. 10 Un.

1 Un. 10 Un.



GC05
glass
cut



IN.81.115.1.D
na imagem /
on the image / en la imagen

Q System for glass Corner pivot

IN.81.115.1.D / Un.
(Direita / Right / Derecha)
IN.81.115.1.E / Un.
(Esquerda / Left / Izquierda)

Suporte de bandeira com giro /
Panel side support with pivot /
Soporte lateral de panel con giro.

EN 1.4301 - AISI 304
Satinado | Satin

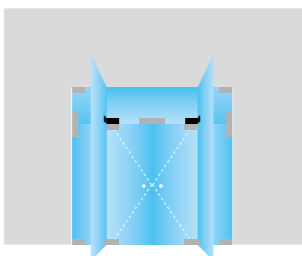
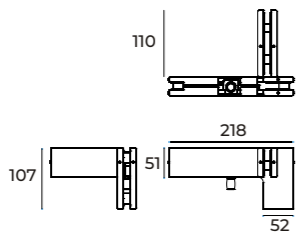

1 Un. 4 Un.



2 IN1

GC03
glass
cut



IN.81.115.2.D
na imagem /
on the image / en la imagen

Q System for glass Double pivot / stopper

IN.81.112 / Un.

Suporte de bandeira com giro ou batente /
Panel support with pivot or stopper /
Soporte de panel con giro o tope.

EN 1.4301 - AISI 304
Satinado | Satin

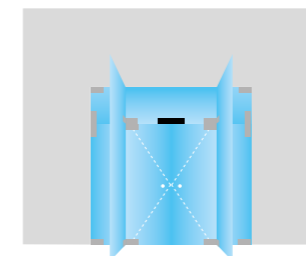
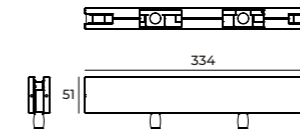

1 Un. 4 Un.



GC05
glass
cut



IN.81.115.2.D
na imagem /
on the image / en la imagen

Q System for glass Corner stopper

IN.81.115.2.D / Un.
(Direita / Right / Derecha)
IN.81.115.2.E / Un.
(Esquerda / Left / Izquierda)

Suporte de bandeira com batente /
Panel side support with stopper /
Soporte lateral de panel con tope.

EN 1.4301 - AISI 304
Satinado | Satin

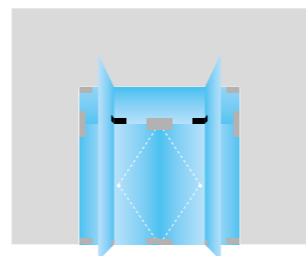
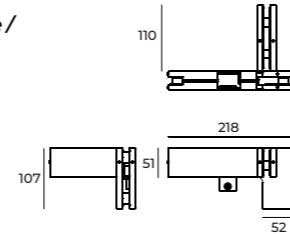

1 Un. 4 Un.



GC14
glass
cut



IN.81.126 / Un.

Suporte de bandeira com giro /
Panel side support with pivot /
Soporte lateral de panel
con pivote.

EN 1.4301 - AISI 304
Satinado | Satin

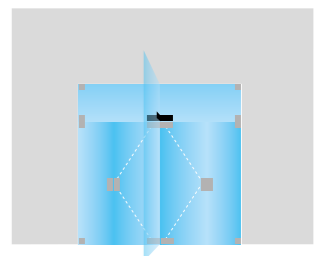
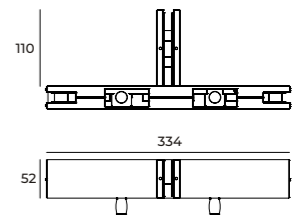

1 Un. 4 Un.



GC15
glass
cut

10-12mm

IN.81.127.D
na imagem /
on the image / en la imagen

Q System for glass

Corner pivot

IN.81.127.D / Un.

Suporte de bandeira com giro /
Panel side support with pivot /
Soporte lateral de panel con pivote.

EN 1.4301 - AISI 304
Satinado | Satin

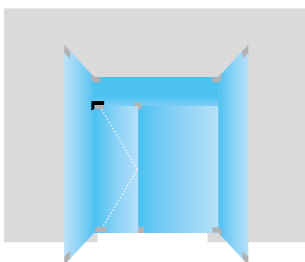
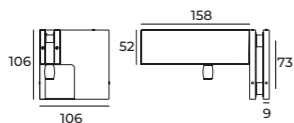

1 Un. 4 Un.



GC15
glass
cut

10-12mm

IN.81.127.E
na imagem /
on the image / en la imagen

Q System for glass

Corner pivot

IN.81.127.E / Un.

Suporte de bandeira com giro /
Panel side support with pivot /
Soporte lateral de panel con pivote.

EN 1.4301 - AISI 304
Satinado | Satin

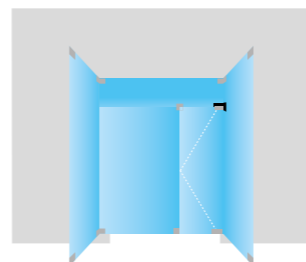
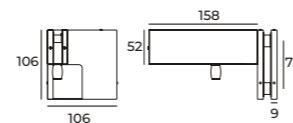

1 Un. 4 Un.





GC06
glass
cut



Q System for glass

Corner support / Mirror

IN.81.113.P / Un.

Fixador de canto /
Corner support /
Sujeción de esquina.

EN 1.4301 - AISI 304
Polido | Polished | Pulido

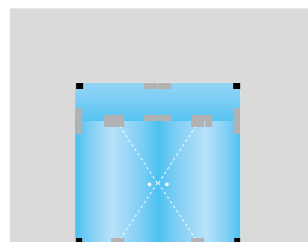
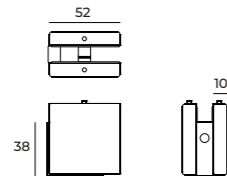

GC06
glass
cut



Q System for glass

Corner support

IN.81.113 / Un.

Fixador de canto /
Corner support /
Sujeción de esquina.

EN 1.4301 - AISI 304
Satinado | Satin

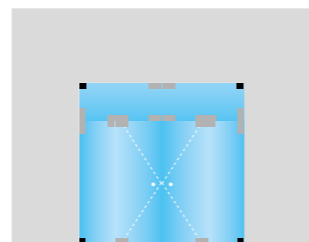
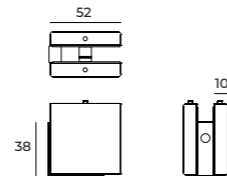

1 Un. 40 Un.



GC09
glass
cut



Q System for glass

Central support

IN.81.117 / Un.

Fixador de vidro /
Glass support /
Sujeción de cristal.

EN 1.4301 - AISI 304
Satinado | Satin

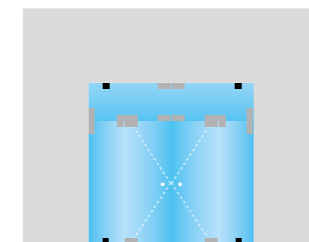
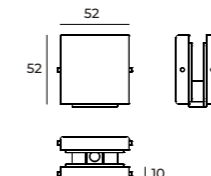

1 Un. 40 Un.



GC07
glass
cut



Q System for glass

Double glass support

IN.81.114 / Un.

Fixador duplo /
Double support /
Sujeción doble.

EN 1.4301 - AISI 304
Satinado | Satin

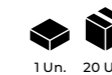
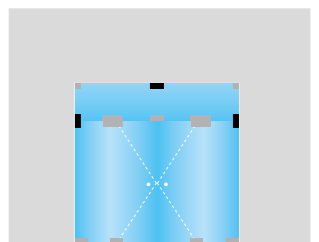
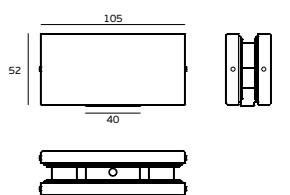

1 Un. 20 Un.



GC13
glass
cut

10-12mm

Q System for glass

Quadruple support

IN.81.124 / Un.

Suporte quádruplo para vidro /
Quadruple support for glass /
Soporte quádruplo para cristal.

EN 1.4301 - AISI 304
Satinado | Satin

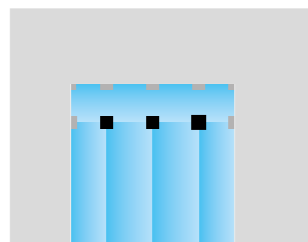
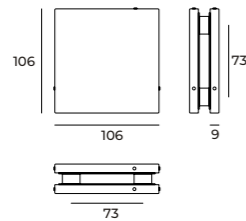

1 Un. 20 Un.



GC12
glass
cut

10-12mm

Q System for glass

Triple support with stop

IN.81.123 / Un.

Suporte triplo com
batente para vidro /
Triple support with stopper
for glass /
Soporte triple com
tope para cristal.

EN 1.4301 - AISI 304
Satinado | Satin

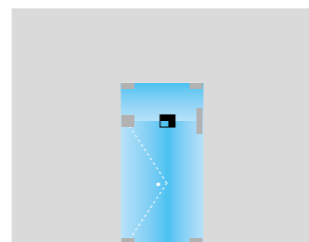
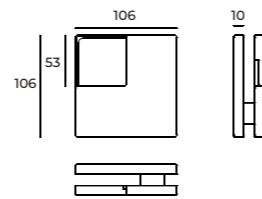

1 Un. 20 Un.

1 Un. 20 Un.



GC12
glass
cut

10-12mm

Q System for glass

Triple support

IN.81.125 / Un.

Suporte triplo para vidro /
Triple support for glass /
Soporte triple para cristal.

EN 1.4301 - AISI 304
Satinado | Satin

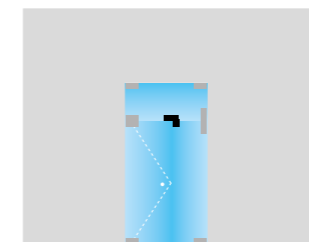
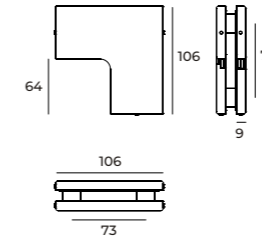

1 Un. 20 Un.

1 Un. 20 Un.



GC16
glass
cut

10-12mm

Q System for glass

90° support

IN.81.128 / Un.

Fixador de vidro /
Glass support /
Sujeción de cristal.

EN 1.4301 - AISI 304
Satinado | Satin

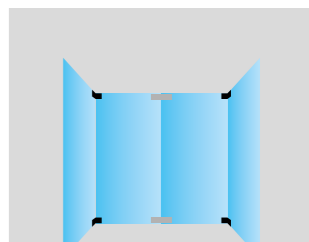
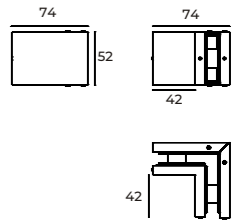

1 Un. 20 Un.

1 Un. 20 Un.



Q System for glass

Door vertical lock

IN.81.121 / Un.

Fechadura com cilindro europeu S10 (30+30) / Lock with european cylinder S10 (30+30) / Cerradura con cilindro europeo S10 (30x30).

EN 1.4301 - AISI 304
Satinado | Satin

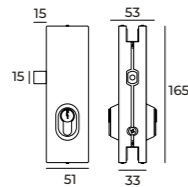

IN.81.121.T / Un.

Testa para fechadura IN.81.121 / Strike plate for lock IN.81.121 / Cerradero para cerradura IN.81.121.

EN 1.4301 - AISI 304
Satinado | Satin

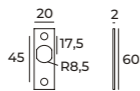

1 Un. 20 Un.

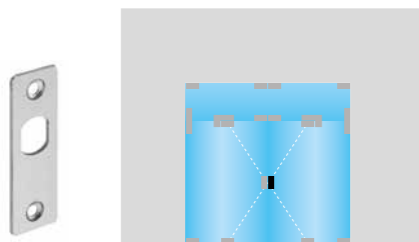

Q System for glass

Bottom door lock

IN.81.120 / Un.

Fechadura de pavimento com cilindro europeu S10 (30+30) / Floor lock with european cylinder S10 (30+30) / Cerradura de suelo con cilindro europeo S10 (30x30).

EN 1.4301 - AISI 304
Satinado | Satin

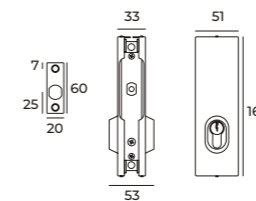

1 Un. 20 Un.

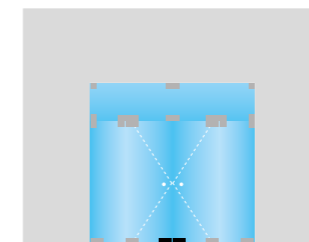

Q System for glass

Door strike box

IN.81.122 / Un.

Caixa testa para fechadura IN.81.121 / Strike box for lock IN.81.121 / Caja cerradero para cerradura IN.81.121.

EN 1.4301 - AISI 304
Satinado | Satin

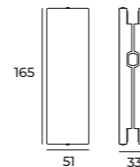

1 Un. 20 Un.

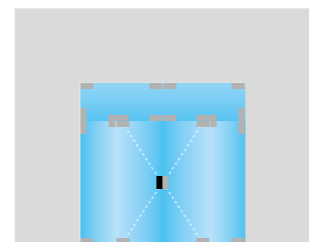

Q System for glass

Bottom door lock

IN.81.120.B / Un.

Fechadura com cilindro europeu S10 (30+30) / Lock with european cylinder S10 (30+30) / Cerradura con cilindro europeo S10 (30x30).

EN 1.4301 - AISI 304
Satinado | Satin

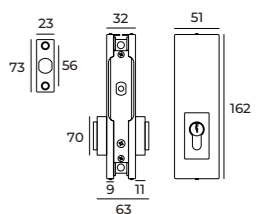

1 Un. 20 Un.

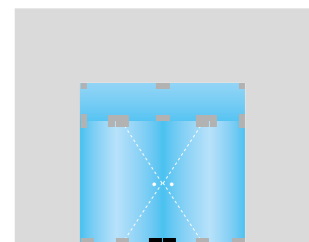



Q System for glass

Bolt with turning Knob

IN.81.118 / Un.

Trinco para vidro /
Glass bolt /
Cierre para cristal.

EN 1.4301 - AISI 304
Satinado | Satin

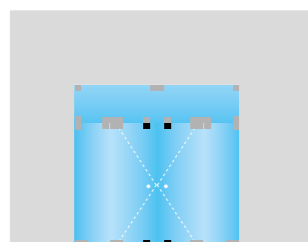
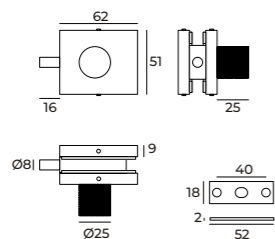

Q System for glass

Strike box

IN.81.119 / Un.

Testa para fecho IN.81.118 /
Strike box for glass bolt IN.81.118 /
Cerradero para cierre IN.81.118.

EN 1.4301 - AISI 304
Satinado | Satin

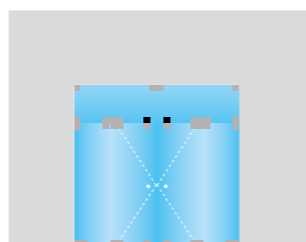
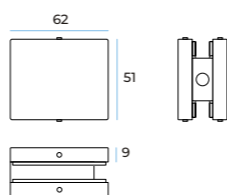

Q2 SYSTEM FOR GLASS

Q2 SYSTEM PARA VIDRO
Q2 SYSTEM PARA CRISTAL

- Aplicável em vidro de 10-12mm.
- Cilindro de construção 30+30 incluído.
- Compatível com a quadra 21.001.R.
- As peças podem ser cortadas em comprimento

- Suitable for 10-12mm glass.
- Building cylinder 30+30 included.
- Suitable for spindle 21.001.R
- Parts can be cut in length

- Aplicable en cristal de 10-12mm
- Cilindro de construcción 30+30 incluido
- Compatible con quadradillo 21.001.R
- Piezas se pueden cortar en anchura



Q2 System for glass Pivot door set

IN.81.400 (1000mm) / Set
IN.81.401 (1500mm) / Set

Conjunto de pivot superior e inferior para portas de vidro com fechadura e cilindro. Tampas de remate incluídas. Pode ser cortado. Quadra inferior e suporte de pivot superior não incluídos | Upper and bottom pivot kit for glass doors with lock and cylinder. Can be cut. Covers included. Lower spindle and upper pivot support not included | Conjunto de pivote superior y inferior para cristal con cerradura y cilindro. Puede ser cortado. Cubiertas incluidas. Quadradillo inferior y soporte de pivote superior no incluidos.

EN 1.4301 - AISI 304
Satinado | Satin

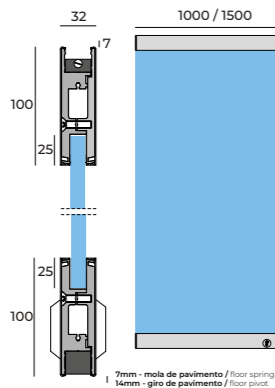

Q2 System for glass Lower pivot door

IN.81.403 (1000mm) / Set

Pivot inferior para portas de vidro com fechadura e cilindro. Tampas de remate incluídas. Pode ser cortado / Bottom pivot for glass doors with lock and cylinder. Can be cut. Covers included / Pivote inferior para cristal con cerradura y cilindro. Puede ser cortado. Cubiertas incluidas.

EN 1.4301 - AISI 304
Satinado | Satin

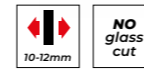
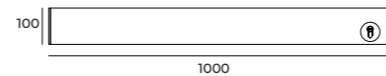

Q2 System for glass Fixed panel set

IN.81.402 (3000mm) / Set

Conjunto superior e inferior para vidro fixo. Tampas de remate incluídas. Pode ser cortado / Upper and bottom Kit for fixed glass. Can be cut. Covers included / Conjunto superior y inferior para cristal fijo. Puede ser cortado. Cubiertas incluidas.

EN 1.4301 - AISI 304
Satinado | Satin

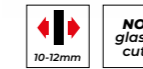
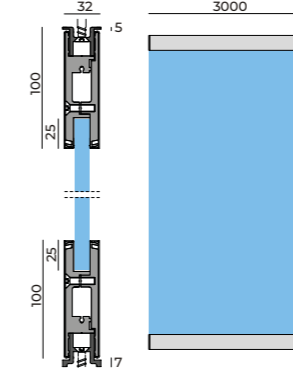

Q2 System for glass Lower fixed panel

IN.81.404 (3000mm) / Un.

Perfil inferior para vidro fixo. Pode ser cortado. Tampas de remate incluídas. Bottom profile for fixed glass. Can be cut. Covers included. / Perfil inferior para cristal fijo. Puede ser cortado. Cubiertas incluidas.

EN 1.4301 - AISI 304
Satinado | Satin

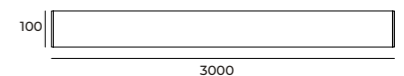

IN.81.405 / Par

Conjunto de 2 remates para perfil **IN.81.402/404** / Set of 2 end covers for IN.81.402/404 / Conjunto de 2 terminales para IN.81.402/404.



F SYSTEM FOR GLASS

F SYSTEM PARA VIDRO F SYSTEM PARA CRISTAL

Sistemas para construção de divisórias em vidro de 10 ou 12mm. Corpo em alumínio lacado. Tampas em aço inoxidável EN 1.4301. Sistema de encaixe rápido. Parafusos de fixação do vidro em ambos os lados.

Fixing system for 10 or 12mm glass panels. Body made in aluminum with lacquering finish. Covers made in stainless steel EN 1.4301. Fast plug system. Screws for fixing the glass on both sides.

Sistema de fijación de paneles de cristal con 10 o 12mm. Cuerpo fabricado en aluminio lacado. Cubiertas en acero inoxidable EN 1.4301. Sistema de encaje rápido. Tornillos de fijación del cristal en ambos lados.



F System for glass Bottom patch fitting

IN.81.001 / Un.

Giro inferior para vidro /
Bottom patch fitting /
Giro inferior para cristal.

EN 1.4301 - AISI 304
Satinado | Satin

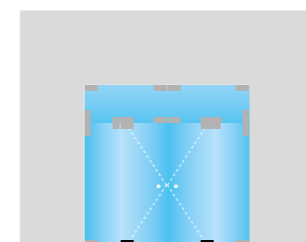
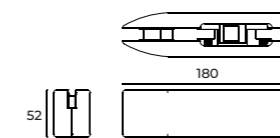

F System for glass Upper panel pivot

IN.81.002 / Un.

Giro superior de bandeira
para vidro |
Overhead panel pivot |
Pivot superior de bandera
para cristal.

EN 1.4301 - AISI 304
Satinado | Satin

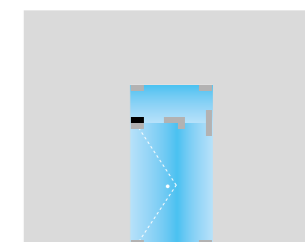
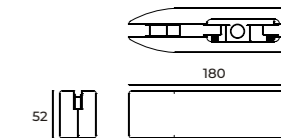



GC01
glass
cut

10-12mm

F System for glass

Upper patch fitting

IN.81.003 / Un.

*Giro superior para porta de vidro /
Upper door pivot /
Pivot superior para puerta
de cristal.*

EN 1.4301 - AISI 304
Satinado | Satin

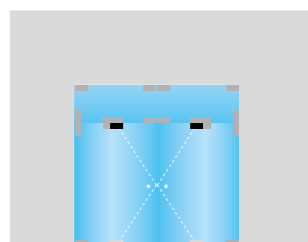
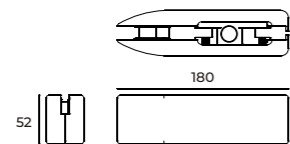

1 Un. 2 Un.



GC01
glass
cut

10-12mm

F System for glass

Glass support with stop

IN.81.006 / Un.

*Suporte superior com batente /
Top patch fitting with stopper /
Soporte superior con tope.*

EN 1.4301 - AISI 304
Satinado | Satin

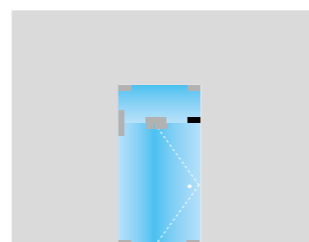
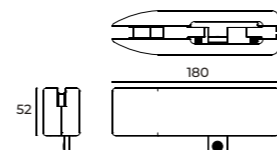

1 Un. 2 Un.



GC02
glass
cut

10-12mm

F System for glass

Side/upper pivot support

IN.81.004 / Un.

*Suporte de bandeira com giro /
Panel side support with pivot /
Soporte lateral de panel con pivote.*

EN 1.4301 - AISI 304
Satinado | Satin

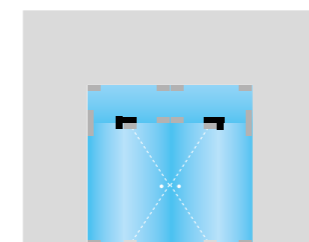
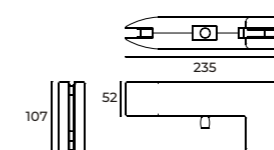

1 Un. 2 Un.



GC02
glass
cut

10-12mm

F System for glass

Side/upper stop support

IN.81.005 / Un.

*Suporte de bandeira com batente /
Panel side support with stopper /
Soporte lateral de panel con tope.*

EN 1.4301 - AISI 304
Satinado | Satin

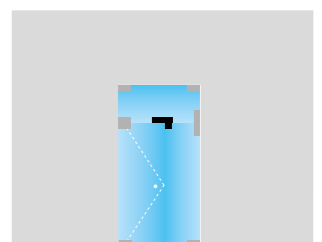
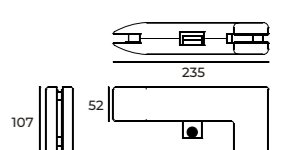

1 Un. 2 Un.



GC03
glass
cut

10-12mm

F System for glass

Double patch fitting

IN.81.008 / Un.

Suporte de vidro duplo /
Double patch fitting /
Soporte conector doble.

EN 1.4301 - AISI 304
Satinado | Satin

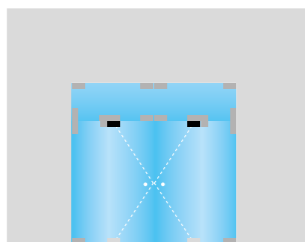
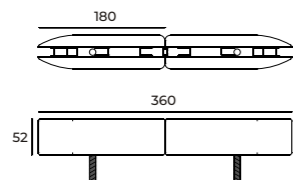

1 Un. 2 Un.



GC03
glass
cut

10-12mm

F System for glass

Double support w/ stop

IN.81.009 / Un.

Suporte superior duplo
com batente /
Double upper patch fitting
with stopper /
Soporte superior doble
con tope de puerta.

EN 1.4301 - AISI 304
Satinado | Satin

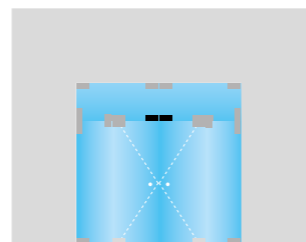
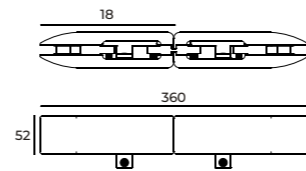

1 Un. 2 Un.



GC01
glass
cut

10-12mm

F System for glass

Corner patch fitting

IN.81.007 / Un.

Suporte de vidro de canto /
Corner patch fitting /
Sujeción de cristal de canto.

EN 1.4301 - AISI 304
Satinado | Satin

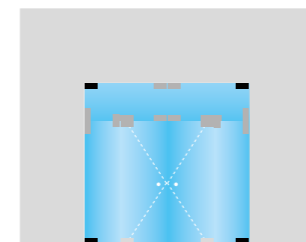
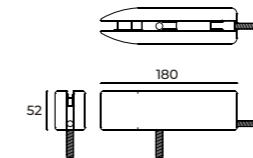

1 Un. 2 Un.



30x30

GC04
glass
cut

10-12mm

F System for glass

Lock for euro cylinder

IN.81.010 / Un.

Fechadura de pavimento para
cilindro europeu com escudete
de segurança. Cilindro (30+30)
não incluído /
Bottom lock for european cylinder
with security escutecheon.
Cylinder (30+30) not included /
Cerradura de suelo para cilindro
europeo con escudo de seguridad.
Cilindro (30+30) no incluido.

EN 1.4301 - AISI 304
Satinado | Satin

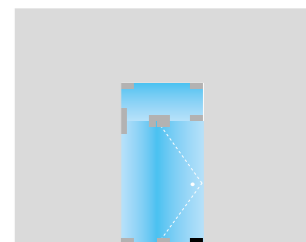
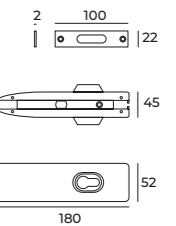

1 Un. 2 Un.

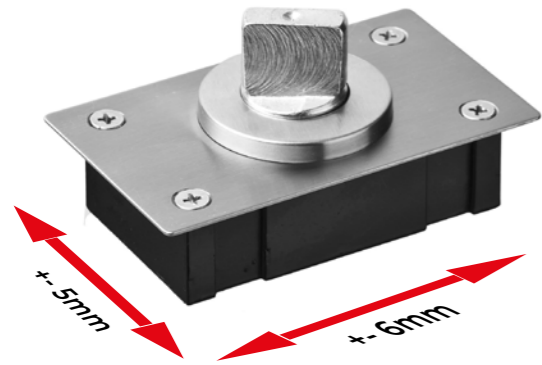

Free floor pivot 2D adjustment

IN.81.108 / Un.

Giro de pavimento ajustável /
Adjustable free floor pivot /
Pivote de pavimento ajustable.

A) Rolamento que garante um funcionamento suave e silencioso / Ball bearing that ensures a smooth and quiet function / Rodamiento que garantiza un movimiento suave y silencioso.

B) Quadra rectangular / Rectangular spindle / Cuadrado rectangular.

C) Ajustável em 2 eixos / Adjustable in 2 axes / Ajustable en 2 ejes.
(+/- 5mm | +/- 6mm)

EN 1.4301 - AISI 304
Satinado | Satin

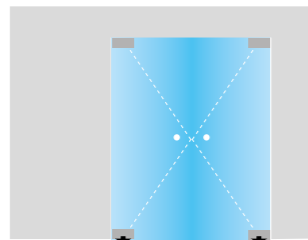
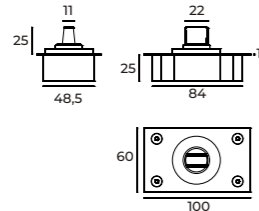

Free floor pivot Square spindle type

IN.81.105 / Un.

Giro de pavimento /
Floor pivot /
Pivote de pavimento.

EN 1.4301 - AISI 304
Satinado | Satin

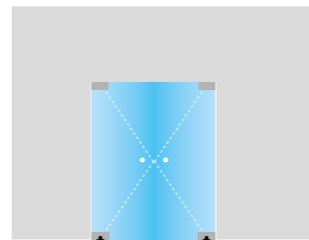
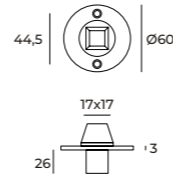

Ceiling pivot ø15 With base

IN.81.106.E / Un.

Pivot para tecto /
Ceiling pivot /
Pivote para techo.

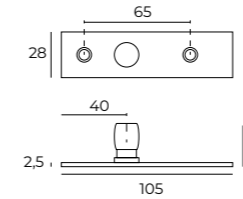

Stop for glass No cutout

IN.81.221.D / Un.

IN.81.221.E / Un.

Batente de porta para fixar no vidro /
Door stopper to use in upper glass /
Tope para usar en el cristal.

Latão niquelado /
Brass nickel | Latón níquel

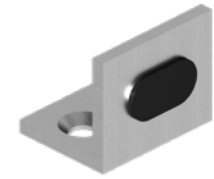
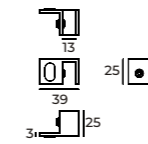

Stop L shape stopper

IN.81.222 / Un.

Batente de porta para fixar no aro, tecto, pavimento ou parede.
Door stopper to use in door frame, ceiling, floor or wall /
Tope para usar en el marco de la puerta, techo, suelo o pared.

Latão niquelado /
Brass nickel | Latón níquel

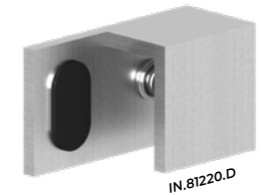
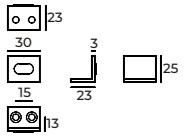

Stop for glass No cutout

IN.81.220.D / Un.

IN.81.220.E / Un.

Batente de porta para fixar no vidro /
Door stopper to use in upper glass /
Tope para usar en el cristal.

Latão niquelado /
Brass nickel | Latón níquel

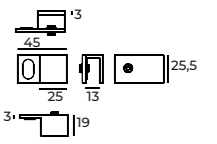

FLOOR CLOSER

MOLA DE PAVIMENTO
CIERRA PUERTAS



Floor door closer Power 3



21.2207 / Un.

Mola de pavimento para portas de batente ou vai-vém aplicável em portas de madeira, metálicas ou de vidro, com paragem a 90° /
Floor closer for single action doors or double action doors applicable to wooden, metal or glass doors with a hold open position at 90° /
Cierra puertas de suelo para puertas de batiente o doble acción, aplicable a puertas de madera, metálicas o de cristal con retención a 90°.



1 Un. 4 Un.



Com quadra 17x17mm fixa
With 17x17mm fixed spindle
Con cuadradillo 17x17mm fijo.

- Para portas com peso até 80kg;
- Velocidade ajustável por válvula hidráulicas desde os 130° aos 0°;
- Duas válvulas de ajuste para controlo independente da velocidade desde 130°-15° a 15°-0°;
- For doors with weight up to 80kg;
- Adjustable speed changeable through a hydraulic valve since 130° to 0°;
- Two independent valves of adjustment of latching speed controlling since 130°-15° to 15°-0°;
- Para puertas con peso hasta 80kg.
- Velocidad ajustable por válvula hidráulica desde 130° a 0°;
- Dos válvulas independientes para ajuste del cierre que controla la velocidad desde los 130°-15° hasta 15°-0°;

Aço inox
Stainless steel
Acero inox

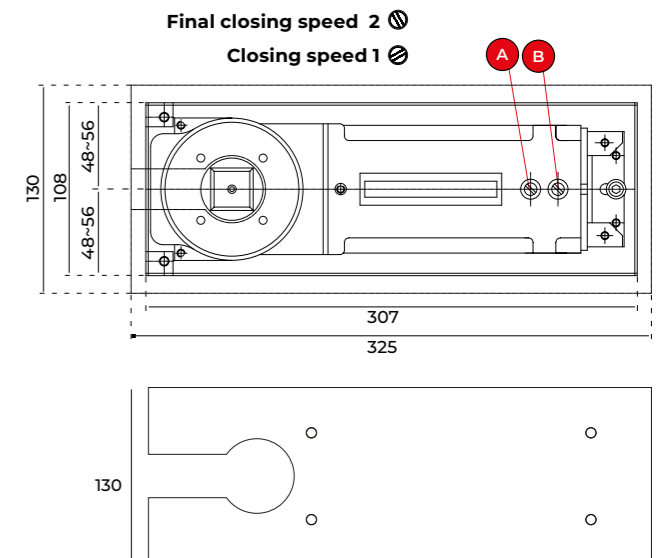
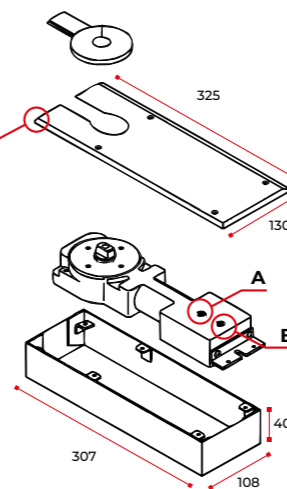
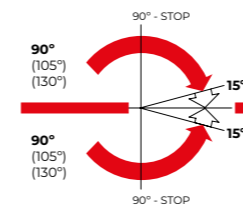



new

Floor door closer

Power 3



21.2265 / Un.

Mola de pavimento para portas de batente ou vai-vém aplicável em portas de madeira, metálicas ou de vidro, com paragem a 90° /
Floor closer for single action doors or double action doors applicable to wooden, metal or glass doors with a hold open position at 90° /
Cierra puertas de suelo para puertas de batiente o doble acción, aplicable a puertas de madera, metálicas o de cristal con retención a 90°.



1 Un. 4 Un.



Com quadra 17x17mm fixa
With 17x17mm fixed spindle
Con cuadradillo 17x17mm fijo.

- Para portas com peso até 100kg;
- Velocidade ajustável por válvula hidráulicas desde os 130° aos 0°;
- Duas válvulas de ajuste para controlo independente da velocidade desde 130°-15° a 15°-0°;

- For doors with weight up to 100kg;
- Adjustable speed changeable through a hydraulic valve since 130° to 0°;
- Two independent valves of adjustment of latching speed controlling since 130°-15° to 15°-0°;

- Para puertas con peso hasta 100kg.
- Velocidad ajustable por válvula hidráulica desde 130° a 0°;
- Dos válvulas independientes para ajuste del cierre que controla la velocidad desde los 130°-15° hasta 15°-0°;

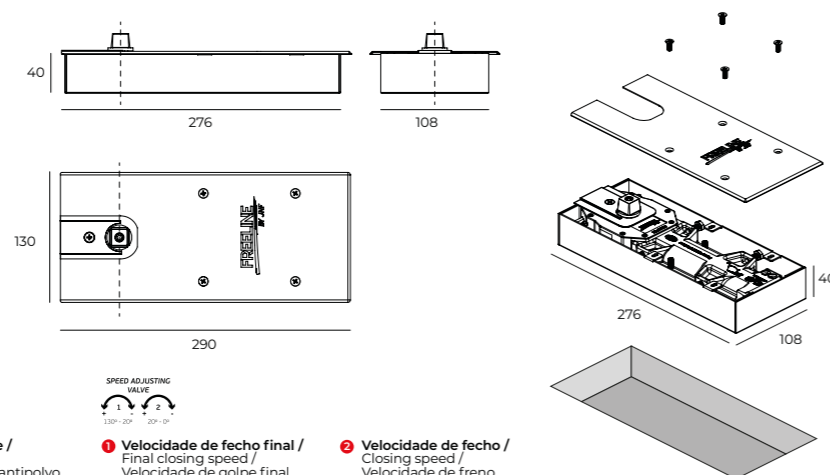

A Parafusos de ajuste de posição /
Position adjusting screws /
Tornillos de ajuste de posición.

B Parafusos de fixação da cobertura /
Cover fixing screws /
Tornillos de fijación de la cubierta.

C Parafuso de fixação de remate /
Dust proof cover screw /
Tornillo de fijación de cubierta antipolvo.



1 Velocidade de fecho final /
Final closing speed /
Velocidade de golpe final.

2 Velocidade de fecho /
Closing speed /
Velocidade de freno.



new

Floor door closer

Power 3



21.2266 / Un.

Mola de pavimento para portas de batente ou vai-vém aplicável em portas de madeira, metálicas ou de vidro, com paragem a 90° /
Floor closer for single action doors or double action doors applicable to wooden, metal or glass doors with a hold open position at 90° /
Cierra puertas de suelo para puertas de batiente o doble acción, aplicable a puertas de madera, metálicas o de cristal con retención a 90°.



1 Un. 4 Un.



Com quadra 22x11,6mm fixa
With 22x11,6mm fixed spindle
Con cuadradillo 22x11,6mm fijo.

- Para portas com peso até 100kg;
- Velocidade ajustável por válvula hidráulicas desde os 130° aos 0°;
- Duas válvulas de ajuste para controlo independente da velocidade desde 130°-15° a 15°-0°;

- For doors with weight up to 100kg;
- Adjustable speed changeable through a hydraulic valve since 130° to 0°;
- Two independent valves of adjustment of latching speed controlling since 130°-15° to 15°-0°;

- Para puertas con peso hasta 100kg.
- Velocidad ajustable por válvula hidráulica desde 130° a 0°;
- Dos válvulas independientes para ajuste del cierre que controla la velocidad desde los 130°-15° hasta 15°-0°;

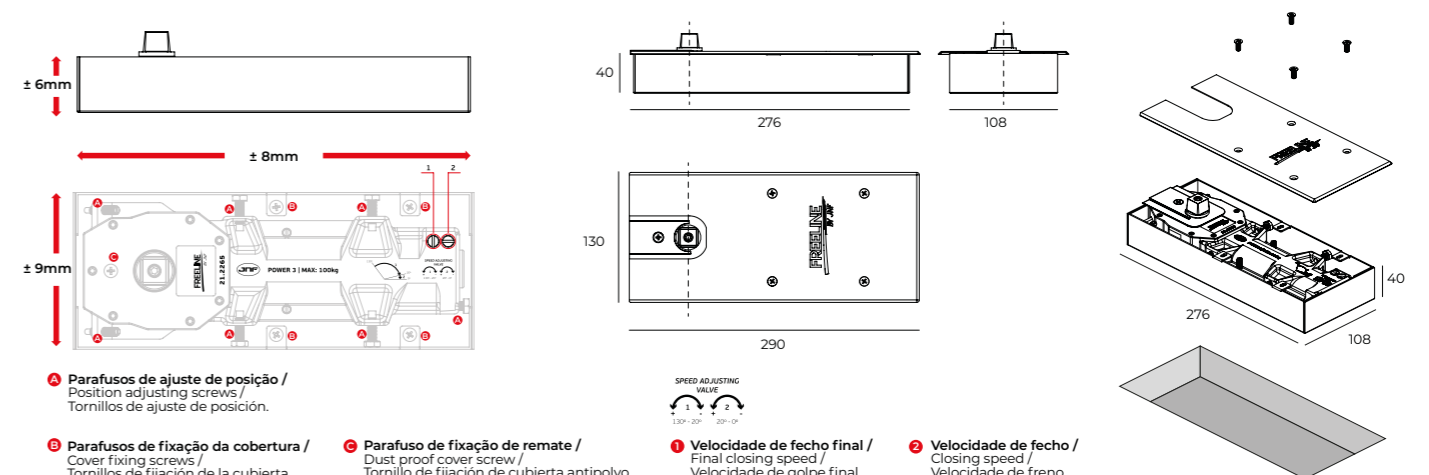

A Parafusos de ajuste de posição /
Position adjusting screws /
Tornillos de ajuste de posición.

B Parafusos de fixação da cobertura /
Cover fixing screws /
Tornillos de fijación de la cubierta.

C Parafuso de fixação de remate /
Dust proof cover screw /
Tornillo de fijación de cubierta antipolvo.



1 Velocidade de fecho final /
Final closing speed /
Velocidade de golpe final.

2 Velocidade de fecho /
Closing speed /
Velocidade de freno.



Glass lock

Cross key

IN.20.3000.1 / Un.

Fechadura para portas de vidro com cilindro chave de cruz /
Door lock for glass with cross key cylinder /
Cerradura para puertas de cristal con cilindro llave cruz.

EN 1.4301 - AISI 304
Satinado | Satin

IN.20.3000.2 / Set
IN.20.3000.3 / Set
IN.20.3000.4 / Set

Fechadura para portas de vidro com cilindro chave de cruz em grupos de chaves iguais /
Door lock for glass with cross key cylinder in key alike groups /
Cerradura para puertas de cristal con cilindro llave de cristal con cilindro llave

EN 1.4301 - AISI 304
Satinado | Satin

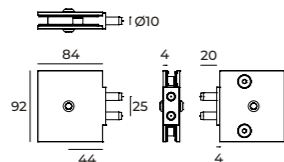

Glass lock

Strike box / plate

IN.20.3001 / Un.

Caixa testa para fechadura IN.20.3000 /
Strike box for lock IN.20.3000 /
Caja cerradero para cerradura IN.20.3000.

EN 1.4301 - AISI 304
Satinado | Satin

IN.20.3003 / Un.

Testa para fechadura IN.20.3000 /
Strike plate for lock IN.20.3000 /
Cerradero para cerradura IN.20.3000.

EN 1.4301 - AISI 304
Satinado | Satin

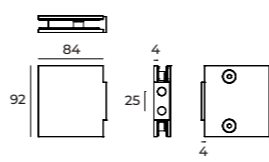

IN.20.3003



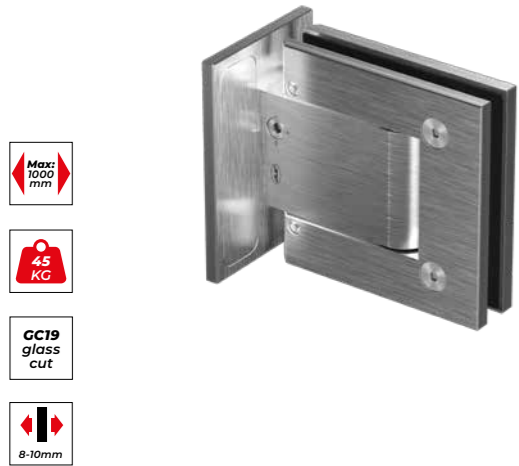

Hydraulic hinge - ALU

Self / soft closing hinge

IN.05.315.NS / Un.

Dobradiça hidráulica, parede - vidro /
Hydraulic glass to wall hinge /
Bisagra hidráulica pared - cristal.

Alumínio níquel satinado |
Aluminium satin nickel |
Aluminio níquel satinado.

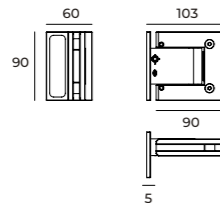

1 Un. 20 Un.



Shower hinge - Zamak

Wall to glass - centered

IN.05.330 / Un.

Dobradiça parede-vidro com paragem /
Wall to glass hinge with stop /
Bisagra pared-cristal con freno.

Zamak satinado |
Satin zinc alloy | *Zamak satinado*

IN.05.330.P / Un.

Dobradiça parede-vidro com paragem /
Wall to glass hinge with stop /
Bisagra pared-cristal con freno.

Zamak polido |
Polished zinc alloy | *Zamak pulido*



1 Un. 20 Un.

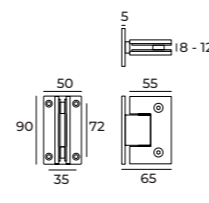

Shower hinge - Zamak

Wall to glass - offset

IN.05.331 / Un.

Dobradiça parede-vidro com paragem /
Wall to glass hinge with stop /
Bisagra pared-cristal con freno.

Zamak satinado |
Satin zinc alloy | *Zamak satinado*

IN.05.331.P / Un.

Dobradiça parede-vidro com paragem /
Wall to glass hinge with stop /
Bisagra pared-cristal con freno.

Zamak polido |
Polished zinc alloy | *Zamak pulido*



1 Un. 20 Un.

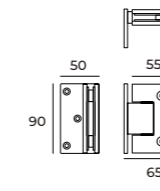

Shower hinge - Zamak

Glass to glass hinge

IN.05.332 / Un.

Dobradiça vidro-vidro com paragem /
Glass to glass hinge with stop /
Bisagra cristal-cristal con freno.

Zamak satinado |
Satin zinc alloy | *Zamak satinado*

IN.05.332.P / Un.

Dobradiça vidro-vidro com paragem /
Glass to glass hinge with stop /
Bisagra cristal-cristal con freno.

Zamak polido |
Polished zinc alloy | *Zamak pulido*



1 Un. 20 Un.

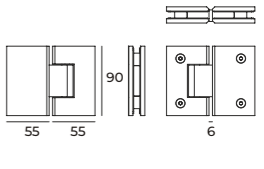



GC24
glass
cut



Shower support - Inox

Wall to glass

IN.05.305 / Un.

Suporte de parede-vidro /
Wall to glass support /
Soporte pared-cristal.

EN 1.4301 - AISI 304
Satinado | Satin

IN.05.305.P / Un.

Suporte de parede-vidro /
Wall to glass support /
Soporte pared-cristal.

EN 1.4301 - AISI 304
Polido | Polished | Pulido

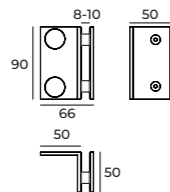

GC22
glass
cut



Shower hinge - Inox

Wall to glass - offset

IN.05.306 / Un.

Dobradiça parede-vidro com paragem /
Wall to glass hinge with stop /
Bisagra pared-cristal con freno.

EN 1.4301 - AISI 304
Satinado | Satin

IN.05.306.P / Un.

Dobradiça parede-vidro com paragem /
Wall to glass hinge with stop /
Bisagra pared-cristal con freno.

EN 1.4301 - AISI 304
Polido | Polished | Pulido

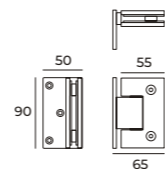

1 Un. 20 Un.



GC22
glass
cut



Shower hinge - Inox

Wall to glass - centered

IN.05.307 / Un.

Dobradiça parede-vidro com paragem /
Wall to glass hinge with stop /
Bisagra pared-cristal con freno.

EN 1.4301 - AISI 304
Satinado | Satin

IN.05.307.P / Un.

Dobradiça parede-vidro com paragem /
Wall to glass hinge with stop /
Bisagra pared-cristal con freno.

EN 1.4301 - AISI 304
Polido | Polished | Pulido

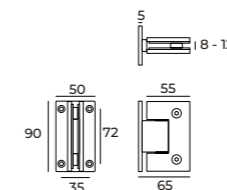

1 Un. 20 Un.



GC23
glass
cut



Shower hinge - Inox

Glass to glass 180°

IN.05.308 / Un.

Dobradiça vidro-vidro com paragem /
Glass to glass hinge with stop /
Bisagra cristal-cristal con freno.

EN 1.4301 - AISI 304
Satinado | Satin

IN.05.308.P / Un.

Dobradiça vidro-vidro com paragem /
Glass to glass hinge with stop /
Bisagra cristal-cristal con freno.

EN 1.4301 - AISI 304
Polido | Polished | Pulido

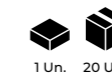
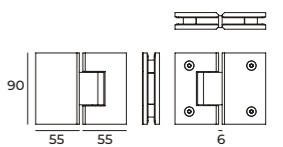

1 Un. 20 Un.



Shower hinge - Inox

Glass to glass 90°

IN.05.311 / Un.

Dobradiça vidro - vidro, 90° com paragem /
Glass to glass hinge with stop 90° /
Bisagra cristal - cristal 90° con freno.

EN 1.4301 - AISI 304
Satinado | Satin

IN.05.311.P / Un.

Dobradiça vidro - vidro, 90° com paragem /
Glass to glass hinge with stop 90° /
Bisagra cristal - cristal 90° con freno

EN 1.4301 - AISI 304
Polido | Polished | Pulido

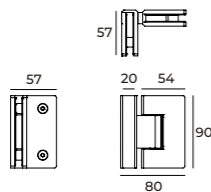

SHOWER HINGES

DOBRADIÇAS PARA CHUVEIRO
BISAGRAS PARA DUCHA

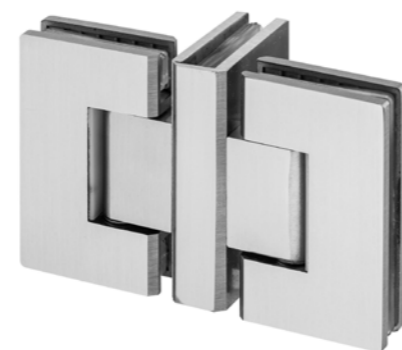

Double shower hinge

Glass to glass to glass

IN.05.308.D / Un.

Dobradiça dupla, vidro - vidro, 90° com paragem /
Glass to glass double hinge with stop 90° /
Bisagra doble - cristal - cristal 90° con freno.

EN 1.4301 - AISI 304
Satinado | Satin

IN.05.308.D.P / Un.

Dobradiça dupla, vidro - vidro, 90° com paragem /
Glass to glass double hinge with stop 90° /
Bisagra doble - cristal - cristal 90° con freno

EN 1.4301 - AISI 304
Polido | Polished | Pulido

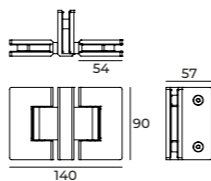



GC24
glass
cut

8-10mm

Shower support Black

Wall to glass

IN.05.305.TB / Un.

Suporte de parede-vidro /
Wall to glass support /
Soporte pared-cristal.

EN 1.4301 - AISI 304 + PVD TITANIUM BLACK
Satinado | Satin

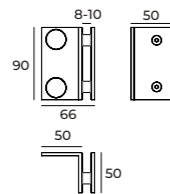

1 Un. 20 Un.



Max
1000
mm

45
KG

GC22
glass
cut

8-10mm

Shower hinge Black

Wall to glass

IN.05.306.TB / Un.

Dobradiça parede-vidro com paragem /
Wall to glass hinge with stop /
Bisagra pared-cristal con freno.

EN 1.4301 - AISI 304 + PVD TITANIUM BLACK
Satinado | Satin

IN.05.307.TB / Un.

Dobradiça parede-vidro com paragem /
Wall to glass hinge with stop /
Bisagra pared-cristal con freno.

EN 1.4301 - AISI 304 + PVD TITANIUM BLACK
Satinado | Satin

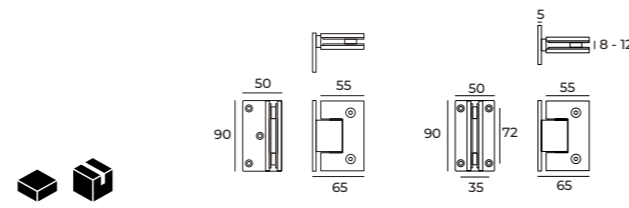

1 Un. 20 Un.

1 Un. 20 Un.



Max
1000
mm

45
KG

GC23
glass
cut

8-10mm

Shower hinge Black

Glass to glass 180°

IN.05.308.TB / Un.

Dobradiça vidro-vidro com paragem /
Glass to glass hinge with stop /
Bisagra cristal-cristal con freno.

EN 1.4301 - AISI 304 + PVD TITANIUM BLACK
Satinado | Satin

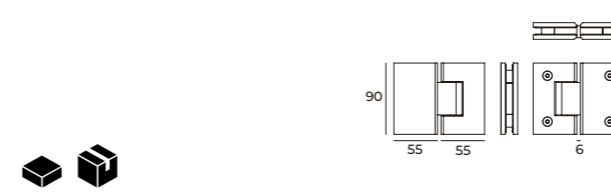

1 Un. 20 Un.

1 Un. 20 Un.



Max
1000
mm

45
KG

GC115
glass
cut

8-10mm

Shower hinge Black

Glass to glass 90°

IN.05.311.TB / Un.

Dobradiça vidro - vidro, 90° com paragem /
Glass to glass hinge with stop 90° /
Bisagra cristal - cristal 90° con freno.

EN 1.4301 - AISI 304 + PVD TITANIUM BLACK
Satinado | Satin

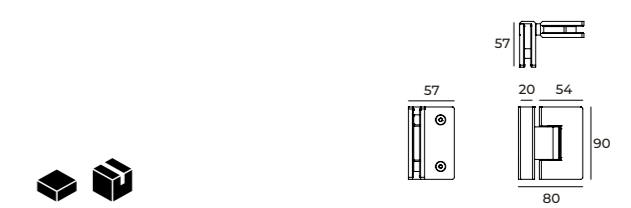

1 Un. 20 Un.

1 Un. 20 Un.



Office hinge - Satin

Profile to glass

IN.05.302 / Un.

Dobradiça parede - vidro /
Wall to glass hinge /
Bisagra pared - cristal.

EN 1.4301 - AISI 304
Satinado | Satin

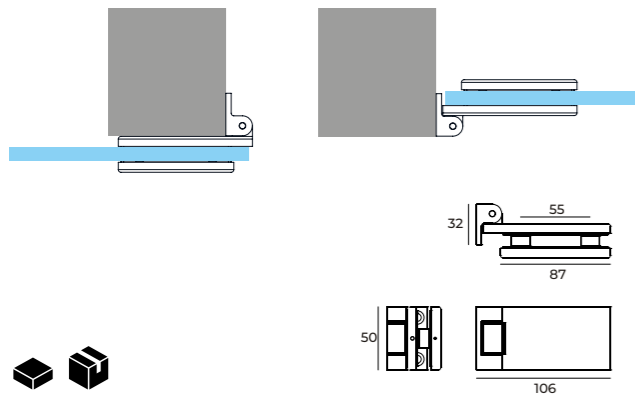

Aluminium hinges

with offset plate

IN.05.300.AL / Un.

Dobradiça para portas de vidro /
Hinge for glass doors /
Bisagra para puertas de cristal.

Alumínio | Aluminium

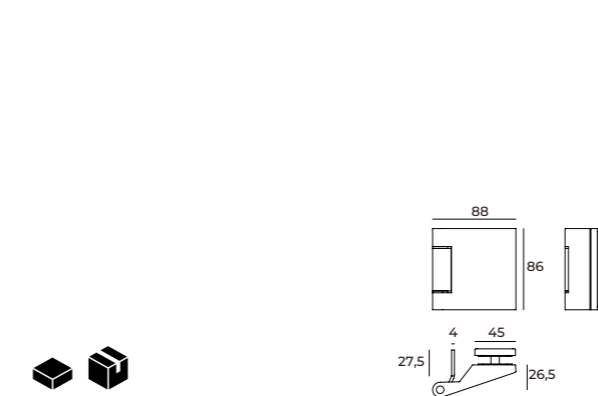

1 Un. 20 Un.



Office hinge - Polished

Profile to glass

IN.05.302.P / Un.

Dobradiça parede - vidro /
Wall to glass hinge /
Bisagra pared - cristal.

EN 1.4301 - AISI 304
Polida | Mirror polished | Pulido

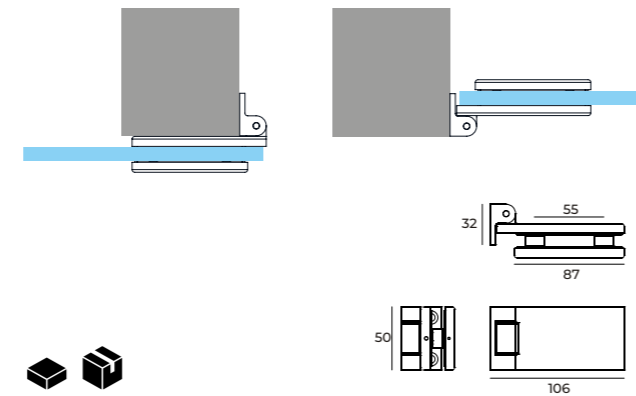

1 Un. 20 Un.



Aluminium hinges

Screw in

IN.05.301 / Un.

Dobradiça para portas de vidro /
Hinge for glass doors /
Bisagra para puertas de cristal.

EN 1.4301 - AISI 304
Satinado | Satin

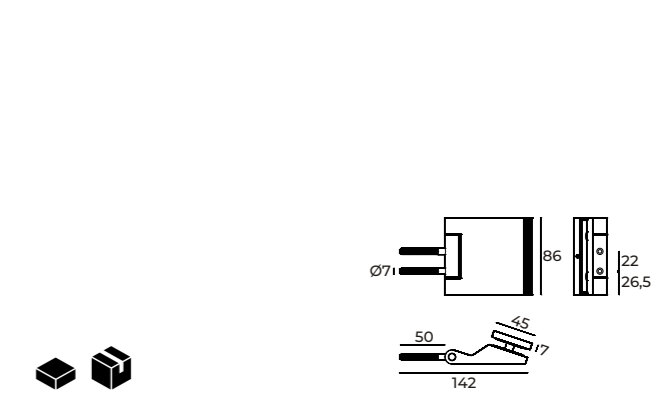

1 Un. 20 Un.



Spider glass hinge

Wall to glass

IN.75.010 / Un.

Dobradiça parede-vidro /
Wall to glass hinge /
Bisagra pared-cristal.

EN 1.4301 - AISI 304
Satinado | Satin

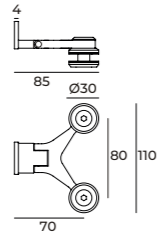

1 Un. 10 Un.



Spider glass support

Wall to glass

IN.75.013 / Un.

Suporte parede-vidro /
Wall to glass support /
Soporte pared-cristal.

EN 1.4301 - AISI 304
Satinado | Satin

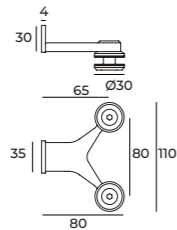

1 Un. 10 Un.



Spider glass hinge

Glass to glass

IN.75.011 / Un.

Dobradiça vidro-vidro /
Glass to glass hinge /
Bisagra cristal-cristal.

EN 1.4301 - AISI 304
Satinado | Satin

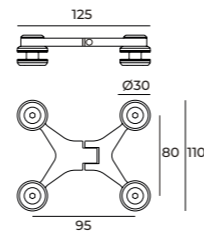

1 Un. 10 Un.

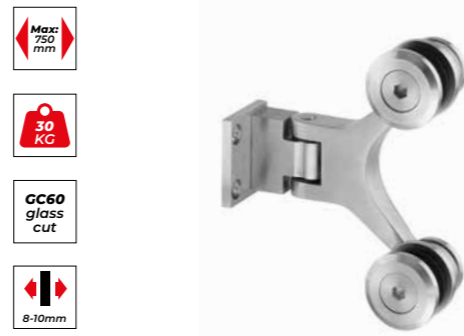

Spring spider hinge

Wall to glass

IN.75.110 / Un.

Dobradiça para vidro com mola e
paragem a 90° / Hinge for glass with
spring and stop at 90° / Bisagra para
cristal con muelle y freno a 90°.

EN 1.4301 - AISI 304
Satinado | Satin

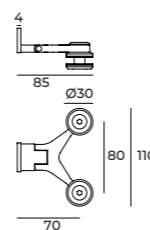

1 Un. 10 Un.



Glass support

Wall / Floor to glass

IN.75.250 / Un.

Suporte parede - vidro /
Wall - glass connector /
Soporte pared - cristal.

EN 1.4301 - AISI 304
Satinado | Satin

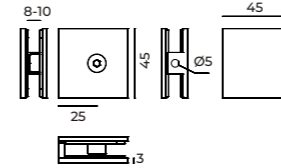

1 Un. 20 Un.



Glass support 90°

Glass to glass

IN.75.252 / Un.

Suporte vidro - vidro /
Glass - glass connector /
Soporte cristal - cristal.

EN 1.4301 - AISI 304
Satinado | Satin

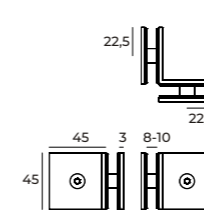

1 Un. 20 Un.



Glass support 90°

Wall / Floor to glass

IN.75.251 / Un.

Suporte parede - vidro /
Wall - glass connector /
Soporte pared - cristal.

EN 1.4301 - AISI 304
Satinado | Satin

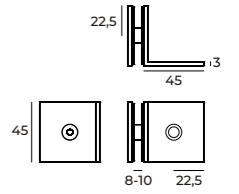

1 Un. 20 Un.



Glass support 180°

Glass to glass

IN.75.253 / Un.

Suporte vidro - vidro /
Glass - glass connector /
Soporte cristal - cristal.

EN 1.4301 - AISI 304
Satinado | Satin

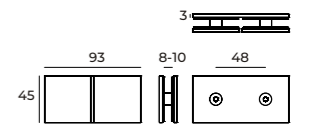

1 Un. 20 Un.



NO
glass
cut

10mm

Clip on profile

No cutout

IN.81.420 (3000mm) / Un.

Perfil para vidro fixo. Sistema de fixação sem furar o vidro.
Pode ser cortado. Podem ser feitos cortes a 45° /
Profile for fixed glass. Fixing system without drill the glass.
Can be cut. Can be cut at 45° /
Perfil para cristal fijo. Sistema de fijación sin taladrar el cristal.
Puede ser cortado. Puede ser cortado a 45°.

EN 1.4301 AISI 304
Satinado | Satin

IN.81.420.1 / Un.

Conjunto de 2 remates para perfil IN.81.420 (para colar) /
Set of 2 end covers for IN.81.420 (to glue) /
Conjunto de 2 terminales para IN.81.420 (para pegar).

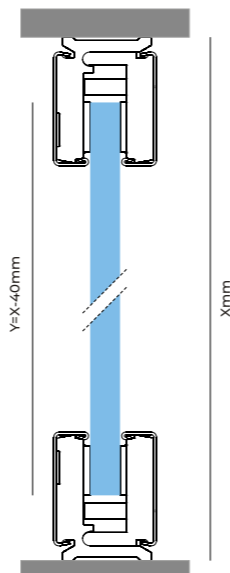
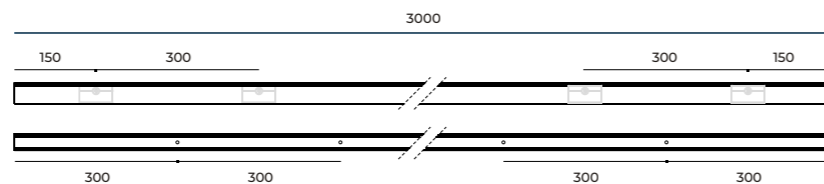

U shape profiles

Aluminium - Inox color

SM.101.AL.3000 / Un.
SM.101.AL.6000 / Un.

Perfil em "U" para painel ou vidro até 13 mm /
"U" shape profile until 13mm panel or glass /
Perfil en "U" para panel o cristal de 13mm.

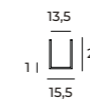

SM.102.AL / Un.

Perfil em "U" para painel ou vidro de 10mm /
"U" shape profile for 10mm panel or glass /
Perfil en "U" para panel o cristal de 10mm.



SM.104.AL / Un.

Perfil em "U" para painel ou vidro de 10mm /
"U" shape profile for 10mm panel or glass /
Perfil en "U" para panel o cristal de 10mm.



1 Un. 10 Un.



40
KG

CC86
glass
cut

10-12mm

Glass support - Satin

Floor / Wall to glass

IN.80.307 / Un.

Suporte pavimento ou tecto - vidro /
Ground or ceiling - glass connector /
Soporte suelo o techo - cristal.

EN 1.4401 AISI 316
Satinado | Satin

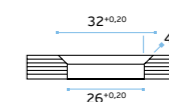

1 Un. 10 Un.

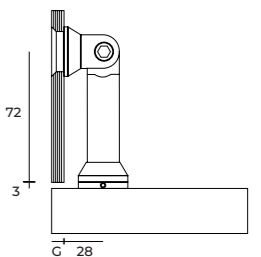

G Espessura do vidro
Glass thickness / Espesor del cristal

GC122
glass
cut



Cylinder

Double flush handle

IN.16.531 / Par

Concha dupla para vidro /
Double flush handle for glass /
Cazoleta doble para cristal.

EN 1.4301 - AISI 304
Satinado | Satin

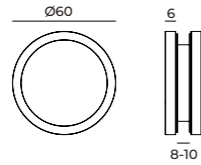

1 Pr. 10 Pr.

GC116
glass
cut



Rectangular

Double flush handle

IN.16.530 / Par

Concha dupla para vidro /
Double flush handle for glass /
Cazoleta doble para cristal.

EN 1.4301 - AISI 304
Satinado | Satin

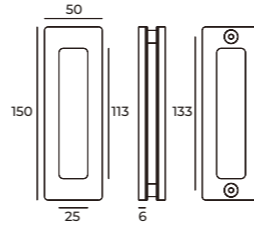

1 Pr. 10 Pr.

GC122
glass
cut



Combine

Double flush handle

IN.16.525 / Par

Concha dupla para vidro /
Double flush handle for glass /
Cazoleta doble para cristal.

EN 1.4301 - AISI 304
Satinado | Satin

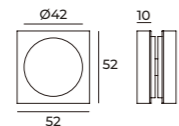

1 Pr. 20 Pr.

GC123
glass
cut



Square

Double flush handle

IN.16.529 / Par

Concha dupla para vidro /
Double flush handle for glass /
Cazoleta doble para cristal.

EN 1.4301 - AISI 304
Satinado | Satin

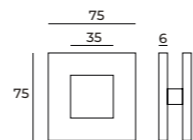

1 Pr. 10 Pr.



Pad knob

Double for glass

IN.00.096.V / Par

Puxador duplo para portas de vidro /
Double knob for glass doors /
Pomo doble para puertas de cristal.

EN 1.4301 - AISI 304
Satinado | Satin

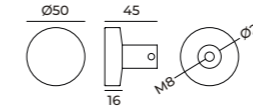

1 Pr. 24 Pr.



Cylinder knob

Double for glass

IN.00.097.V / Par

Puxador duplo para portas de vidro /
Double knob for glass doors /
Pomo doble para puertas de cristal.

EN 1.4301 - AISI 304
Satinado | Satin

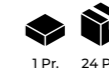
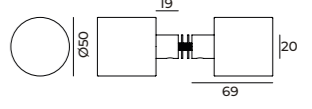

1 Pr. 24 Pr.



Ball knob

Double for glass

IN.00.095.V / Par

Puxador duplo para portas de vidro /
Double knob for glass doors /
Pomo doble para puertas de cristal.

EN 1.4301 - AISI 304
Satinado | Satin

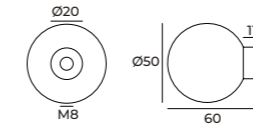

1 Pr. 24 Pr.



Finger knob

Double for glass

IN.75.030 / Par

Puxador duplo para portas de vidro /
Double knob for glass doors /
Pomo doble para puertas de cristal.

EN 1.4301 - AISI 304
Satinado | Satin

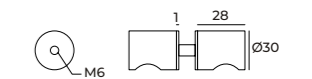

1 Pr. 24 Pr.

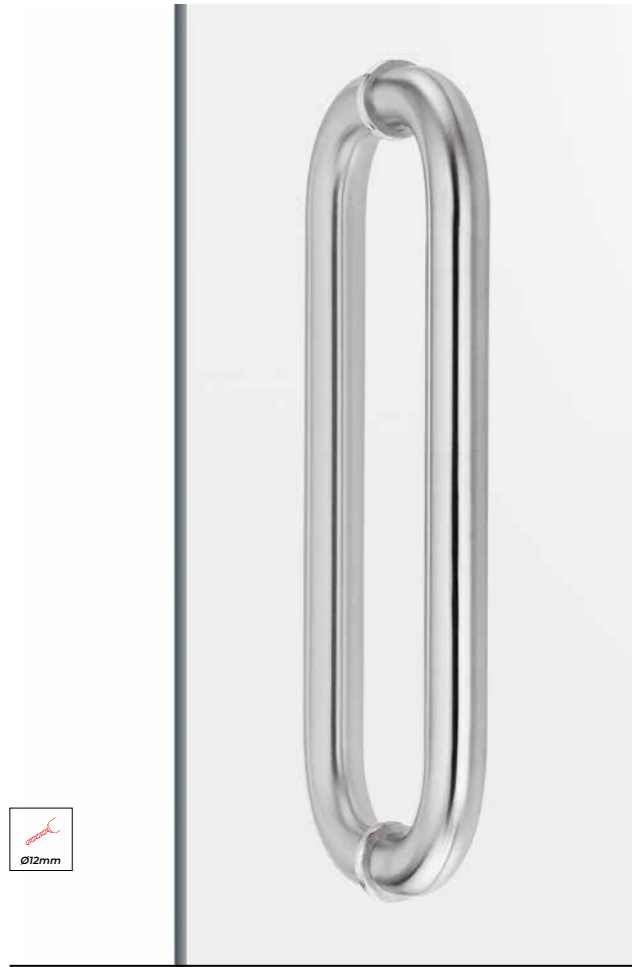

Pull handle 025 for glass cc300

IN.07.020.A / Par

Asa de porta dupla para vidro |
Double pull handle for glass door |
Manillone de puerta doble para cristal.

EN 1.4301 - AISI 304
Satinado | Satin

TUBULAR

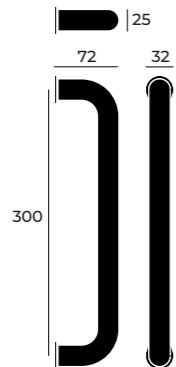

IN.07.020.A.TB / Par

EN 1.4301 - AISI 304
PVD TITANIUM Black



IN.07.020.A.TG / Par

EN 1.4301 - AISI 304
PVD TITANIUM Gold

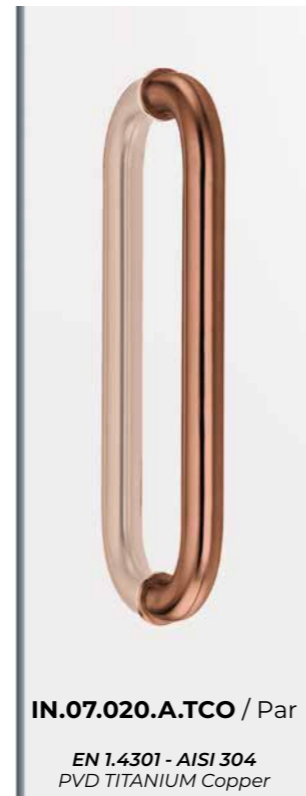

IN.07.020.A.TCO / Par

EN 1.4301 - AISI 304
PVD TITANIUM Copper



IN.07.020.A.P / Par

EN 1.4301 - AISI 304
Polida / Polished / Pulida



Pull handle 019 for glass cc200

IN.07.205.A.19.200 / Par

Asa de porta dupla para vidro |
Double pull handle for glass door |
Manillone de puerta doble para cristal.

EN 1.4301 - AISI 304
Satinado | Satin

TUBULAR



Pull handle 019 for glass cc250

IN.07.205.A.19.250 / Par

Asa de porta dupla para vidro |
Double pull handle for glass door |
Manillone de puerta doble para cristal.

EN 1.4301 - AISI 304
Satinado | Satin

TUBULAR

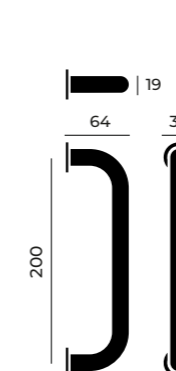



Pull handle 019 for glass cc160

IN.07.286.A.19.160 / Par

Asa de porta dupla para vidro |
Double pull handle for glass door |
Manillone de puerta doble para cristal.

EN 1.4301 - AISI 304
Satinado | Satin

TUBULAR

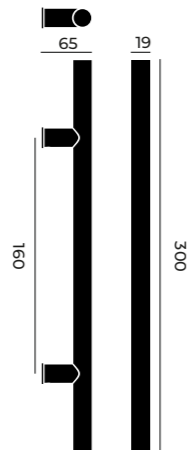

Pull handle 025 for glass cc300

IN.07.286.A.25.300 / Par

Asa de porta dupla para vidro |
Double pull handle for glass door |
Manillone de puerta doble para cristal.

EN 1.4301 - AISI 304
Satinado | Satin

TUBULAR

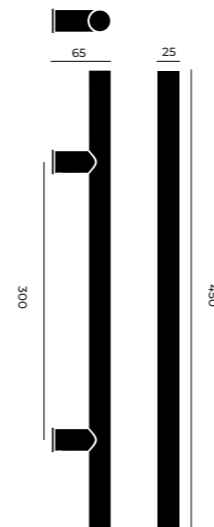

Pull handle 019 for glass cc250

IN.07.204.A / Par

Asa de porta dupla para vidro |
Double pull handle for glass door |
Manillone de puerta doble para cristal.

EN 1.4301 - AISI 304
Satinado | Satin

SEMI SOLID

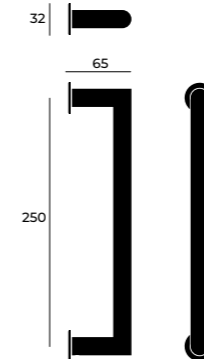

Pull handle 025 for glass cc600

IN.07.294 / Par

Asa de porta dupla para vidro |
Double pull handle for glass door |
Manillone de puerta doble para cristal.

EN 1.4301 - AISI 304
Satinado | Satin

TUBULAR

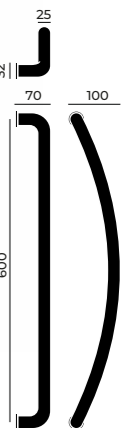

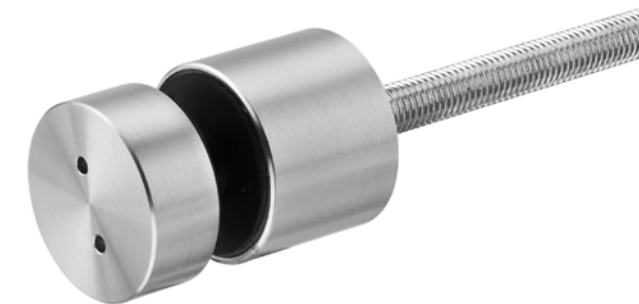

Standoff system ø50 AISI 316

IN.80.110 / Un.

Suporte para vidro.
Fixação à parede /
Glass support wall fixing /
Soporte para cristal.
Sujección a pared.

EN 1.4401 - AISI 316
Satinado | Satin

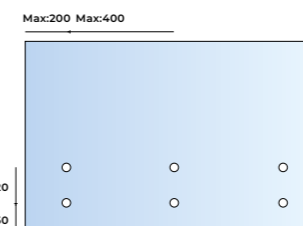
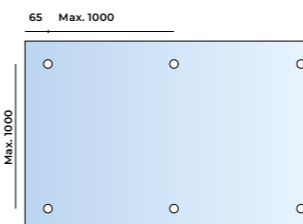
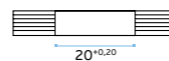
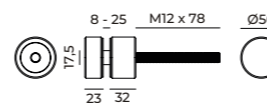

Standoff system ø38 AISI 304

IN.80.090 / Un.

Suporte para vidro.
Fixação à parede /
Glass support wall fixing /
Soporte para cristal.
Sujección a pared.

EN 1.4301 - AISI 304
Satinado | Satin

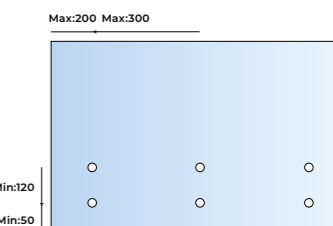
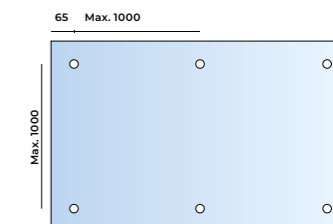
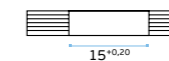
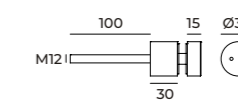



Standoff system $\varnothing 25$ AISI 304 - Solid

IN.80.105.30 / Un.
IN.80.105.35 / Un.
IN.80.105.40 / Un.

Suporte para vidro.
Fixação à parede /
Glass support wall fixing /
Soporte para cristal.
Sujección a pared.

EN 1.4301 - AISI 304
Satinado | Satin

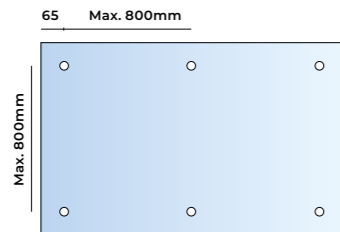
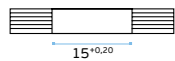
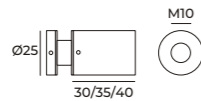

Standoff system AISI 304 - Hollow

IN.80.091.32 / Un.
IN.80.091.25 / Un.
IN.80.091.19 / Un.

Suporte para vidro.
Fixação à parede /
Glass support wall fixing /
Soporte para cristal.
Sujección a pared.

EN 1.4301 - AISI 304
Satinado | Satin

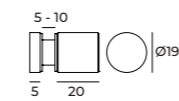
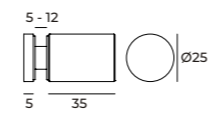
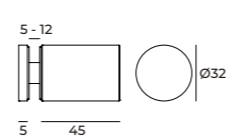

4 Un. 40 Un.





Glass clamp Solid Square

IN.80.203 / Un.



Suporte para vidro para tubo 42,4mm /
Glass clamp for tube 42,4mm / Soporte para cristal
para tubo 42,4mm. EN 1.4301 - AISI 304 Satinado | Satin



10 Un. 50 Un.

IN.80.204 / Un.



Suporte para vidro. Fixação à parede /
Glass support wall fixing / Soporte para cristal.
Sujeción a pared. EN 1.4301 - AISI 304 Satinado | Satin



10 Un. 50 Un.

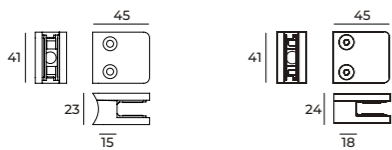

Glass clamp Solid Rounded

IN.80.103 / Un.



Suporte para vidro para tubo 42,4mm /
Glass clamp for tube 42,4mm / Soporte para cristal
para tubo 42,4mm. EN 1.4301 - AISI 304 Satinado | Satin



10 Un. 50 Un.

IN.80.104 / Un.



Suporte para vidro. Fixação à parede /
Glass support wall fixing / Soporte para cristal.
Sujeción a pared. EN 1.4301 - AISI 304 Satinado | Satin



10 Un. 50 Un.

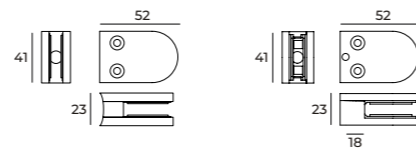

Glass clamp Stamped series

IN.80.130 / Un.



Suporte para vidro. Fixação à parede /
Glass support wall fixing / Soporte para cristal.
Sujeción a pared. EN 1.4301 - AISI 304 Satinado | Satin



30 Un. 180 Un.

IN.80.131 / Un.



Suporte para vidro. Fixação à parede /
Glass support wall fixing / Soporte para cristal.
Sujeción a pared. EN 1.4301 - AISI 304 Satinado | Satin



15 Un. 150 Un.

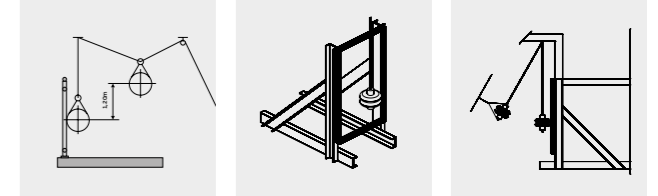
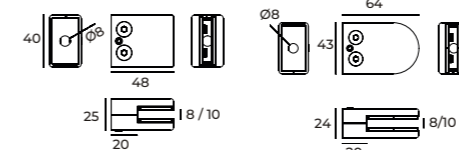

ENSAIOS DINÂMICOS, DE ACORDO COM AS NORMAS NP
4491:2009 - PT (PONTOS 5.2 E 5.3) E EN12600 (PONTO 5.1), DE
FORMA A GARANTIR A RESISTÊNCIA ADEQUADA.

MASSA DE CORPO MOLE: 50KG ± 0.5KG.

Grav 1:

- Utilização em interiores, proteção mínima ao impacto
- Peso largado a H:190mm
- Energia de choque 95J

DYNAMIC TESTS ACCORDING TO STANDARDS EN12600
(SECTION 5.1) AND NP 4491:2009 - PT (SECTION 5.2 E 5.3), TO
ENSURE THE ADEQUATE STRENGTH.

MASS OF DEAD BODY: 50KG ± 0.5KG.

Grade 1:

- Indoor use, minimal protection to impact
- Dropped weight at H:190mm
- Shock energy 95J

PRUEBAS DINÁMICAS, DE ACUERDO CON LAS NORMAS
EN12600 (PUNTO 5.1) Y NP 4491:2009 - PT (PUNTOS 5.2 E 5.3),
PARA GARANTIZAR LA RESISTENCIA ADECUADA.

MASA DE CUERPO BLANDO: 50 KG ± 0.5KG.

Grado 1:

- Uso interior, protección mínima al impacto
- Peso caído a H:190mm
- Energía de choque 95J



Pinças para vidro sem pino e sem placa de segurança /
Glass clamp without safety pin and plate /
Soporte de cristal sin pino y placa de seguridad.



GC65
glass
cut

6-10
mm



Lock for glass

IN.20.07715 / Un.

Fechadura com cilindro amovível para vidro /
Lock with removable cylinder for glass /
Cerradura con cilindro amovible para cristal.

1 Un. 10 Un.

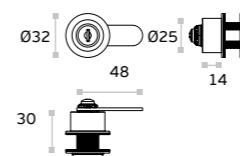

Strike plate for lock



20.4003 / Un.

Chapa testa para fechadura 20.4000 /
Strike plate for lock 20.4000 /
Cerradero para cerradura 20.4000.

12 Un. 60 Un.

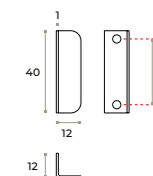

Technical keys for 07715

07715.CM / Un.

Chave mestra /
Master key /
Llave mestra.

1 Un.

07715.CR / Un.

Chave para remoção do
cilindro / Cylinder changing key /
Llave para quitar el cilindro.



Cylinder Removable

07715.C / Un.

Cilindro amovível para fechadura IN.20.07715 /
Removable cylinder for lock IN.20.07715 /
Cilindro amovible para cerradura IN.20.07715.

1 Un. 12 Un.

Vacuum glass holder Triple Max. 100kg.

IN.81.VNT / Un.

Pega tripla de vacuo para transportar vidro ou materiais com
superfícies lisas e limpas. Máximo: 100kg /
Triple vacuum glass holder to carry glass or material with smooth
and clean surfaces. Max: 100kg /
Asa triple de vacio para transportar cristal o materiales con
superfícies lisas y limpias. Máximo: 100 kg.



1 Un. 5 Un.

GC65
glass
cut

6-10
mm



Lock for glass

IN.20.07715.Q / Un.

Fechadura com cilindro amovível para vidro /
Lock with removable cylinder for glass /
Cerradura con cilindro amovible para cristal.

1 Un. 10 Un.

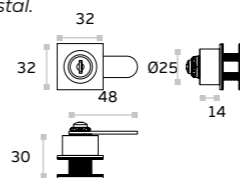

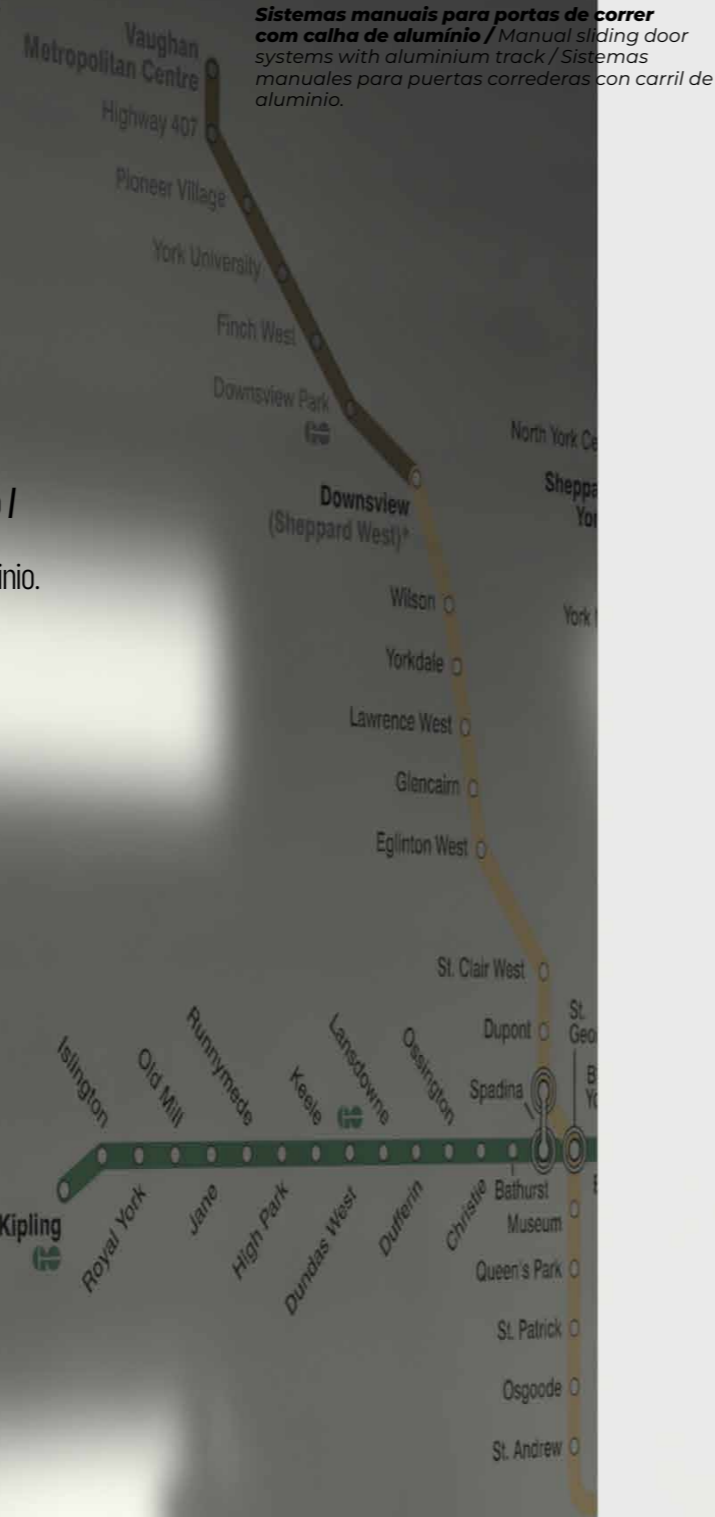

Sistemas manuais para portas de correr com calha de alumínio / Manual sliding door systems with aluminium track / Sistemas manuales para puertas correderas con carril de aluminio.

K60 / K110 for glass sliding doors

Sistemas manuais para portas de correr com calha de alumínio /
Manual sliding door systems with aluminium track /
Sistemas manuales para puertas correderas con carril de aluminio.



Sistemas manuais para portas de correr com calha de alumínio / Manual sliding door systems with aluminium track / Sistemas manuales para puertas correderas con carril de aluminio.

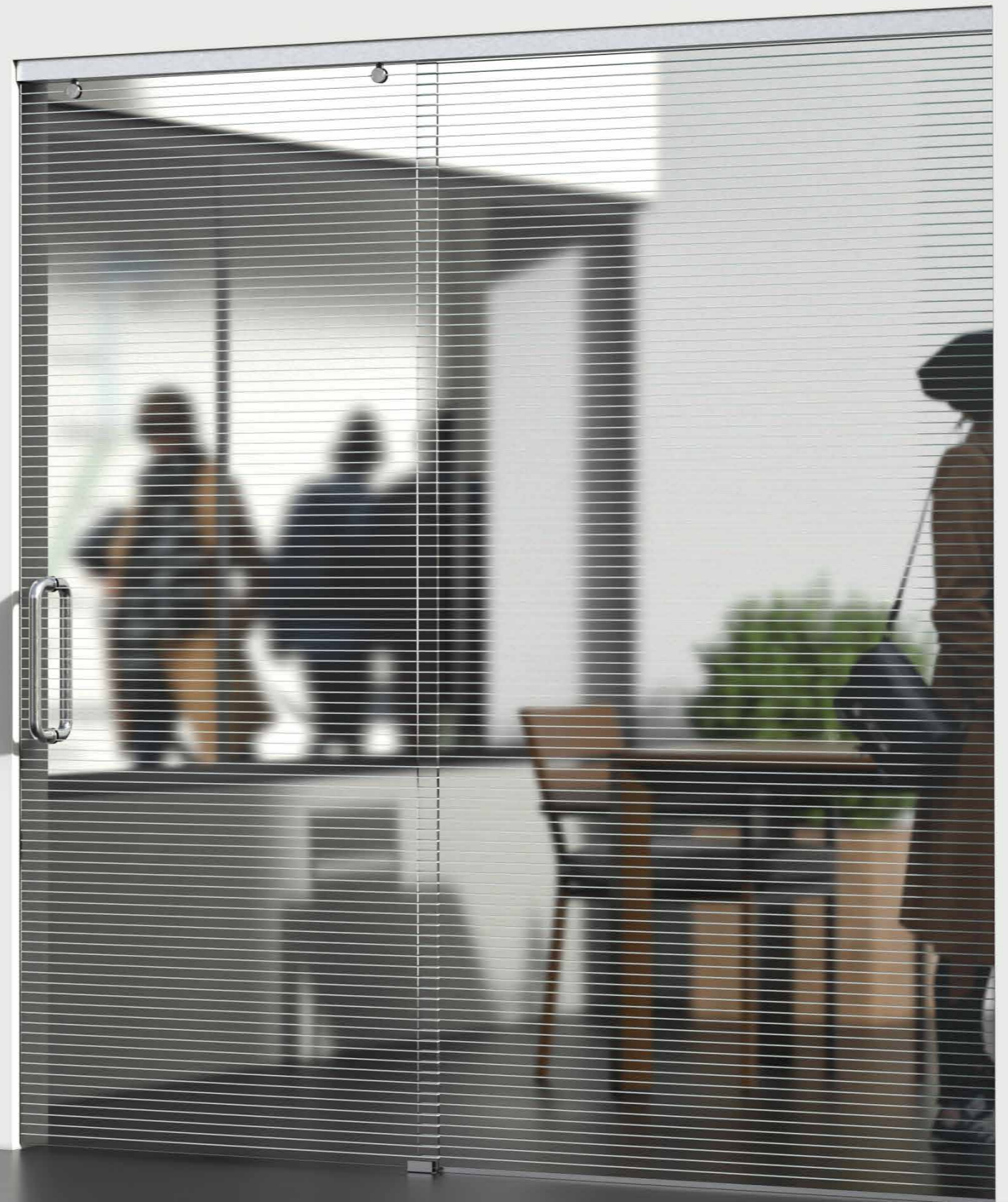

K60

Sliding door system for glass with soft closing

Sistema de porta de correr de vidro com fecho suave.
Sliding door system for glass with soft closing.
Sistema de puerta corredera de cristal con cierre suave.



SOFT CLOSING

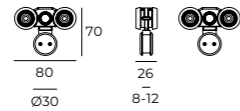

SOFT CLOSING

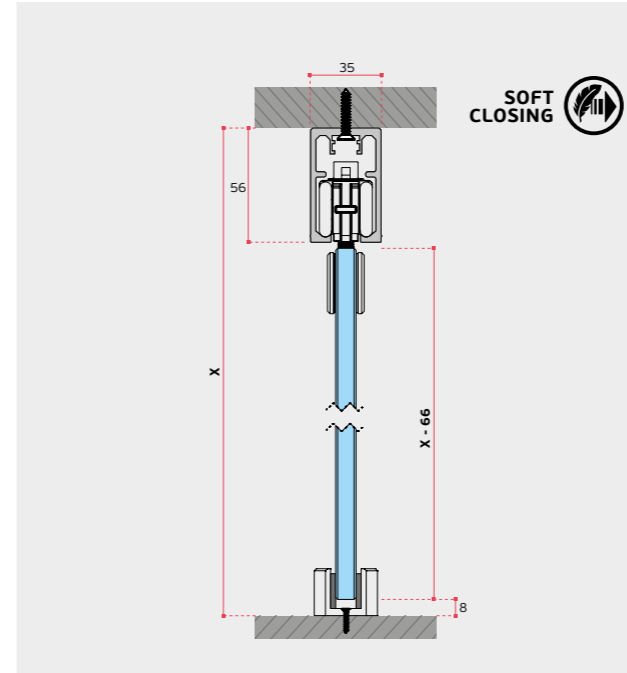
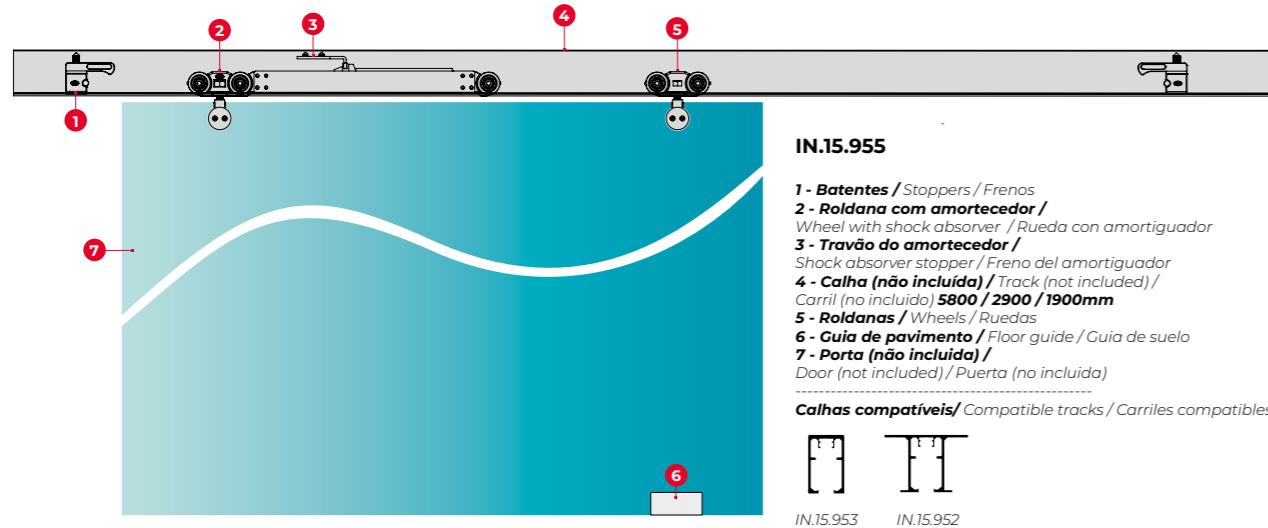

K60 with soft closing

Ceiling installation

IN.15.955 / Set
Sistema de porta de correr de vidro com fecho suave. / Glass sliding door system with soft close. / Sistema de puerta corredera de cristal con cierre suave.

- 1x - Roldana / Wheel / Rueda
- 1x - Roldana com amortecedor / Wheels with shock absorber / Ruedas con amortiguador.
- 2x - Batentes / Stoppers / Frenos
- 1x - Guia de pavimento / Floor guide / Guia de suelo

IN.15.953.1900 / Un.
IN.15.953.2900 / Un.
IN.15.953.5800 / Un.

Carril superior / Upper track / Carril superior
1900 / 2900 / 5800mm.

EN1527 5|2-1|3-1|2

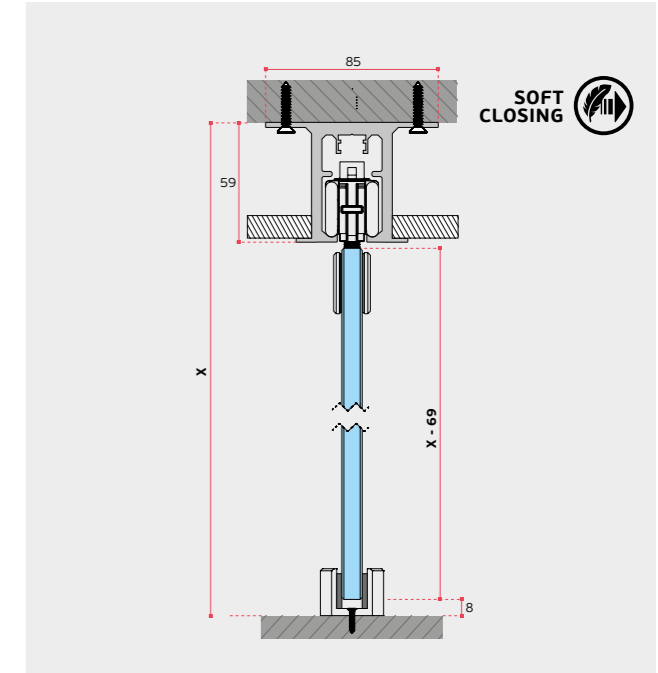
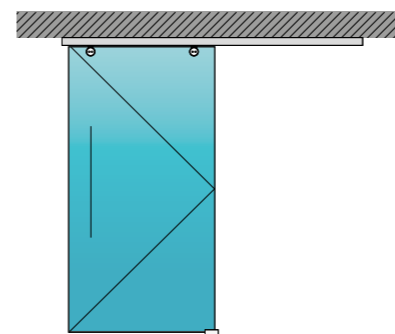

K60 soft for glass

False ceiling installation

IN.15.955 / Set
Sistema de porta de correr de vidro com fecho suave. / Glass sliding door system with soft close. / Sistema de puerta corredera de cristal con cierre suave.

- 1x - Roldana / Wheel / Rueda
- 1x - Roldana com amortecedor / Wheels with shock absorber / Ruedas con amortiguador.
- 2x - Batentes / Stoppers / Frenos
- 1x - Guia de pavimento / Floor guide / Guia de suelo

IN.15.952.1900 / Un.
IN.15.952.2900 / Un.
IN.15.952.5800 / Un.

Carril superior / Upper track / Carril superior
1900 / 2900 / 5800mm.

EN1527 5|2-1|3-1|2

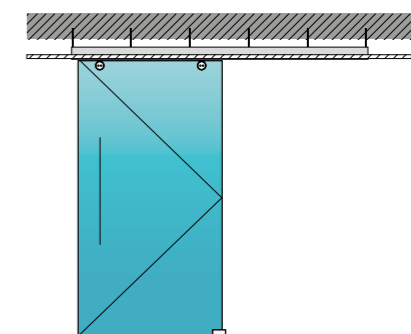

K60

Sliding door system for glass

Sistema de porta de correr de vidro /
Glass sliding door system /
Sistema de puerta corredera de cristal.

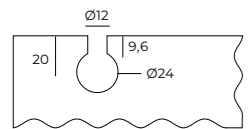
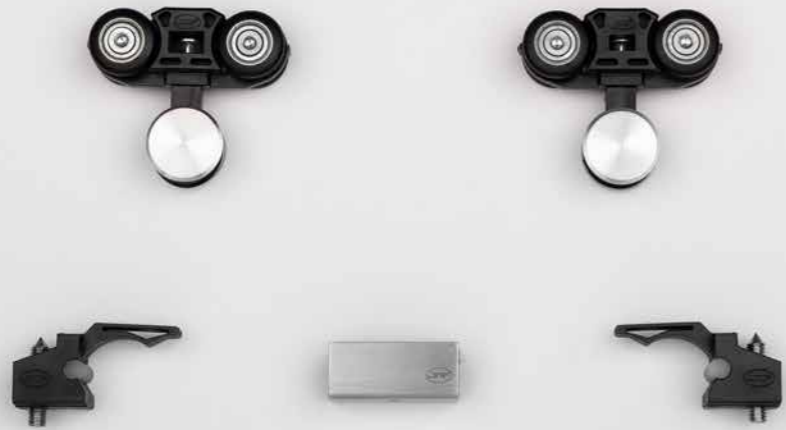
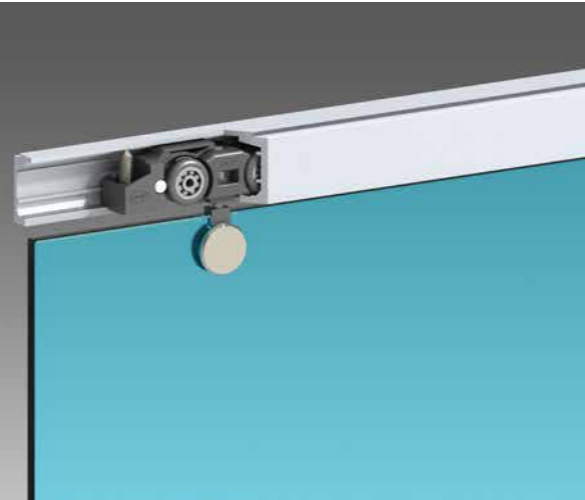

Medidas dos furos a efectuar no vidro /
Sizes of the holes to be made in the glass /
Medidas de los taladros en el cristal.

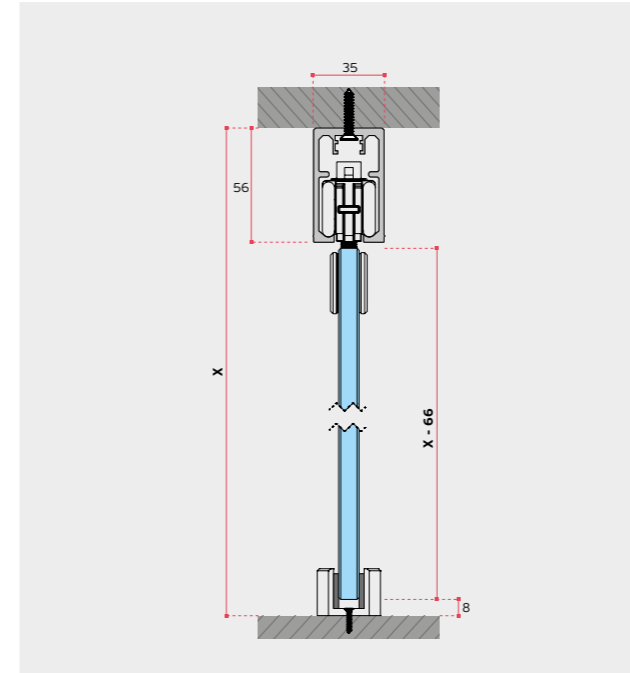
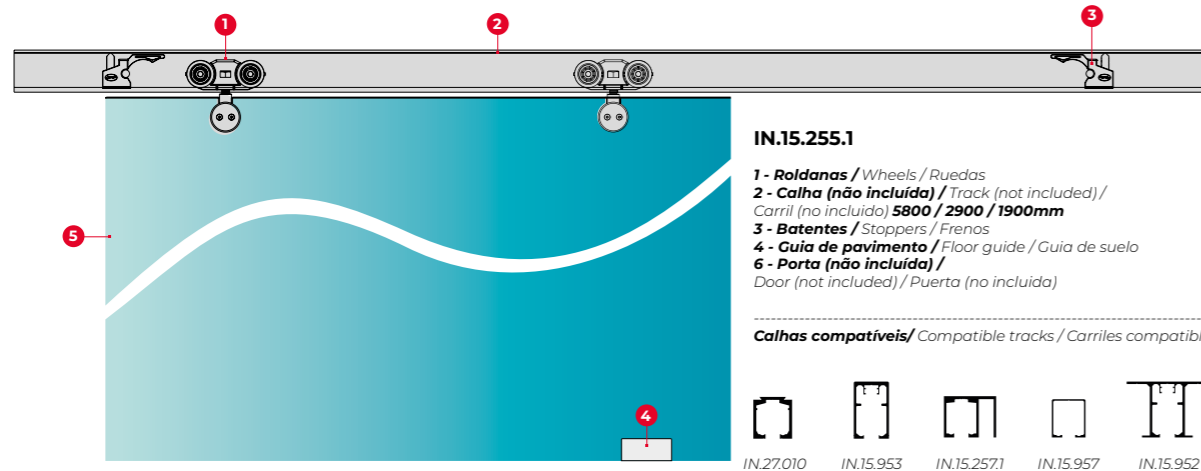
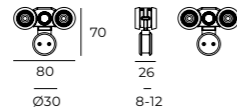

K60 Sliding door system

Ceiling installation

IN.15.255.1 / Set



Sistema de porta de correr de vidro /
Glass sliding door system /
Sistema de puerta corredera de cristal.

2x - Roldanas / Wheels / Ruedas.
2x - Batentes / Stoppers / Frenos.
1x - Guia de pavimento / Floor guide / Guia de suelo.

IN.15.953.1900 / Un.
IN.15.953.2900 / Un.
IN.15.953.5800 / Un.



Carril superior / Upper track / Carril superior.
1900 / 2900 / 5800mm.

EN1527 ■ 5 | 2 | - | 1 | 3 | - | 1 | 2

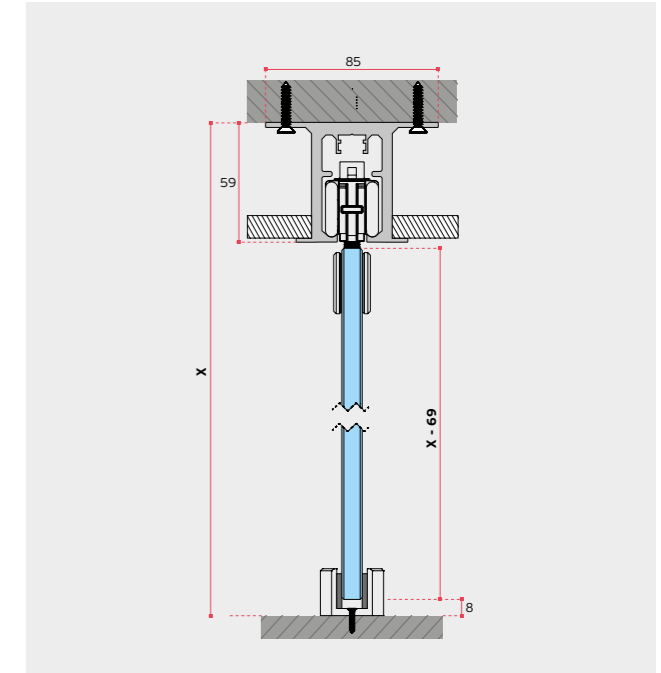
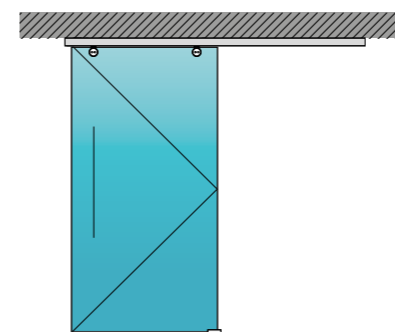

K60 Sliding door system

False ceiling installation

IN.15.255.1 / Set



Sistema de porta de correr de vidro /
Glass sliding door system /
Sistema de puerta corredera de cristal.

2x - Roldanas / Wheels / Ruedas.
2x - Batentes / Stoppers / Frenos.
1x - Guia de pavimento / Floor guide / Guia de suelo.

IN.15.952.1900 / Un.
IN.15.952.2900 / Un.
IN.15.952.5800 / Un.



Carril superior / Upper track / Carril superior.
1900 / 2900 / 5800mm.

EN1527 ■ 5 | 2 | - | 1 | 3 | - | 1 | 2

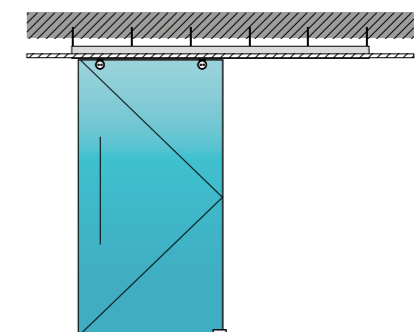

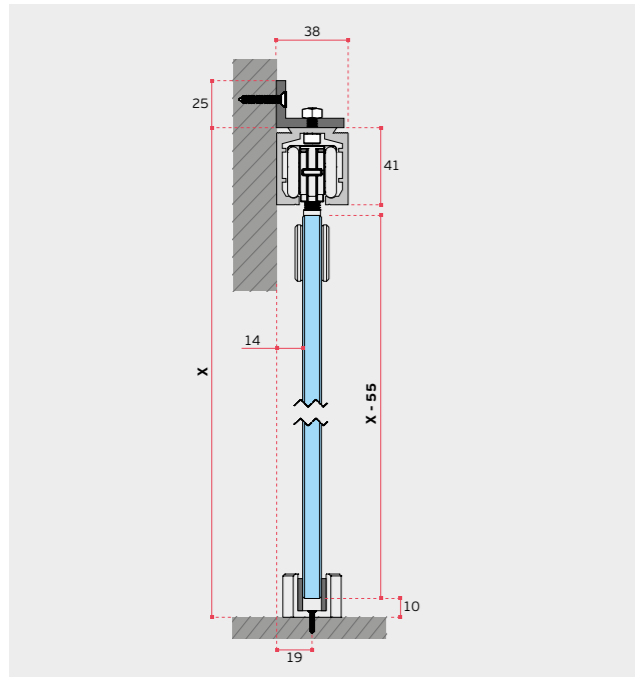

K60 Sliding door system Wall installation

IN.15.255.1 / Set



Sistema de porta de correr de vidro /
Glass sliding door system /
Sistema de puerta corredera de cristal.
2x - **Roldanas** / Wheels / Ruedas.
2x - **Batentes** / Stoppers / Frenos.
1x - **Guia de pavimento** / Floor guide / Guia de suelo.

IN.27.010.1900 / Un.
IN.27.010.2900 / Un.
IN.27.010.5800 / Un.
Carril superior / Upper track / Carril superior.
1900 / 2900 / 5800mm.



IN.15.255.2 / Set
Suportes de parede /
Wall supports / Soportes para pared.



IN.15.255.4 / Un.
Coberturas de topo / End covers / Tapas laterales.
EN1527 ■ 5|2|-1|3|-1|2

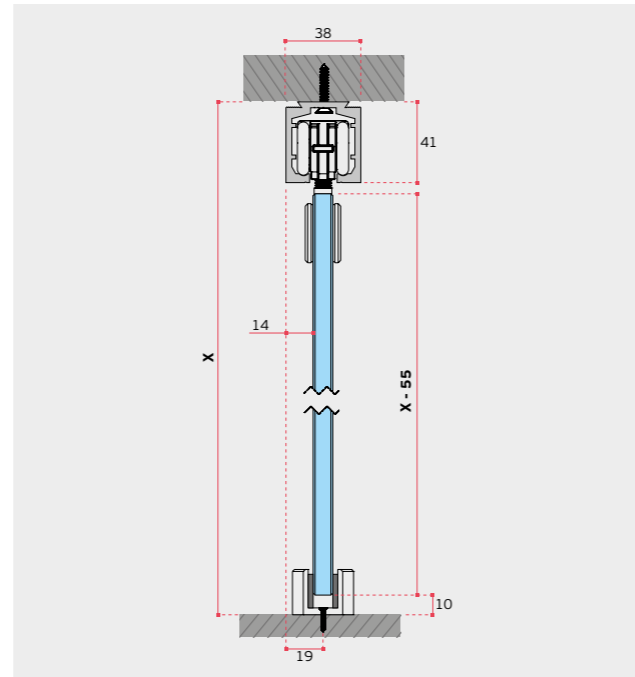
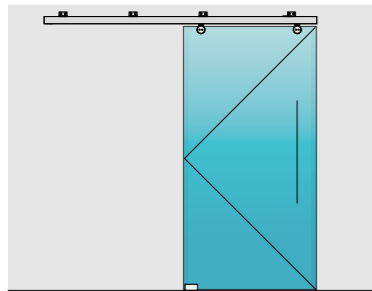

K60 Sliding door system Ceiling installation

IN.15.255.1 / Set



Sistema de porta de correr de vidro /
Glass sliding door system /
Sistema de puerta corredera de cristal.
2x - **Roldanas** / Wheels / Ruedas.
2x - **Batentes** / Stoppers / Frenos.
1x - **Guia de pavimento** / Floor guide / Guia de suelo.

IN.27.010.1900 / Un.
IN.27.010.2900 / Un.
IN.27.010.5800 / Un.
Carril superior / Upper track / Carril superior.
1900 / 2900 / 5800mm.



IN.15.255.4 / Un.
Coberturas de topo / End covers / Tapas laterales.

EN1527 ■ 5|2|-1|3|-1|2

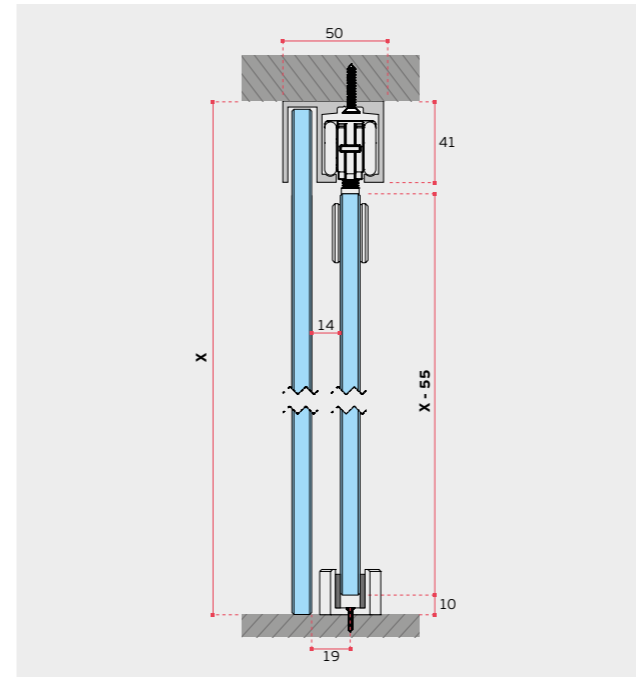
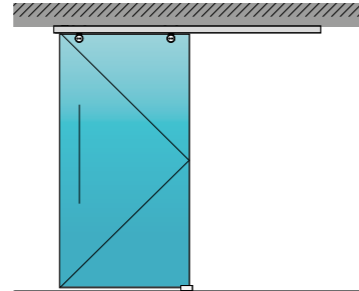

K60 Sliding door system Ceiling / Sideglass

IN.15.255.1 / Set



Sistema de porta de correr de vidro /
Glass sliding door system /
Sistema de puerta corredera de cristal.
2x - **Roldanas** / Wheels / Ruedas
2x - **Batentes** / Stoppers / Frenos
1x - **Guia de pavimento** / Floor guide / Guia de suelo

IN.15.257.1.1900 / Un.
IN.15.257.1.2900 / Un.
IN.15.257.1.5800 / Un.



Carril superior / Upper track / Carril superior
1900 / 2900 / 5800mm.

EN1527 ■ 5|2|-1|3|-1|2

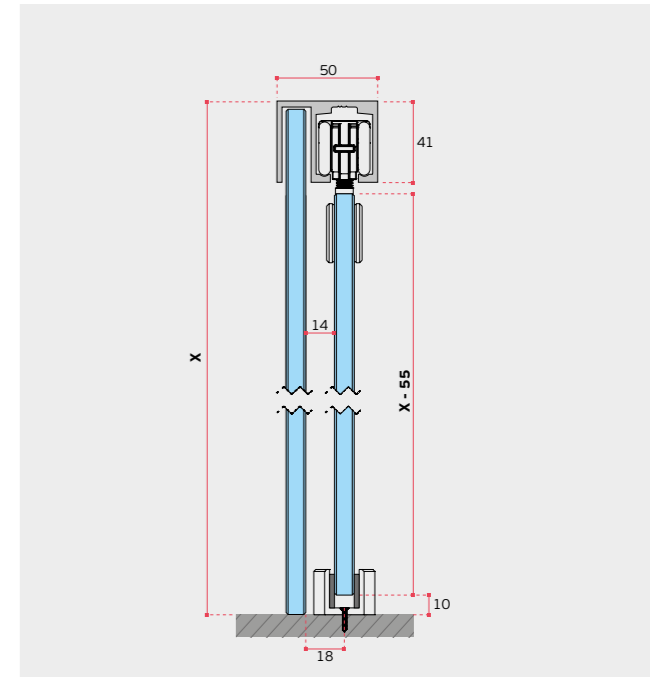
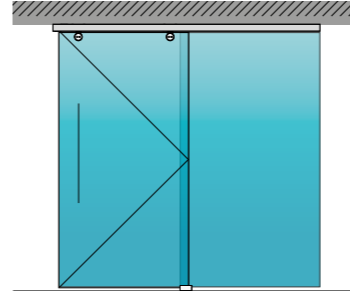

K60 Sliding door system Fixed sideglass

IN.15.255.1 / Set



Sistema de porta de correr de vidro /
Glass sliding door system /
Sistema de puerta corredera de cristal.
2x - **Roldanas** / Wheels / Ruedas
2x - **Batentes** / Stoppers / Frenos
1x - **Guia de pavimento** / Floor guide / Guia de suelo

IN.15.257.1.1900 / Un.
IN.15.257.1.2900 / Un.
IN.15.257.1.5800 / Un.
Carril superior / Upper track / Carril superior
1900 / 2900 / 5800mm.



IN.15.257.2 / Un.

Suporte de parede lateral /
Wall lateral support / Soporte de pared lateral.

EN1527 ■ 5|2|-1|3|-1|2

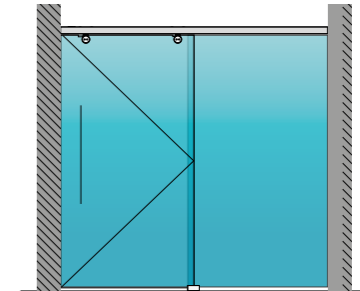

K110 Sliding door system for glass

Sistema de porta de correr de vidro com pinças.
sem mecanizações do vidro / Glass sliding door system
with clamps. No need cutout / Sistema de puerta corredera
de cristal con mordazas. Sin mecanizar lo cristal.

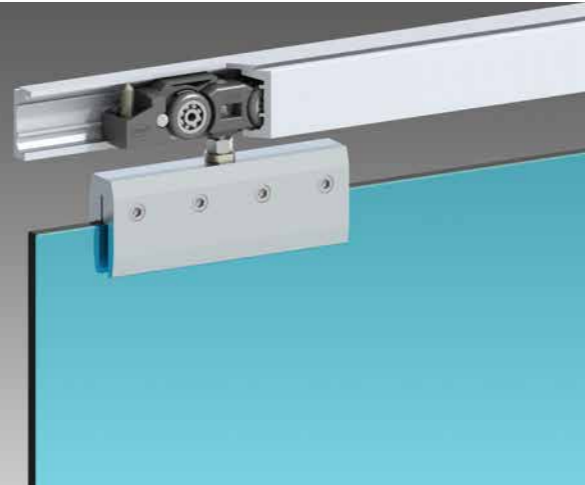

Peso máx de porta com pino / Max. load with pin / Peso max. con pino - 110 Kg
Peso máx de porta sem pino / Max. load without pin / Peso max. sin pino - 80 Kg

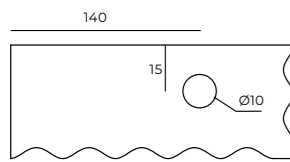

Medidas dos furos a efectuar no vidro
(se usar o pino de segurança) / Sizes of the
holes to be made in the glass (when using
the safety pin) / Medidas de los taladros en
el cristal (si utiliza el pin de seguridad).

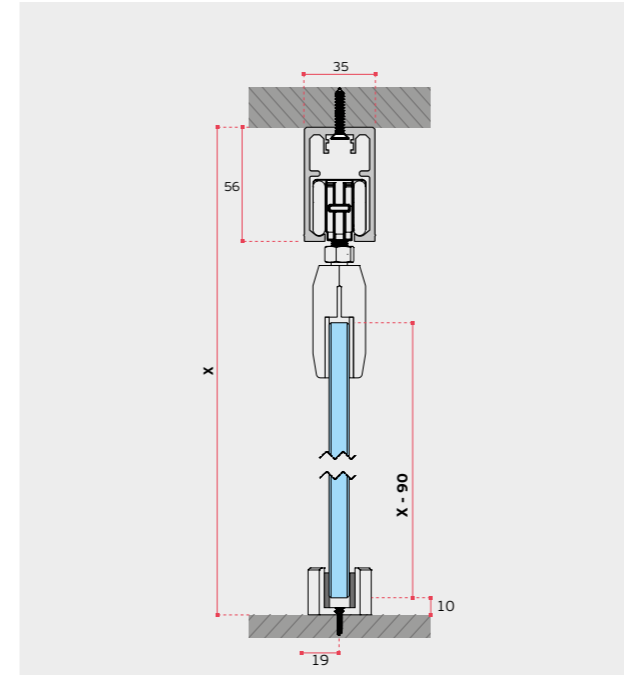
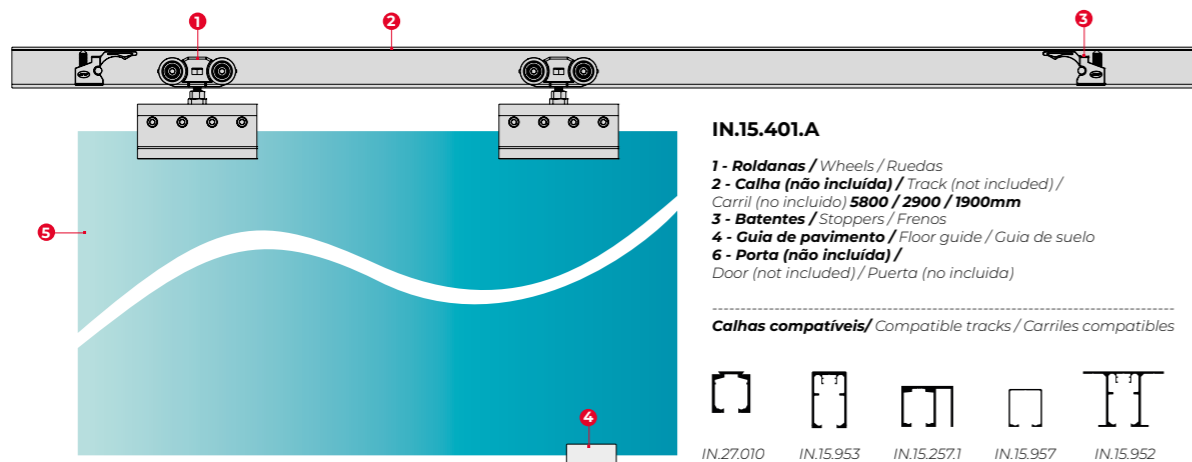
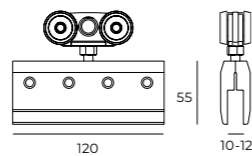

K110 Sliding door system Ceiling installation

IN.15.401.A / Set



Sistema de porta de correr de vidro com pinças.
sem mecanizações do vidro / Glass sliding door system
with clamps. No need cutout / Sistema de puerta corredera
de cristal con mordazas. Sin mecanizar el cristal.
2x - **Roldanas / Wheels / Ruedas.**
2x - **Batentes / Stoppers / Frenos.**
1x - **Guia de pavimento / Floor guide / Guia de suelo.**

IN.15.953.1900 / Un.
IN.15.953.2900 / Un.
IN.15.953.5800 / Un.



Carril superior / Upper track / Carril superior
1900 / 2900 / 5800mm.

EN1527 ■ 5 | 2 | - | 1 | 3 | - | 1 | 2

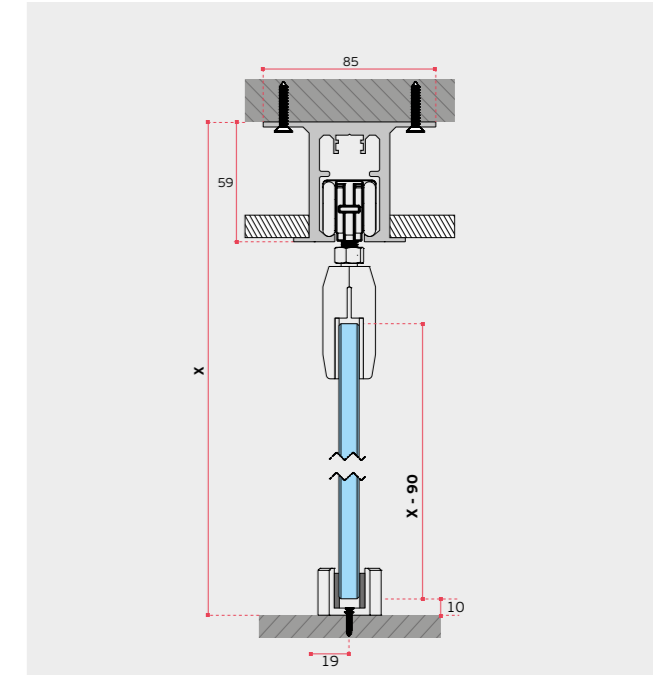
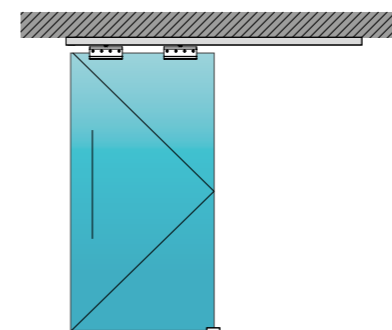

K110 Sliding door system False ceiling installation

IN.15.401.A / Set



Sistema de porta de correr de vidro com pinças.
sem mecanizações do vidro / Glass sliding door system
with clamps. No need cutout / Sistema de puerta corredera
de cristal con mordazas. Sin mecanizar el cristal.
2x - **Roldanas / Wheels / Ruedas.**
2x - **Batentes / Stoppers / Frenos.**
1x - **Guia de pavimento / Floor guide / Guia de suelo.**

IN.15.952.1900 / Un.
IN.15.952.2900 / Un.
IN.15.952.5800 / Un.



Carril superior / Upper track / Carril superior
1900 / 2900 / 5800mm.

EN1527 ■ 5 | 2 | - | 1 | 3 | - | 1 | 2

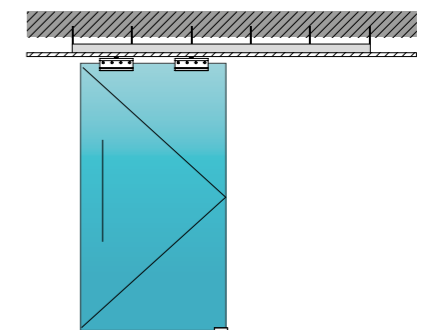

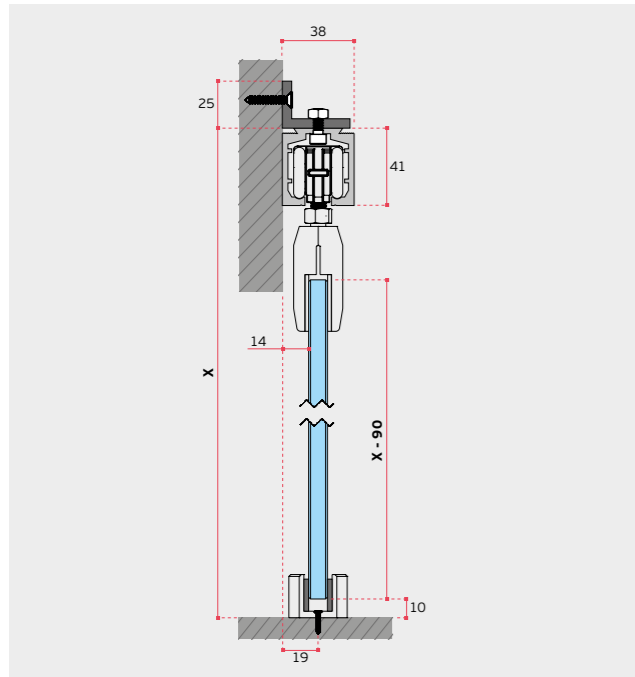

K110 Sliding door system Wall installation

IN.15.401.A / Set
Sistema de porta de correr de vidro com pinças.
sem mecanizações do vidro / Glass sliding door
system with clamps. No need cutout / Sistema de
puerta corredera de cristal con mordazas. Sin mecanizar lo cristal.
2x - **Roldanas / Wheels / Ruedas.**
2x - **Batentes / Stoppers / Frenos.**
1x - **Guia de pavimento / Floor guide / Guia de suelo.**



IN.27.010.1900 / Un.
IN.27.010.2900 / Un.
IN.27.010.5800 / Un.
Carril superior / Upper track / Carril superior
1900 / 2900 / 5800mm.



IN.15.255.2 / Set
Suportes de parede /
Wall supports / Soportes para pared.



IN.15.255.4 / Un.
Coberturas de topo /
End covers / Tapas laterales.



EN1527 ■ 5|2|-1|3|-1|2

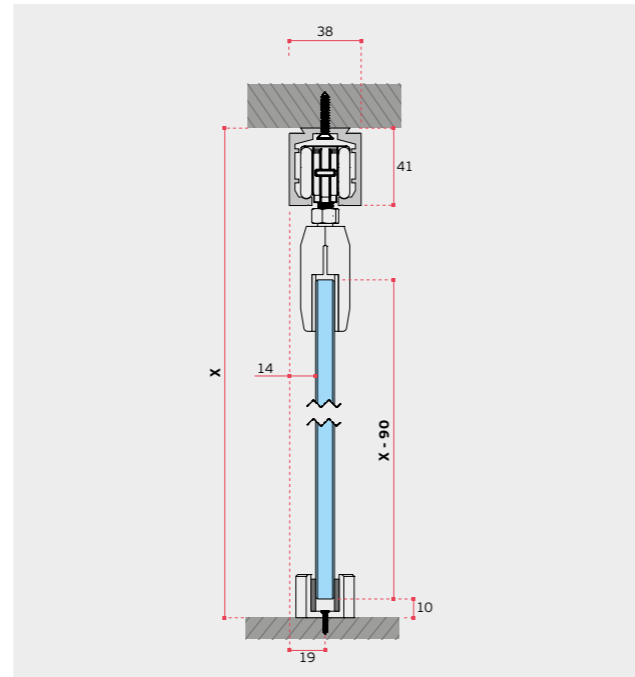
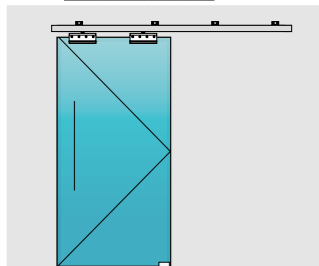

K110 Sliding door system Ceiling installation

IN.15.401.A / Set
Sistema de porta de correr de vidro
com pinças. sem mecanizações do vidro /
Glass sliding door system with clamps. No need cutout /
Sistema de puerta corredera de cristal con mordazas.
Sin mecanizar lo cristal.
2x - **Roldanas / Wheels / Ruedas.**
2x - **Batentes / Stoppers / Frenos.**
1x - **Guia de pavimento / Floor guide / Guia de suelo.**



IN.27.010.1900 / Un.
IN.27.010.2900 / Un.
IN.27.010.5800 / Un.
Carril superior / Upper track / Carril superior
1900 / 2900 / 5800mm.



IN.15.255.4 / Un.
Coberturas de topo / End covers / Tapas laterales.

EN1527 ■ 5|2|-1|3|-1|2

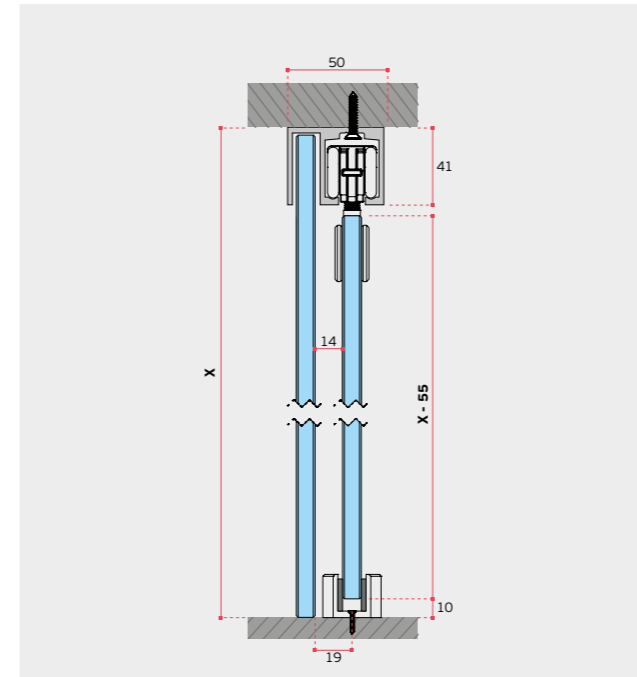
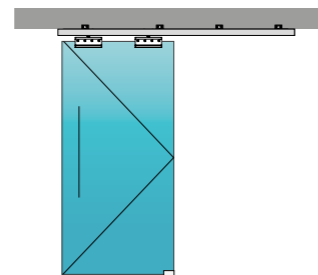

K110 Sliding door system Ceiling / Sideglass

IN.15.401.A / Set
Sistema de porta de correr de vidro
com pinças. Sem mecanizações do vidro /
Glass sliding door system with clamps. No need cutout /
Sistema de puerta corredera de cristal con mordazas.
Sin mecanizar lo cristal.
2x - **Roldanas / Wheels / Ruedas.**
2x - **Batentes / Stoppers / Frenos.**
1x - **Guia de pavimento / Floor guide / Guia de suelo.**



IN.15.257.1.1900 / Un.
IN.15.257.1.2900 / Un.
IN.15.257.1.5800 / Un.
Carril superior / Upper track / Carril superior.
1900 / 2900 / 5800mm.



EN1527 ■ 5|2|-1|3|-1|2

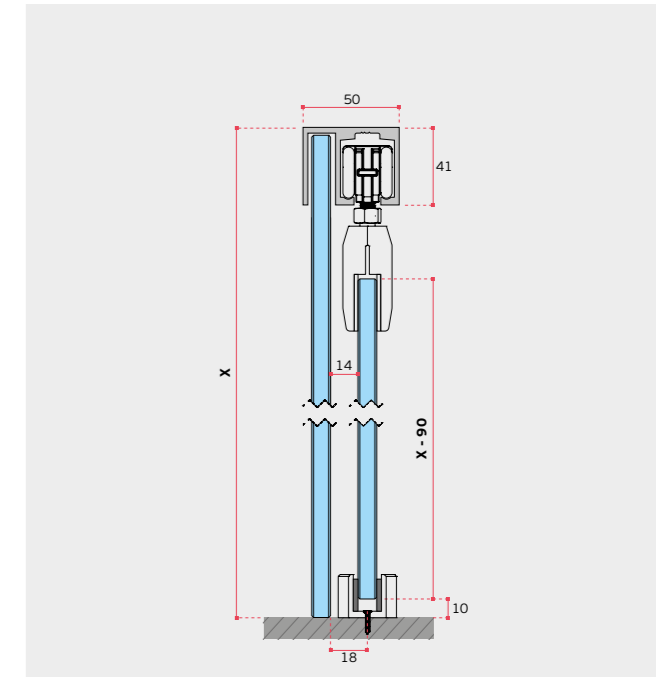
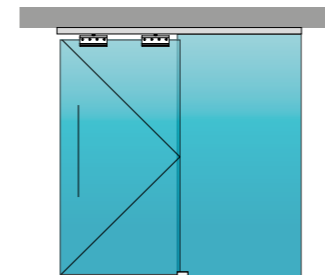

K110 Sliding door system Fixed sideglass

IN.15.401.A / Set
Sistema de porta de correr de vidro
com pinças. Sem mecanizações do vidro /
Glass sliding door system with clamps. No need cutout /
Sistema de puerta corredera de cristal con mordazas.
Sin mecanizar lo cristal.
2x - **Roldanas / Wheels / Ruedas.**
2x - **Batentes / Stoppers / Frenos.**
1x - **Guia de pavimento / Floor guide / Guia de suelo.**



IN.15.257.1.1900 / Un.
IN.15.257.1.2900 / Un.
IN.15.257.1.5800 / Un.
Carril superior / Upper track / Carril superior.
1900 / 2900 / 5800mm.



IN.15.257.2 / Un.
Suporte de parede lateral /
Wall lateral support / Soporte de pared lateral.

EN1527 ■ 5|2|-1|3|-1|2

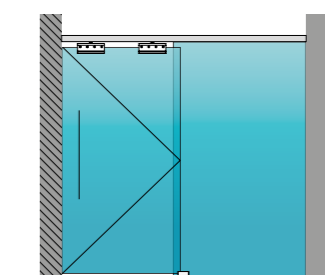



Upper prof. support track for suspended ceiling

IN.15.954.1900 / Un.
IN.15.954.2900 / Un.
IN.15.954.5800 / Un.



Carril superior de fixação ao tecto falso. Tem de ser aplicado em conjunto com IN.15.953 / Upper track for suspended ceiling support. Must be installed along with IN.15.953 / Carril superior con fijación al tecto falso. Debe ser instalado en conjunto con IN.15.953.

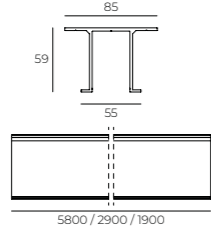

Upper track for ceiling support profile

IN.15.953.1900 / Un.
IN.15.953.2900 / Un.
IN.15.953.5800 / Un.



Carril superior de fixação ao tecto, instalar com calha complementar IN.15.954 / Upper track for ceiling support, install with complementary track profile IN.15.954 / Carril superior con fijación al tecto, instalar con carril complementar IN.15.954.

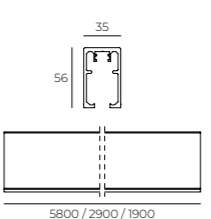

Upper track for suspended ceiling

IN.15.952.1900 / Un.
IN.15.952.2900 / Un.
IN.15.952.5800 / Un.



Carril superior de fixação ao tecto falso / Upper track for suspended ceiling support / Carril superior con fijación al tecto falso.

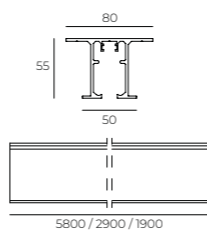

Upper track fixed glass support

IN.15.257.1.1900 / Un.
IN.15.257.1.2900 / Un.
IN.15.257.1.5800 / Un.



Carril superior com suporte para vidro fixo / Upper track with fixed glass support / Carril superior con soporte al cristal fijo.

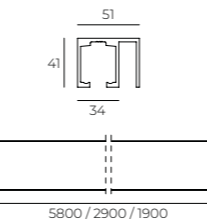

Upper track for wall / ceiling support

IN.15.957.1900 / Un.
IN.15.957.2900 / Un.
IN.15.957.5800 / Un.



Carril superior / Upper track / Carril superior.

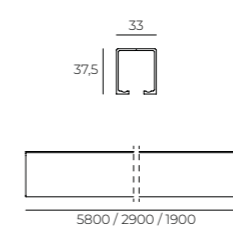

Upper track for wall / ceiling support

IN.27.010.1900 / Un.
IN.27.010.2900 / Un.
IN.27.010.5800 / Un.



Carril superior / Upper track / Carril superior.

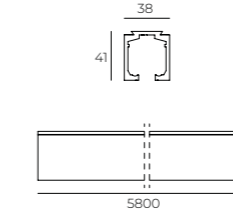

Cover

IN.15.255.4 / Un.

Tampa de topo / End cover / Tampa.

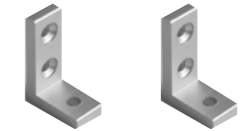

End supports

IN.15.257.2 / Un.

Suporte de parede lateral / Wall lateral support / Soporte de pared lateral.



Wall supports

IN.15.255.2 / Set

Suporte de parede / Wall support / Soporte de pared.



Track support

IN.15.256.1 / Un.

Suporte da calha ao vidro fixo / Fixed glass track support / Soporte de guía al cristal fijo



FREELINE

BY JNF



YOUR FREEDOM
HARDWARE.

Charriot para portas de correr de vidro / 6.17
Charriot for glass sliding doors /
Charriot para puertas correderas de cristal.

CHARRIOT INOX COLOR

Sliding door system for glass

Sistema para porta de correr em vidro de fixação à parede. Guia e carros em alumínio anodizado. Rodas em nylon com fibra de vidro e rolamento de esferas. Sistema desenvolvido para instalação fácil /

Wall-mounted sliding glass door system. Guide and carriages in anodized aluminum. Nylon wheels with fiberglass and ball bearing. System developed for easy installation /

Sistema de puertas correderas de cristal de fijación en la pared. Guía y carros en aluminio anodizado. Ruedas de nylon con fibra de cristal y rodamiento de bolas. Sistema desarrollado para una fácil instalación.

FREELINE

BY JNF



SOLUÇÕES PARA VIDRO /
SOLUTIONS FOR GLASS /
SOLUCIONES PARA CRISTAL.

Charriot para portas de correr de vidro / 6.17
Charriot for glass sliding doors /
Charriot para puertas correderas de cristal.



FOR GLASS DOORS

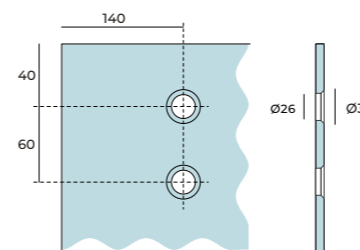
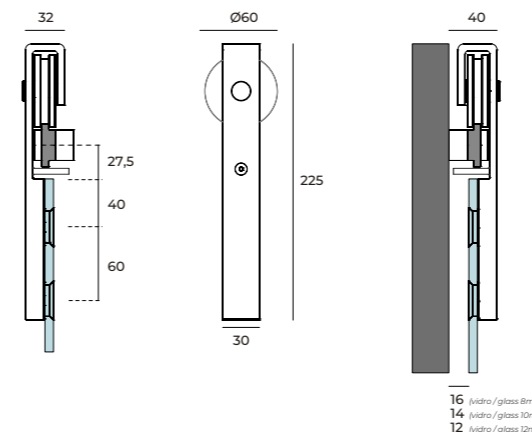
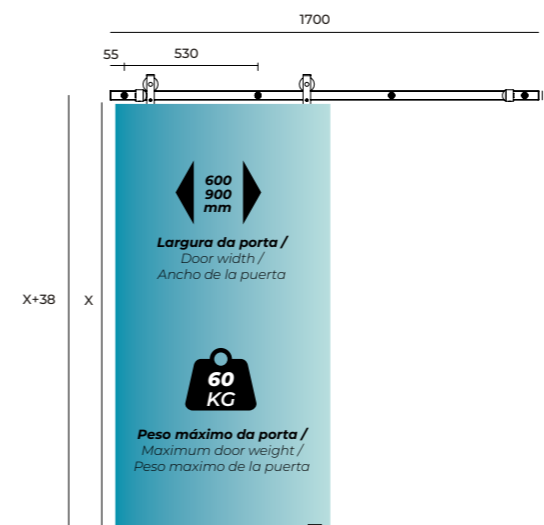

IN.15.900.S / Un.

Sistema manual com fecho suave para sistema charriot /
Manual system with soft closing for charriot system /
Sistema manual con cierre suave para sistema charriot.

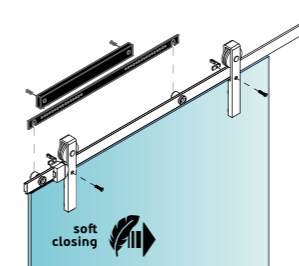

Charriot Inox color

For glass / Wall fixing

IN.15.900.I / Set

Sistema para porta de correr em vidro de fixação à parede. Guia e carros em alumínio anodizado. Rodas em nylon com fibra de vidro e rolamento de esferas. Sistema desenvolvido para instalação fácil /

Wall-mounted sliding glass door system. Guide and carriages in anodized aluminum. Nylon wheels with fiberglass and ball bearing. System developed for easy installation /

Sistema de puertas correderas de cristal de fijación en la pared. Guía y carros en aluminio anodizado. Ruedas de nylon con fibra de cristal y rodamiento de bolas. Sistema desarrollado para una fácil instalación.

2x - Roldanas / Wheels / Ruedas
2x - Batentes / Stoppers / Frenos
1x - Guia de pavimento /
Floor guide / Guia de suelo
1x - Carril de alumínio 1700mm /
Aluminium track 1700mm / Guia de alumínio 1700mm.

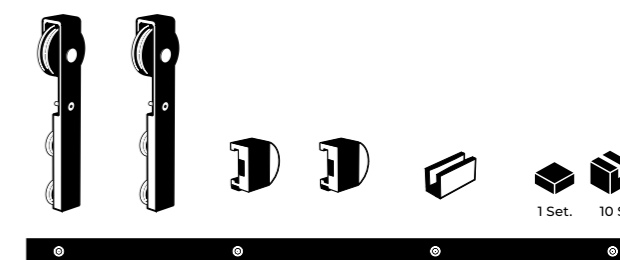

FREELINE



YOUR FREEDOM
HARDWARE.

Charriot para portas de correr de vidro / 6.17
Charriot for glass sliding doors / Charriot
para puertas correderas de cristal.

CHARRIOT BLACK COLOR

Sliding door system for glass

Sistema para porta de correr em vidro de fixação à parede. Guia e carros em alumínio anodizado. Rodas em nylon com fibra de vidro e rolamento de esferas. Sistema desenvolvido para instalação fácil /

Wall-mounted sliding glass door system. Guide and carriages in anodized aluminum. Nylon wheels with fiberglass and ball bearing. System developed for easy installation /

Sistema de puertas correderas de cristal de fijación en la pared. Guía y carros en aluminio anodizado. Ruedas de nylon con fibra de cristal y rodamiento de bolas. Sistema desarrollado para una fácil instalación.

FREELINE



SOLUÇÕES PARA VIDRO /
SOLUTIONS FOR GLASS /
SOLUCIONES PARA CRISTAL.

Charriot para portas de correr de vidro / 6.17
Charriot for glass sliding doors / Charriot
para puertas correderas de cristal.



FOR GLASS DOORS

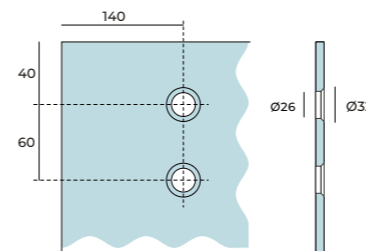
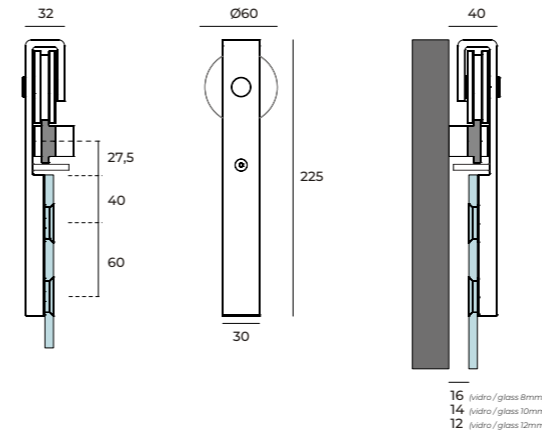
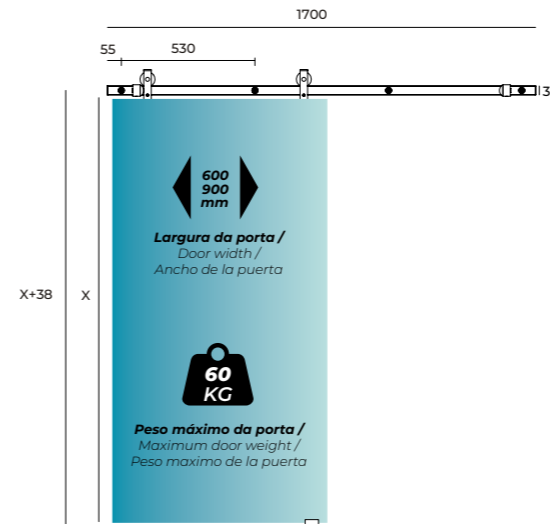

IN.15.900.S / Un.

Sistema manual com fecho suave para sistema charriot /
Manual system with soft closing for charriot system /
Sistema manual con cierre suave para sistema charriot.

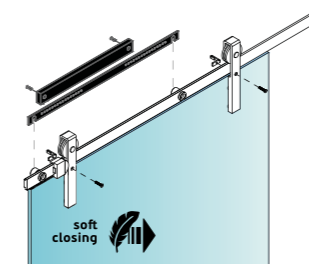

Charriot Black color

For glass / Wall fixing

IN.15.900.N / Set

Sistema para porta de correr em vidro de fixação à parede. Guia e carros em alumínio anodizado. Rodas em nylon com fibra de vidro e rolamento de esferas. Sistema desenvolvido para instalação fácil /

Wall-mounted sliding glass door system. Guide and carriages in anodized aluminum. Nylon wheels with fiberglass and ball bearing. System developed for easy installation /

Sistema de puertas correderas de cristal de fijación en la pared. Guía y carros en aluminio anodizado. Ruedas de nylon con fibra de cristal y rodamiento de bolas. Sistema desarrollado para una fácil instalación.

2x - Roldanas / Wheels / Ruedas
2x - Batentes / Stoppers / Frenos
1x - Guia de pavimento /
Floor guide / Guia de suelo
1x - Carril de alumínio 1700mm /
Aluminium track 1700mm / Guia de alumínio 1700mm.

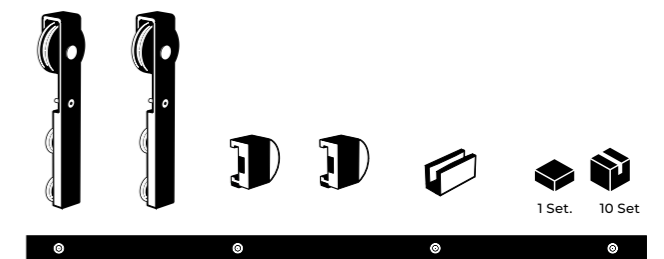

CHARRIOT BRONZE COLOR

Sliding door system for glass

Sistema para porta de correr em vidro de fixação à parede. Guia e carros em alumínio anodizado. Rodas em nylon com fibra de vidro e rolamento de esferas. Sistema desenvolvido para instalação fácil /

Wall-mounted sliding glass door system. Guide and carriages in anodized aluminum. Nylon wheels with fiberglass and ball bearing. System developed for easy installation /

Sistema de puertas correderas de cristal de fijación en la pared. Guía y carros en aluminio anodizado. Ruedas de nylon con fibra de cristal y rodamiento de bolas. Sistema desarrollado para una fácil instalación.



FOR GLASS DOORS

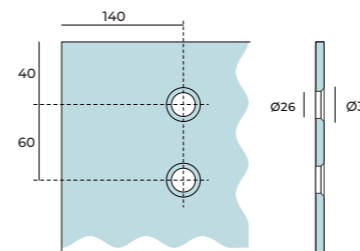
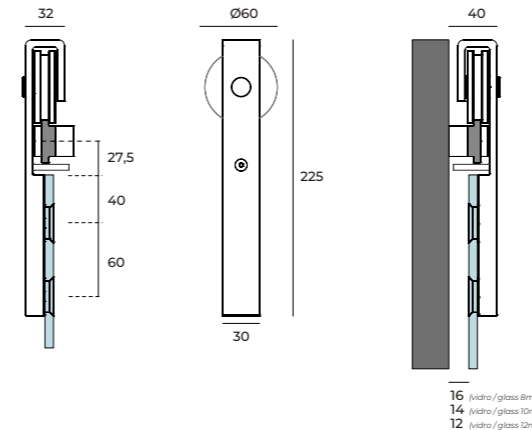
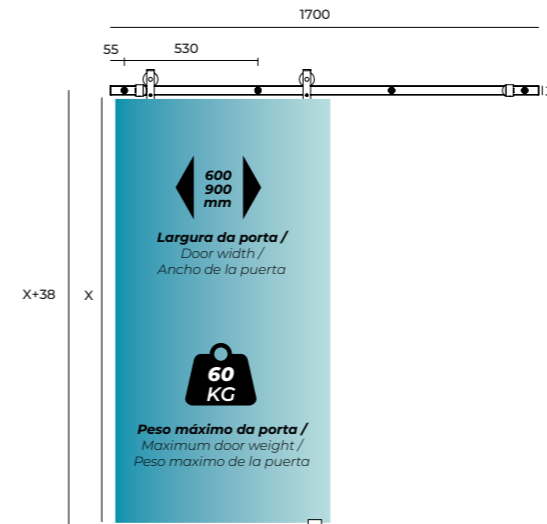

IN.15.900.S / Un.

Sistema manual com fecho suave para sistema charriot /
Manual system with soft closing for charriot system /
Sistema manual con cierre suave para sistema charriot.

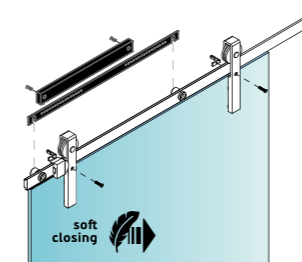

Charriot Bronze color

For glass / Wall fixing

IN.15.900.B / Set

Sistema para porta de correr em vidro de fixação à parede. Guia e carros em alumínio anodizado. Rodas em nylon com fibra de vidro e rolamento de esferas. Sistema desenvolvido para instalação fácil /

Wall-mounted sliding glass door system. Guide and carriages in anodized aluminum. Nylon wheels with fiberglass and ball bearing. System developed for easy installation /

Sistema de puertas correderas de cristal de fijación en la pared. Guía y carros en aluminio anodizado. Ruedas de nylon con fibra de cristal y rodamiento de bolas. Sistema desarrollado para una fácil instalación.

- 2x - Roldanas / Wheels / Ruedas
- 2x - Batentes / Stoppers / Frenos
- 1x - Guia de pavimento / Floor guide / Guia de suelo
- 1x - Carril de alumínio 1700mm / Aluminium track 1700mm / Guia de alumínio 1700mm.

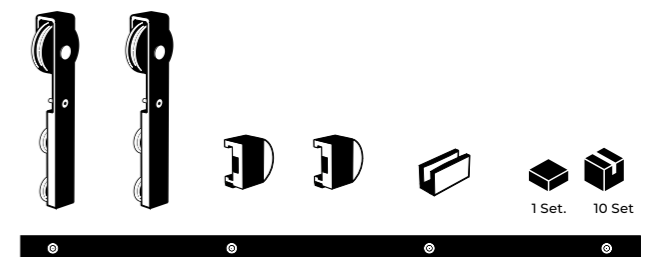

7

SISTEMAS PARA PORTAS DE CORRER / **SLIDING DOORS SYSTEMS /** SISTEMAS PARA PUERTAS CORREDERAS.

7.1
**CHARRIOT PARA PORTAS
DE CORRER DE MADEIRA OU
METÁLICAS /**
CHARRIOT FOR WOODEN OR
METALLIC SLIDING DOORS
/ CHARRIOT PARA PUERTAS
CORREDERAS DE MADERA.

7.2
**OFFSCREEN LIGHT PARA PORTAS
DE MADEIRA / OFFSCREEN LIGHT
FOR WOODEN SLIDING DOORS /**
OFFSCREEN LIGHT PARA PUERTAS
DE MADERA.

7.3
**K80 PARA PORTAS DE CORRER DE
MADEIRA / K80 FOR
WOODEN SLIDING DOORS /**
K80 PARA PUERTAS CORREDERAS
DE MADERA.

7.4
**IN.15.40K PARA PORTAS DE
CORRER DE MADEIRA /**
IN.15.40K FOR WOODEN SLIDING
DOORS /
IN.15.40K PARA PUERTAS
CORREDERAS DE MADERA.

7.5
**IN.15.40S PARA PORTAS DE
CORRER DE MADEIRA /**
IN.15.40S FOR WOODEN SLIDING
DOORS / IN.15.40S PARA PUERTAS
CORREDERAS DE MADERA.

7.6
**IN.15.100S PARA PORTAS DE
CORRER DE MADEIRA /**
IN.15.100.S FOR WOODEN
SLIDING DOORS /
IN.15.100.S PARA PUERTAS
CORREDERAS DE MADERA.



CHARRIOT

Sliding door system for metallic and wood doors

Sistema para porta de correr em madeira ou metálica de fixação à parede. Guia e carros em alumínio anodizado. Rodas em nylon com fibra de vidro e rolamento de esferas. Sistema desenvolvido para instalação fácil /

Wall-mounted sliding wooden or metallic door system. Guide and carriages in anodized aluminum. Nylon wheels with fiberglass and ball bearing. System developed for easy installation /

Sistema de puertas correderas en madera o metálica de fijación en la pared. Guía y carros en aluminio anodizado. Ruedas de nylon con fibra de cristal y rodamiento de bolas. Sistema desarrollado para una fácil instalación.



CHARRIOT INOX COLOR

Sliding door system for metallic and wood doors

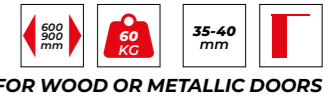

FOR WOOD OR METALLIC DOORS

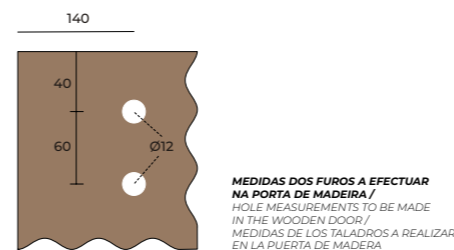
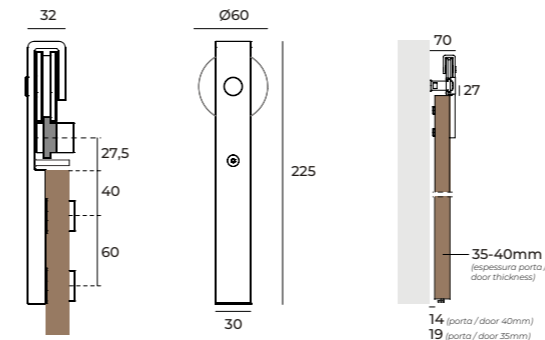
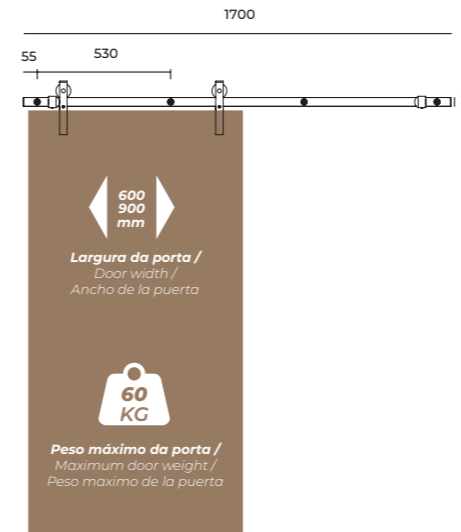

Charriot Inox color

For Wood / Wall fixing

IN.15.903.1 / Set

Sistema para porta de correr em madeira ou metálica de fixação à parede. Guia e carros em alumínio anodizado. Rodas em nylon com fibra de vidro e rolamento de esferas. Sistema desenvolvido para instalação fácil /

Wall-mounted sliding wooden or metallic door system. Guide and carriages in anodized aluminum. Nylon wheels with fiberglass and ball bearing. System developed for easy installation /

Sistema de puertas correderas en madera o metálica de fijación en la pared. Guía y carros en aluminio anodizado. Ruedas de nylon con fibra de cristal y rodamiento de bolas. Sistema desarrollado para una fácil instalación.

- 2x - Roldanas / Wheels / Ruedas
- 2x - Batentes / Stoppers / Frenos
- 1x - Guia de pavimento / Floor guide / Guia de suelo
- 1x - Carril de alumínio / Aluminium track / Guia de aluminio 1700mm

IN.15.900.S / Un.

Sistema manual com fecho suave para sistema charriot / Manual system with soft closing for charriot system / Sistema manual con cierre suave para sistema charriot.

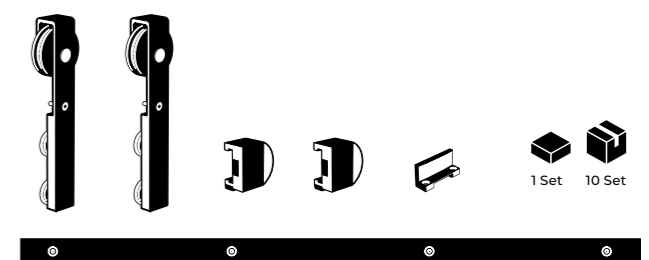
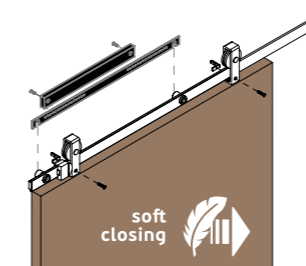

CHARRIOT BLACK COLOR

Sliding door system for metallic and wood doors



FOR WOOD OR METALLIC DOORS

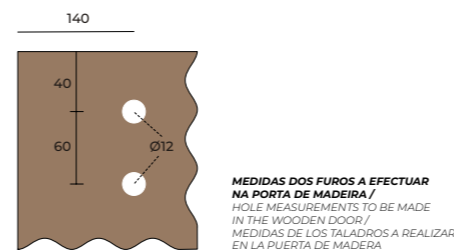
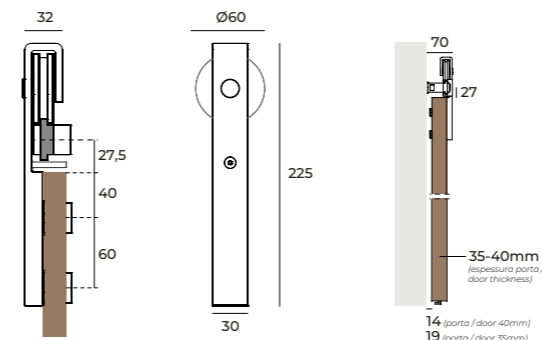
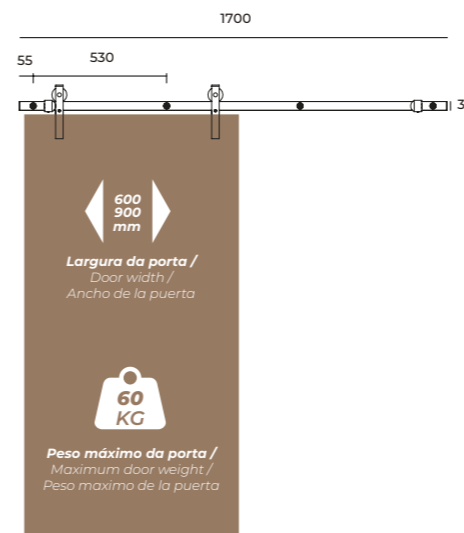

IN.15.900.S / Un.

Sistema manual com fecho suave para sistema charriot / Manual system with soft closing for charriot system / Sistema manual con cierre suave para sistema charriot.

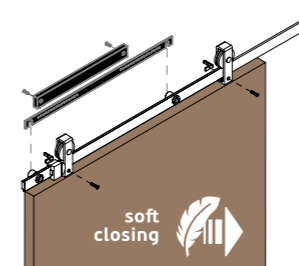

Charriot Black color

For Wood / Wall fixing

IN.15.903.N / Set

Sistema para porta de correr em madeira de fixação à parede. Guia e carros em alumínio termolacado. Rodas em nylon com fibra de vidro e rolamento de esferas. Sistema desenvolvido para instalação fácil /

Wall-mounted sliding wooden door system. Guide and carriages in powder coated aluminum. Nylon wheels with fiberglass and ball bearing. System developed for easy installation /

Sistema de puertas correderas de madera de fijación en la pared. Guía y carros en aluminio termo lacado. Ruedas de nylon con fibra de cristal y rodamiento de bolas. Sistema desarrollado para una fácil instalación.

- 2x - Roldanas / Wheels / Ruedas
- 2x - Batentes / Stoppers / Frenos
- 1x - Guia de pavimento / Floor guide / Guia de suelo
- 1x - Carril de alumínio / Aluminium track / Guia de aluminio 1700mm

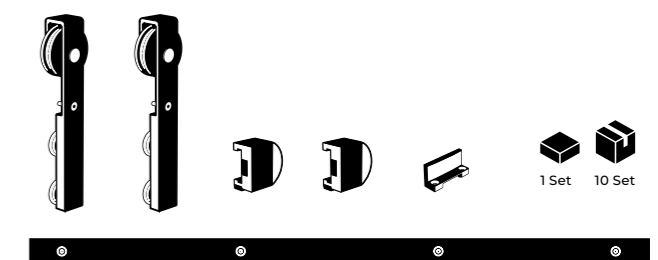

CHARRIOT BRONZE COLOR

Sliding door system
for metallic and
wood doors

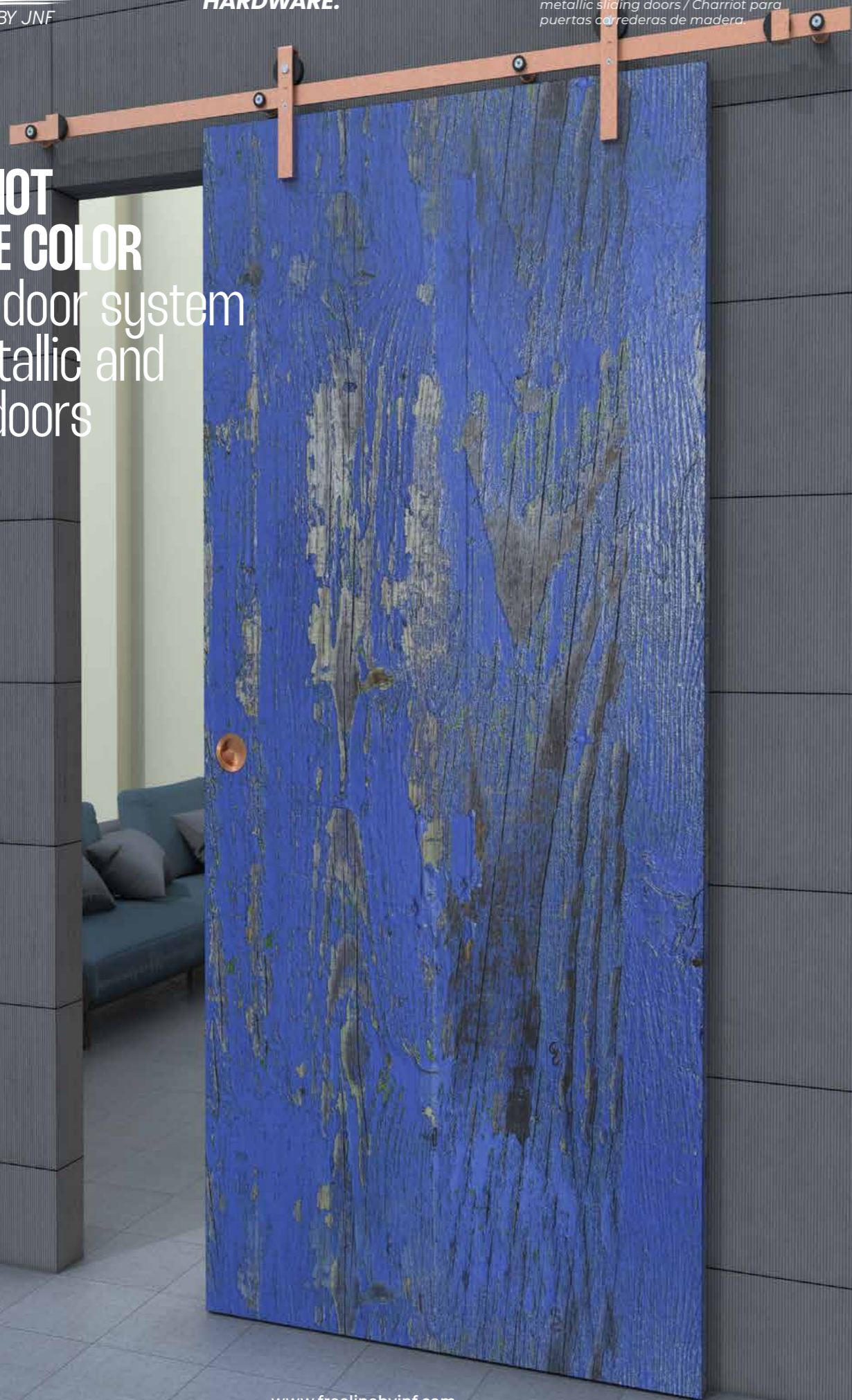

FOR WOOD OR METALLIC DOORS

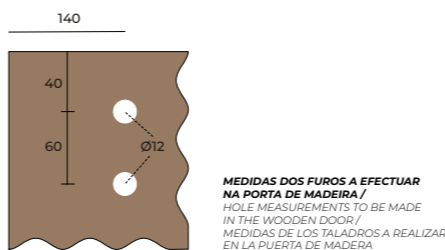
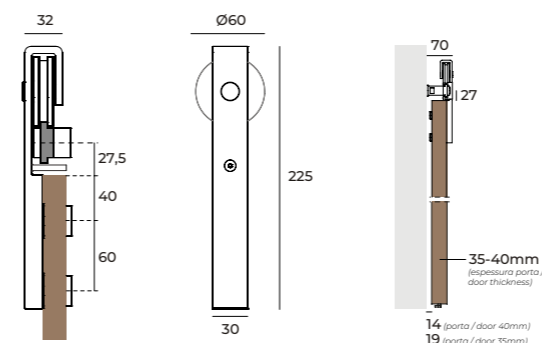
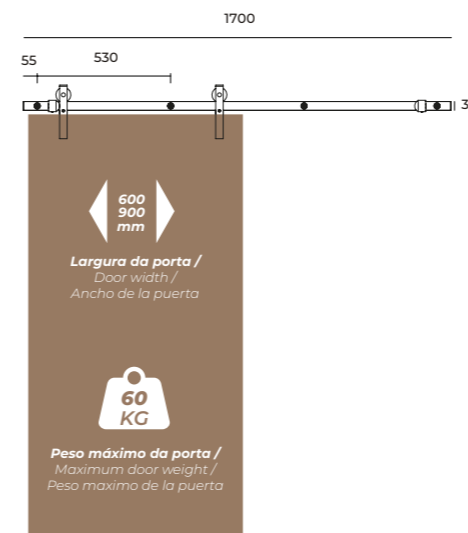

IN.15.900.S / Un.

Sistema manual com fecho suave para sistema charriot / Manual system with soft closing for charriot system / Sistema manual con cierre suave para sistema charriot.

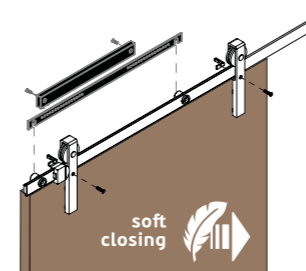

Charriot Bronze color For Wood / Wall fixing

IN.15.903.B / Set

Sistema para porta de correr em madeira ou metálica de fixação à parede. Guia e carros em alumínio anodizado. Rodas em nylon com fibra de vidro e rolamento de esferas. Sistema desenvolvido para instalação fácil /

Wall-mounted sliding wooden or metallic door system. Guide and carriages in anodized aluminum. Nylon wheels with fiberglass and ball bearing. System developed for easy installation /

Sistema de puertas correderas en madera o metálica de fijación en la pared. Guía y carros en aluminio anodizado. Ruedas de nylon con fibra de cristal y rodamiento de bolas. Sistema desarrollado para una fácil instalación.

- 2x - Roldanas / Wheels / Ruedas
- 2x - Batentes / Stoppers / Frenos
- 1x - Guia de pavimento / Floor guide / Guia de suelo
- 1x - Carril de alumínio / Aluminium track / Guia de aluminio 1700mm

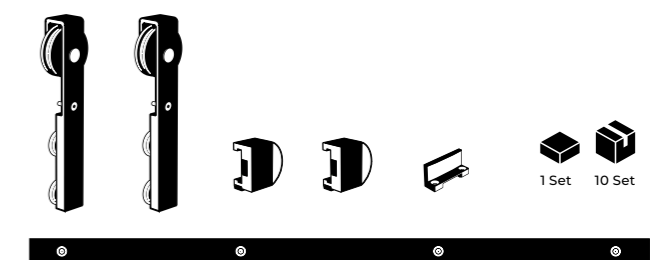

CHARRIOT INOX COLOR

Sliding door system for metallic and wood doors



FOR WOOD OR METALLIC DOORS

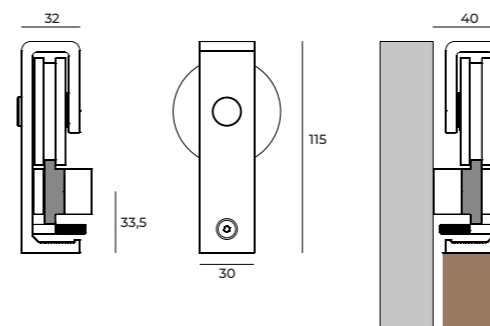
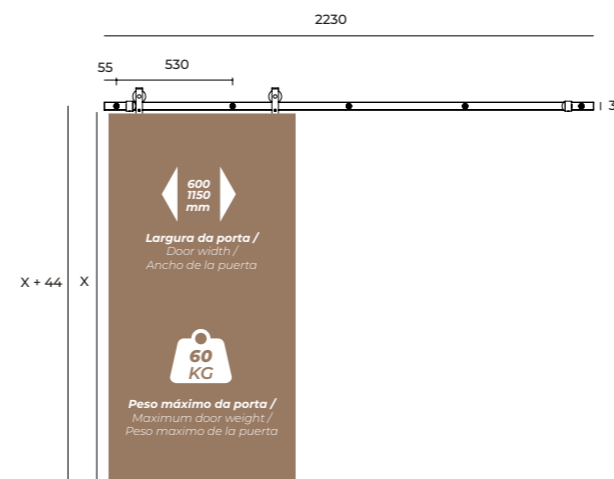
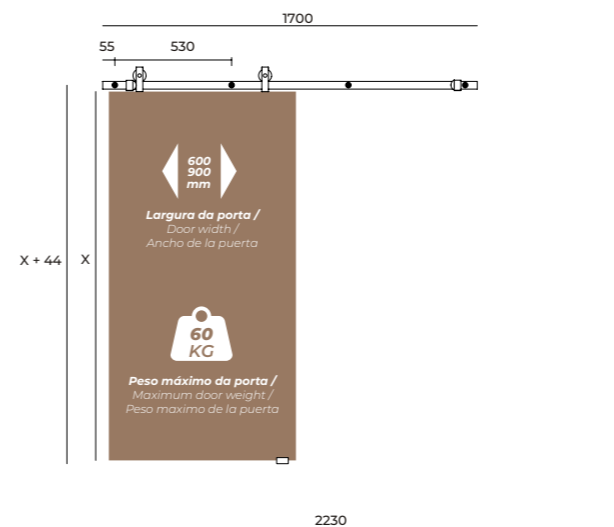

IN.15.900.S / Un.

Sistema manual com fecho suave para sistema charriot / Manual system with soft closing for charriot system / Sistema manual con cierre suave para sistema charriot.

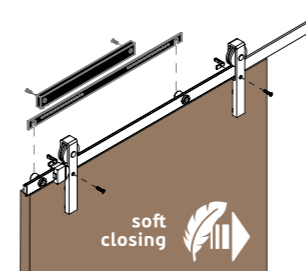

Charriot Inox color

For wooden doors

IN.15.901.I / Set
Chariot System 1700mm

IN.15.901.I.L / Set
Chariot System 2230mm

Sistema para porta de correr em madeira ou metálica de fixação à parede. Guia e carros em alumínio anodizado. Rodas em nylon com fibra de vidro e rolamento de esferas. Sistema desenvolvido para instalação fácil /

Wall-mounted sliding wooden or metallic door system. Guide and carriages in anodized aluminum. Nylon wheels with fiberglass and ball bearing. System developed for easy installation /

Sistema de puertas correderas en madera o metálica de fijación en la pared. Guía y carros en aluminio anodizado. Ruedas de nylon con fibra de cristal y rodamiento de bolas. Sistema desarrollado para una fácil instalación.

2x - **Roldanas** / Wheels / Ruedas
2x - **Batentes** / Stoppers / Frenos
1x - **Guia de pavimento** / Floor guide / Guía de suelo
1x - **Carril de alumínio** / Aluminium track / Guía de aluminio

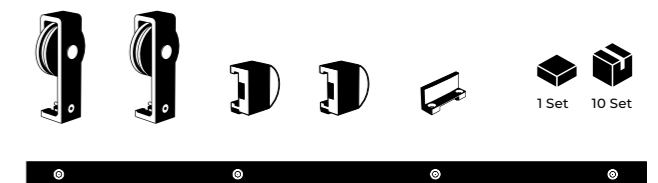

CHARRIOT BLACK COLOR

Sliding door system
for metallic and
wood doors



FOR WOOD OR METALLIC DOORS

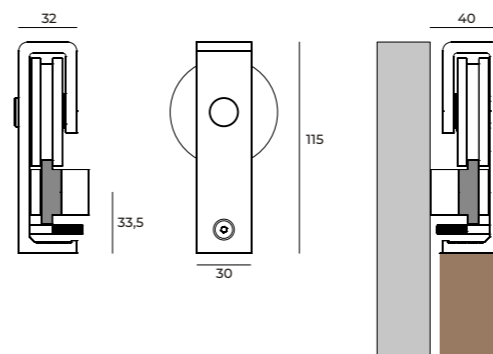
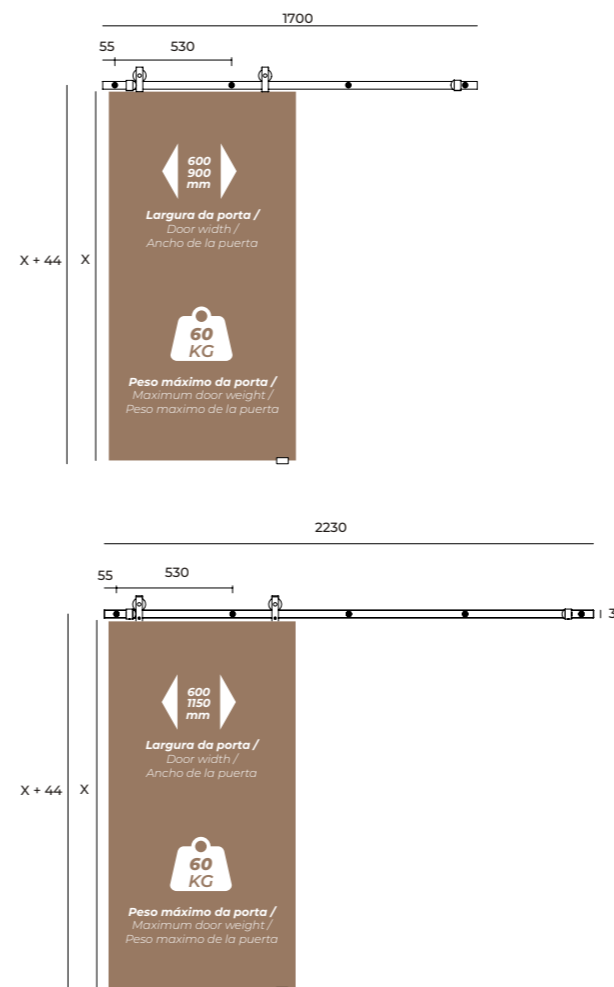

IN.15.900.S / Un.

Sistema manual com fecho suave para sistema charriot / Manual system with soft closing for charriot system / Sistema manual con cierre suave para sistema charriot.

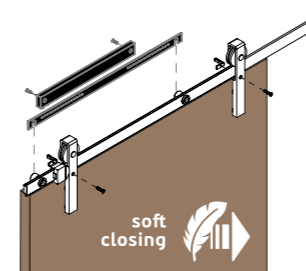

Charriot Black color

For wooden doors

IN.15.901.N / Set
Charriot System 1700mm

IN.15.901.N.L / Set
Charriot System 2230mm

Sistema para porta de correr em madeira ou metálica de fixação à parede. Guia e carros em alumínio anodizado. Rodas em nylon com fibra de vidro e rolamento de esferas. Sistema desenvolvido para instalação fácil /

Wall-mounted sliding wooden or metallic door system. Guide and carriages in anodized aluminum. Nylon wheels with fiberglass and ball bearing. System developed for easy installation /

Sistema de puertas correderas en madera o metálica de fijación en la pared. Guía y carros en aluminio anodizado. Ruedas de nylon con fibra de cristal y rodamiento de bolas. Sistema desarrollado para una fácil instalación.

2x - Roldanas / Wheels / Ruedas
2x - Batentes / Stoppers / Frenos
1x - Guia de pavimento / Floor guide / Guía de suelo
1x - Carril de alumínio / Aluminium track / Guía de aluminio

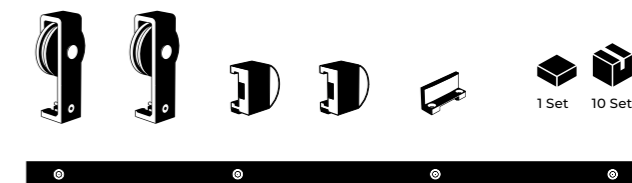

CHARRIOT BRONZE COLOR

Sliding door system
for metallic and
wood doors



FOR WOOD OR METALLIC DOORS

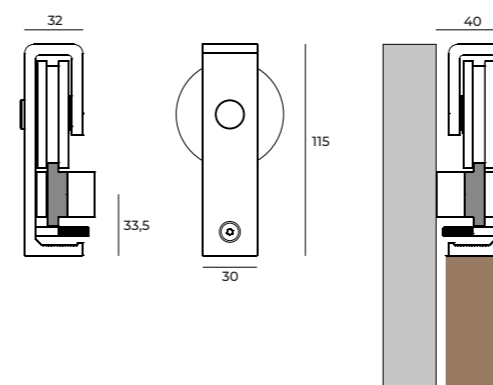
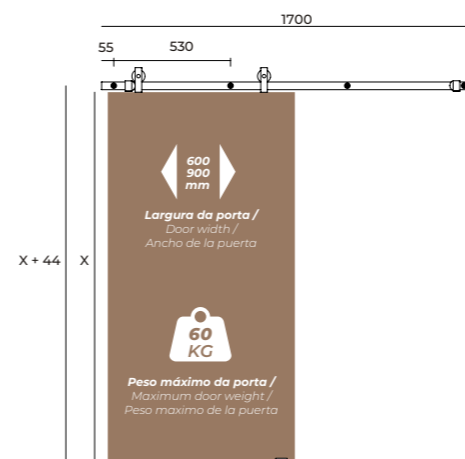

Charriot Bronze color

For wooden doors

IN.15.901.B / Set

Charriot System 1700mm

Sistema para porta de correr em madeira ou metálica de fixação à parede. Guia e carros em alumínio anodizado. Rodas em nylon com fibra de vidro e rolamento de esferas. Sistema desenvolvido para instalação fácil /

Wall-mounted sliding wooden or metallic door system. Guide and carriages in anodized aluminum. Nylon wheels with fiberglass and ball bearing. System developed for easy installation /

Sistema de portas correderas em madeira ou metálica de fijación en la pared. Guía y carros en aluminio anodizado. Ruedas de nylon con fibra de cristal y rodamiento de bolas. Sistema desarrollado para una fácil instalación.

- 2x - Roldanas / Wheels / Ruedas
- 2x - Batentes / Stoppers / Frenos
- 1x - Guia de pavimento / Floor guide / Guia de suelo
- 1x - Carril de alumínio / Aluminium track / Guia de aluminio

IN.15.900.S / Un.

Sistema manual com fecho suave para sistema charriot / Manual system with soft closing for charriot system / Sistema manual con cierre suave para sistema charriot.

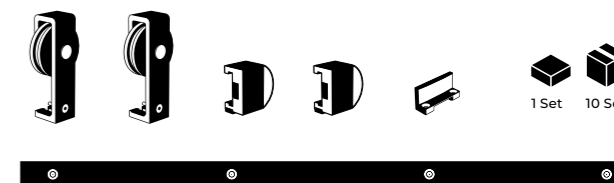
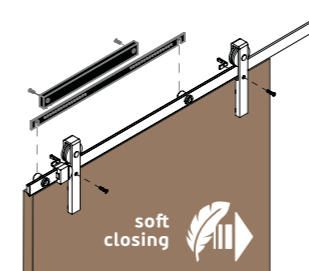

OFFSCREEN Light

Invisible system for sliding doors with soft closing.



Sistema invisível para portas de correr com fecho suave. Todo o sistema fica oculto na parte posterior e inferior da porta. A guia de alumínio é embutida na porta em conjunto com o sistema de amortecimento e fecho suave. O suporte oculto à parede permite o ajuste de ângulo da porta. No pavimento deslizam duas rodas com amortecedor em cada extremidade da porta.

Invisible system for sliding doors with soft closing. The entire system is concealed in the back and bottom of the door. The aluminium guide is embedded in the door together with the damping system and soft closing. The concealed wall bracket allows the angle of the door to be adjusted. Two wheels with shock absorbers slide on the floor at each end of the door /

Sistema invisible para puertas correderas con cierre suave. Todo el sistema está oculto en la parte posterior e inferior de la puerta. La guía de aluminio está empotrada en la puerta junto con el sistema de amortiguación y el cierre suave. El soporte mural oculto permite ajustar el ángulo de la puerta. Dos ruedas con amortiguadores se deslizan por el suelo en cada extremo de la puerta.

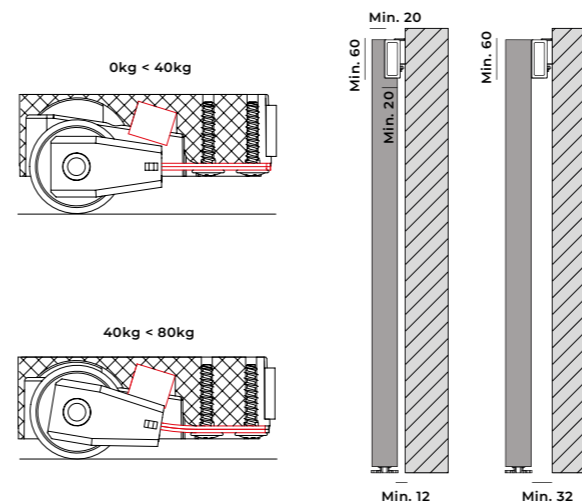

Na versão OFFSCREEN LIGHT, o pavimento tem de ser regular e nivelado de forma a garantir um bom funcionamento das rodas posicionadas na base da porta.

In the OFFSCREEN LIGHT version the floor must be regular and level in order to ensure a good function of the wheels positioned at the base of the door.

En la versión OFFSCREEN LIGHT el pavimento tiene que ser regular y nivelado para garantizar un buen funcionamiento de las ruedas colocadas en la base de la puerta.

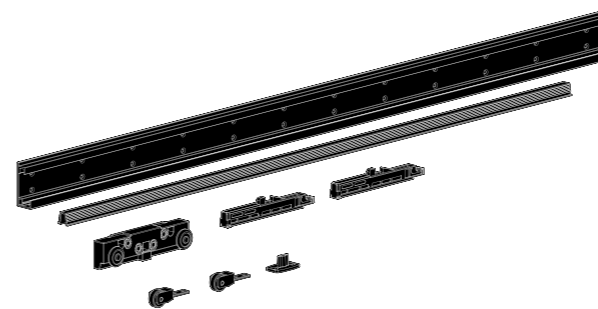

- 1x - Roldana superior / Upper wheel / Rueda superior
- 2x - Roldanas inferiores / Lower wheels / Ruedas inferiores
- 2x - Fechos suaves / Soft close / Cierres suaves.
- 1x - Guia de pavimento / Floor guide / Guía de suelo
- 2x - Carril de alumínio / Aluminium track / Guía de aluminium
- 1x - Guia inferior de porta / Lower door guide / Guía inferior puerta.



OFFSCREEN Light

for wooden sliding doors

IN.15.452.1100 / Set
Offscreen light 910-1100mm

IN.15.452.1800 / Set
Offscreen light 910-1800mm

Sistema invisível para portas de correr com fecho suave. Todo o sistema fica oculto na parte posterior e inferior da porta. A guia de alumínio é embutida na porta em conjunto com o sistema de amortecimento e fecho suave. O suporte oculto à parede permite o ajuste de ângulo da porta. No pavimento deslizam duas rodas com amortecedor em cada extremidade da porta /

System for invisible sliding doors with soft closing. The entire system is concealed in the back and bottom of the door. The aluminium guide is embedded in the door together with the damping system and soft closing. The concealed wall bracket allows the angle of the door to be adjusted. Two wheels with shock absorbers slide on the floor at each end of the door /

Sistema invisible para puertas correderas con cierre suave. Todo el sistema está oculto en la parte posterior e inferior de la puerta. La guía de aluminio está empotrada en la puerta junto con el sistema de amortiguación y el cierre suave. El soporte mural oculto permite ajustar el ángulo de la puerta. Dos ruedas con amortiguadores se deslizan por el suelo en cada extremo de la puerta.



OFFSCREEN Light 1100



FOR WOOD OR METALLIC DOORS

POSIÇÃO STANDARD /
STANDARD POSITION /
POSICIÓN ESTÁNDAR

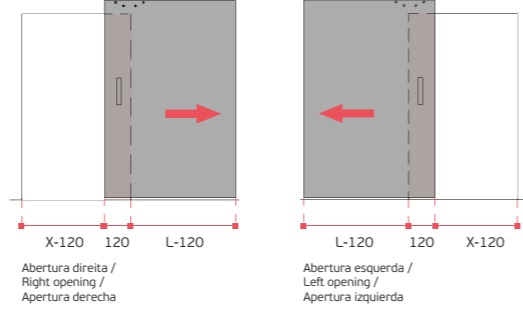
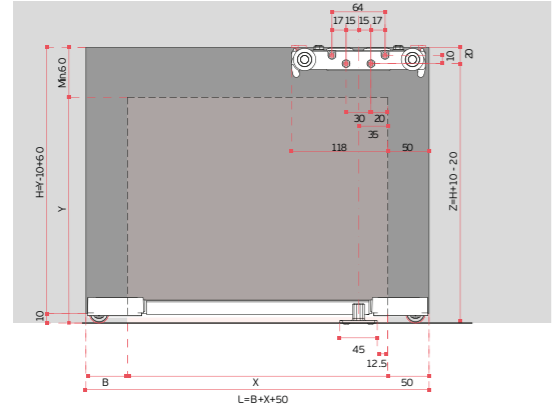

IN.15.452.1100
B=0
X= MIN. 800 (L=850) / X= MAX. 1050 (L=1100)
B=50
X= MIN. 800 (L=900) / X= MAX. 1000 (L=1100)

POSIÇÃO INTERMÉDIA /
INTERMEDIATE POSITION /
POSICIÓN INTERMEDIA.

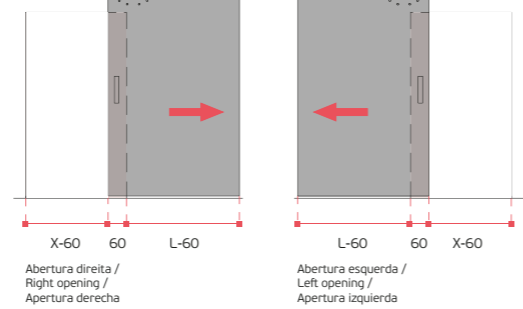
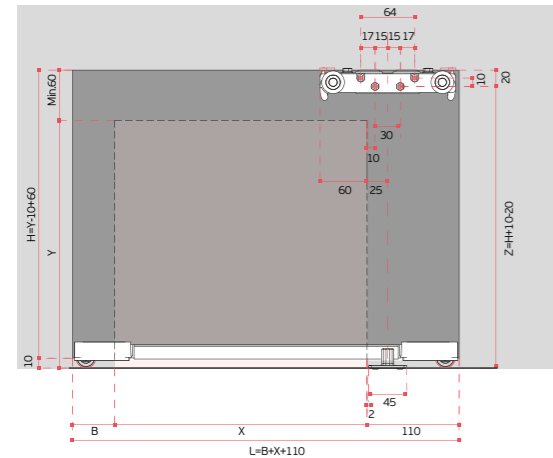

IN.15.452.1100
B=0
X= MIN. 740 (L=850) / X= MAX. 990 (L=1100)
B=50
X= MIN. 740 (L=900) / X= MAX. 940 (L=1100)

POSIÇÃO DE ABERTURA TOTAL /
TOTAL OPENING POSITION /
POSICIÓN TOTAL DE APERTURA

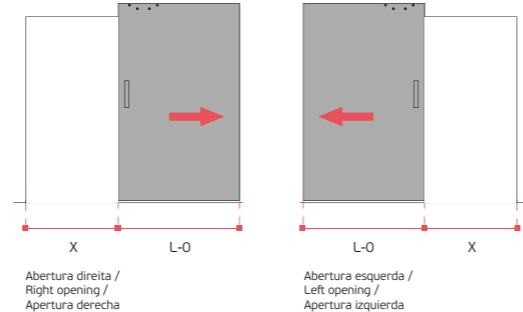
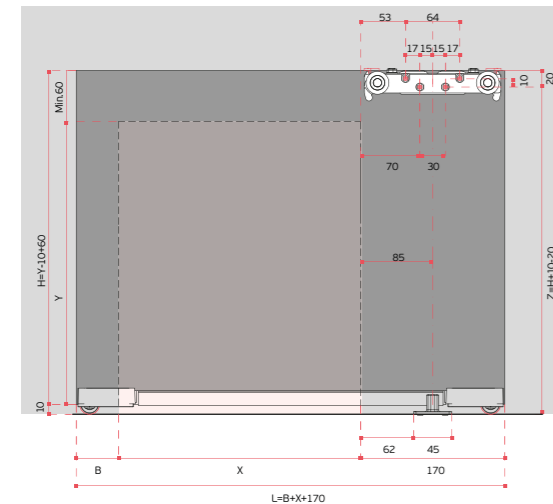

IN.15.452.1100
B=0
X= MIN. 680 (L=850) / X= MAX. 930 (L=1100)
B=50
X= MIN. 680 (L=900) / X= MAX. 880 (L=1100)

OFFSCREEN Light 1800



FOR WOOD OR METALLIC DOORS

POSIÇÃO STANDARD /
STANDARD POSITION /
POSICIÓN ESTÁNDAR

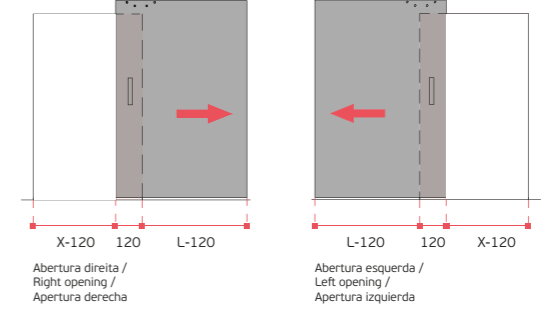
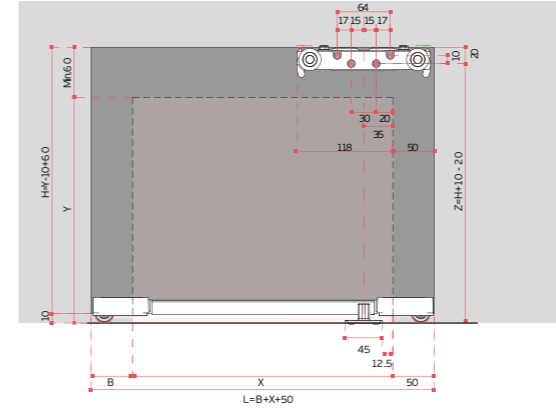

IN.15.452.1800
B=0
X= MIN. 800 (L=850) / X= MAX. 1750 (L=1800)
B=50
X= MIN. 800 (L=900) / X= MAX. 1700 (L=1800)

POSIÇÃO INTERMÉDIA /
INTERMEDIATE POSITION /
POSICIÓN INTERMEDIA.

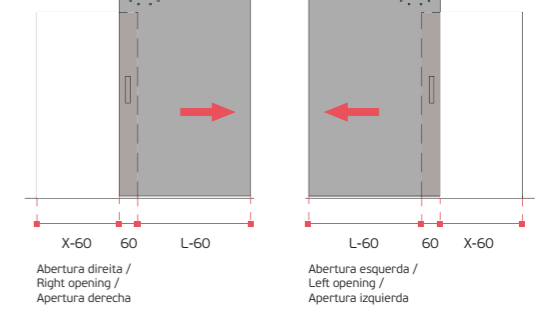
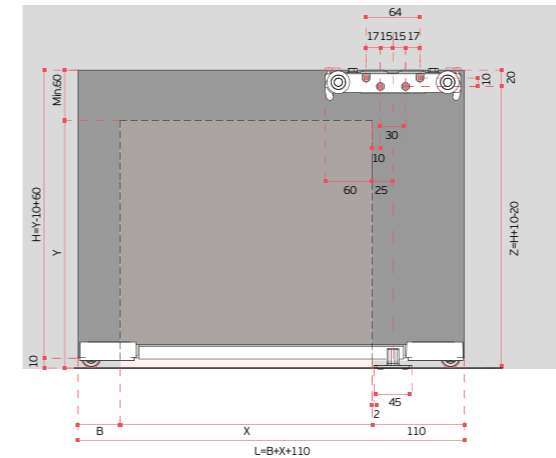

IN.15.452.1800
B=0
X= MIN. 740 (L=850) / X= MAX. 1690 (L=1800)
B=50
X= MIN. 740 (L=900) / X= MAX. 1640 (L=1800)

POSIÇÃO DE ABERTURA TOTAL /
TOTAL OPENING POSITION /
POSICIÓN TOTAL DE APERTURA

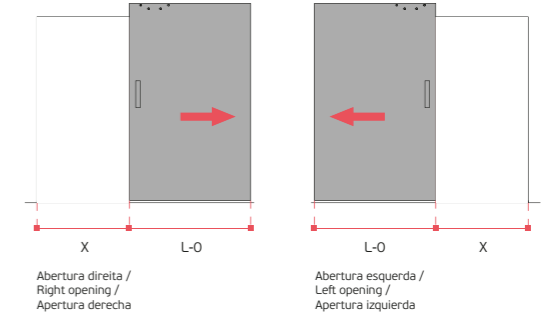
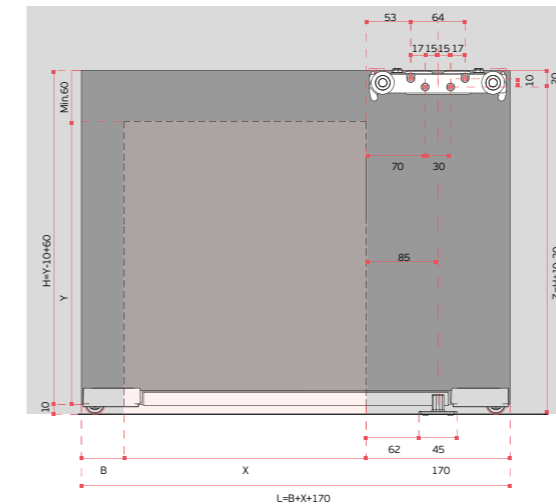

IN.15.452.1800
B=0
X= MIN. 680 (L=850) / X= MAX. 1630 (L=1800)
B=50
X= MIN. 680 (L=900) / X= MAX. 1580 (L=1800)

K80 standard for wooden sliding doors

Sistema de porta de correr de madeira com mecanismo de encaixe e ajuste efetuado na parte lateral da porta / Wooden sliding door system with mechanism to fit and adjust on the side of the door / Sistema de puertas correderas de madera con mecanismo de bloqueo y ajuste realizado en el lateral de la puerta.

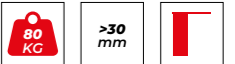
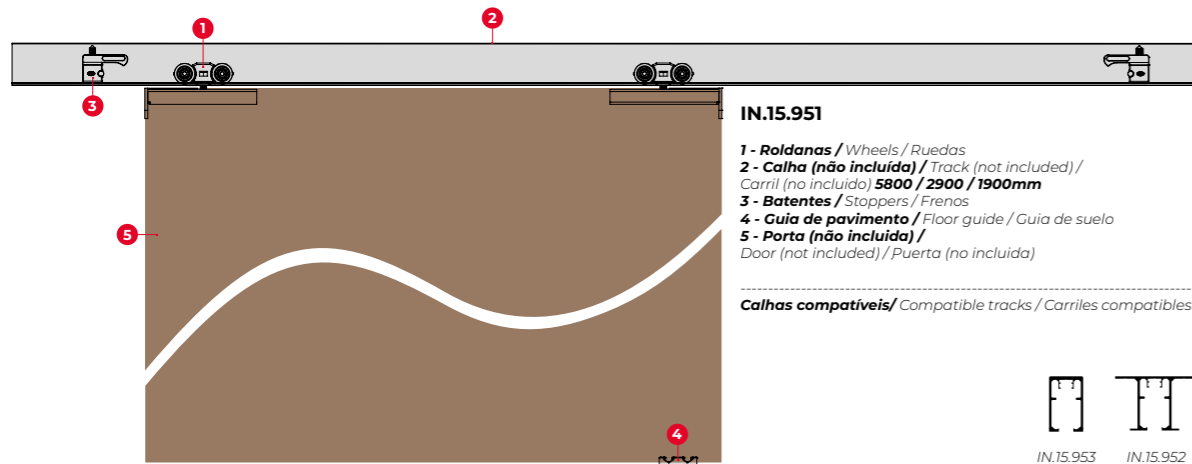
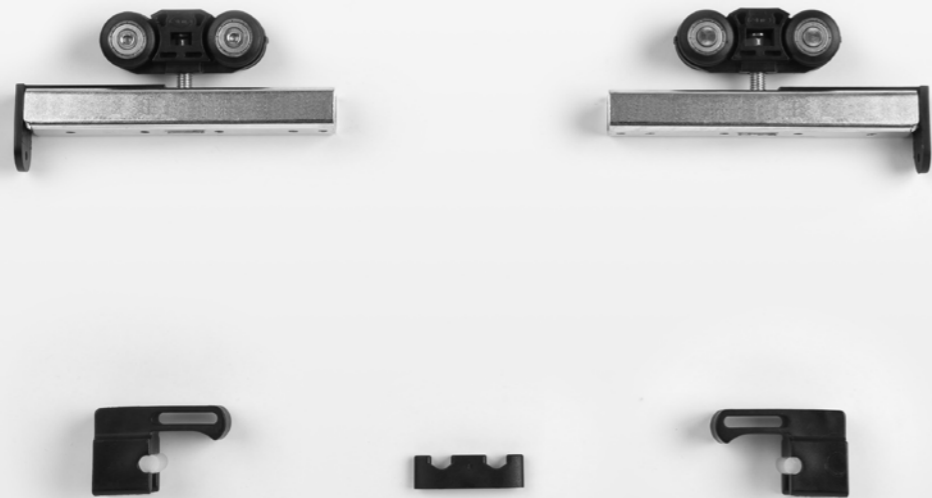

FOR WOOD OR METALLIC DOORS

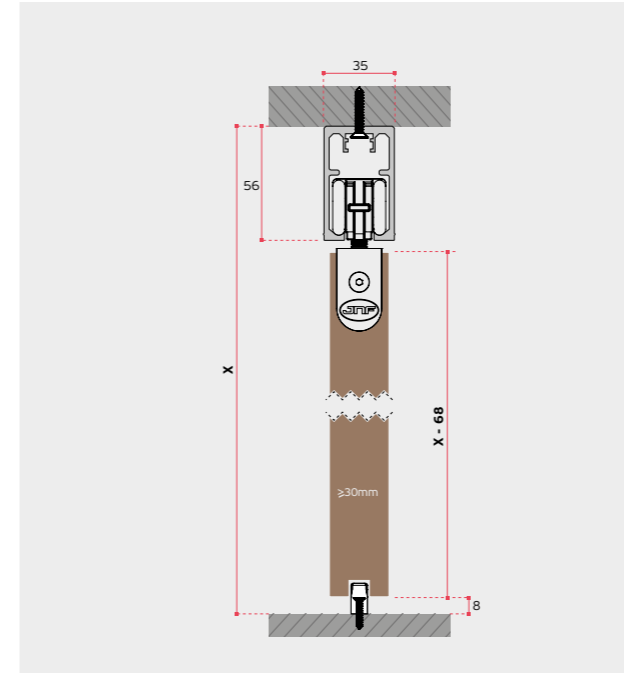

K80 for wood Ceiling installation

IN.15.951 / Set
Sistema de porta de correr de madeira com mecanismo de encaixe e ajuste efetuado na parte lateral da porta /
Wooden sliding door system with mechanism to fit and adjust on the side of the door /
Sistema de puertas correderas de madera con mecanismo de bloqueo y ajuste realizado en el lateral de la puerta.



2x - Roldanas / Wheels / Ruedas
2x - Batentes / Stoppers / Frenos
1x - Guia de pavimento / Floor guide / Guia de suelo

IN.15.953.1900 / Un.
IN.15.953.2900 / Un.
IN.15.953.5800 / Un.



Carril superior / Upper track / Carril superior
1900 / 2900 / 5800mm.

EN1527 ■ 5 | 2 | - | 1 | 3 | - | 1 | 2

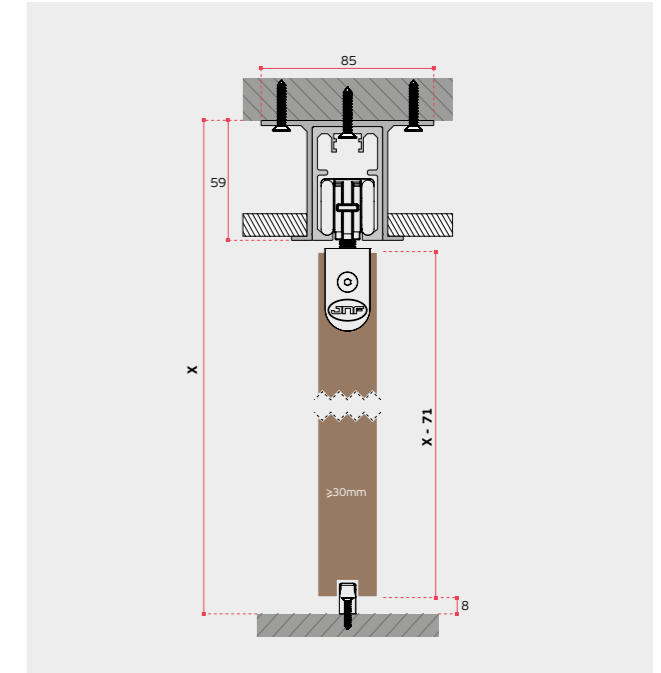
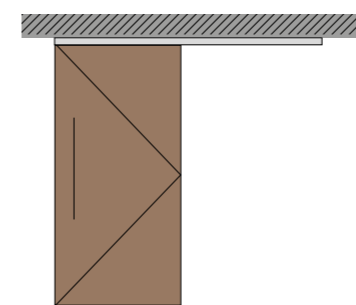

K80 for wood False ceiling installation

IN.15.951 / Set
Sistema de porta de correr de madeira com mecanismo de encaixe e ajuste efetuado na parte lateral da porta /
Wooden sliding door system with mechanism to fit and adjust on the side of the door /
Sistema de puertas correderas de madera con mecanismo de bloqueo y ajuste realizado en el lateral de la puerta.



2x - Roldanas / Wheels / Ruedas
2x - Batentes / Stoppers / Frenos
1x - Guia de pavimento / Floor guide / Guia de suelo

IN.15.952.1900 / Un.
IN.15.952.2900 / Un.
IN.15.952.5800 / Un.



Carril superior / Upper track / Carril superior
1900 / 2900 / 5800mm.

EN1527 ■ 5 | 2 | - | 1 | 3 | - | 1 | 2

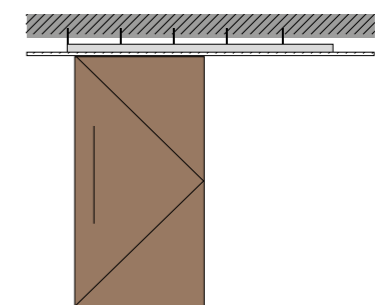

K80 soft closing for wooden sliding doors

Sistema de porta de correr de madeira com fecho suave.
Mecanismo de encaixe e ajuste efetuado na parte lateral da porta /
Soft close wooden sliding door system. Mechanism
to fit and adjust on the side of the door / Sistema de puertas
correderas de madera con cierre suave con mecanismo de
bloqueo y ajuste realizado en el lateral de la puerta.

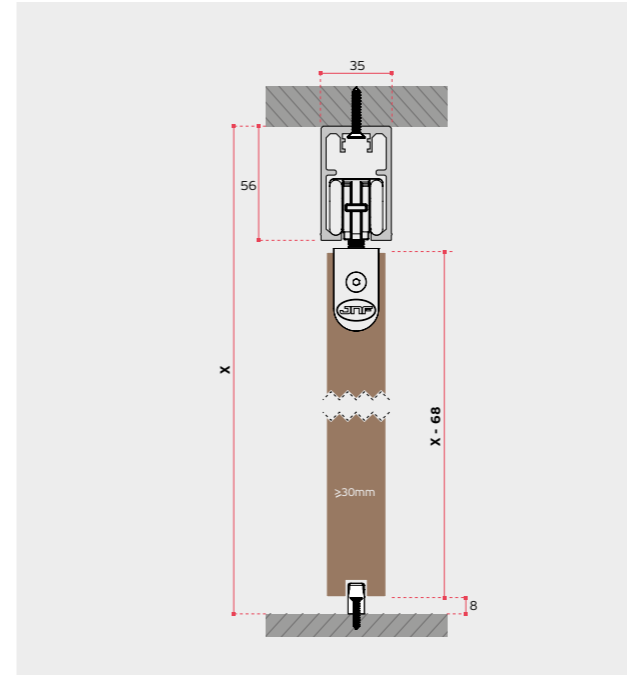
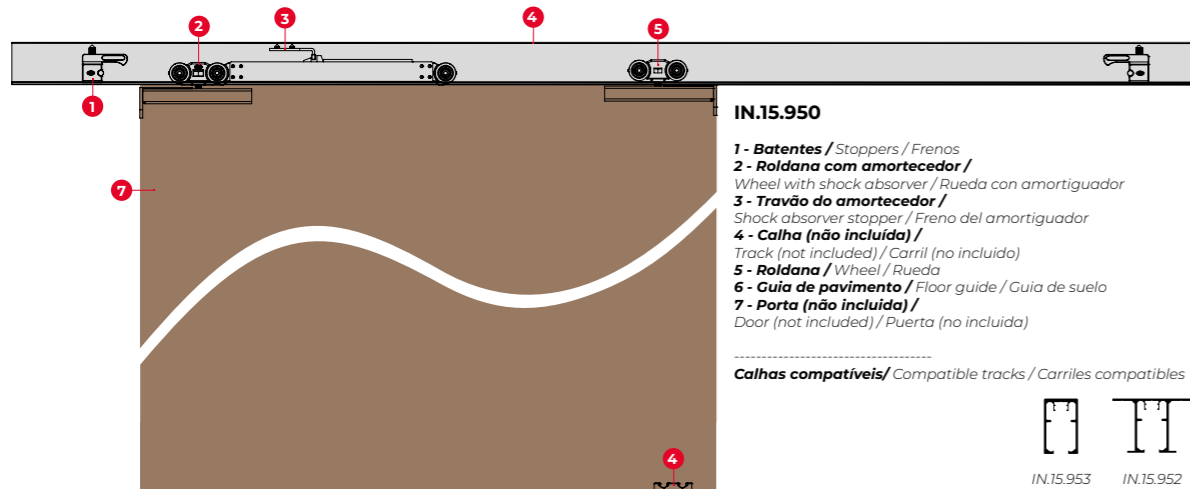
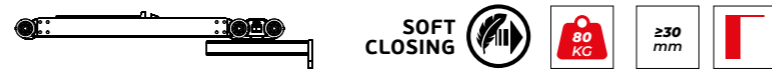

K80 Soft for wood Ceiling installation

IN.15.950 / Set
Sistema de porta de correr de madeira com fecho suave. Mecanismo de encaixe e ajuste efetuado na parte lateral da porta /
Soft close wooden sliding door system. Mechanism to fit and adjust on the side of the door / Sistema de puertas correderas de madera con cierre suave con mecanismo de bloqueo y ajuste realizado en el lateral de la puerta.

- 1x - Roldanas / Wheels / Ruedas
- 1x - Roldana com amortecedor / Wheel with shock absorber / Ruedas con amortiguador.
- 2x - Batentes / Stoppers / Frenos
- 1x - Guia de pavimento / Floor guide / Guia de suelo

IN.15.953.1900 / Un.
IN.15.953.2900 / Un.
IN.15.953.5800 / Un.

Carril superior / Upper track / Carril superior
1900 / 2900 / 5800mm.

EN1527 52-113-112

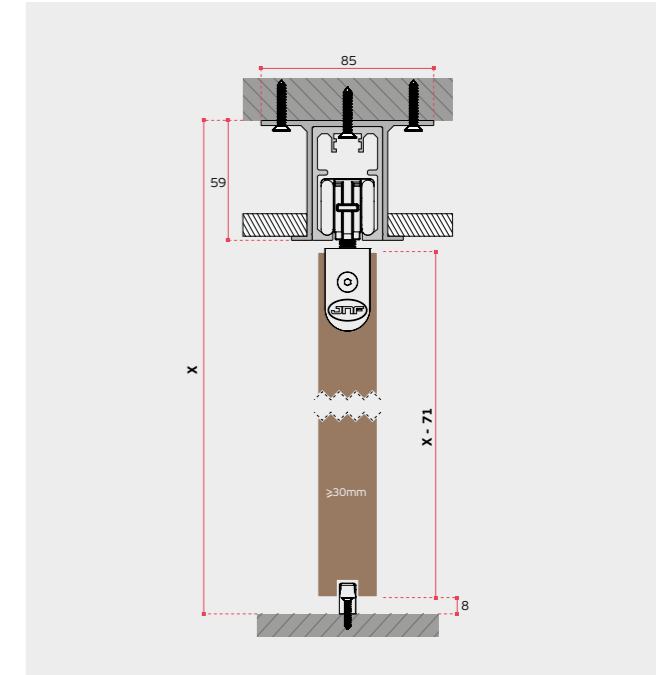
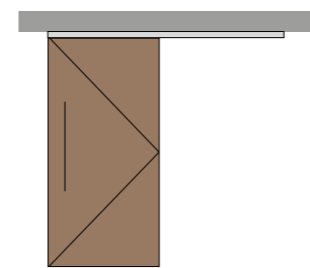

K80 Soft for wood False ceiling installation

IN.15.950 / Set
Sistema de porta de correr de madeira com fecho suave. Mecanismo de encaixe e ajuste efetuado na parte lateral da porta /
Soft close wooden sliding door system. Mechanism to fit and adjust on the side of the door / Sistema de puertas correderas de madera con cierre suave con mecanismo de bloqueo y ajuste realizado en el lateral de la puerta.

- 1x - Roldanas / Wheels / Ruedas
- 1x - Roldana com amortecedor / Wheel with shock absorber / Ruedas con amortiguador.
- 2x - Batentes / Stoppers / Frenos
- 1x - Guia de pavimento / Floor guide / Guia de suelo

IN.15.952.1900 / Un.
IN.15.952.2900 / Un.
IN.15.952.5800 / Un.

Carril superior / Upper track / Carril superior
1900 / 2900 / 5800mm.

EN1527 52-113-112

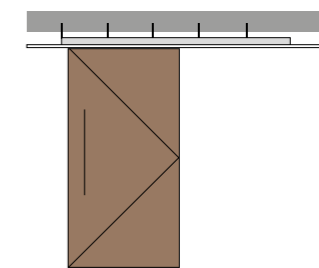

IN.15.40K for wooden sliding doors

Sistema para portas de correr de madeira.
Sliding door system for wooden doors.
Sistema para puertas correderas de madera.

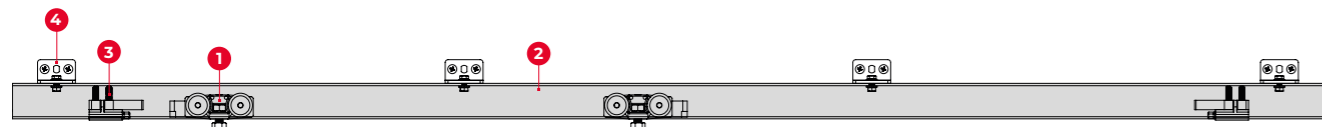
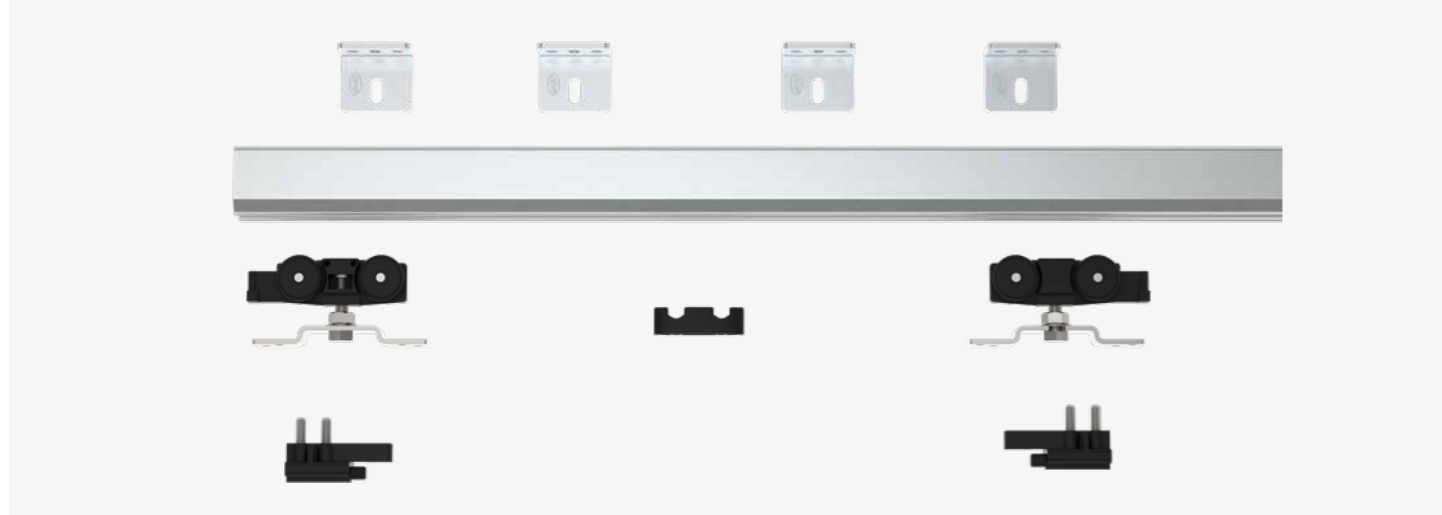

IN.15.40K

- 1 - Roldanas / Wheels / Ruedas
- 2 - Calha superior / Track / Carril 2000mm
- 3 - Batentes / Stoppers / Frenos
- 4 - Suportes de parede / Wall supports / Soportes de pared
- 5 - Guia de pavimento / Floor guide / Guia de suelo
- 6 - Porta (não incluída) / Door (not included) / Puerta (no incluida)

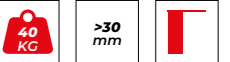

FOR WOOD OR METALLIC DOORS

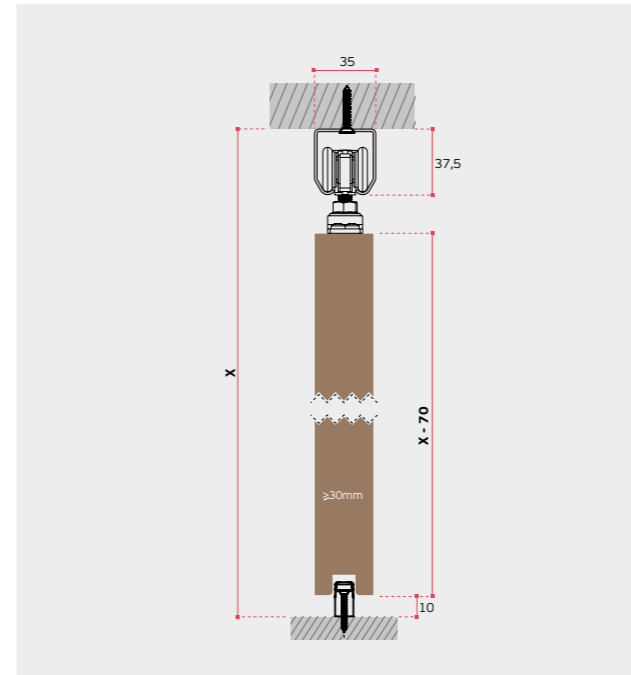

IN.15.40K Ceiling installation

IN.15.40K / Set

Sistema para portas de correr de madeira /
Sliding door system for wooden doors /
Sistema para puertas correderas de madera.



- 1x - Calha superior 2000mm /
Upper track 2000mm / Carril superior 2000mm
- 2x - Roldanas / Wheels / Ruedas
- 2x - Batentes / Stoppers / Frenos
- 4x - Suportes de parede / Wall supports / Soportes de pared
- 1x - Guia de pavimento / Floor guide / Guia de suelo

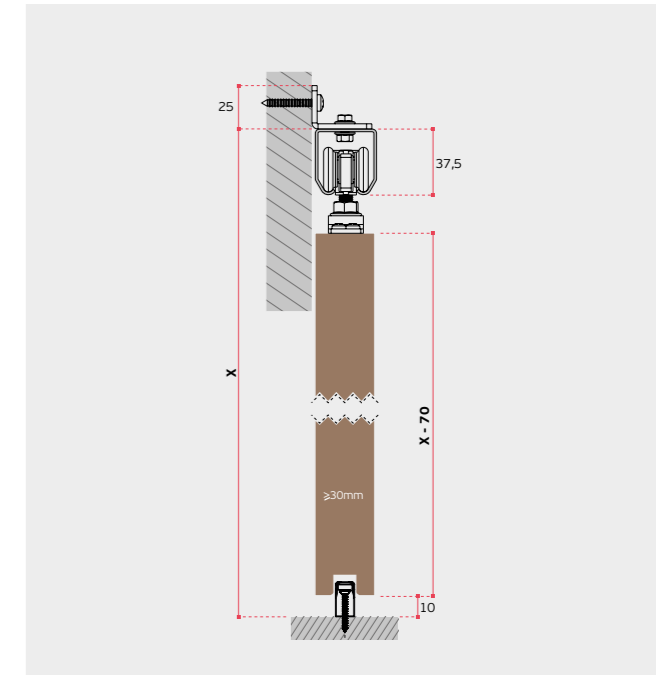
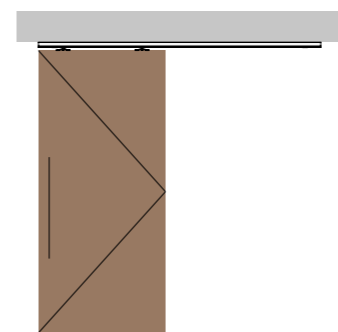

IN.15.40K Wall installation

IN.15.40K / Set

Sistema para portas de correr de madeira /
Sliding door system for wooden doors /
Sistema para puertas correderas de madera.



- 1x - Calha superior 2000mm /
Upper track 2000mm / Carril superior 2000mm
- 2x - Roldanas / Wheels / Ruedas
- 2x - Batentes / Stoppers / Frenos
- 4x - Suportes de parede / Wall supports / Soportes de pared
- 1x - Guia de pavimento / Floor guide / Guia de suelo

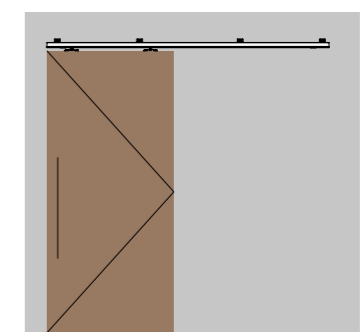

IN.15.40S for wooden sliding doors

Sistema para portas de correr de madeira.
Sliding door system for wooden doors.
Sistema para puertas correderas de madera.

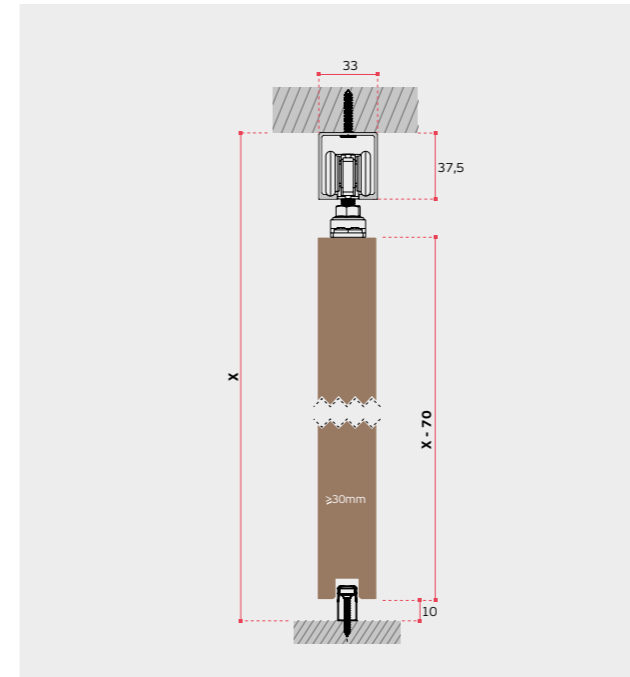
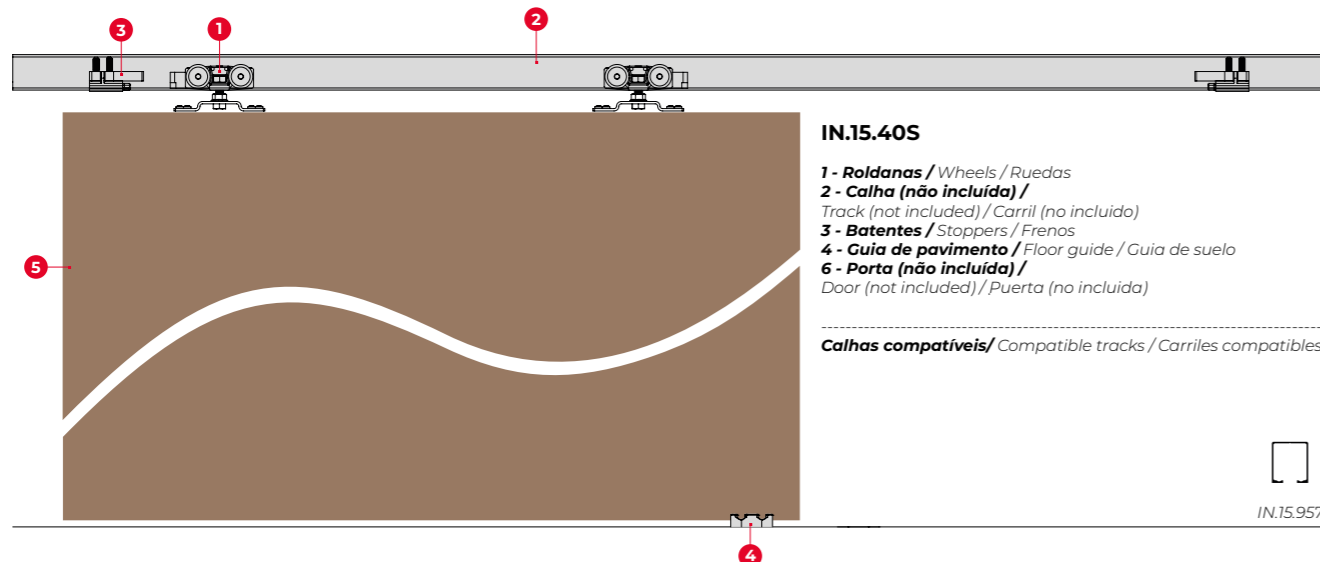

IN.15.40S Ceiling installation

IN.15.40S / Set

Sistema para portas de correr de madeira / Sliding door system for wooden doors / Sistema para puertas correderas de madera.



2x - Roldanas / Wheels / Ruedas
2x - Batentes / Stoppers / Frenos
1x - Guia de pavimento / Floor guide / Guia de suelo

IN.15.957.1900 / Un.
IN.15.957.2900 / Un.
IN.15.957.5800 / Un.
Carril superior / Upper track / Carril superior
1900 / 2900 / 5800mm.

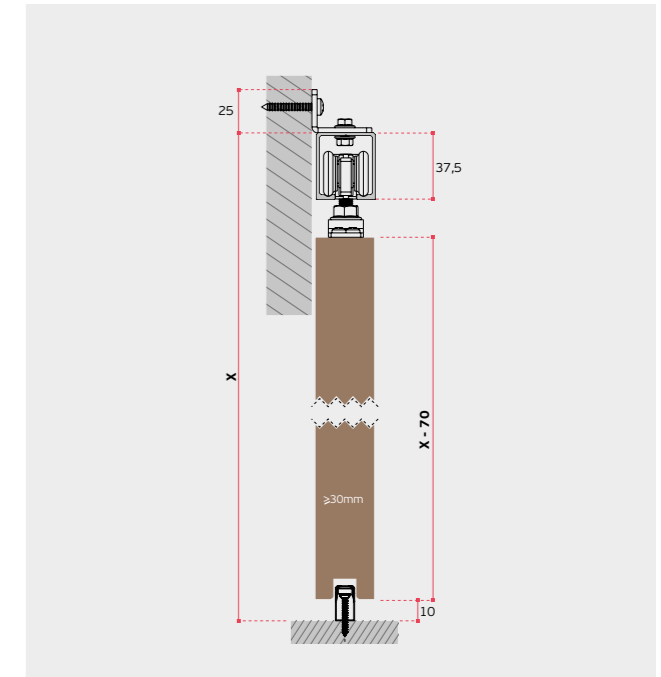
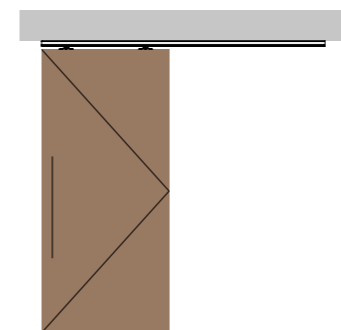

IN.15.40S Wall installation

IN.15.40S / Set

Sistema para portas de correr de madeira / Sliding door system for wooden doors / Sistema para puertas correderas de madera.



2x - Roldanas / Wheels / Ruedas
2x - Batentes / Stoppers / Frenos
1x - Guia de pavimento / Floor guide / Guia de suelo

IN.15.957.1900 / Un.
IN.15.957.2900 / Un.
IN.15.957.5800 / Un.
Carril superior / Upper track / Carril superior
1900 / 2900 / 5800mm.

IN.15.255.2 / Un.
Suportes de parede / Wall supports / Soportes de parede
(4 unidades / 4 units / 4 unidades)

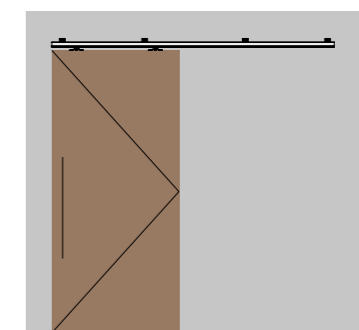

IN.15.100S for wooden sliding doors

Sistema para portas de correr de madeira.
Sliding door system for wooden doors.
Sistema para puertas correderas de madera.

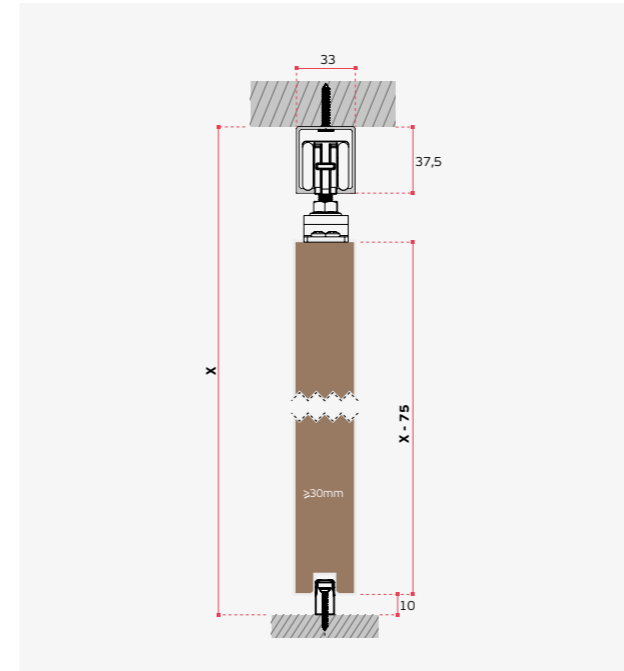
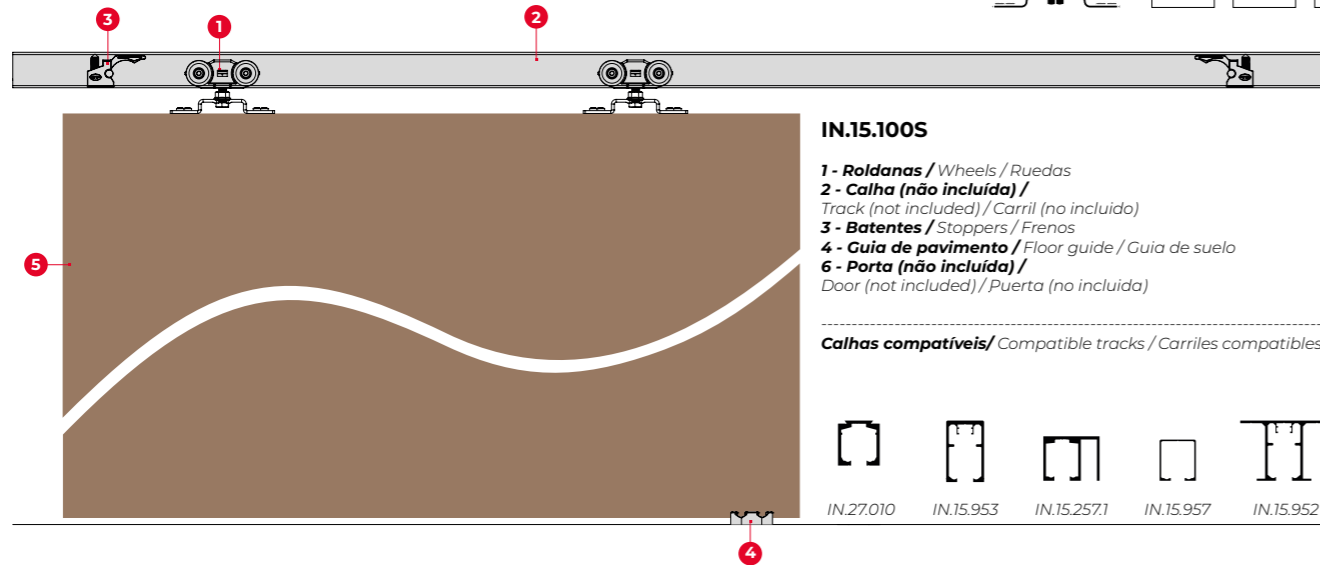
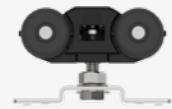

IN.15.100S Ceiling installation

IN.15.100S / Set

Sistema para portas de correr de madeira / Sliding door system for wooden doors / Sistema para puertas correderas de madera.



2x - Roldanas / Wheels / Ruedas
2x - Batentes / Stoppers / Frenos
1x - Guia de pavimento / Floor guide / Guia de suelo

IN.15.957.1900 / Un.
IN.15.957.2900 / Un.
IN.15.957.5800 / Un.

Carril superior / Upper track / Carril superior
1900 / 2900 / 5800mm.

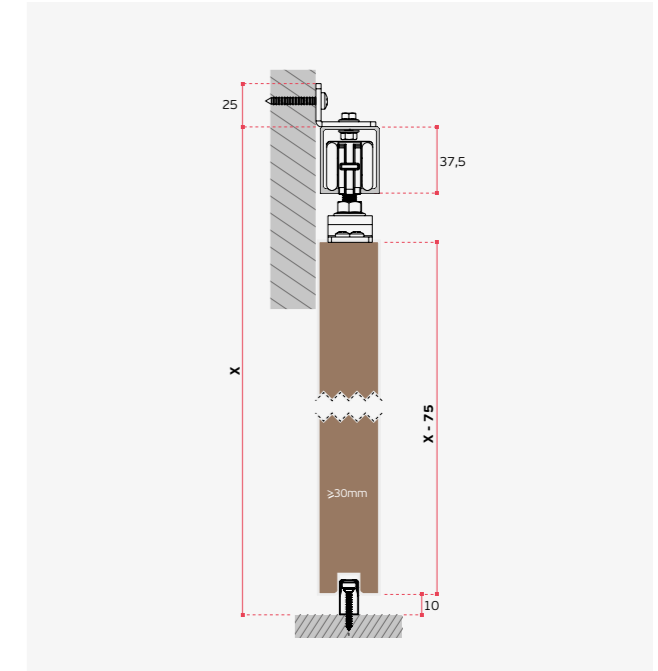
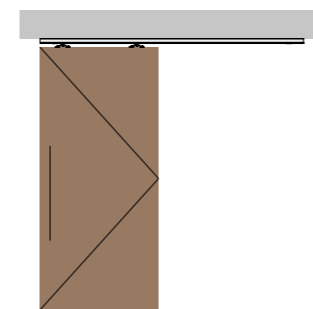

IN.15.100S Wall installation

IN.15.100S / Set

Sistema para portas de correr de madeira / Sliding door system for wooden doors / Sistema para puertas correderas de madera.



2x - Roldanas / Wheels / Ruedas
2x - Batentes / Stoppers / Frenos
1x - Guia de pavimento / Floor guide / Guia de suelo

IN.15.957.1900 / Un.
IN.15.957.2900 / Un.
IN.15.957.5800 / Un.

Carril superior / Upper track / Carril superior
1900 / 2900 / 5800mm.

IN.15.255.2 / Un.
Suportes de parede / Wall supports / Soportes de parede
(4 unidades / 4 units / 4 unidades)

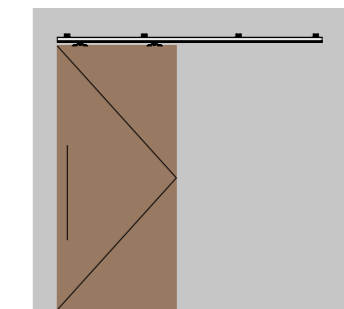

8

SISTEMAS DE FECHO LOCKING SYSTEMS SISTEMAS DE CIERRE.

8.1
FECHADURAS DE SEGURANÇA /
SECURITY LOCKS /
CERRADURAS DE SEGURIDAD.

8.2
FECHADURA DE SOBREPOR /
RIM LOCK /
CERRADURA DE SOBREPONER.

8.3
FECHADURAS MAGNÉTICAS /
MAGNETIC LOCKS /
CERRADURAS MAGNETICAS.

8.4
SÉRIE 790 /
790 SERIES / SERIE 790.

8.5
SÉRIE 820 COM CAIXA UNIFICADA /
820 SERIES WITH UNIFIED CASE /
SERIE 820 CON CAJA UNIFICADA.

8.6
FECHADURAS PARA INDÚSTRIA /
INDUSTRY LOCKS /
CERRADURAS PARA INDUSTRIA.

8.7
SÉRIE 720
720 SERIES / SERIE 720.

8.8
SERIE 700 /
700 SERIES / SERIE 700.

8.9
FECHADURA DE EMBUTIR /
MORTISE DOOR LOCK /
CERRADURA DE EMBUTIR.

8.10
FECHADURAS PARA PORTAS DE
CORRER / LOCKS FOR SLIDING
DOORS / CERRADURAS PARA
PUERTAS CORREDERAS.

8.11
FECHADURAS AUXILIARES /
AUXILIARY LOCKS /
CERRADURAS AUXILIARES.

8.12
CILINDRO DE SEGURANÇA /
SECURITY CYLINDER /
CILINDRO DE SEGURIDAD.

8.13
CILINDRO STANDARD /
STANDARD CYLINDER /
CILINDRO ESTANDAR.

8.14
CILINDRO BÁSICO
BASIC CYLINDER /
CILINDRO BASICO

8.15
FECHADURA ELECTROMAGNÉTICA /
ELECTROMAGNETIC LOCK /
CERRADURA ELECTROMAGNETICA.

8.16
FECHADURA ELÉCTRICA
DROP PIN / DROP PIN LOCK /
CERRADURA ELECTRICA DROP PIN.

8.17
TESTA ELECTRICA /
ELECTRIC STRIKE /
CERRADERO ELECTRICO.

8.18
FORTE DE ALIMENTAÇÃO /
POWER SUPPLY /
FUENTE DE ALIMENTACIÓN.

8.19
BARRAS ANTI-PÂNICO /
ANTIPANIC EXIT DEVICES /
CERRADURA ANTIPÁNICO.

8.20
FECHO DE EMBUTIR AUTOMÁTICO /
AUTOMATIC DEADBOLT / CERRADURA
AUTOMATICA DE EMBUTIR.

8.21
SECTOR DE FECHO /
DOOR COORDINATORS /
SELECTOR DE CIERRE.

8.22
MOLAS DE SOBREPOR /
OVERHEAD FLOOR CLOSERS /
CIERRA PUERTAS DE SOBREPONER.

8.23
MOLAS DE PAVIMENTO /
FLOOR CLOSERS /
CIERRA PUERTAS DE SUELO

8.24
VEDA PORTAS AUTOMÁTICOS /
AUTOMATIC DROP SEALS /
VEDA PUERTAS AUTOMATICO.



HIGH SECURITY

FECHADURA DE ALTA SEGURANÇA CERRADURA ALTA SEGURIDAD

A série de segurança foi criada para ser utilizada em portas que estão sujeitas a uma utilização elevada /

The security lock series was designed to be used on doors that are subject to high usage /

La serie de cerraduras de seguridad fue creada para ser aplicada en puertas que se utilizan de un modo elevado.

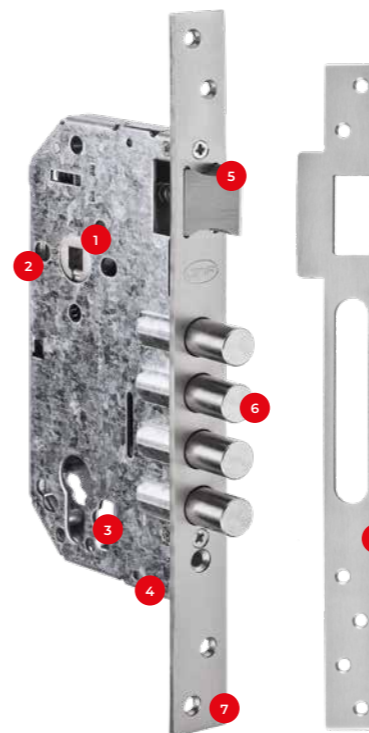

A série de segurança foi criada para ser utilizada em portas que estão sujeitas a uma utilização elevada / Security locks series was created to be applied in doors that have high use / La serie de cerraduras de seguridad fue creada para ser aplicada en puertas que se utilizan de un modo elevado.

1. Quadra em aço inox com mola interior para eliminação da folga entre o puxador e a quadra / Stainless steel handle square hole with a internal spring to avoid any gap between the spindle and the lock / Nueca en acero inox con muelle interior para eliminar la holgura entre la manilla e la nueca.

2. Furação para fixação do puxador / Handle fixing holes / Agujeros para tornillos pasantes.

3. Possível aplicação de diversos escudetes de segurança / Possible to install different security cylinder key holes / Posible de aplicar distintos bocallaves de seguridad para cilindro.

4. Caixa fechada / Closed lock case / Caja cerrada.

5. Trinco reversível em aço inox EN 1.4301 / Adjustable latch made in stainless steel EN 1.4301 / Picaporte reversible en acero inox EN 1.4301.

6. Trancas de segurança em aço inox EN 1.4301 / Security dead bolt made in stainless steel EN 1.4301 / Bullones de seguridad en acero inox EN 1.4301.

7. Frente em inox escovado apenas 23mm de largura e 3mm de espessura / Front only in steel brushed 23mm wide and 3mm thick / Frente en acero satin sólo con 23mm de ancho y 3mm de espesor.

8. Chapa testa 2,5mm de espessura / Strike plate with 2,5mm thickness / Cerradero con 2,5mm espesor.



High security lock 1 Point - Stainless steel

IN.20.004 / Un.

Fechadura de embutir de alta segurança /
High security mortise lock /
Cerradura de empustrar de alta seguridad.

EN 1.4301 - AISI 304
Satinado / Satin

EN12209 **3** H 5 0 0 C 7 B C 3 0

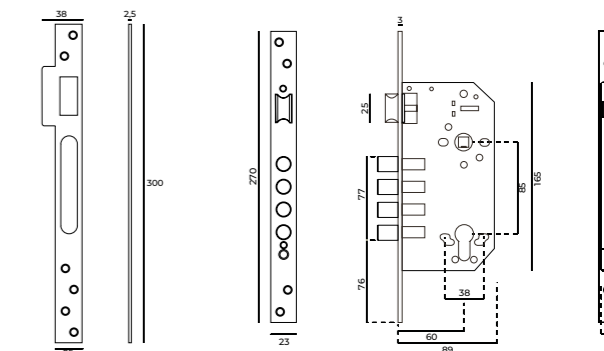

HIGH SECURITY

Fechadura de segurança que concilia a robustez com a suavidade do sistema de trinco magnético que permite um funcionamento silencioso e suave.

Security lock that combines robustness with the smoothness of the magnetic latch system that allows silent and smooth operation.

Cerradura de seguridad que combina robustez con la suavidad del sistema de cierre magnético que permite un funcionamiento silencioso y suave.

1. Trancas de segurança em aço inox EN 1.4301 / Security dead bolt made in stainless steel EN 1.4301 / Bullones de seguridad en acero inox EN 1.4301.

2. Quadra em aço inox com mola interior para eliminação da folga entre o puxador e a quadra / Stainless steel handle square hole with a internal spring to avoid any gap between the and the lock / Nueca en acero inox con muelle interior para eliminar la holgura entre la manilla e la nueca.

3. Furação para fixação do puxador / Handle fixing holes / Agujeros para tornillos pasantes.

4. Possível aplicação de diversos escudetes de segurança / Possible to instal different security cylinder key holes / Posible de aplicar distintos bocallaves de seguridad para cilindro.

5. Caixa fechada / Closed lock case / Caja cerrada.

6. Trinco reversível em aço inox EN 1.4301 / Adjustable latch made in stainless steel EN 1.4301 / Picaporte reversible en acero inox EN 1.4301.

7. Trancas de segurança em aço inox EN 1.4301 / Security dead bolt made in stainless steel EN 1.4301 / Bullones de seguridad en acero inox EN 1.4301.

8. Frente em inox escovado 20mm de largura e 10 mm de espessura / Front only in steel brushed 20mm wide and 10mm thick / Frente en acero satin sólo con 20mm de ancho y 10mm de espesor.

9. Trancas de segurança em aço inox EN 1.4301 / Security dead bolt made in stainless steel EN 1.4301 / Pestillos de seguridad en acero inox EN 1.4301.

10. Chapa testa 2,5mm de espessura / Strike plate with 2,5mm thickness / Cerradero con 2,5mm espesor.

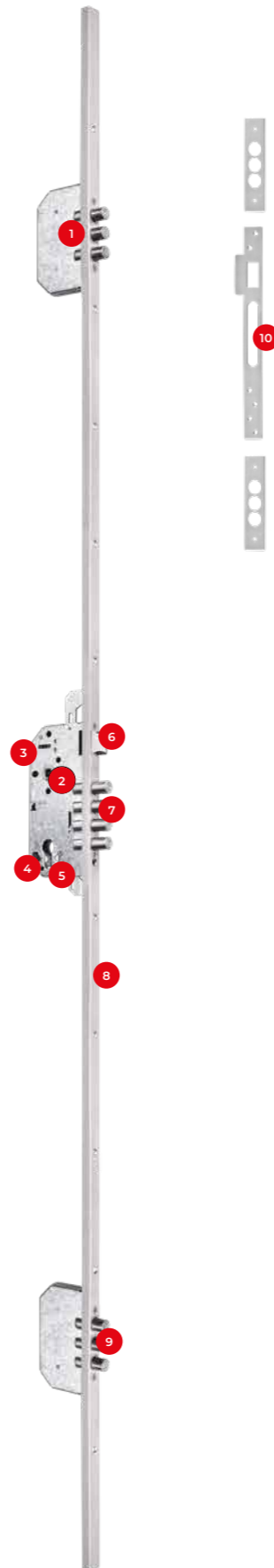

High security lock 3 Points - Stainless steel

IN.20.003 / Un.

Fechadura de embutir de alta segurança /
High security mortise lock /
Cerradura de emputrar de alta seguridad.

EN 1.4301 - AISI 304
Satinado / Satin



EN12209 **3 H5 0 0 C 7 B C 3 0**

IN.20.003.A (80mm) / Un.

Extensão para frente de fechadura de 80mm /
80mm Extension for the lock front /
Extensión para frente del cerradura 80mm.



IN.20.003.B (150mm) / Un.

Extensão para frente de fechadura de 150mm /
150mm Extension for the lock front /
Extensión para frente del cerradura 150mm.

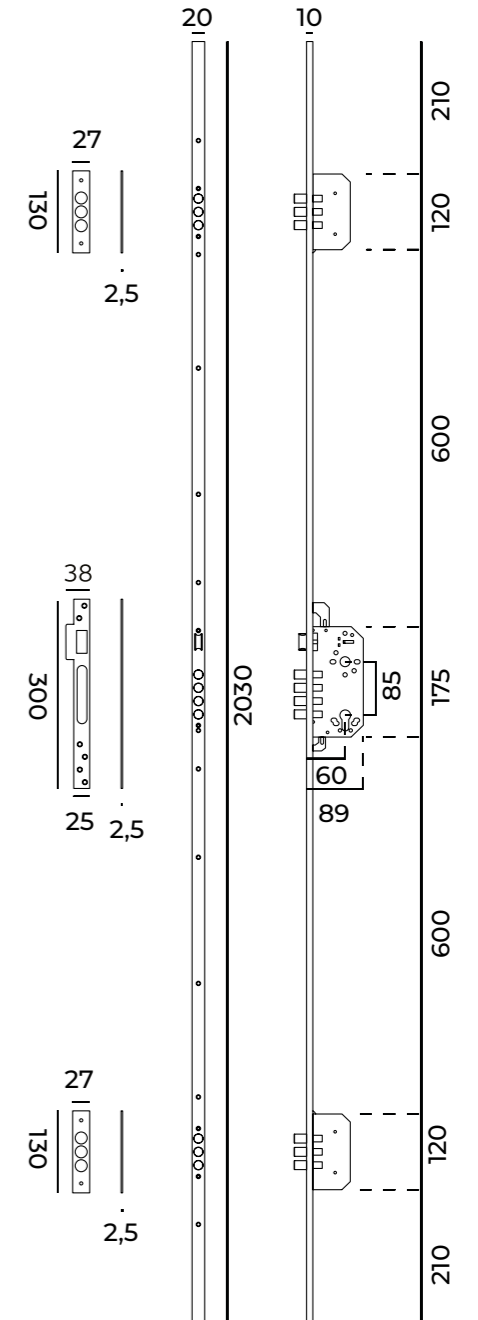

HIGH SECURITY

Fechadura de três pontos com escudete de segurança. A série de segurança foi criada para ser utilizada em portas que estão sujeitas a uma utilização elevada /

Three points lock with security protection rose. The security lock series was designed to be used on doors that are subject to high usage /

Cerradura de tres puntos con escudo de alta seguridad. La serie de cerraduras de seguridad fue creada para ser aplicada, en puertas que se utilizan de un modo elevado.

1. Trancas de segurança em aço inox EN 1.4301 / Security dead bolt made in stainless steel EN 1.4301 / Bullones de seguridad en acero inox EN 1.4301.

2. Quadra em aço inox com mola interior para eliminação da folga entre o puxador e a quadra / Stainless steel handle square hole with a internal spring to avoid any gap between the and the lock / Nueca en acero inox con muelle interior para eliminar la holgura entre la manilla e la nueca.

3. Furação para fixação do puxador / Handle fixing holes / Agujeros para tornillos pasantes.

4. Escudete ajustável de alta segurança para cilindro europeu. Sistema automático de ajuste à espessura da porta. Acabamento em PVD Titanium / Adjustable high security protection rose for european cylinder. Automatic adjust to the thickness of the door. PVD Titanium finish / Escudo ajustable de alta seguridad para bombillo. Con ajuste automatico al espesor de la puerta. PVD Titanium acabado.

5. Caixa fechada / Closed lock case / Caja cerrada.

6. Trinco reversível em aço inox EN 1.4301 / Adjustable latch made in stainless steel EN 1.4301 / Picaporte reversible en acero inox EN 1.4301.

7. Frente em inox lacado preto RAL 9005 20mm de largura e 10 mm de espessura / Front in stainless steel powder coated black RAL 9005 20mm wide and 10mm thick / Frente en acero inoxidable lacado en negro RAL 9005 sólo con 20mm de ancho y 10mm de espesor.

8. Chapa testa 2,5mm de espessura. Acabamento em PVD Titanium / Strike plate with 2,5mm thickness. PVD Titanium finish / Cerradero con 2,5mm espesor. PVD Titanium acabado.

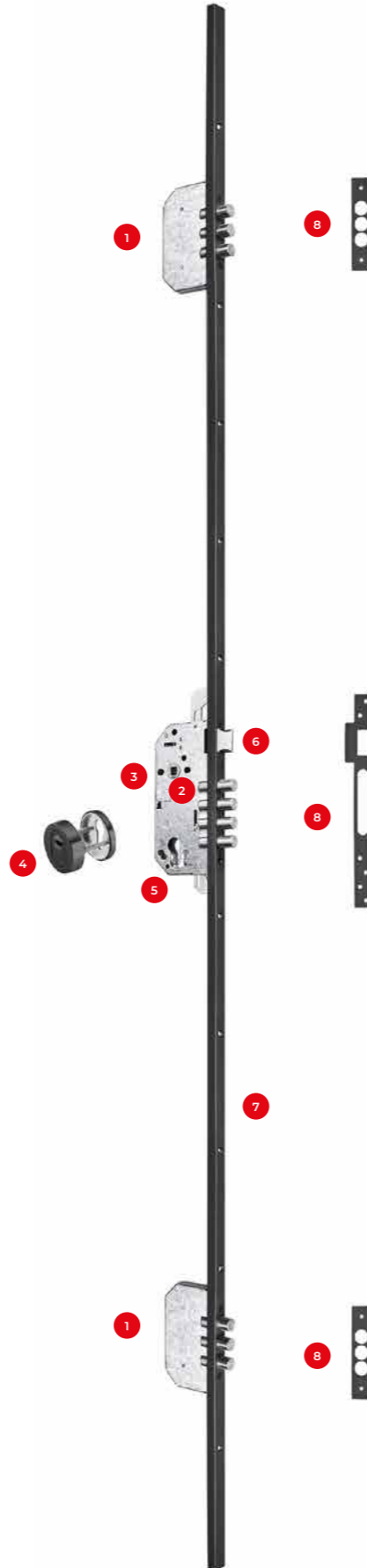

new

High security lock set 3 Points - Stainless steel

IN.20.003.KB / Un.

Fechadura de três pontos com escudete de segurança /
Three points lock with security protection rose /
Cerradura de tres puntos con escudo de alta seguridad.

EN 1.4301 - AISI 304
Preto / Black / Negro

EN12209 **3 H500C7B C30**



1 Un. 10 Un

IN.04.29S

Escudete ajustável de alta segurança para cilindro europeu. Sistema automático de ajuste à espessura da porta.

Adjustable high security protection rose for european cylinder. Automatic adjust to the thickness of the door. Escudo ajustable de alta seguridad para cilindro. Con ajuste automatico al espesor de la puerta.

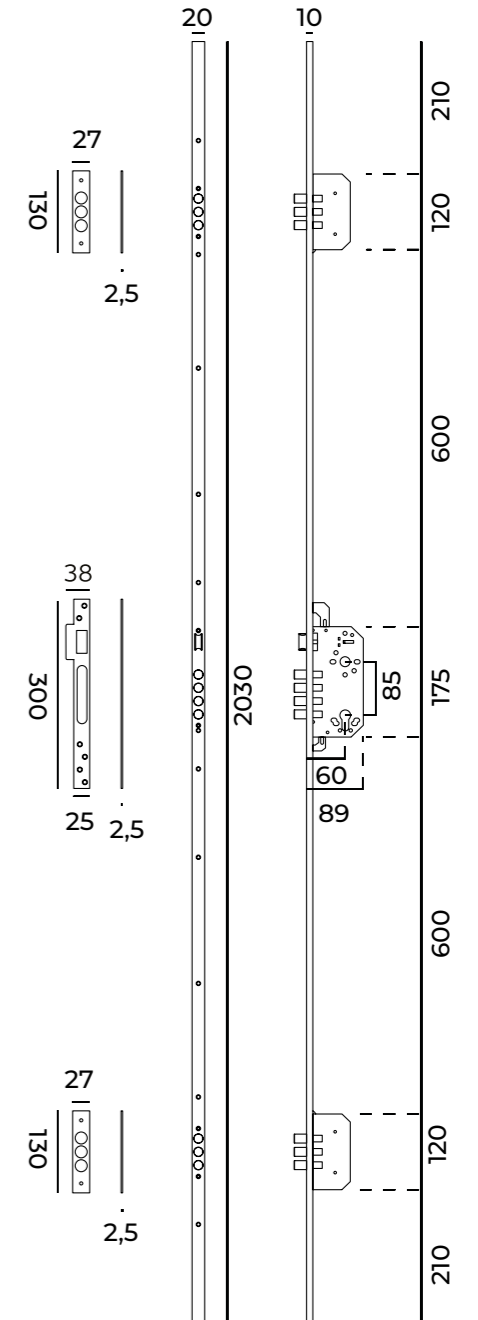
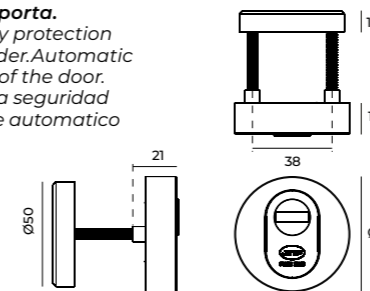

SECURITY RIM LOCK

RAL 7011 + COLORS

SEGURANÇA COM DESIGN

Fechadura de segurança para cilindro Europeu de sobrepor para portas de madeira ou metálicas /

SECURITY WITH DESIGN

Euro cylinder security rim lock for wooden or metallic doors /

SEGURIDAD CON DESIGN

Cerradura de seguridad para cilindro Europeo de sobreponer para puertas de madera o metálicas.

A fechadura clássica de sobrepor para porta de entrada foi redesenhada pela JNF, obtendo-se um elemento com muita presença mas com um design actual e equilibrado. É uma peça fundamental na segurança de uma porta, onde adicionamos versatilidade no acabamento e no grau de protecção.

O cilindro pode ser desde um modelo básico até elevada segurança incluindo cilindros eletrónicos com abertura por cartão. A instalação de um escudo temperado protector de cilindro à prova de brocagem confere-lhe uma enorme resistência contra ataques ao cilindro.

A caixa da fechadura é muito robusta, resulta numa peça única estampada em aço. Ocultamos os parafusos de fixação, resultando numa instalação muito mais discreta. Damos a possibilidade de decorar a fechadura de acordo com as restantes ferragens instaladas: cinza antracite como standard, aço escovado, aço negro mate, aço dourado mate, cor cobre e cor chocolate como opções.

Uma porta de entrada tradicional pode ser valorizada esteticamente com a instalação desta fechadura. A memória de uma porta antiga não é alterada por este elemento valorizador e permite actualizar a sua funcionalidade em segurança, técnica e design.

Todos os detalhes foram cuidados, desde as formas arredondadas das arestas, à eliminação de parafusos de fixação visíveis até aos elementos de fecho ao solo, onde é colocado um "copo" anti-sujidade. Os escudos de segurança são fornecidos com o mesmo acabamento da fechadura, conseguindo-se um resultado surpreendente no resultado final, onde a estética e a segurança ficaram a ganhar!

A JNF tem uma das coleções mais versáteis de cilindros para complementar a comodidade do uso desta fechadura: portas com chaves iguais, mestragem de porta de entrada, chave com múltiplas entradas incluindo por exemplo a porta do correio, a porta da garagem, etc.

1. Trancas de segurança em aço temperado;
2. Caixa em aço com 2mm de espessura;
3. Copo para pavimento com cobertura;
4. Trancas verticais para portas até 2,50m;
5. A protecção do cilindro aumenta o nível de segurança, permite a instalação do lado externo de um escudete de segurança. Maior segurança contra tentativas de arrombamento do cilindro. Escudete de segurança é vendido separadamente.
6. Tampas personalizadas com diferentes cores e acabamentos. Lacado em branco e cinza. Acabamento pvd titanium black, gold, copper e chocolate;
7. Remate superior com ajuste para reduzir folgas;

EN12209 **3 H5 0 0 B 7 B C 0 0**

Classificação aplicável com o escudete de segurança para cilindro IN.04.505
Classification applicable with Security european cylinder protection IN.04.505
Clasificación aplicable con la protección europea de seguridad para cilindros IN.04.505

The classic rim lock for the entrance door was redesigned by JNF, obtaining an element with a lot of presence but with a current and balanced design. It is a fundamental piece in the security of a door, where we add versatility in the finish and in the degree of protection.

The cylinder can be from a basic model to high security including electronic cylinders with card opening. The installation of a drill-proof cylinder protective tempered shield gives it enormous resistance against cylinder attacks.

The lock box is very robust, resulting from a single piece stamped in steel. We've hidden the fixing screws, resulting in a much more discreet installation. We offer the possibility to decorate the lock according to the other hardware installed: anthracite gray as standard, brushed steel, matt black steel, matt golden steel, copper color and chocolate color as options.

A traditional entrance door can be aesthetically enhanced with the installation of this lock. The memory of an old door is not altered by this valuing element and allows to update its functionality in terms of safety, technique and design.

Every detail has been taken care of, from the rounded shapes of the edges, to the elimination of visible fixing screws, to the closing elements to the floor, where an anti-dirt "cup" is placed. The security shields are supplied with the same finish as the lock, achieving a surprising result in the final result, where aesthetics and security won!

JNF has one of the most versatile collections of cylinders to complement the convenience of using this lock: doors with the same keys, entrance door master, key with multiple entries including, for example, the mail door, the garage door, etc.

1. Security dead bolt made in tempered steel
2. Steel box with 2mm thickness /
3. Bottom cup with dust proof cover
4. Vertical lock bars for doors up to 2,50m
5. Cylinder protection increases the level of security, allows the installation of a safety escutcheon on the outside. Greater security against attempts to break the cylinder. Security escutcheon is sold separately.
6. Stainless steel custom covers with different colors and finishes. Powder coating with colors available in white and gray. Pvd titanium finish in black, gold, copper and chocolate
7. Upper latch with adjustment to reduce the gaps

La clásica cerradura de seguridad para puerta de entrada fue rediseñada por JNF, consiguiendo un elemento con mucha presencia pero con un diseño actual y equilibrado. Es una pieza fundamental en la seguridad de una puerta, donde sumamos versatilidad en el acabado y en el grado de protección.

El cilindro puede ser desde un modelo básico hasta de alta seguridad incluyendo cilindros electrónicos con apertura de tarjeta. La instalación de un escudo templado de protección del cilindro antitaladro le confiere una enorme resistencia contra los ataques del cilindro.

La caja de seguridad es muy robusta, resultando de una sola pieza estampada en acero. Hemos ocultado los tornillos de fijación, dando como resultado una instalación mucho más discreta. Ofrecemos la posibilidad de decorar la cerradura según el resto de herrajes instalados: gris antracita de serie, acero cepillado, acero negro mate, acero dorado mate, color cobre y color chocolate como opciones.

Una puerta de entrada tradicional puede mejorar estéticamente con la instalación de esta cerradura. La memoria de una puerta antigua no se ve alterada por este elemento valorizador y permite actualizar su funcionalidad en cuanto a seguridad, técnica y diseño.

Se ha cuidado hasta el último detalle, desde las formas redondeadas de los cantos, pasando por la eliminación de los tornillos de fijación visibles, hasta los elementos de cierre al suelo, donde se coloca una "copa" antisujiedad. Los escudos de seguridad se suministran con el mismo acabado que la cerradura, consiguiendo un resultado sorprendente en el resultado final, donde ganó la estética y la seguridad!

JNF dispone de una de las colecciones de cilindros más versátiles para complementar la comodidad de utilizar esta cerradura: puertas con llaves iguales, puerta maestra de entrada, llave con múltiples entradas incluyendo, por ejemplo, la puerta del correo, la puerta del garaje, etc.

1. Cierres de seguridad de acero endurecido
2. Caja de acero de 2mm de espesor.
3. Receptor de suelo con tapa.
4. Varillas verticales para puertas de hasta 2,50m.
5. La protección del cilindro aumenta el nivel de seguridad, permite la instalación de un escudo de seguridad en el exterior. Mayor seguridad ante intentos de rotura del cilindro. El escudo de seguridad se vende por separado.
6. Tapas personalizadas en diferentes colores y acabados. Lacado en blanco y gris. Acabado pvd negro titanio, dorado, cobre y chocolate
7. Remate superior con ajuste para reducir las holguras.

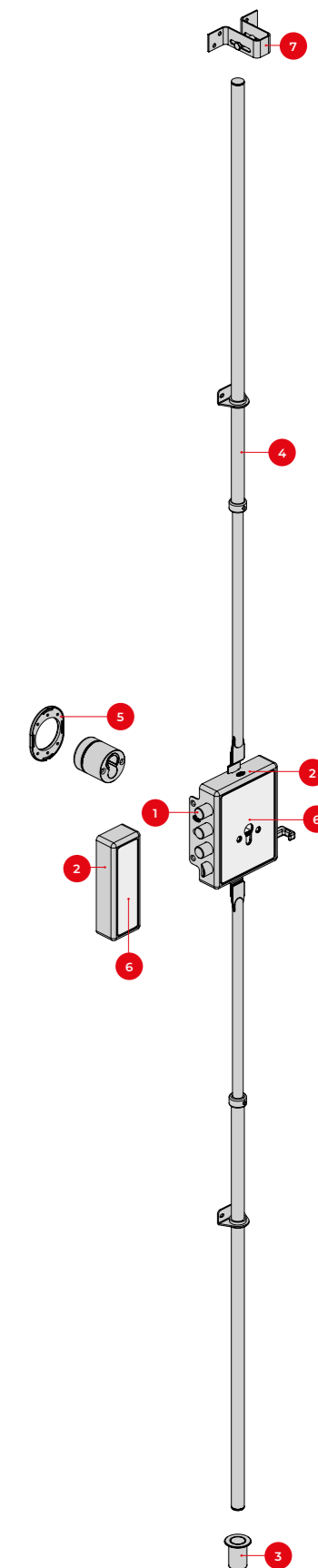

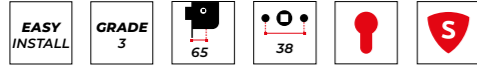

Security rim lock RAL 7011

IN.20.050.D / Set
(Direita/ Right/ Derecha)
IN.20.050.E / Set
(Esquerda/ Left/ Izquierda)

Fechadura de segurança de sobrepor para cilindro europeu para portas de madeira ou metálicas / Security rim lock for european cylinder for wood or metallic doors / Cerradura de seguridad para cilindro europeo para puertas de madera o metal

Aço / Steel / Acero
RAL 7011 (cinza antracite / anthracite gray / gris antracita)

IN.04.050.S / Set

Escudete de segurança para cilindro europeu em aço temperado / Security european cylinder protection made in hardened steel / Escudo de seguridad para cilindro europeo de acero endurecido.

Aço / Steel / Acero
RAL 7011 (cinza antracite / anthracite gray / gris antracita)



Security rim lock RAL 7011 + 9016

IN.20.050.D / Set
IN.20.050.E / Set

Fechadura de segurança de sobrepor para cilindro europeu para portas de madeira ou metálicas / Security rim lock for european cylinder for wood or metallic doors / Cerradura de seguridad para cilindro europeo para puertas de madera o metal

Aço / Steel / Acero
RAL 7011 (cinza antracite / anthracite gray / gris antracita)

IN.20.050.T.D.W / Set
(Direita/ Right/ Derecha)
IN.20.050.T.E.W / Set
(Esquerda/ Left/ Izquierda)

Set de tampas em aço termolacado RAL 9016 com adesivo / Set of covers made in steel powder coated RAL 9016 with adhesive / Juego de cubiertas de acero termolacado RAL 9016 con adhesivo

Aço / Steel / Acero
RAL 9016 (branco mate / white matte / blanco mate)

IN.04.050.S / Set
Escudete de segurança para cilindro em aço temperado / Security european cylinder protection made in hardened steel / Escudo de seguridad para cilindro europeo de acero endurecido.

Aço / Steel / Acero
RAL 7011 (cinza antracite / anthracite gray / gris antracita)

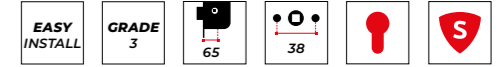

Security rim lock RAL 7011 + Black

IN.20.050.D / Set
IN.20.050.E / Set

Fechadura de segurança de sobrepor para cilindro europeu para portas de madeira ou metálicas / Security rim lock for european cylinder for wood or metallic doors / Cerradura de seguridad para cilindro europeo para puertas de madera o metal

Aço / Steel / Acero
RAL 7011 (cinza antracite / anthracite gray / gris antracita)

IN.20.050.T.D.TB / Set
(Direita/ Right/ Derecha)
IN.20.050.T.E.TB / Set
(Esquerda/ Left/ Izquierda)

Set de tampas em aço inoxidável em TITANIUM Black com adesivo / Set of covers made in stainless steel TITANIUM Black with adhesive / Juego de cubiertas de acero inoxidable con TITANIUM Black con adhesivo.

Aço inoxidável / Stainless steel / Acero inoxidable
+ PVD TITANIUM Black

IN.04.050.S.TB / Set
Escudete de segurança para cilindro em aço temperado / Security european cylinder protection made in hardened steel / Escudo de seguridad para cilindro europeo de acero endurecido.

Aço / Steel / Acero
RAL 7011 (cinza antracite / anthracite gray / gris antracita)
+ PVD TITANIUM Black



Security rim lock RAL 7011 + Gold

IN.20.050.D / Set
IN.20.050.E / Set

Fechadura de segurança de sobrepor para cilindro europeu para portas de madeira ou metálicas / Security rim lock for european cylinder for wood or metallic doors / Cerradura de seguridad para cilindro europeo para puertas de madera o metal

Aço / Steel / Acero
RAL 7011 (cinza antracite / anthracite gray / gris antracita)

IN.20.050.T.D.TG / Set
(Direita/ Right/ Derecha)
IN.20.050.T.E.TG / Set
(Esquerda/ Left/ Izquierda)

Set de tampas em aço inoxidável em TITANIUM Gold com adesivo / Set of covers made in stainless steel TITANIUM Gold with adhesive / Juego de cubiertas de acero inoxidable con TITANIUM Gold con adhesivo.

Aço inoxidável / Stainless steel / Acero inoxidable
+ PVD TITANIUM Gold

IN.04.050.S.TG / Set
Escudete de segurança para cilindro em aço temperado / Security european cylinder protection made in hardened steel / Escudo de seguridad para cilindro europeo de acero endurecido.

Aço / Steel / Acero
RAL 7011 (cinza antracite / anthracite gray / gris antracita)
+ PVD TITANIUM Gold

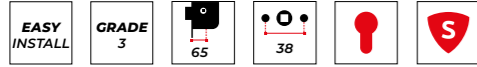

Security rim lock RAL 7011 + Copper

IN.20.050.D / Set
IN.20.050.E / Set
Fechadura de segurança de sobrepor para cilindro europeu para portas de madeira ou metálicas / Security rim lock for european cylinder for wood or metallic doors / Cerradura de seguridad para cilindro europeo para puertas de madera o metal
Aço / Steel / Acero
RAL 7011 (cinza antracite / anthracite gray / gris antracita)



IN.20.050.T.D.TCO / Set
(Direita / Right / Derecha)
IN.20.050.T.E.TCO / Set
(Esquerda / Left / Izquierda)
Set de tampas em aço inoxidável em TITANIUM Copper com adesivo / Set of covers made in stainless steel TITANIUM Copper with adhesive / Juego de cubiertas de acero inoxidable con TITANIUM Copper con adhesivo.
Aço inoxidável / Stainless steel / Acero inoxidable
+ PVD TITANIUM Copper



IN.04.050.S.TCO / Set
Escudete de segurança para cilindro em aço temperado / Security european cylinder protection made in hardened steel / Escudo de seguridad para cilindro europeo de acero endurecido.
Aço / Steel / Acero
RAL 7011 (cinza antracite / anthracite gray / gris antracita)
+ PVD TITANIUM Copper



Security rim lock RAL 7011 + Chocolate

IN.20.050.D / Set
IN.20.050.E / Set
Fechadura de segurança de sobrepor para cilindro europeu para portas de madeira ou metálicas / Security rim lock for european cylinder for wood or metallic doors / Cerradura de seguridad para cilindro europeo para puertas de madera o metal
Aço / Steel / Acero
RAL 7011 (cinza antracite / anthracite gray / gris antracita)



IN.20.050.T.D.TCH / Set
(Direita / Right / Derecha)
IN.20.050.T.E.TCH / Set
(Esquerda / Left / Izquierda)
Set de tampas em aço inoxidável em TITANIUM Black com adesivo / Set of covers made in stainless steel TITANIUM Black with adhesive / Juego de cubiertas de acero inoxidable con TITANIUM Black con adhesivo.
Aço inoxidável / Stainless steel / Acero inoxidable
+ PVD TITANIUM Chocolate



IN.04.050.S.TCH / Set
Escudete de segurança para cilindro em aço temperado / Security european cylinder protection made in hardened steel / Escudo de seguridad para cilindro europeo de acero endurecido.
Aço / Steel / Acero
RAL 7011 (cinza antracite / anthracite gray / gris antracita)
+ PVD TITANIUM Chocolate

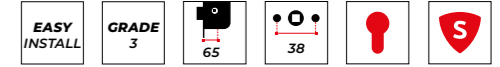

Security rim lock RAL 7011 + Satin

IN.20.050.D / Set
IN.20.050.E / Set
Fechadura de segurança de sobrepor para cilindro europeu para portas de madeira ou metálicas / Security rim lock for european cylinder for wood or metallic doors / Cerradura de seguridad para cilindro europeo para puertas de madera o metal
Aço / Steel / Acero
RAL 7011 (cinza antracite / anthracite gray / gris antracita)



IN.20.050.T.D.I / Set
(Direita / Right / Derecha)
IN.20.050.T.E.I / Set
(Esquerda / Left / Izquierda)
Set de tampas em aço inoxidável com adesivo / Set of covers made in stainless steel with adhesive / Juego de cubiertas de acero inoxidable con con adhesivo.



Aço inoxidável /
Stainless steel / Acero inoxidable

IN.04.050.S.I / Set
Escudete de segurança para cilindro em aço temperado / Security european cylinder protection made in hardened steel / Escudo de seguridad para cilindro europeo de acero endurecido.
Aço / Steel / Acero
RAL 7011 (cinza antracite / anthracite gray / gris antracita)
+ INOX

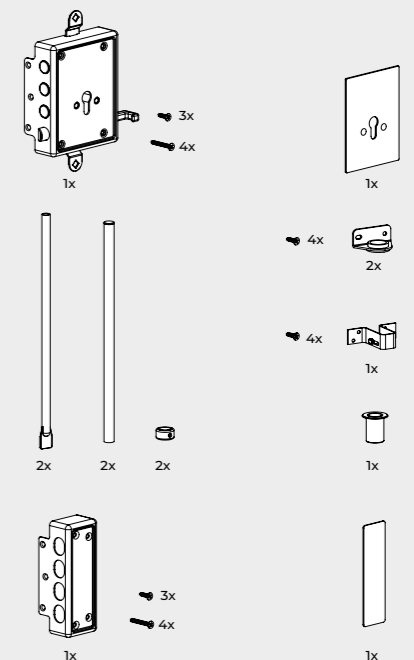
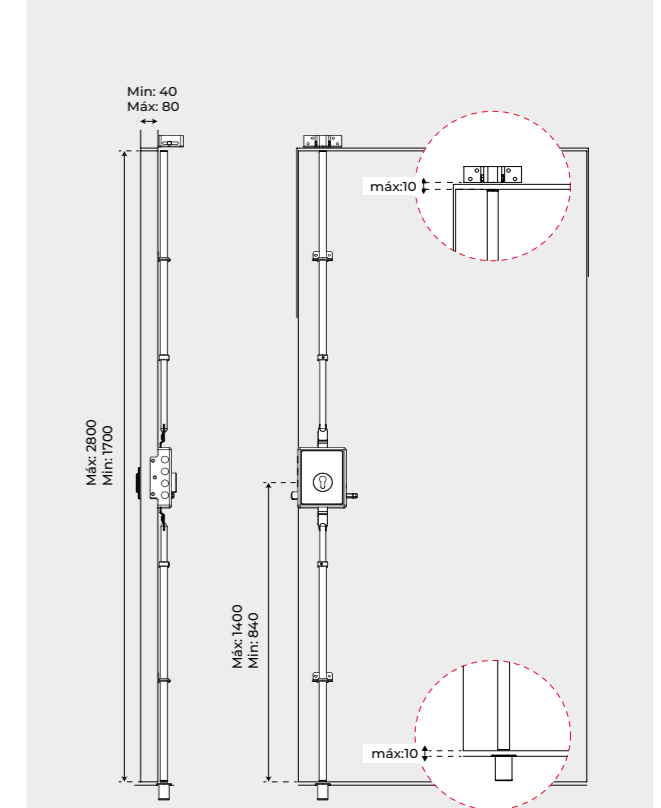

SECURITY PROTECTION

RAL 7011 + COLORS

O escudete de segurança é reforçado no lado exterior, para dar maior segurança ao cilindro. Com fixações invisíveis, através de parafusos passantes ocultos, garante uma maior resistência contra extrações forçadas. As suas arestas arredondadas dificultam o arrombamento por torção mecânica.

The security escutcheon is reinforced on the outer side to provide extra protection for the cylinder. With hidden fixings, through hidden through bolts, it ensures greater resistance against pulling. Its rounded edges make it difficult to grip.

El escudo de seguridad está reforzado en el exterior para proporcionar mayor seguridad al cilindro. Las fijaciones invisibles con pernos pasantes ocultos garantizan una mayor resistencia contra la extracción forzada. Sus bordes redondeados dificultan su rotura por torsión mecánica.



Security protection Eurocylinder

IN.04.50S / Set

Escudete de segurança para cilindro europeu em aço temperado / Security european cylinder protection made in hardened steel / Escudo de seguridad para cilindro europeo de acero endurecido.



Aço / Steel / Acero

RAL 7011 (cinza antracite / anthracite gray / gris antracita)

IN.04.50S.TB / Set

Escudete de segurança para cilindro europeu em aço temperado / Security european cylinder protection made in hardened steel / Escudo de seguridad para cilindro europeo de acero endurecido.



Aço / Steel / Acero

RAL 7011 (cinza antracite / anthracite gray / gris antracita) + PVD TITANIUM Black



IN.04.50S.TG / Set

Escudete de segurança para cilindro europeu em aço temperado / Security european cylinder protection made in hardened steel / Escudo de seguridad para cilindro europeo de acero endurecido.



Aço / Steel / Acero

RAL 7011 (cinza antracite / anthracite gray / gris antracita) + PVD TITANIUM Gold

X		
40	60/30	-
50	70/30	5
60	80/30	10
70	90/30	15
80	100/30	20

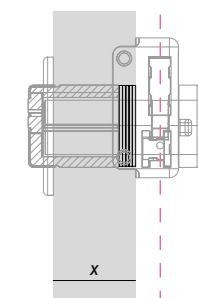

IN.04.50S.TCO / Set

Escudete de segurança para cilindro europeu em aço temperado / Security european cylinder protection made in hardened steel / Escudo de seguridad para cilindro europeo de acero endurecido.



Aço / Steel / Acero

RAL 7011 (cinza antracite / anthracite gray / gris antracita) + PVD TITANIUM Copper

IN.04.50S.TCH / Set

Escudete de segurança para cilindro europeu em aço temperado / Security european cylinder protection made in hardened steel / Escudo de seguridad para cilindro europeo de acero endurecido.



Aço / Steel / Acero

RAL 7011 (cinza antracite / anthracite gray / gris antracita) + PVD TITANIUM Chocolate

IN.04.50S.I / Set

Escudete de segurança para cilindro europeu em aço temperado / Security european cylinder protection made in hardened steel / Escudo de seguridad para cilindro europeo de acero endurecido.



Aço / Steel / Acero

RAL 7011 (cinza antracite / anthracite gray / gris antracita) + INOX

RIM LOCK

DESIGN E ROBUSTEZ

NUMA FECHADURA
TRADICIONAL DE FÁCIL
INSTALAÇÃO

DESIGN AND STURDINESS

IN A TRADITIONAL RIM
LOCK EASY TO INSTALL

DISEÑO Y ROBUSTEZ

EN UNA CERRADURA
TRADICIONAL FÁCIL
DE INSTALAR



1 - IN.20.051.T.W
2 - IN.20.051.T.TB
3 - IN.20.051.T.TCO
4 - IN.20.051.T.TCH
5 - IN.20.051.T.TC
6 - IN.20.051.T.I

A antiga e tradicional fechadura de sobrepor foi redesenhada pela JNF, resultou uma peça robusta com design actual e muito versátil. Substituímos o habitual cilindro redondo e fixo das fechaduras existentes por um cilindro de perfil europeu que pode ser substituído a qualquer momento.

O cilindro pode ser desde um modelo básico até elevada segurança incluindo cilindros eletrónicos com abertura por cartão. Possibilita a instalação dum escudo protector de cilindro, que lhe confere grande robustez contra ataques ao cilindro. A caixa da fechadura é muito robusta, resulta duma peça única estampada em aço.

Ocultamos os parafusos de fixação, resultando numa instalação muito mais discreta. Damos a possibilidade de decorar a fechadura de acordo com as restantes ferragens instaladas: cinza antracite como standard, aço escovado, dourado, cor cobre e cor chocolate como opções.

Uma porta tradicional pode ser valorizada pela instalação desta fechadura que respeita a estética e memória duma porta, permitindo actualizar a sua funcionalidade em segurança, técnica e design.

The old and traditional rim lock was redesigned by JNF, resulting in a robust piece with a current and very versatile design. We replaced the usual fixed round cylinder of existing locks with a European profile cylinder that can be replaced at any time.

The cylinder can be from a basic model to high security including electronic cylinders with card opening. It allows the installation of a cylinder protection escutcheon which gives it great strength against cylinder attacks. The lock box is very robust, resulting from a single piece stamped in steel.

We've hidden the fixing screws, resulting in a much more discreet installation. We offer the possibility to decorate the lock according to the other hardware installed: anthracite gray as standard, brushed steel, gold, copper color and chocolate color as options.

A traditional door can be enhanced by installing this lock that respects the aesthetics and memory of a door, allowing its functionality to be updated in terms of security, technique and design.

La antigua y tradicional cerradura de sobreponer fue rediseñada por JNF, dando como resultado una pieza robusta con un diseño actual y muy versátil. Hemos sustituido el cilindro redondo fijo habitual de las cerraduras existentes por un cilindro de perfil europeo que se puede sustituir en cualquier momento.

El cilindro puede ser desde un modelo básico hasta de alta seguridad incluyendo cilindros electrónicos con apertura de tarjeta. Permite la instalación de un escudo protector del cilindro, lo que le confiere una gran robustez frente a ataques al cilindro. La caja de seguridad es muy robusta, resultando de una sola pieza estampada en acero.

Hemos ocultado los tornillos de fijación, dando como resultado una instalación mucho más discreta. Ofrecemos la posibilidad de decorar la cerradura según el resto de herrajes instalados: gris antracita de serie, acero cepillado, dorado, color cobre y color chocolate como opciones.

Una puerta tradicional puede valorizarse instalando esta cerradura que respeta la estética y la memoria de una puerta, permitiendo actualizar su funcionalidad en cuanto a seguridad, técnica y diseño.

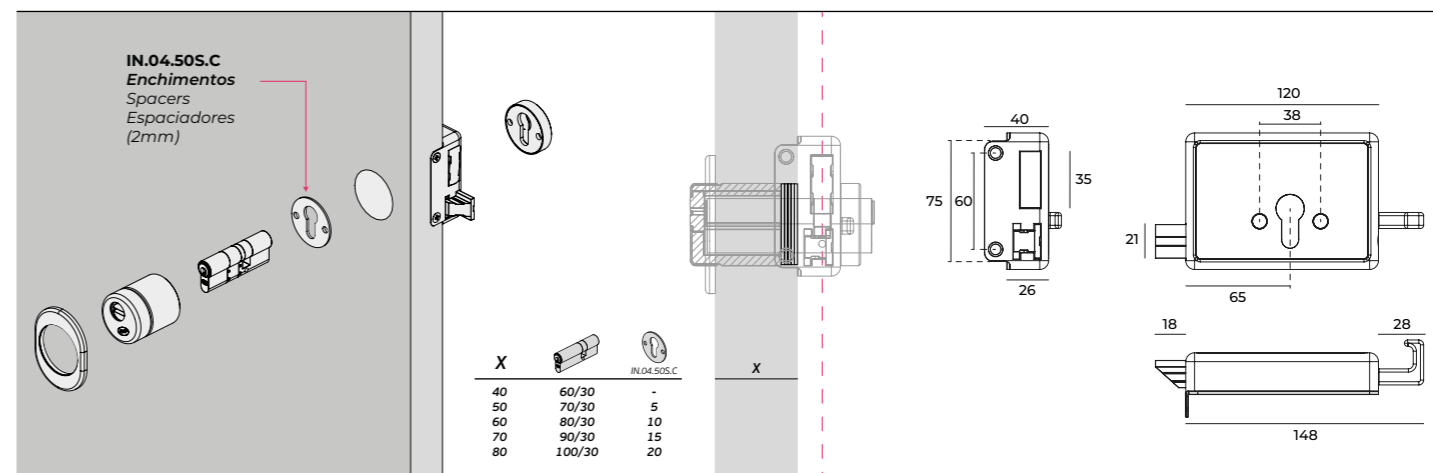

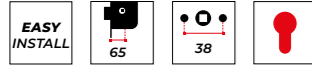

Rim lock Eurocylinder RAL 7011

IN.20.051.D / Set
(Direita/ Right / Derecha)
IN.20.051.E / Set
(Esquerda / Left / Izquierda)



Fechadura de sobrepor para cilindro europeu para portas de madeira ou metálicas / Rim lock for european cylinder for wood or metallic doors / Cerradura para cilindro europeo para puertas de madera o metal.

Aço / Steel / Acero
RAL 7011 (cinza antracite / anthracite gray / gris antracita)



Rim lock Eurocylinder RAL 7011 + 9016

IN.20.051.D / Set
(Direita/ Right / Derecha)
IN.20.051.E / Set
(Esquerda / Left / Izquierda)



Fechadura de sobrepor para cilindro europeu para portas de madeira ou metálicas / Rim lock for european cylinder for wood or metallic doors / Cerradura para cilindro europeo para puertas de madera o metal.

Aço / Steel / Acero
RAL 7011 (cinza antracite / anthracite gray / gris antracita)

IN.20.051.T.D.W / Set
(Direita/ Right / Derecha)
IN.20.051.T.E.W / Set
(Esquerda / Left / Izquierda)



Tampa em aço em termolacado RAL 9016 com adesivo / Cover made in steel with powder coated RAL 9016 with adhesive / Cubierta de acero em termolacado RAL 9016 con adhesivo.

Aço / Steel / Acero
RAL 9016 (branco mate / white matte / blanco mate)

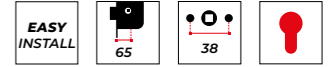

Rim lock Eurocylinder RAL 7011 + Black

IN.20.051.D / Set
(Direita/ Right / Derecha)
IN.20.051.E / Set
(Esquerda / Left / Izquierda)



Fechadura de sobrepor para cilindro europeu para portas de madeira ou metálicas / Rim lock for european cylinder for wood or metallic doors / Cerradura para cilindro europeo para puertas de madera o metal.

Aço / Steel / Acero
RAL 7011 (cinza antracite / anthracite gray / gris antracita)

IN.20.051.T.D.TB / Set
(Direita/ Right / Derecha)
IN.20.051.T.E.TB / Set
(Esquerda / Left / Izquierda)



Tampa em aço inoxidável em TITANIUM Black com adesivo / Cover made in stainless steel TITANIUM Black with adhesive / Cubierta de acero inoxidable con TITANIUM Black con adhesivo.

Aço inoxidável / Stainless steel / Acero inoxidable
+ PVD TITANIUM Black



Rim lock Eurocylinder RAL 7011 + Gold

IN.20.051.D / Set
(Direita/ Right / Derecha)
IN.20.051.E / Set
(Esquerda / Left / Izquierda)



Fechadura de sobrepor para cilindro europeu para portas de madeira ou metálicas / Rim lock for european cylinder for wood or metallic doors / Cerradura para cilindro europeo para puertas de madera o metal.

Aço / Steel / Acero
RAL 7011 (cinza antracite / anthracite gray / gris antracita)

IN.20.051.T.D.TG / Set
(Direita/ Right / Derecha)
IN.20.051.T.E.TG / Set
(Esquerda / Left / Izquierda)



Tampa em aço inoxidável em TITANIUM Gold com adesivo / Cover made in stainless steel TITANIUM Gold with adhesive / Cubierta de acero inoxidable con TITANIUM Gold con adhesivo.

Aço inoxidável / Stainless steel / Acero inoxidable
+ PVD TITANIUM Gold

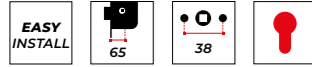

Rim lock Eurocylinder RAL 7011 + Copper

IN.20.051.D / Set
(Direita/ Right / Derecha)
IN.20.051.E / Set
(Esquerda / Left / Izquierda)



Fechadura de sobrepor para cilindro europeu para portas de madeira ou metálicas / Rim lock for european cylinder for wood or metallic doors / Cerradura para cilindro europeo para puertas de madera o metal.

Aço / Steel / Acero
RAL 7011 (cinza antracite / anthracite gray / gris antracita)

IN.20.051.T.D.TCO / Set
(Direita/ Right / Derecha)
IN.20.051.T.E.TCO / Set
(Esquerda / Left / Izquierda)



Tampa em aço inoxidável em TITANIUM Copper com adesivo / Cover made in stainless steel TITANIUM Copper with adhesive / Cubierta de acero inoxidable con TITANIUM Copper con adhesivo.

Aço inoxidável / Stainless steel / Acero inoxidable
+ PVD TITANIUM Copper



Rim lock Eurocylinder RAL 7011 + Chocolate

IN.20.051.D / Set
(Direita/ Right / Derecha)
IN.20.051.E / Set
(Esquerda / Left / Izquierda)



Fechadura de sobrepor para cilindro europeu para portas de madeira ou metálicas / Rim lock for european cylinder for wood or metallic doors / Cerradura para cilindro europeo para puertas de madera o metal.

Aço / Steel / Acero
RAL 7011 (cinza antracite / anthracite gray / gris antracita)

IN.20.051.T.D.TCH / Set
(Direita/ Right / Derecha)
IN.20.051.T.E.TCH / Set
(Esquerda / Left / Izquierda)



Tampa em aço inoxidável em TITANIUM Chocolate com adesivo / Cover made in stainless steel TITANIUM Chocolate with adhesive / Cubierta de acero inoxidable con TITANIUM Chocolate con adhesivo.

Aço inoxidável / Stainless steel / Acero inoxidable
+ PVD TITANIUM Chocolate



Rim lock Eurocylinder RAL 7011 + Satin

IN.20.051.D / Set
(Direita/ Right / Derecha)
IN.20.051.E / Set
(Esquerda / Left / Izquierda)



Fechadura de sobrepor para cilindro europeu para portas de madeira ou metálicas / Rim lock for european cylinder for wood or metallic doors / Cerradura para cilindro europeo para puertas de madera o metal.

Aço / Steel / Acero
RAL 7011 (cinza antracite / anthracite gray / gris antracita)

IN.20.051.T.D.I / Set
(Direita/ Right / Derecha)
IN.20.051.T.E.I / Set
(Esquerda / Left / Izquierda)



Tampa em aço inoxidável com adesivo / Cover made in stainless steel with adhesive / Cubierta de acero inoxidable con adhesivo.

Aço inoxidável /
Stainless steel / Acero inoxidable



IN.04.50S



IN.04.50S.TB



IN.04.50S.TG



IN.04.50S.TCO



IN.04.50S.TCH



IN.04.50S.I

MAGNETIC LOCKS

Fechaduras desenvolvidas para a indústria de portas, permitindo mecanizar todas as folhas com a mesma medida, a escolha da fechadura pode ser efectuada na obra. O sistema de trinco magnético permite um funcionamento silencioso e suave garantindo uma resistência e aspecto semelhante a uma fechadura tradicional.

Locks developed for the door industry. All the doors can be drilled with the same hole box. The lock can be chose at the building. The magnetic latch system allows a silent and smooth operation and at the same time ensures a similar look to a traditional lock.

Cerraduras desarrolladas para la industria de puertas. El cajeado es identico en todas las referencias. La cerradura puede ser elejida en obra. El sistema de cierre magnético permite un funcionamiento silencioso y suave garantizando un bueno funcionamiento y un aspecto similar a una cerradura tradicional.



1. Quadra 8x8 com limitação de curso /
8x8 spindle with path limitation /
Nueca 8x8 con limitación de curso.
2. Furação para fixação do puxador /
Handle fixing holes /
Agujeros para tornillos pasantes.
3. Caixa fechada /
Closed lock case /
Caja cerrada.
4. Frente com 18mm /
18mm front plate
Frontal con 18mm
5. Trinco magnético /
Magnetic latch /
Picaporte magnético.
6. Chapa testa reversível e ajustável /
Reversible and adjustable strike plate /
Cerradero reversible y adjustable.



Magnetic mortise locks

Satin niquel / Black Anthracite / Gray / Black



O mesmo entalhe na porta permite a aplicação de 3 modelos de fechaduras com funções diferentes. A maquinação da porta é simétrica, o que a torna reversível /
The same cut out in the door allows the application of 3 models of locks with different functions. The machining of the door is symmetrical, which makes it reversible /
La misma muesca en la puerta permite la aplicación de 3 modelos de cerraduras con diferentes funciones. El mecanizado de la puerta es simétrico, lo que la hace reversible.



Magnetic mortise lock

For european cylinder 60

IN.20.835.60 (SATIN NICKEL) / Un.
IN.20.835.60.BA (BLACK ANTHRACITE) / Un.
IN.20.835.60.G (GRAY - RAL 9006) / Un.
IN.20.835.60.B (BLACK - RAL 9005) / Un.

Fechadura de embutir magnética para cilindro Europeu /
Magnetic mortise door lock for European cylinder /
Cerradura de embutir magnética para cilindro Europeo.

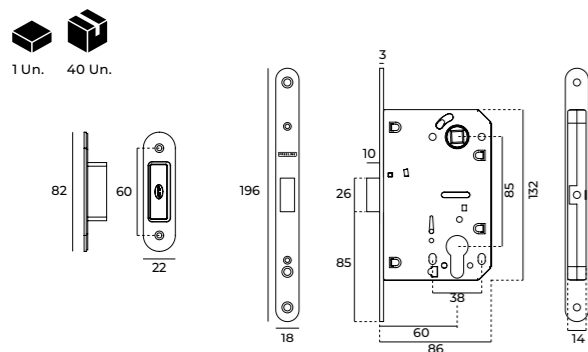

Magnetic mortise lock

For bathroom 60

IN.20.836.60 (SATIN NICKEL) / Un.
IN.20.836.60.BA (BLACK ANTHRACITE) / Un.
IN.20.836.60.G (GRAY - RAL 9006) / Un.
IN.20.836.60.B (BLACK - RAL 9005) / Un.

Fechadura de embutir magnética para casa de banho /
Magnetic mortise door lock for bathroom use /
Cerradura de embutir magnética para baño.

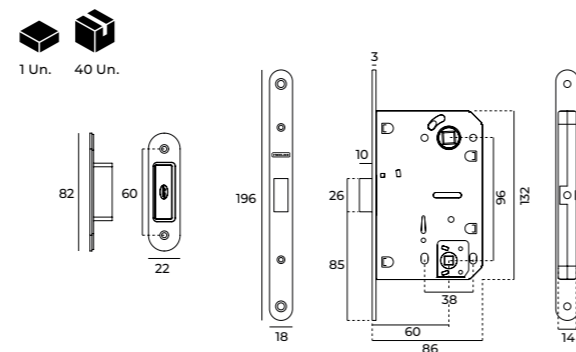

Magnetic mortise lock

With normal key 60

IN.20.837.60 (SATIN NICKEL) / Un.
IN.20.837.60.BA (BLACK ANTHRACITE) / Un.
IN.20.837.60.G (GRAY - RAL 9006) / Un.
IN.20.837.60.B (BLACK - RAL 9005) / Un.

Fechadura de embutir magnética com chave normal.
Chave com 6 combinações /
Magnetic mortise door lock with normal key.
Key with 6 combinations /
Cerradura de embutir magnética con llave.
Llave con 6 combinaciones.

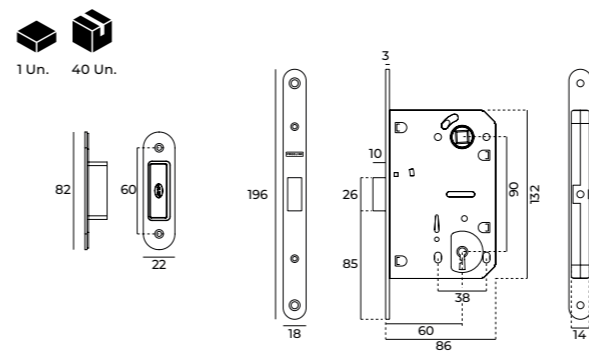

Chapa testa magnética reversível e ajustável
por posição. A folga do trinco em relação à
chapa testa é ajustável em +1mm / -1mm
pela rotação de 180° /

Magnetic strike plate, reversible and adjustable
by position. The gap of the strike plate to the
magnetic bolt is adjustable in +1mm / -1mm
by the rotation of 180° /

Cerradero magnético reversible y ajustable por
posición. La holgura del picaporte relativo con
lo cerradero eres ajustable en +1mm / -1mm
por la rotación de 180°.

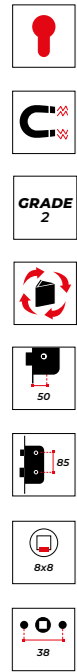

Magnetic mortise lock

For european cylinder 50

IN.20.835.50 (SATIN NICKEL) / Un.
IN.20.835.50.BA (BLACK ANTHRACITE) / Un.

Fechadura de embutir magnética para cilindro Europeu /
Magnetic mortise door lock for European cylinder /
Cerradura de embutir magnetica para cilindro Europeo.

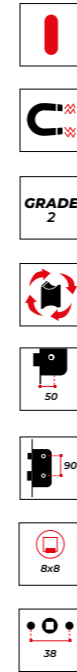
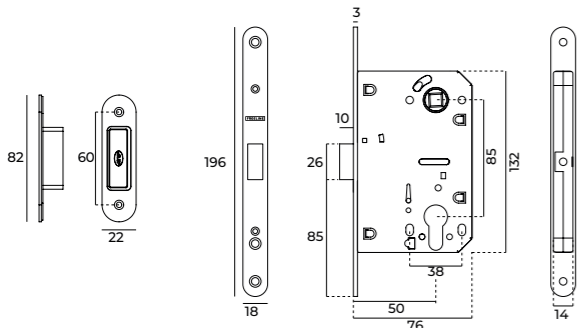

Magnetic mortise lock

With normal key 50

IN.20.837.50 (SATIN NICKEL) / Un.
IN.20.837.50.BA (BLACK ANTHRACITE) / Un.

Fechadura de embutir magnética com chave normal.
Chave com 6 combinações /
Magnetic mortise door lock with normal key.
Key with 6 combinations /
Cerradura de embutir magnetica con llave.
Llave con 6 combinaciones.

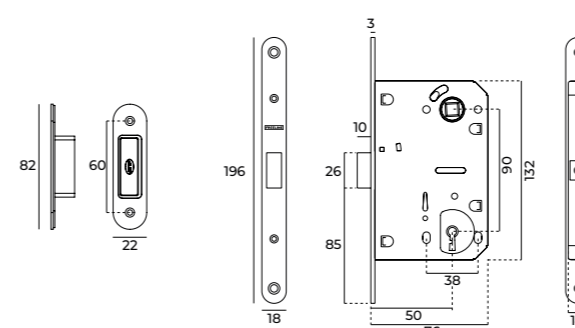

Chapa testa magnética reversível e ajustável
por posição. A folga do trinco em relação à
chapa testa é ajustável em +1mm / -1mm
pela rotação de 180° /

Magnetic strike plate, reversible and adjustable
by position. The gap of the strike plate to the
magnetic bolt is adjustable in +1mm / -1mm by
the rotation of 180° /

Cerradero magnético reversible y ajustable por
posición. La holgura del picaporte relativo con
lo cerradero eres ajustable en +1mm / -1mm
por la rotación de 180°.

790 Series

A série 790 foi desenvolvida com o objetivo de criar uma fechadura competitiva, com distância entre eixos de 85mm, mantendo a classe 3 /
790 series was developed with the aim of creating a competitive lock with distance between centers of 85mm keeping the class 3 /
La serie 790 fue desarrollado con el objetivo de crear una cerradura competitiva, con distancia entre ejes de 85mm, manteniendo la clase 3.



1.Furação para fixação do puxador / Handle fixing holes / Agujeros para tornillos pasantes.

5.Língua em aço inox EN 1.4301/ Dead bolt made in stainless steel EN 1.4301 / Pestillo en acero inox EN 1.4301.

2.Preparada para cilindro europeu / Ready for european cylinder / Preparada para cilindro europeu.

6.Frente em aço Inox EN 1.4301 / Front plate made in stainless steel EN 1.4301 / Frente en acero inoxidable EN 1.4301.

3.Caixa fechada/ Closed lock case / Caja cerrada.

7.Chapa testa reversível / Reversible strike plate / Cerradero reversible.

4.Trinco reversível em liga de zinco / Reversible latch made in zinc alloy / Picaporte reversible en aleación de zinc.

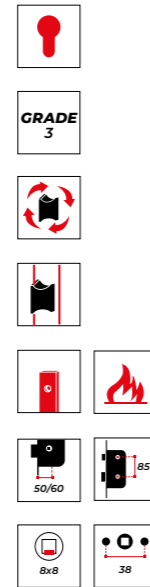

Mortise lock square Eurocylinder 60 / 50 - 85

IN.20.792.60 / Un.
IN.20.792.50 / Un.

Fechadura de embutir com cantos retos para cilindro europeu. Indicada para portas com uso elevado /
Mortise door lock with square corners for european cylinder. Recommended for doors with heavy use /
Cerradura de embutir con esquinas cuadradas para cilindro europeo. Indicada para puertas con uso elevado.

EN 1.4301 - AISI 304
Satinado / Satin

FIRE TEST EVIDENCE
EN12209 **3**H5110B3B|A3|0

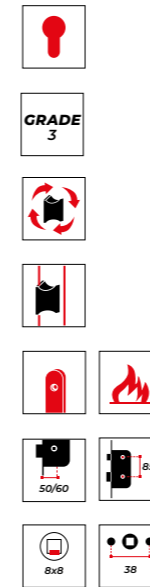
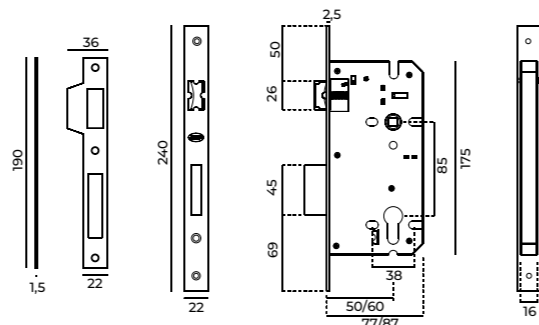

Mortise lock rounded Eurocylinder 60 / 50 - 85

IN.20.792.R.60 / Un.
IN.20.792.R.50 / Un.

Fechadura de embutir com cantos arredondados para cilindro europeu. Indicada para portas com uso elevado /
Mortise door lock with rounded corners for european cylinder. Recommended for doors with heavy use /
Cerradura de embutir con esquinas redondeadas para cilindro europeo. Indicada para puertas con uso elevado.

EN 1.4301 - AISI 304
Satinado / Satin

FIRE TEST EVIDENCE
EN12209 **3**H5110B3B|A3|0

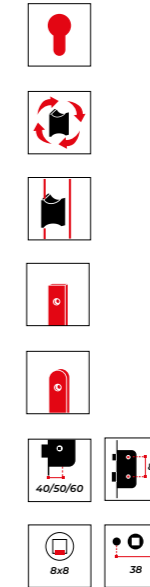
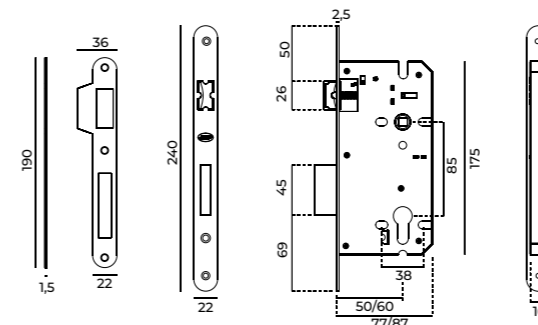

Mortise lock Eurocylinder 40 / 50 / 60 - 85

20.790.50.NS (SATIN NICKEL) / Un.
20.790.40.NS (SATIN NICKEL) / Un.
20.790.R.60 (SATIN NICKEL ECO) / Un.

Fechadura de embutir para cilindro europeu. Indicada para portas com uso elevado /
Mortise door lock for european cylinder. Recommended for doors with heavy use /
Cerradura de embutir para cilindro europeo. Indicada para puertas con uso elevado.

Níquel satinado /
Satin nickel / Níquel satinado

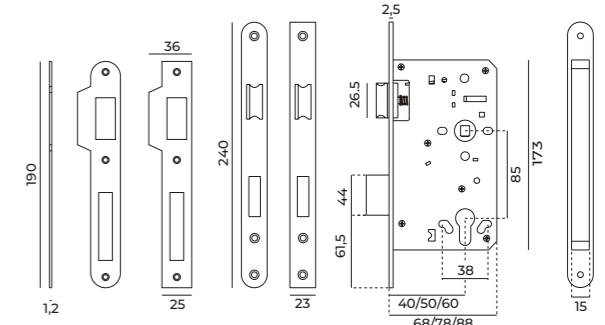

Unified case Series

Fechaduras desenvolvidas para a indústria de portas, permitindo mecanizar todas as folhas com a mesma medida, a escolha da fechadura pode ser efectuada na obra /

These locks were developed for the door industry. All the doors can be drilled with the same hole box. The choice of the lock can be made on site /

Série desarrollada para la industria de puertas. El cajeado es idéntico en todas las referencias. La cerradura puede ser elegida en obra.



1. Quadra com mola interior para eliminação da folga entre o puxador e quadra /
Handle square hole with a internal spring to avoid any break between the spindle and the lock / Nueca en acero inox con muelle interior para eliminar la holgura entre la manilla y nueca.

2. Furação para fixação do puxador / Handle fixing holes / Agujeros para tornillos pasantes.

3. Caixa fechada / Closed lock case / Caja cerrada.

4. Placa frontal de 23mm em aço inox EN 1.4301 / Front plate of 23mm in stainless steel EN 1.4301 / Placa frontal de 23mm de acero inoxidable EN 1.4301.

5. Trinco silencioso reversível com silenciador intermédio em nylon / Reversible silent latch with noise free nylon insert / Picaporte silencioso reversible con silenciador en nylon.

6. Frente amovível / Replaceble front plate / Frontal sustituible.

7. Chapa testa reversível / Reversible strike plate / Cerradero reversible.

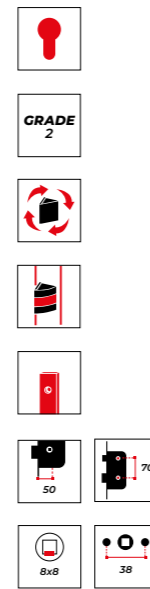

Mortise lock square Eurocylinder 50 / 70

IN.20.825.50 / Un.

Fechadura de embutir com cantos rectos para cilindro europeu /
Mortise door lock with square corners for european cylinder /
Cerradura de embutir con esquinas cuadradas para cilindro europeo.

EN 1.4301 - AISI 304
Satinado / Satin

EN12209 2B7000B2BA110

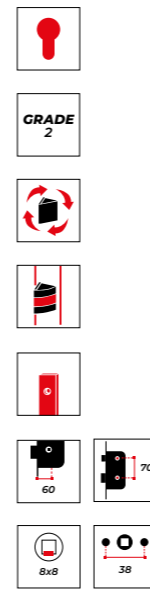
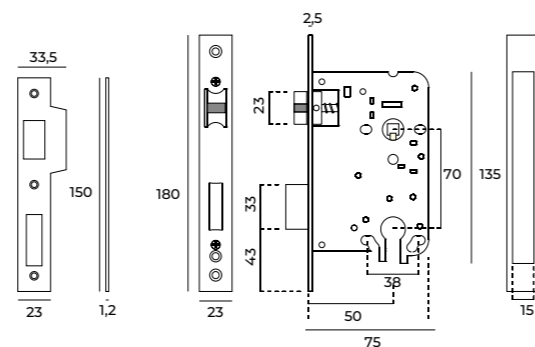

Mortise lock square Eurocylinder 60 / 70

IN.20.825.60 / Un.

Fechadura de embutir com cantos rectos para cilindro europeu /
Mortise door lock with square corners for european cylinder /
Cerradura de embutir con esquinas cuadradas para cilindro europeo.

EN 1.4301 - AISI 304
Satinado / Satin

EN12209 2B7000B2BA110

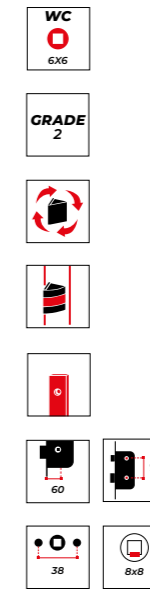
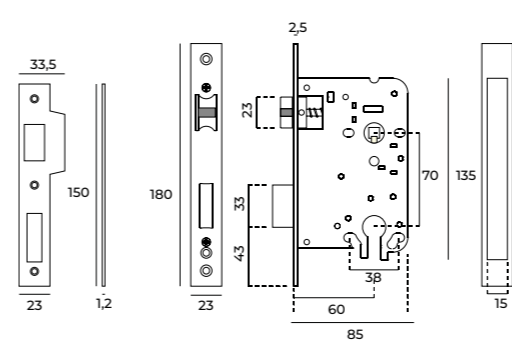

Mortise lock square Bathroom 60 / 70

IN.20.827 / Un.

Fechadura de embutir com cantos rectos para casa de banho /
Mortise door lock with square corners for bathroom use /
Cerradura de embutir con esquinas cuadradas para baño.

EN 1.4301 - AISI 304
Satinado / Satin

EN12209 2B7000B2BA110

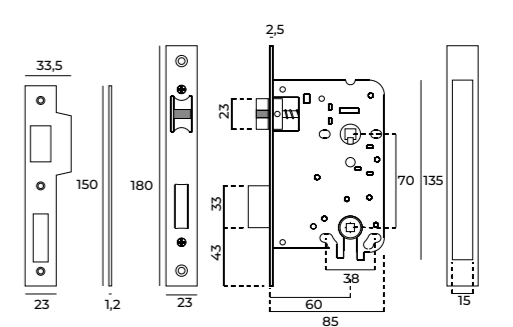

Unified case Series

Fechaduras desenvolvidas para a indústria de portas, permitindo mecanizar todas as folhas com a mesma medida, a escolha da fechadura pode ser efectuada na obra /

These locks were developed for the door industry. All the doors can be drilled with the same hole box. The choice of the lock can be made on site /

Série desarrollada para la industria de puertas. El cajeado es idéntico en todas las referencias. La cerradura puede ser elegida en obra.



1. Quadra com mola interior para eliminação da folga entre o puxador e quadra / Handle square hole with a internal spring to avoid any break between the spindle and the lock / Nueca en acero inox con muelle interior para eliminar la holgura entre la manilla y nueca.

2. Furação para fixação do puxador / Handle fixing holes / Agujeros para tornillos pasantes.

3. Caixa fechada / Closed lock case / Caja cerrada.

4. Placa frontal de 23mm em aço inox EN 1.4301 / 23mm front plate in stainless steel EN 1.4301 / Placa frontal de 23mm de acero inoxidable EN 1.4301.

5. Trinco silencioso reversível com silenciador intermédio em nylon / Reversible silent latch with noise free nylon insert / Picaporte silencioso reversible con silenciador en nylon.

6. Frente amovível / Replaceable front plate / Frontal sustituible.

7. Chapa testa ajustável e reversível / Adjustable and reversible strike plate / Cerradero regulable y reversible.

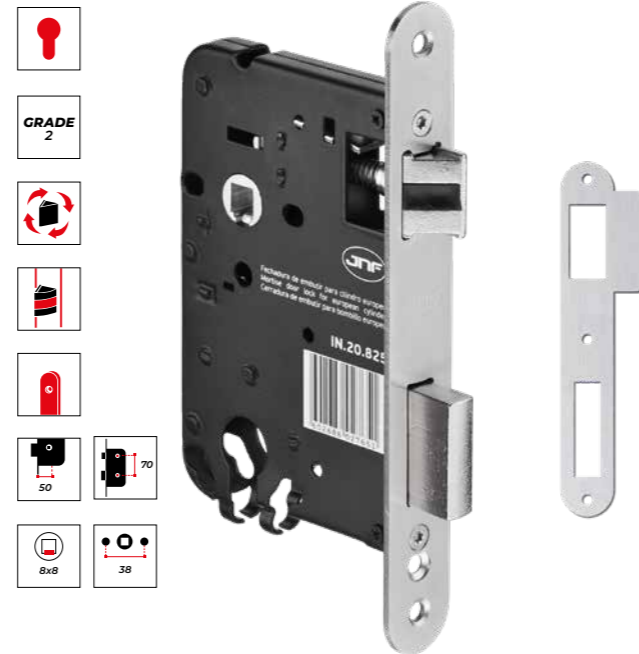

Mortise lock rounded Eurocylinder 50 / 70

IN.20.825.R.50 / Un.

Fechadura de embutir com cantos arredondados para cilindro europeu / Mortise door lock with rounded corners for european cylinder / Cerradura de embutir con esquinas redondeadas para cilindro europeo.

EN 1.4301 - AISI 304
Satinado / Satin

EN12209 2 B7|0|0|B2|B|A|1|0

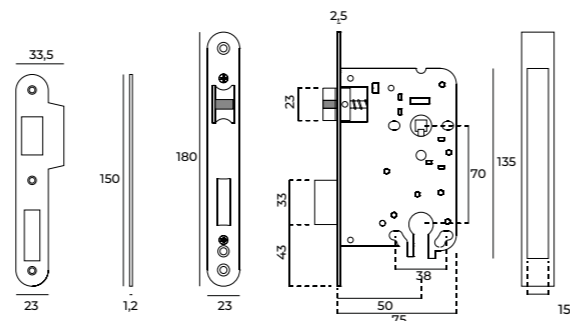

Mortise lock rounded Eurocylinder 60 / 70

IN.20.825.R.60 / Un.

Fechadura de embutir com cantos arredondados para cilindro europeu / Mortise door lock with rounded corners for european cylinder / Cerradura de embutir con esquinas redondeadas para cilindro europeo.

EN 1.4301 - AISI 304
Satinado / Satin

EN12209 2 B7|0|0|B2|B|A|1|0

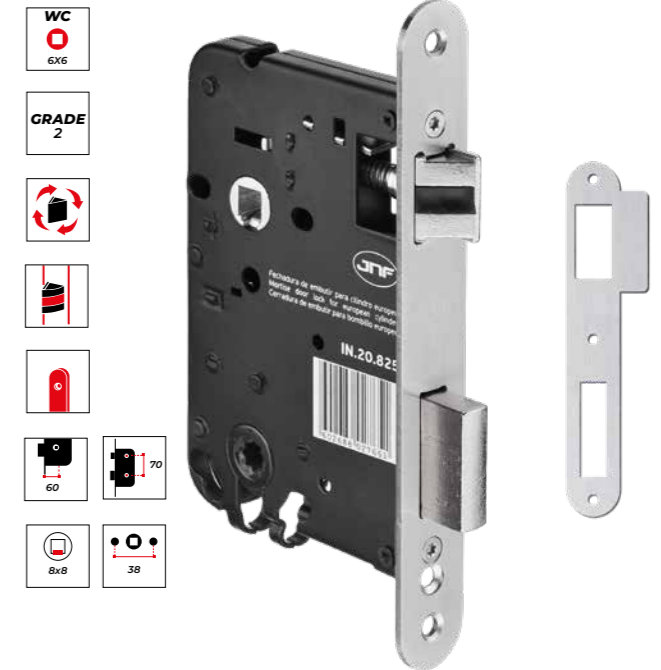
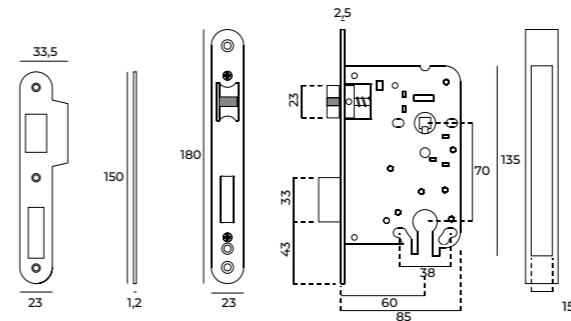

Mortise lock rounded Bathroom 60 / 70

IN.20.827.R / Un.

Fechadura de embutir com cantos arredondados para casa de banho / Mortise door lock with rounded corners for bathroom use / Cerradura de embutir con esquinas redondeadas para baño.

EN 1.4301 - AISI 304
Satinado / Satin

EN12209 2 B7|0|0|B2|B|A|1|0

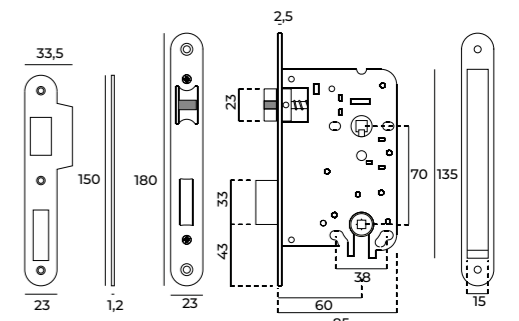

Magnetic Series

Fechaduras desenvolvidas para a indústria de portas. O sistema de trinco magnético permite um funcionamento silencioso e suave garantindo uma resistência e aspecto semelhante a uma fechadura tradicional.

These locks were developed for the door industry. The magnetic latch system allows a silent and smooth operation and at the same time ensures a similar look to a traditional lock.

Série desarrollada para la industria de puertas. La cerradura puede ser elegida en obra. El sistema de cierre magnético permite un funcionamiento silencioso y suave garantizando un bueno funcionamiento y un aspecto similar a una cerradura tradicional.



1. Quadra com mola interior para eliminação da folga entre o puxador e quadra /
Handle square hole with an internal spring to avoid any break between the spindle and the lock /
Nueca en acero inox con muelle interior para eliminar la holgura entre la manilla y la nueca.

2. Furação para fixação do puxador / Handle fixing holes /
Agujeros para tornillos pasantes.

3. Caixa fechada / Closed lock case /
Caja cerrada.

4. Trinco magnético metálico /
Metallic magnetic latch /
Picaporte magnético metálico.

5. Fecho em aço inoxidável /
Stainless steel dead bolt /
Pestillo de acero inox.

6. Frente amovível /
Replaceble front plate /
Frontal sustituible

7. Chapa testa ajustável e reversível /
Adjustable and reversible strike plate /
Cerradero regulable y reversible.



Magnetic lock 20mm Eurocylinder 60 / 70

IN.20.805.60.BA / Un.
(BLACK ANTHRACITE)

Fechadura de embutir magnética para cilindro Europeu. Indicada para portas com uso médio /
Magnetic mortise door lock for European cylinder. Recommended for doors with medium use /
Cerradura de embutir magnetica para cilindro Europeo. Indicada para puertas con uso mediano.

EN 1.4301 - AISI 304
Satinado / Satin

EN12209 **2 B700B2BA10**

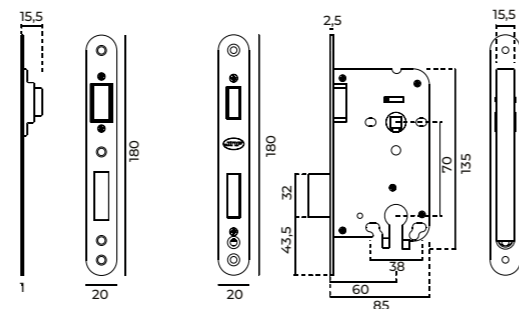

Silent latch lock Passage type 50

IN.20.818.50 / Un.
(SATIN)

Fechadura de embutir de passagem com cantos arredondos /
Mortise door lock with rounded corners passage type /
Cerradura de embutir de paso con esquinas redondeadas.

EN 1.4301 - AISI 304
Satinado / Satin

EN12209 **2 B700B2BD10**

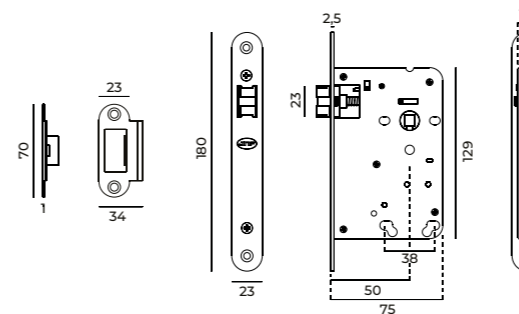

Silent latch lock Bathroom 50 / 70

IN.20.817.50 / Un.
(SATIN)

Fechadura de embutir com cantos arredondos para casa de banho /
Mortise door lock with rounded corners for bathroom use /
Cerradura de embutir con esquinas redondeadas para baño.

EN 1.4301 - AISI 304
Satinado / Satin

EN12209 **2 B700B2BD10**

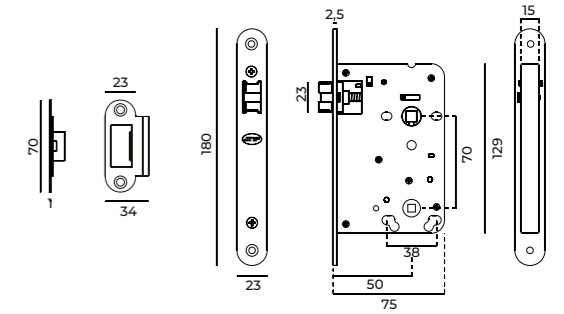

Industry Series

Fechaduras desenvolvidas para a indústria de portas, permitindo mecanizar todas as folhas com a mesma medida, a escolha da fechadura pode ser efectuada na obra /

Locks developed for the door industry. All the doors can be drilled with the same hole box. The choice of the lock can be made on site /

Série desenvolvida para la industria de puertas. El cajeado es idéntico en todas las referencias. La cerradura puede ser elegida en obra.



1. Quadra 8x8 com limitação de curso / 8x8 spindle with path limitation / Nueca 8x8 con limitación de curso.

2. Furação para fixação do puxador / Handle fixing holes / Agujeros para tornillos pasantes.

3. Caixa fechada / Closed lock case / Caja cerrada.

4. Trinco silencioso reversível em nylon / Reversible silent latch in nylon / Picaporte silencioso reversible en nylon.

5. Frente com 18mm / 18mm front plate / Frontal con 18mm

6. Chapa testa reversível / Reversible strike plate / Cerradero reversible.



Mortise door lock For european cylinder

IN.20.845 / Un.

Fechadura de embutir com cantos arredondados para cilindro europeu / Mortise door lock with rounded corners for european cylinder / Cerradura de embutir con esquinas redondeadas para cilindro europeo.

Níquel satinado / Satin nickel / Níquel satinado

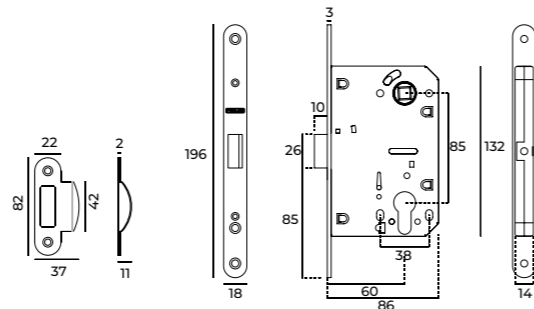

Mortise door lock For bathroom

IN.20.846 / Un.

Fechadura de embutir com cantos arredondados para casa de banho / Mortise door lock with rounded corners for bathroom / Cerradura de embutir con esquinas redondeadas para baño.

Níquel satinado / Satin nickel / Níquel satinado

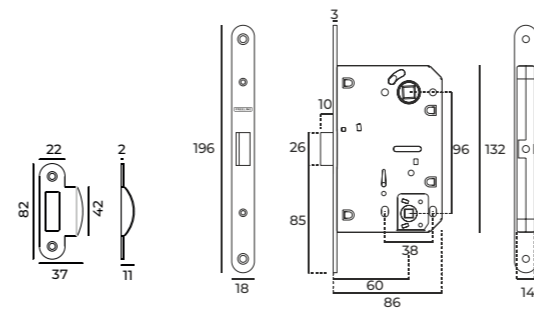

Converter EC Cylinder to normal key

IN.20.AKN (SATIN) / Un.
IN.20.AKN.RG (GOLD) / Un.
IN.20.AKN.RCO (COPPER) / Un.
IN.20.AKN.BA (BLACK) / Un.

Adaptador para chave normal / Adapter for normal key / Adaptador para llave normal.

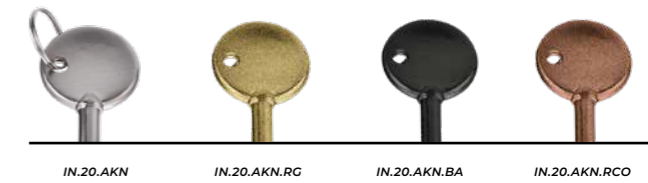

Converter WC Cylinder to wc

IN.20.AWC / Un.

Conversor para fechadura de casa de banho / Converter for toilet lock / Conversor para cerradura de condensa.



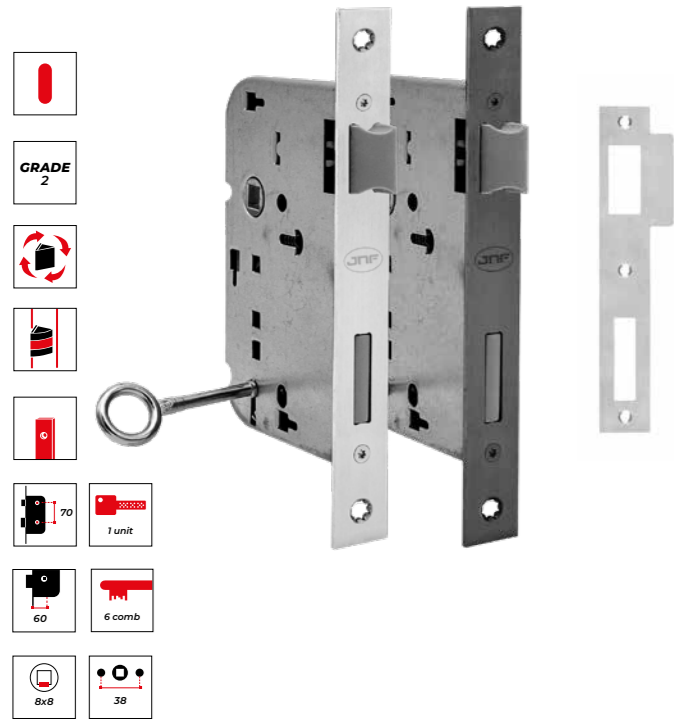

Residential lock

With normal key 60 / 70

IN.20.725 (SATIN) / Un.
IN.20.725.BA (BLACK ANTHRACITE) / Un.

Fechadura de embutir, de cantos rectos com chave normal /
Mortise door lock, with square corners for normal key /
Cerradura de embutir, de esquinas cuadradas con llave normal.

EN 1.4301 - AISI 304
Satinado / Satin

EN12209 2 C4|0|0|B|1|B|A|1|0|

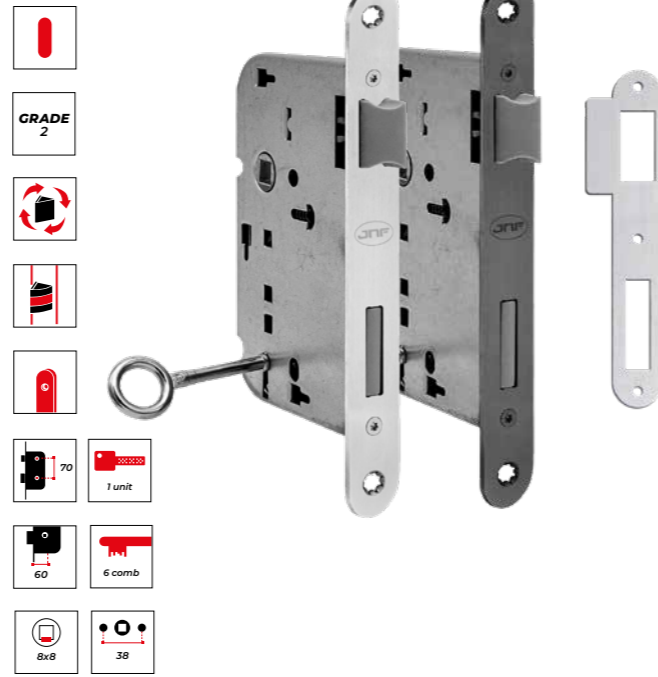
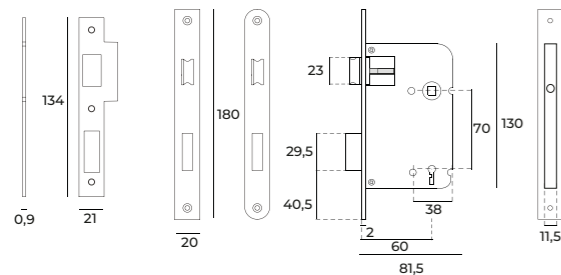

Residential lock

With normal key 60 / 70

IN.20.725.R (SATIN) / Un.
IN.20.725.R.BA (BLACK ANTHRACITE) / Un.

Fechadura de embutir, de cantos arredondos com chave normal /
Mortise door lock, with rounded corners for normal key /
Cerradura de embutir, de esquinas redondeadas con llave normal.

EN 1.4301 - AISI 304
Satinado / Satin

EN12209 2 C4|0|0|B|1|B|A|1|0|

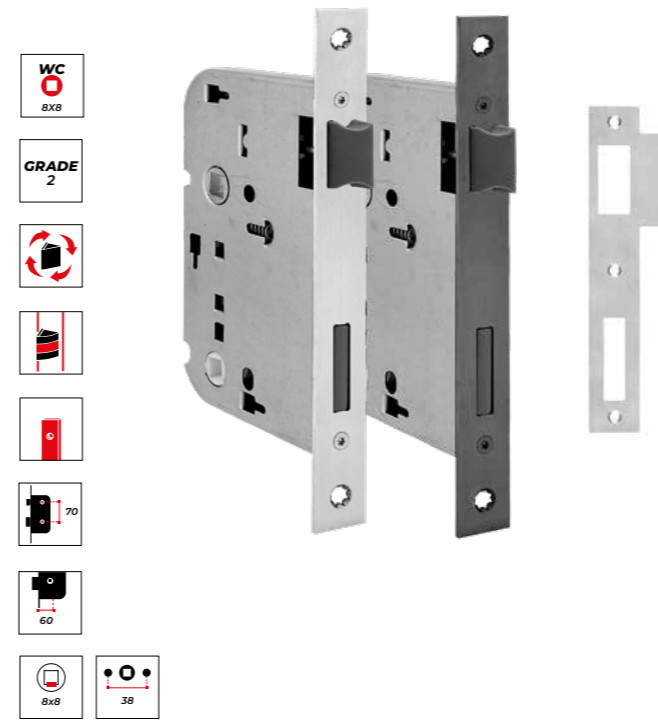
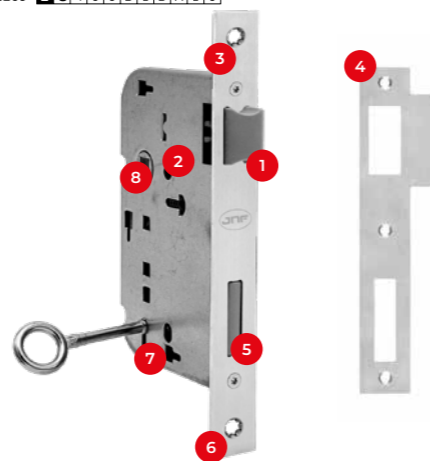

Residential lock

For bathroom 60 / 70

IN.20.726 (SATIN) / Un.
IN.20.726.BA (BLACK ANTHRACITE) / Un.

Fechadura de embutir com cantos rectos para casa de banho /
Mortise door lock with square corners for bathroom use /
Cerradura de embutir con esquinas cuadradas para baño.

EN 1.4301 - AISI 304
Satinado / Satin

EN12209 2 C4|0|0|B|1|B|A|1|0|



1. Trinco silencioso reversível em nylon reforçado com fibra de vidro /
Silent adjustable latch made in nylon reinforced with fiber glass /
Picoporte silencioso reversible en nylon reforzado con fibra de cristal.

2. Furação para fixação do puxador /
Holes for through handle screws /
Agujeros para tornillos pasantes.

3. Frente em aço inox disponível com cantos retos e arredondos /
Front plate made in stainless steel available with round and square edges /
Frente en acero inox disponible con cantos rectos y redondeados

4. Chapa testa reversível em aço inox disponível com cantos retos e arredondos /
Reversible strike plate available with round and square edges /
Cerradera reversible disponible con cantos rectos y redondeados.

5. Língua em nylon com reforço interior em aço /
Dead bolt made in nylon reinforced inside with steel /
Pestillo en nylon reforzado con hierro en interior.

6. Frente disponível em vários acabamentos: inox escovado, e antracite preto /
Front available in different finishes: satin stainless steel & black antracite /
Frente disponible en distintos acabados: acero inox sepillado y antracita negra.

7. Disponível com chave normal com 6 combinações diferentes ou para fecho wc com quadrado de 8x8mm /
Available for normal key with 6 different combinations or for wc snib indicator for 8x8mm spindle /
Disponível con llave normal con 6 combinaciones distintas o para condena de baño con cuadradillo de 8x8mm.

8. Zarelho metálico de 8x8mm reforçado /
Reinforced 8x8mm metallic follower /
Nuclea metálica de 8x8mm reforzada.

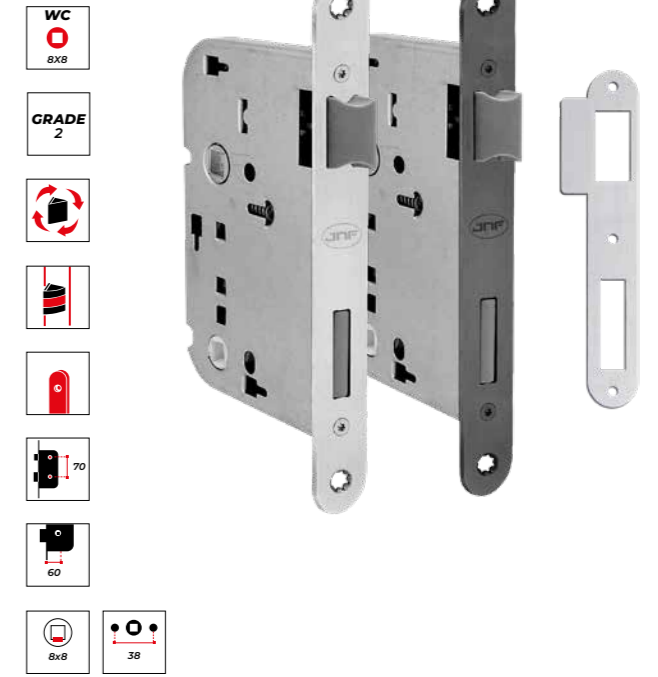

Residential lock

For bathroom 60 / 70

IN.20.726.R (SATIN) / Un.
IN.20.726.R.BA (BLACK ANTHRACITE) / Un.

Fechadura de embutir com cantos arredondos para casa de banho /
Mortise door lock with rounded corners for bathroom use /
Cerradura de embutir con esquinas redondeadas para baño.

EN 1.4301 - AISI 304
Satinado / Satin

EN12209 2 C4|0|0|B|1|B|A|1|0|

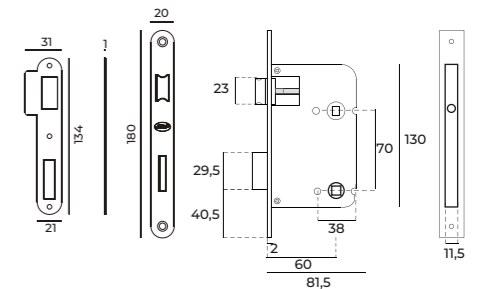

700 Series

A Série 700 foi criada para ser utilizada em portas interiores que estão sujeitas a uma utilização ligeira /

700 Series was created to be applied in interior doors that have a light use /

La serie 700 fue creada para ser aplicada en puertas interiores que se utilizan de un modo ligero.



1. Furação para fixação do puxador / Handle fixing holes /
Agujeros para tornillos pasantes.

2. Preparada para cilindro europeu / Ready for european cylinder /
Preparada para cilindro europeo.

3. Caixa fechada / Closed lock case /
Caja cerrada.

4. Trinco reversível em liga de zinco / Reversible latch made in zinc alloy /
Picaporte reversible en alienación de zinco.

5. Língua em aço / Dead bolt made in steel /
Pestillo en acero.

6. Frente em aço inox EN 1.4301 / Front plate made in stainless steel EN1.4301 /
Frente en acero inoxidable EN 1.4301.

7. Chapa testa reversível / Reversible strike plate /
Cerradero reversible.

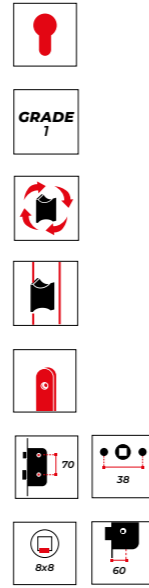

Mortise door lock Eurocylinder 60 / 70

IN.20.703 / Un.

Fechadura de embutir com cantos arredondos para cilindro europeu /
Mortise door lock with rounded corners for european cylinder /
Cerradura de embutir con esquinas redondeadas para cilindro europeo.

EN 1.4301 - AISI 304
Satinado / Satin

EN12209 **1**B4|0|0|B1|B|A|1|0



6 Un. 60 Un.

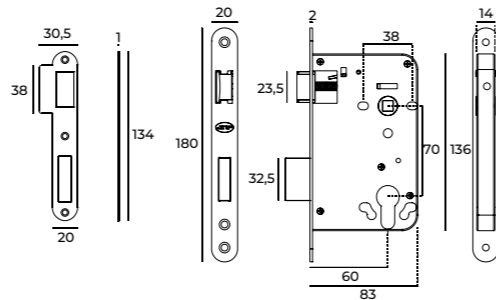

Converter EC Cylinder to normal key

IN.20.AKN (SATIN) / Un.
IN.20.AKN.RG (GOLD) / Un.
IN.20.AKN.RCO (COPPER) / Un.
IN.20.AKN.BA (BLACK) / Un.

Adaptador para chave normal /
Adapter for normal key /
Adaptador para llave normal.



1 Un. 10 Un.



IN.20.AKN IN.20.AKN.RG IN.20.AKN.BA IN.20.AKN.RCO



Converter WC Cylinder to wc

IN.20.AWC / Un.

Conversor para fechadura de casa de banho /
Converter for toilet lock /
Conversor para cerradura de condena.



1 Un. 25 Un.

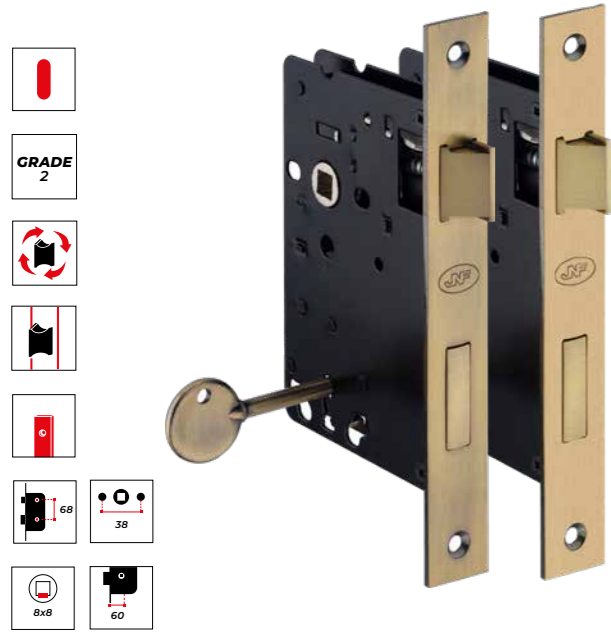

Residential lock

Normal key 60 / 68

IN.20.936.LB (SATIN BRONZE) / Un.
IN.20.936.LS (SATIN BRASS) / Un.

Fechadura de embutir com cantos rectos
com chave normal /
Mortise door lock with square corners
with normal key /
Cerradura de embutir con esquinas
cuadradas con llave normal.

EN12209 2 C400B2BA10

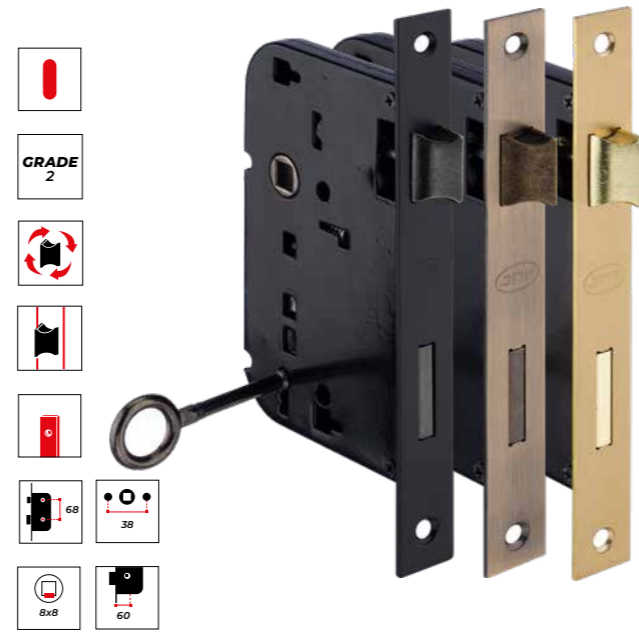
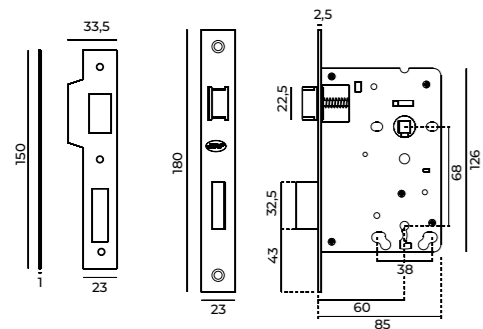

Residential lock

Normal key 55-60 / 68

20.716.60.FP (BLACK) / Un.
20.716.55.LB (SATIN BRONZE) / Un.
20.716.60.LS (SATIN BRASS) / Un.

Fechadura de embutir com cantos rectos
com chave normal /
Mortise door lock with square corners
with normal key /
Cerradura de embutir con esquinas
cuadradas con llave normal.

EN12209 2 C400B1BA10

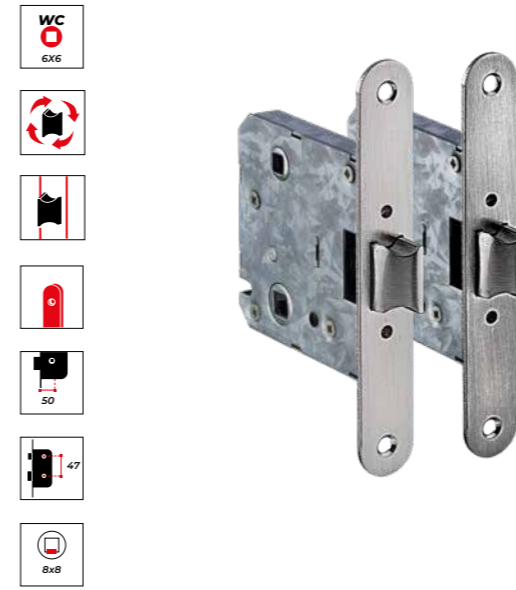
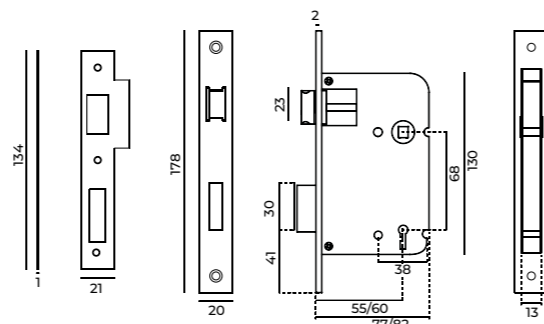

Picaporte

For bathroom 50 / 47

20.717.NS (SATIN NICKEL PLATED) / Un.
20.717.CM (MATTE CROME PLATED) / Un.

Fechadura de embutir com cantos redondos
para casa de banho /
Mortise door lock with rounded corners
for bathroom /
Cerradura de embutir con esquinas
redondeadas para baño.

Aço / Steel / Acero

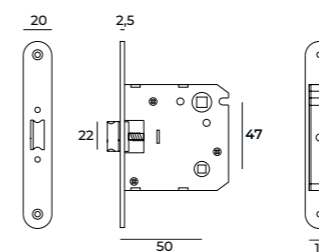
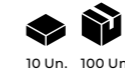

Picaporte

For bathroom 50 / 47

20.717.FL (BRASS PLATED) / Un.
20.717.LB (BRONZE PLATED) / Un.

Fechadura de embutir com cantos redondos
para casa de banho /
Mortise door lock with rounded corners
for bathroom /
Cerradura de embutir con esquinas
redondeadas para baño.

Aço / Steel / Acero

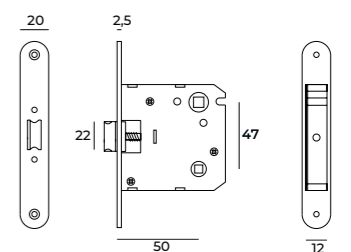



Service lock

With cross key

IN.20.630 / Un.



Fechadura de serviço com chave de cruz /
Lock service with cross key /
Cerradura de servicio con llave de cruz.

IN.20.630.1 / Un.



Fechadura de serviço com chave de cruz.
Grupos de chaves iguais /
Lock service with cross key. Key alike groups /
Cerradura de servicio con llave de cruz.
Grupos de llaves igualadas.

EN 1.4301 - AISI 304
Satinado / Satin

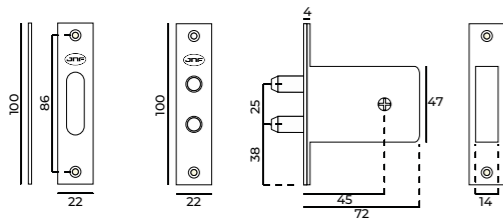

Ball catcher

Power adjustable

IN.17.011 / Un.



Retentor de porta /
Ball catcher /
Retenedor de puerta.

EN 1.4301 - AISI 304
Satinado / Satin

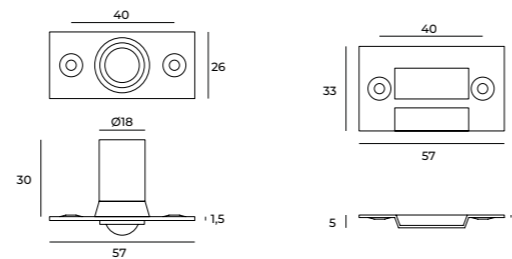



Mortise door lock

For sliding doors

20.237 / Set

Fechadura de embutir para portas de correr. Frente e chapa testa em aço inox EN 1.4301. Fornecida com conjunto de puxadores para embutir em níquel satinado / Mortise door lock for sliding doors. Front and strike plate made in stainless steel EN 1.4301. Supplied with complete set of flush handles made in satin nickel / Cerradura de embutir para puertas correderas. Frente y cerradero en acero inox EN 1.4301. Suministrada con conjunto de tiradores de embutir en níquelado satin.

EN 1.4301 - AISI 304
Satinado / Satin

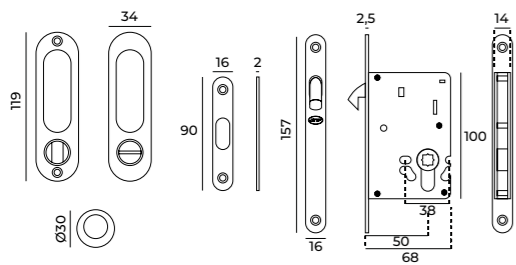

Mortise door lock

For sliding doors

IN.20.241.F / Set

Fechadura de embutir para portas de correr. Gancho, frente e chapa testa em aço inox EN 1.4301. Fornecida com conjunto de puxadores para embutir / Mortise door lock for sliding doors. Hook, front and strike plate made in stainless steel EN 1.4301. Supplied with complete set of flush handles / Cerradura de embutir para puertas correderas. Gancho, frente y cerradero en acero inox EN 1.4301. Suministrada con conjunto de tiradores de embutir.

EN 1.4301 - AISI 304
Satinado / Satin



EN12209 2 B 4 0 0 B 2 C D 0 0

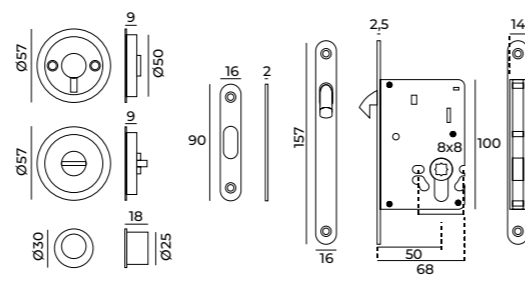

Mortise door lock

For sliding doors

20.938.NS / Set
(SATIN NICKEL)

Fechadura de embutir para portas de correr. Frente e chapa testa em aço inox EN 1.4301. Fornecida com conjunto de puxadores para embutir em níquel satinado / Mortise door lock for sliding doors. Front and strike plate made in stainless steel EN 1.4301. Supplied with complete set of flush handles made in satin nickel / Cerradura de embutir para puertas correderas. Frente y cerradero en acero inox EN 1.4301. Suministrada con conjunto de tiradores de embutir en níquelado satin.

EN 1.4301 - AISI 304
Satinado / Satin



EN12209 2 B 4 0 0 B 2 C D 0 0

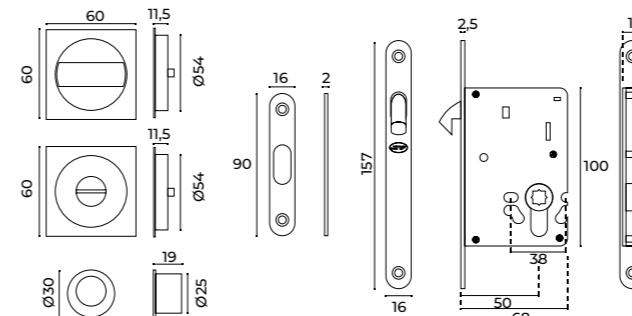

Mortise door lock

For sliding doors

20.938.BA / Set
(BLACK ANTHRACITE)

Fechadura de embutir para portas de correr. Gancho, frente e chapa testa em aço inox EN 1.4301. Fornecida com conjunto de puxadores para embutir / Mortise door lock for sliding doors. Hook, front and strike plate made in stainless steel EN 1.4301. Supplied with complete set of flush handles / Cerradura de embutir para puertas correderas. Gancho, frente y cerradero en acero inox EN 1.4301. Suministrada con conjunto de tiradores de embutir.

EN 1.4301 - AISI 304
Satinado / Satin



EN12209 2 B 4 0 0 B 2 C D 0 0

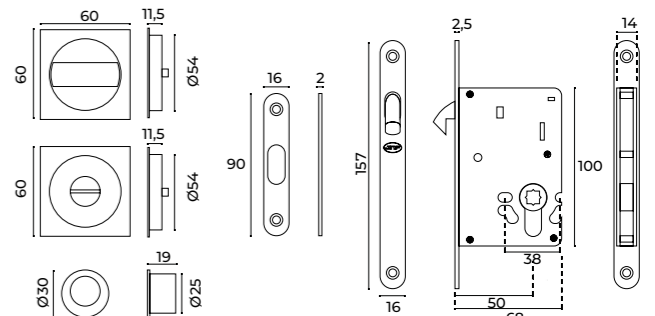



Mortise door lock

For sliding doors

20.938.RCO / Set
(RAW COPPER)

Fechadura de embutir para portas de correr. Gancho, frente e chapa testa em aço inox EN 1.4301. Fornecida com conjunto de puxadores para embutir / Mortise door lock for sliding doors. Hook, front and strike plate made in stainless steel EN 1.4301. Supplied with complete set of flush handles / Cerradura de embutir para puertas correderas. Gancho, frente y cerradero en acero inox EN 1.4301. Suministrada con conjunto de tiradores de embutir.

EN 1.4301 - AISI 304
Satinado / Satin



EN12209 2B400B2CD00

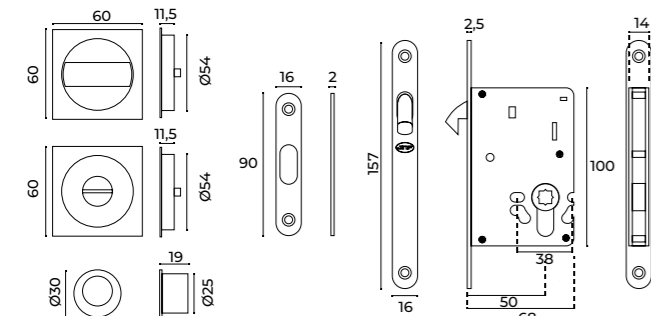

Mortise door lock

For sliding doors

20.937.NS / Set
(SATIN NICKEL)

Fechadura de embutir para portas de correr. Gancho, frente e chapa testa em aço inox EN 1.4301. Fornecida com conjunto de puxadores para embutir / Mortise door lock for sliding doors. Hook, front and strike plate made in stainless steel EN 1.4301. Supplied with complete set of flush handles / Cerradura de embutir para puertas correderas. Gancho, frente y cerradero en acero inox EN 1.4301. Suministrada con conjunto de tiradores de embutir.

EN 1.4301 - AISI 304
Satinado / Satin



EN12209 2B400B2CD00

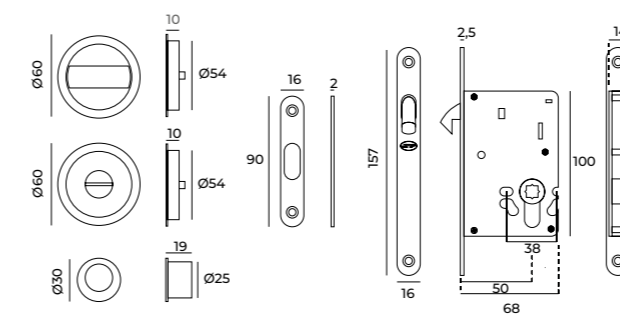

Mortise door lock

For sliding doors

20.938.RG / Set
(RAW GOLD)

Fechadura de embutir para portas de correr. Gancho, frente e chapa testa em aço inox EN 1.4301. Fornecida com conjunto de puxadores para embutir / Mortise door lock for sliding doors. Hook, front and strike plate made in stainless steel EN 1.4301. Supplied with complete set of flush handles / Cerradura de embutir para puertas correderas. Gancho, frente y cerradero en acero inox EN 1.4301. Suministrada con conjunto de tiradores de embutir.

EN 1.4301 - AISI 304
Satinado / Satin



EN12209 2B400B2CD00

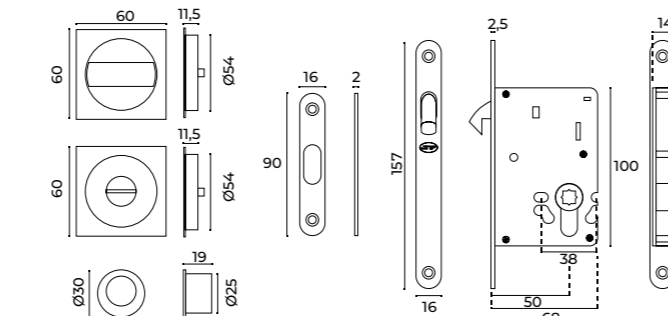

Mortise door lock

For sliding doors

20.937.LB / Set
(BRONZE)

Fechadura de embutir para portas de correr. Gancho, frente e chapa testa em aço inox EN 1.4301. Fornecida com conjunto de puxadores para embutir / Mortise door lock for sliding doors. Hook, front and strike plate made in stainless steel EN 1.4301. Supplied with complete set of flush handles / Cerradura de embutir para puertas correderas. Gancho, frente y cerradero en acero inox EN 1.4301. Suministrada con conjunto de tiradores de embutir.

EN 1.4301 - AISI 304
Satinado / Satin



EN12209 2B400B2CD00

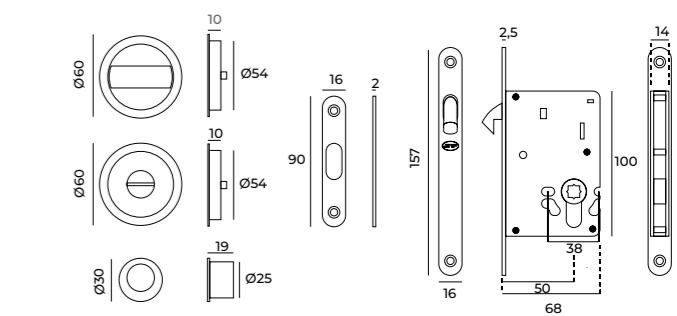



CAM lock / knob

With removable cylinder

20.4000 / Un.



Fechadura com cilindro
amovível /
Lock with removable
cylinder /
Cerradura con
cilindro amovible.

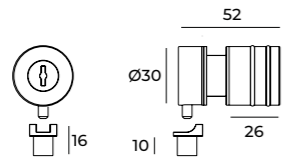

20.4000.CM

20.4000.CR

Technical keys

For 20.4000

20.4000.CM / Un.



Chave mestra /
Master key / Llave mestra.

20.4000.CR / Un.



Chave para remoção do cilindro /
Cylinder changing key / Llave para quitar el cilindro.

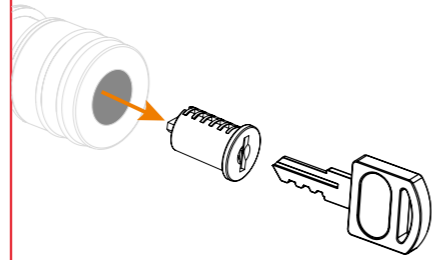

Removable cylinder

Easy change

20.4002.CI / Un.

Grupo de cilindros amovíveis com chaves iguais para fechadura
20.4000 / Removable cylinder group with key alike for lock
20.4000 / Grupo de cilindros amovibles con llaves iguales para
cerradura 20.4000.

20.4002.CD / Un.

Cilindros amovíveis com chaves diferentes para
fechadura 20.4000 / Removable cylinder with key
different for lock 20.4000 / Cilindros amovibles
con llaves distintas para cerradura 20.4000.

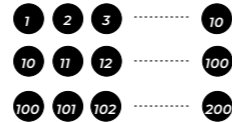

Number identifier

For 20.4000

20.4001 / Un.



Identificador para fechadura 20.4000
(Números - 1 a 200) /
Identifier for lock 20.4000
(Numerals - 1 to 200) /
Identificador para cerradura 20.4000
(Numeros - 1 a 200).



Cam lock

With 2 keys

07709.16 / Un.
07709.20 / Un.
07709.25 / Un.
07709.30 / Un.



Fechadura de apartado /
Cam lock /
Cerradura de levas.

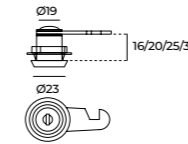

Universal Cam lock

Triangular key

IN.20.7708 / Un.



Fechadura de apartado universal /
Universal cam lock /
Cerradura de levas universal.

IN.20.7708.C / Un.



Chave para fechadura para IN.20.7708 /
Key for cam locks IN.20.7708 /
Llave para cerradura IN.20.7708.



Strike plate

For 20.4000

20.4003 / Un.



Chapa testa para fechadura 20.4000 /
Strike plate for lock 20.4000 /
Cerradero para cerradura 20.4000.

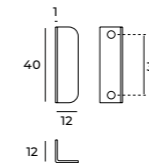



Lock

With removable cylinder

07715.20 / Un.
07715.25 / Un.
07715.30 / Un.



Fechadura com cilindro amovível /
Lock with removable cylinder /
Cerradura con cilindro amovible.

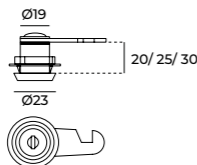

Lock

With removable cylinder

07715.Q.20 / Un.
07715.Q.25 / Un.
07715.Q.30 / Un.



Fechadura com cilindro amovível /
Lock with removable cylinder /
Cerradura con cilindro amovible.

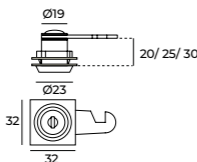

Lock

With removable cylinder

07715.R.20 / Un.
07715.R.25 / Un.
07715.R.30 / Un.



Fechadura com cilindro amovível /
Lock with removable cylinder /
Cerradura con cilindro amovible.

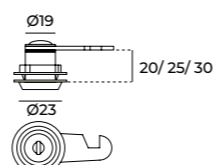

Cylinder

For lock

07715.C / Un.



Cilindro amovível para
fechadura IN.20.07715 /
Removable cylinder for
lock IN.20.07715 /
Cilindro amovible para
cerradura IN.20.07715.

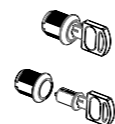

07715.CM



07715.CR

Technical keys

For 07715

07715.CM / Un.



Chave mestra /
Master key / Llave mestra.

07715.CR / Un.



Chave para remoção do cilindro /
Cylinder changing key /
Llave para quitar el cilindro.



Strike plate

For 20.4000

20.4003 / Un.



Chapa testa para
fechadura 20.4000 /
Strike plate for lock 20.4000 /
Cerradero para cerradura 20.4000.

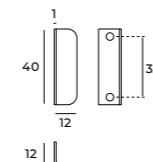



EASY
STANDALONE **ST**



Access control for lockers

IN.28.106 / Un.

Fechadura eletrónica para cacifos com cartão MIFARE. Permite funcionar em modo de autoprogramação (o usuário escolhe o cacifo livre ficando associado até nova abertura) Funciona sem fios usando 4 baterias AA 1,5V. Sistema de alimentação de emergência. Sistema de leitura através de com cartões MIFARE / Electronic lock for lockers with MIFARE system. Can work with self-programming mode. (the user chooses a free locker and is associated to this card until new opening) It works wirelessly using 4 AA batteries 1.5v. Emergency power system available. The reading system works with MIFARE cards / Cerradura electrónica para taquillas con tecnologia MIFARE. Sistema de auto-programación (el usuario elige el armario libre, se queda asociado hasta nueva apertura). Funciona de forma inalámbrica con 4 pilas AA de 1,5 V. Sistema de emergencia de energía. Sistema de lectura funciona con tarjetas MIFARE.

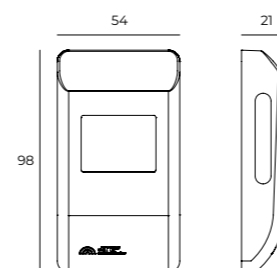

1 Un. 20 Un.

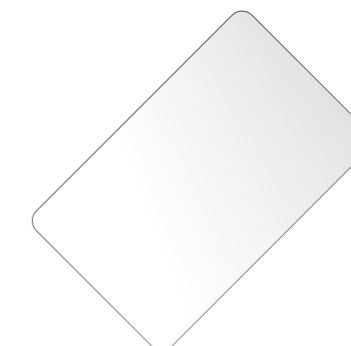

Generic Card MIFARE

IN.27.153.B / Un.

*Cartão genérico branco /
White generic card /
Tarjeta generica blanca.*



Power Supply External

IN.28.106.1 / Un.

*Alimentador externo para IN.28.106 /
External power supply for IN.28.106 /
Alimentación externa para IN.28.106.*

S20 Security cylinder

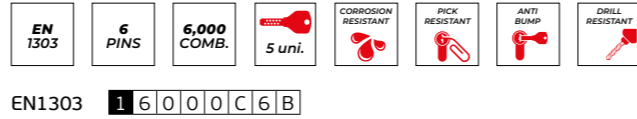

Cilindro de perfil europeu de segurança com 6 pinos activos.

Fornecido com 5 chaves, reversíveis, podendo ser introduzidas no cilindro em ambas as faces.

Esta família de cilindros satisfaz os seguintes requisitos da norma EN 1.303:

- Durabilidade ultrapassa largamente o grau 6, máximo requerido de 25,000 ciclos.
- Resistente à corrosão e temperatura, grau C máximo requerido

- O número de combinações ultrapassa 6,000
- Resistente ao ataque, grau 2, sistema anti brocagem, anti golpe, anti picking, resistente ao torque.

Security european profile cylinder with 6 active pins.

Supplied with 5 keys, reversible, which can be inserted into the cylinder on both sides.

This family of cylinders meets the following requirements of the standard EN 1.303:

- Durability greatly exceeds grade 6, maximum required of 25,000 cycles.
- Corrosion and temperature resistant, maximum required grade C.

- The number of combinations exceeds 6,000.
- Resistant to attack, grade 2, anti-drilling system, anti-knock, anti-picking, torque-resistant.

Cilindro de perfil de seguridad europeo con 6 pitones activos.

Se suministra con 5 llaves, reversibles, que se pueden insertar en el cilindro por ambos lados.

Esta familia de cilindros cumple los siguientes requisitos de la norma EN 1.303:

- La durabilidad supera con creces el grado 6, máximo requerido de 25,000 ciclos.

- Resistente a la corrosión y a la temperatura, grado C máximo requerido
- El número de combinaciones supera las 6,000
- Resistente al ataque, grado 2, sistema anti-punzonado, anti-knock, anti-picking, resistente al torque.

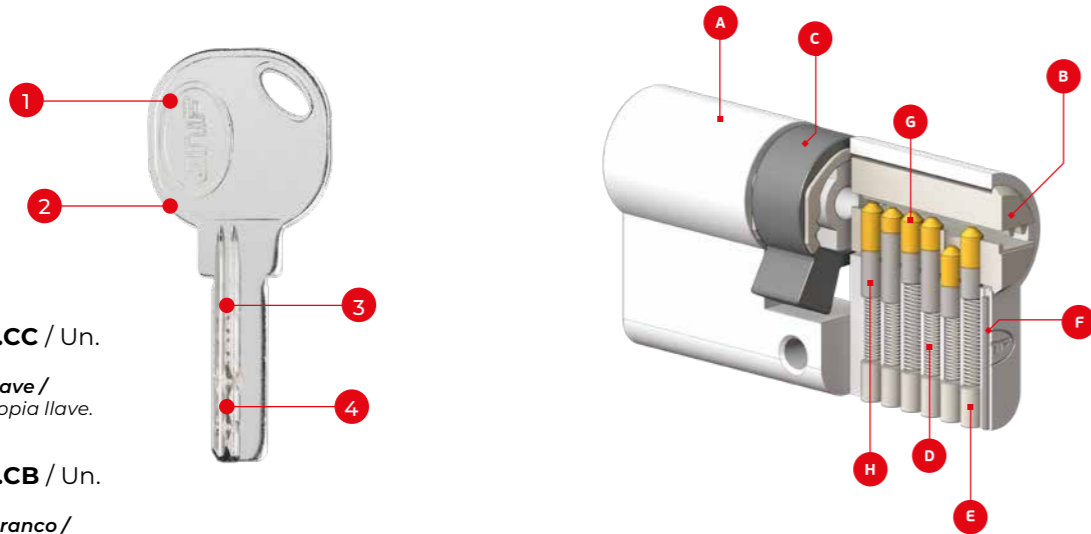

IN.19.524.CC / Un.

Cópia de chave / Key copy / Copia llave.

IN.19.524.CB / Un.

Chave em branco / Blank key / Llave en blanco.

- Fabricada em latão**
Made of brass / Hecha en latón
- Excelente aderência e ergonomia** / Excellent grip and ergonomics / Excelente agarre y ergonomía
- Resistente ao desgaste do perfil** / Wear resistant length profile / Resistente al desgaste del perfil
- Codificação lados distintos**
Distinctive side coding / Codificación lado distintive

- Corpo do cilindro**
Cylinder body / Cuerpo del cilindro
- Rotor / Cam / Rotor**
- Palhetão / Cam / Lleva**
- Mola / Spring / Muelle**
- Pinos de bloqueio**
Locking pins / Pitones de bloqueo
- Protecção anti brocagem**
Anti-drill protection / Protección anti taladro
- 6 pinos / 6 pins / 6 pitones**
- Pinos anti gazua**
No-picking pins / Protección antigazua



Embalagem Comercial
Commercial Packaging / Embalaje comercial



Como encomendar
How to order / como pedir

1 Referência do produto
Product reference / Referencia del producto

2 Medida do lado da chave
Side of key size / Tamaño lado llave

3 Medida do lado do botão
Side of button size / Tamaño lado del pomo

4 Adicionar o modelo do botão
Choose button / Agregar pomo

5 SB = sem botão
SB = no button / SB = sin pomo

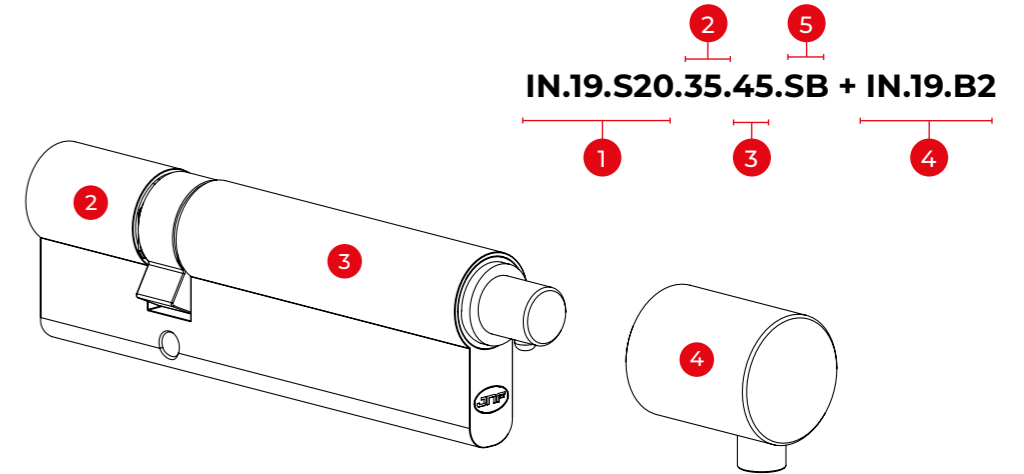

BOTÕES DISPONÍVEIS
Available knobs / Pomos disponibles

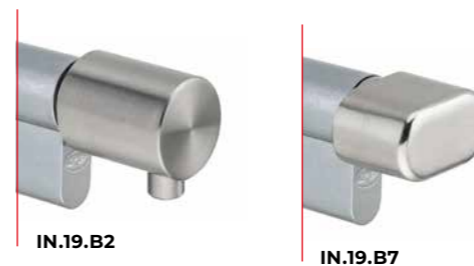

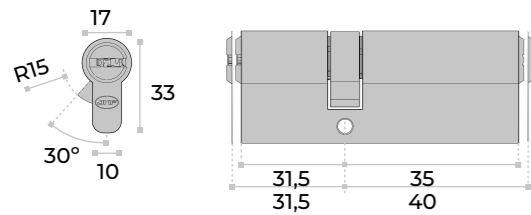

S20 Security Eurocylinder

IN.19.524.31.35 / Un.
IN.19.524.31.40 / Un.

Cilindro europeu chave-chave.
Cilindro de perfil europeu de segurança com 6 pinos activos.
Fornecido com 5 chaves, reversíveis, podendo ser introduzidas no cilindro em ambas as faces.
O número de combinações ultrapassa 6,000
Resistente ao ataque, grau 2, sistema anti brocagem, anti golpe, anti picking, resistente ao torque /

European cylinder key-key.
Security european profile cylinder with 6 active pins
Supplied with 5 keys, reversible, which can be inserted into the cylinder on both sides.
The number of combinations exceeds 6,000.
Resistant to attack, grade 2, anti-drilling system, anti-knock, anti-picking, torque-resistant /

Cilindro europeu llave-llave.
Cilindro de perfil de seguridad europeo con 6 pitones activos.
Se suministra con 5 llaves, reversibles, que se pueden insertar en el cilindro por ambos lados.
El número de combinaciones supera las 6,000
Resistente al ataque, grado 2, sistema anti-punzonado, anti-knock, anti-picking, resistente al torque.



1 Un. 24 Un.

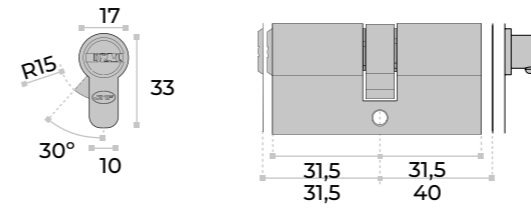

S20 Security Button / Eurocylinder

IN.19.524.31.31.SB / Un.
IN.19.524.31.40.SB / Un.

Cilindro europeu chave-botão.
Botão não incluído /
European cylinder key - button.
Button not included /
Cilindro europeu llave - pomo.
Botón no incluido.

IN.19.B2 / Un.
IN.19.B7 / Un.

Botão para cilindro europeu.
Button for European cylinder / Botón para el cilindro europeo.



IN.19.B2



IN.19.B7



1 Un. 24 Un.

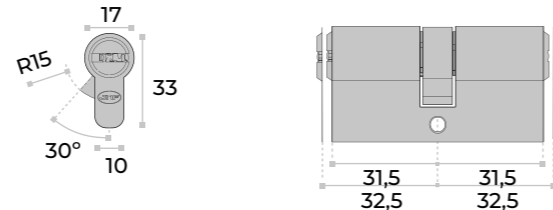

S20 Security Eurocylinder

IN.19.524.31.31 / Un.
IN.19.524.32.32 / Un.

Cilindro europeu chave-chave.
Cilindro de perfil europeu de segurança com 6 pinos activos.
Fornecido com 5 chaves, reversíveis, podendo ser introduzidas no cilindro em ambas as faces.
O número de combinações ultrapassa 6,000
Resistente ao ataque, grau 2, sistema anti brocagem, anti golpe, anti picking, resistente ao torque /

European cylinder key-key.
Security european profile cylinder with 6 active pins
Supplied with 5 keys, reversible, which can be inserted into the cylinder on both sides.
The number of combinations exceeds 6,000.
Resistant to attack, grade 2, anti-drilling system, anti-knock, anti-picking, torque-resistant /

Cilindro europeu llave-llave.
Cilindro de perfil de seguridad europeo con 6 pitones activos.
Se suministra con 5 llaves, reversibles, que se pueden insertar en el cilindro por ambos lados.
El número de combinaciones supera las 6,000
Resistente al ataque, grado 2, sistema anti-punzonado, anti-knock, anti-picking, resistente al torque.



1 Un. 24 Un.

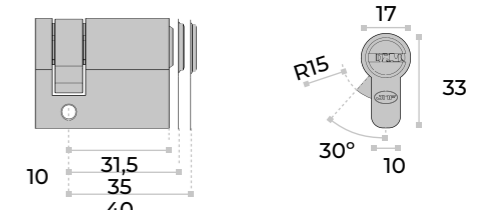

S20 Security Half Eurocylinder

IN.19.524.10.31 / Un.
IN.19.524.10.35 / Un.
IN.19.524.10.40 / Un.

Meio cilindro europeu para chave
Cilindro de perfil europeu de segurança com 6 pinos activos.
Fornecido com 5 chaves, reversíveis, podendo ser introduzidas no cilindro em ambas as faces.
O número de combinações ultrapassa 6,000
Resistente ao ataque, grau 2, sistema anti brocagem, anti golpe, anti picking, resistente ao torque.

Half european cylinder for key.
Security european profile cylinder with 6 active pins
Supplied with 5 keys, reversible, which can be inserted into the cylinder on both sides.
The number of combinations exceeds 6,000.
Resistant to attack, grade 2, anti-drilling system, anti-knock, anti-picking, torque-resistant.

Médio cilindro europeu para llave.
Cilindro de perfil de seguridad europeo con 6 pitones activos.
Se suministra con 5 llaves, reversibles, que se pueden insertar en el cilindro por ambos lados.
El número de combinaciones supera las 6,000
Resistente al ataque, grado 2, sistema anti-punzonado, anti-knock, anti-picking, resistente al torque.



1 Un. 24 Un.

S10 Standard cylinder

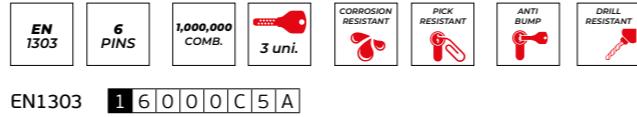

Cilindro de perfil europeu com 6 pinos activos.

European profile cylinder with 6 active pins.

Cilindro de perfil de seguridad europeo con 6 pitones activos.

Fornecido com 3 chaves de latão.

Supplied with 3 brass keys.

Se suministra con 3 llaves de latón.

Nesta gama de cilindros, disponibiliza-se 2 modelos de botões.

In this range of cylinders, we offer 2 button models.

En esta familia de cilindros se disponibilizan 2 modelos de botones.

Esta familia de cilindros satisfaz os seguintes requisitos da norma EN 1.303:

This family of cylinders meets the following requirements of the standard EN 1.303:

Esta familia de cilindros cumple los siguientes requisitos de la normativa EN 1.303:

- Durabilidade ultrapassa largamente o grau 6, máximo requerido de 25,000 ciclos.
- Resistente à corrosão e temperatura, grau C máximo requerido.
- O número de combinações ultrapassa 1,000,000 o que o coloca muito acima do grau 6 da norma EN 1.303.
- Resistente ao ataque, grau 2, sistema anti brocagem, anti golpe, anti picking, resistente ao torque.

- Durability greatly exceeds grade 6, maximum required of 25,000 cycles.
- Corrosion and temperature resistant, maximum required grade C.
- The number of combinations exceeds 1,000,000 which places it well above grade 5 of the EN 1.303 standard.
- Resistant to attack, grade 2, anti-drilling system, anti-knock, anti-picking, torque-resistant.

- La durabilidad supera con creces el grado 6, máximo requerido de 25,000 ciclos.
- Resistente a la corrosión y a la temperatura, grado C máximo requerido.
- El número de combinaciones supera las 1,000,000.
- Resistente al ataque, grado 2, sistema anti-punzonado, anti-knock, anti-picking, resistente al torque.

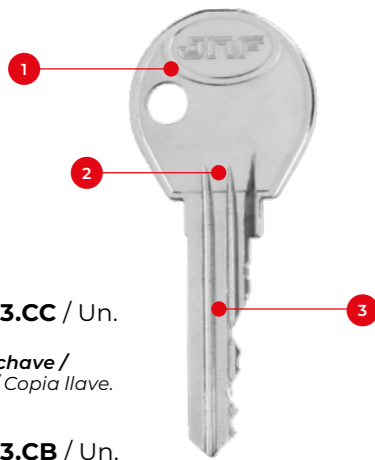

IN.19.523.CC / Un.

Cópia de chave /
Key copy / Copia llave.

IN.19.523.CB / Un.

Chave em branco /
Blank key / Llave en blanco.

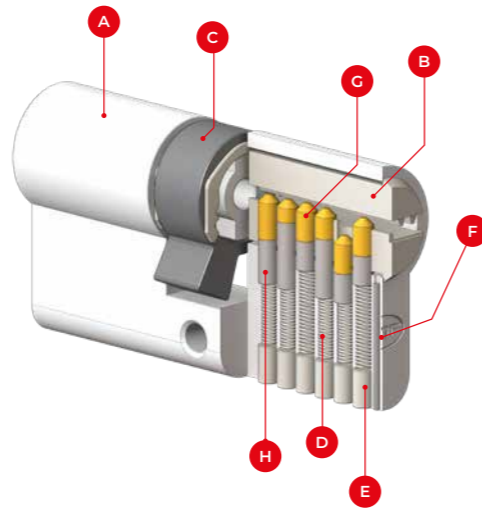

1. Fabricada em latão
Made of brass / Hecha en latón
2. Excelente aderência e ergonomia
Excellent grip and ergonomics
Excelente agarre y ergonomía
3. Resistente ao desgaste do perfil
Wear resistant length profile
Resistente al desgaste del perfil

- A. Corpo do cilindro
Cylinder body
Cuerpo del cilindro
- B. Rotor / Cam / Rotor
- C. Palhetão / Cam / Lleva
- D. Mola / Spring / Muelle
- E. Pinos de bloqueio
Locking pins
Pitones de bloqueo
- F. Protecção anti brocagem
Anti-drill protection
Protección anti taladro
- G. 6 Pinos / 6 Pins / 6 Pitones
- H. Pinos anti gazua
No-picking pins
Protección antigazua



Embalagem Comercial
Commercial Packaging / Embalaje comercial



Como encomendar
How to order / como pedir

- 1 Referência do produto
Product reference
Referencia del producto
- 2 Medida do lado da chave
Side of key size
Tamaño lado llave
- 3 Medida do lado do botão
Side of button size
Tamaño lado del pomo
- 4 Adicionar o modelo do botão
Choose button
Agregar pomo
- 5 SB = sem botão
SB = no button
SB = sin pomo

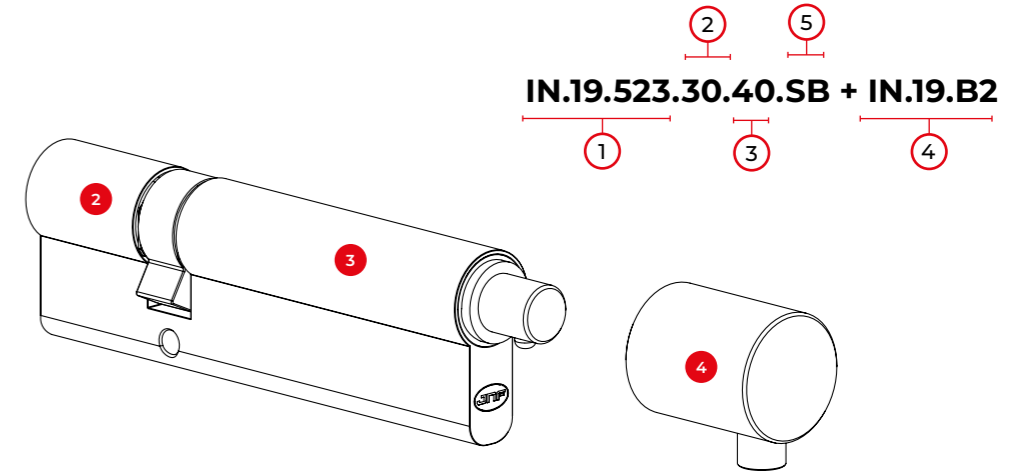

BOTÕES DISPONÍVEIS
Available knobs / Pomos disponibles



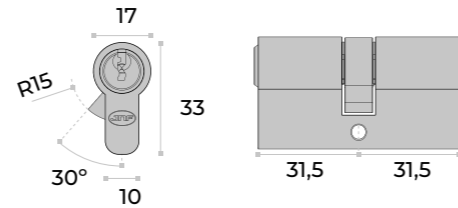
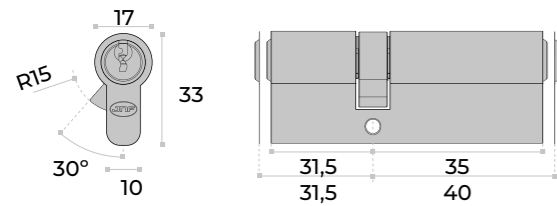

S10 Standard Eurocylinder

IN.19.523.31.35 / Un.
IN.19.523.31.40 / Un.

Cilindro europeu chave-chave.
Cilindro de perfil europeu com 6 pinos activos.
Fornecido com 3 chaves de latão.
Resistente ao ataque, grau 2, sistema anti brocagem, anti golpe, anti picking, resistente ao torque.

European cylinder key-key.
European profile cylinder with 6 active pins.
Supplied with 3 brass keys.
Resistant to attack, grade 2, anti-drilling system, anti-knock, anti-picking, torque-resistant.

Cilindro europeu llave-llave.
Cilindro de perfil de seguridad europeu con 6 pitones activos.
Se suministra con 3 llaves de latón.
Resistente al ataque, grado 2, sistema anti-punzonado, anti-knock, anti-picking, resistente al torque.

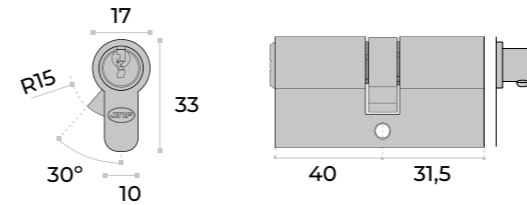

S10 Standard Button / Eurocylinder

IN.19.523.40.30.SB / Un.

Cilindro europeu chave-botão.
Botão não incluído /
European cylinder key - button.
Button not included /
Cilindro europeu llave - pomo.
Botón no incluido

IN.19.B2 / Un.
IN.19.B7 / Un.

Botão para cilindro europeu.
Button for European cylinder /
Botón para el cilindro europeu.



IN.19.B2



IN.19.B7



1 Un. 24 Un.



1 Un. 24 Un.

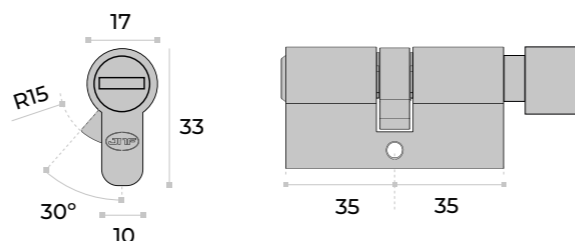
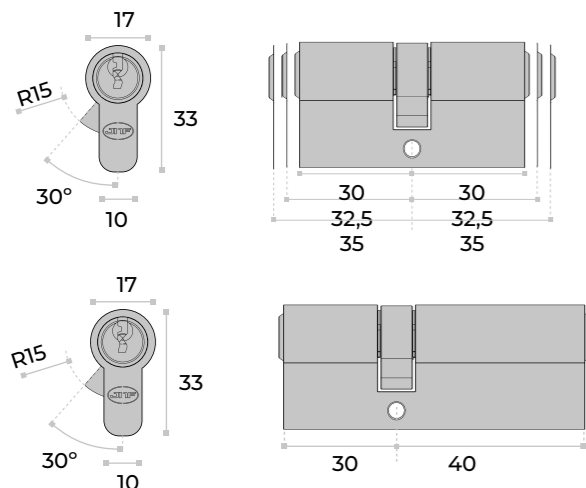

S05 Basic

Eurocylinder

IN.19.S05.30.30 / Un.
IN.19.S05.32.32 / Un.
IN.19.S05.35.35 / Un.
IN.19.S05.30.40 / Un.

*Cilindro europeu chave-chave.
Cilindro de perfil europeu com 5 pinos activos.
Fornecido com 3 chaves /*

*European cylinder key-key.
European profile cylinder with 5 active pins.
Supplied with 3 keys /*

*Cilindro europeo llave-llave.
Cilindro de perfil europeo con 5 pitones activos.
Se suministra con 3 llaves.*

IN.19.S05.CB / Un.

*Chave em branco /
Blank key /
Llave en blanco*



1 Un. 24 Un.

S04 Bathroom

Eurocylinder / Button

IN.19.S04.35.35.B7 / Un.

Cilindro de perfil europeu com função de wc. Pode ser usado numa fechadura de perfil europeu. Converte fechaduras de cilindro europeu em fechaduras de banho. Maior privacidade, permitindo a abertura rápida em caso de emergência com a rotação da fenda do lado exterior /

European profile cylinder with wc function. Can be used in a standard european profile lock. Converts european cylinder locks into a wc lock. Increased privacy while allowing a quick release in case of emergency with the slotted turn on the outside /

Cilindro de perfil europeo con función de wc. Se puede utilizar en una cerradura de perfil europeo. Convierte cerraduras de cilindro europeo en cerraduras de baño. Mayor privacidad, permitiendo una rápida apertura en caso de emergencia con la rotación de la grieta hacia el exterior.



1 Un. 24 Un.

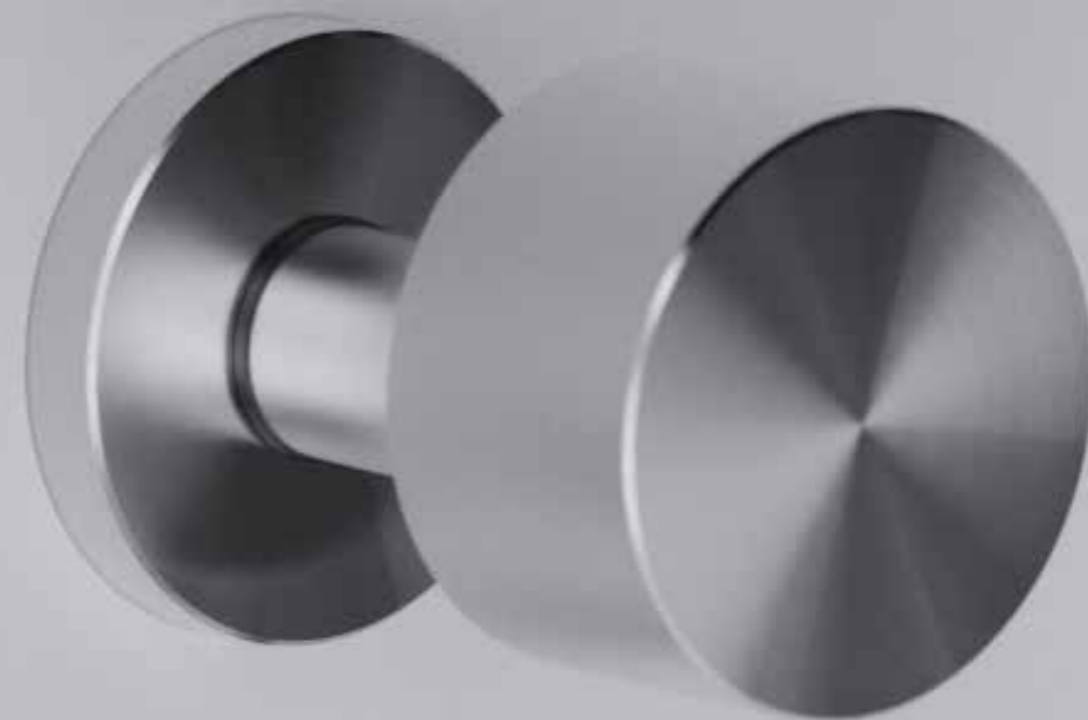

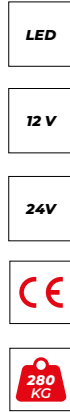

Electromagnetic lock

280 kg - holding force

IN.28.680 / Set



- **Fechadura eletromagnética**
- **Corpo em alumínio anodizado**
- **Sem magnetismo residual**
- **Força de retenção de 280kg**
- **Baixo consumo de 0,46A para 12 VDC e 0,23A para 24 VDC**
- **LED para controle de posição da porta**
- **Tratamento Anti-corrosão**
- **Aplicável em temperaturas de -60 a +80 °C**
- **Projeto para alimentação de 12 V ou 24 V DC**
- **Disponíveis vários acessórios de fixação.**

- **Electromagnetic lock**
- **Body made in anodized aluminum**
- **No residual magnetism**
- **Holding force of 280 kg**
- **Low consumption 0,46A for 12 VDC and 0,23A for 24 VDC**
- **LED light for door control**
- **Anti-corrosion protected**
- **Suitable for temperatures between -60 and +80°C**
- **Designed for connection to 12 V or 24 V DC supplies**
- **Available several different fixing accessories**

- **Cerradura electromagnética**
- **Cuerpo en aluminio anodizado**
- **Sin magnetismo residual**
- **Fuerza de sujeción de 280 kg**
- **Bajo consumo de 0,46A para 12 VDC y 0,23A para 24 VDC**
- **LED indicador de posición de la puerta**
- **Tratamiento anti-corrosión**
- **Aplicable en temperaturas desde -60 hasta 80 °C**
- **Diseñado para conexión de 12 V o 24 V DC**
- **Varios accesorios de montaje disponibles.**

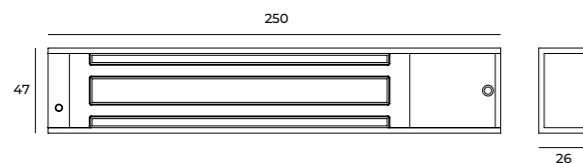

Z Bracket

For IN.28.680

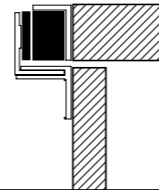

IN.28.684 / Set



Suporte em Z ajustável para IN.28.680 /
Adjustable Z bracket for IN.28.680 /
Soporte en Z ajustable para IN.28.680 /

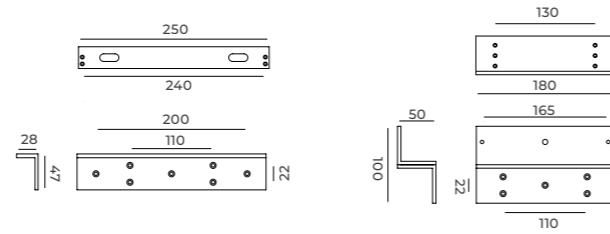

Glass clamp

For IN.28.680

IN.28.683 / Set



Pinça para porta em vidro aplicável com IN.28.680 /
Glass door clamp for IN.28.680 /
Pinza para puerta en cristal aplicable con IN.28.680 /

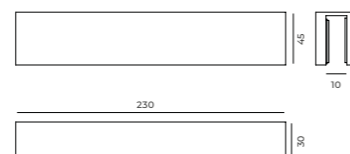

Drop pin lock

1000 kg - holding force

IN.28.505 / Set



- **Fechaduras eléctrica "DROP PIN".** Função aberto, só fecha com corrente eléctrica. A porta fica aberta com falha de corrente.
- **Entrada: 12 V DC**
- **Consumo: 0,9 A**
- **Ajuste de tempo de fecho: 0, 3, 6, 9 seg.**
- **Tampa em aço inoxidável**

- **Electric drop pin lock.** Open function, only lock with electric power. The door stays open when there is no power
- **Voltage: 12V DC**
- **Current: 0.9 A**
- **Time delay: 0, 3, 6, 9 sec.**
- **Stainless steel cover**

- **Cerradura eléctrica " DROP PIN"**
- **Funcion abierto, solo cierra con energía eléctrica.** La puerta se queda abierta con corte de energía
- **Corriente de entrada 12 V DC**
- **Consumo: 0,9 A**
- **Ajuste en el tiempo de cierre: 0, 3, 6, 9 seg.**
- **Cubierta en acero inoxidable.**

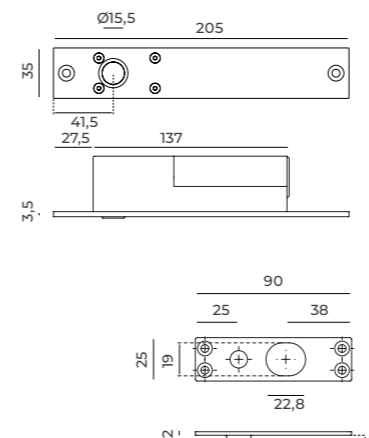

Strike box

For glass

IN.28.511 / Un.



Caixa testa para porta em vidro aplicável com IN.28.510 / Strike box for glass door for IN.28.510 / **Caja cerradero para puerta en cristal aplicable con IN.28.510.**

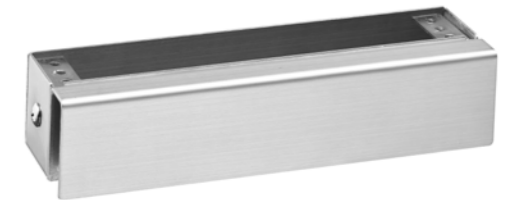
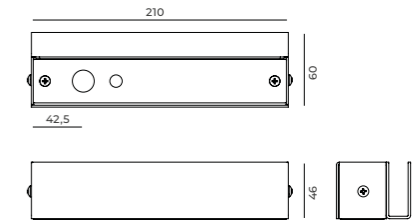

Box for drop pin

For glass

IN.28.510 / Un.



Caixa para aplicar IN.28.505 em porta de vidro / Box to install IN.28.505 in glass door / **Caja para aplicar IN.28.505 en puerta de cristal.**

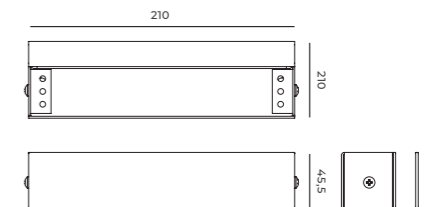



12V

100.000
CYCLES



Electric strike 12V

Fail secure

IN.20.654.A / Un.
IN.20.654.B / Un.
IN.20.654.C / Un.
IN.20.654.D / Un.
IN.20.654.E / Un.
IN.20.654.F / Un.



Testa eléctrica reversível. Corrente de entrada 12Vac-Dc. Trinco ajustável 4mm. Possibilidade de funcionar em modo de passagem. Possibilidade de instalar em diferentes frentes de aço inoxidável /

Reversible electric strike. Power input 12 Vac-Dc. Adjustable latch 4mm. Possible to work in passage mode. Possibility to install in different stainless steel front plates /

Cerradero eléctrico reversible. Corriente de entrada 12 Vac-Dc. Cerradero regulable 4 mm. Capacidad para trabajar en modo de paso. Posibilidad de instalar en diferentes frentes de acero inoxidable.

A - Modo de passagem / Passage mode / Modo de paso.

B - Função automática, permite deixar a porta aberta com um único e curto contacto eléctrico. A porta volta a ficar fechada, quando alguém entra e fecha reativando de novo o dispositivo /

Delay action, allows the door staying open with one small and unique electric contact. The door stays closed till anyone goes inside and close the door reactivating the system / Función automática permite dejar la puerta abierta con una única y corta alimentación eléctrica. La puerta vuelve estar cerrada solamente cuando alguien entra y cierra rearmando así el dispositivo.

C - Trinco ajustável 4mm / Adjustable latch 4mm / Cerradero regulable 4 mm.



IN.20.654.A
Testa curta /
Short strike plate /
Cerradero corto.



IN.20.654.B
Testa longa para
aluminio /
Long strike plate for
aluminium / Cerradero
largo para aluminio.



IN.20.654.C
Testa longa /
Long strike plate /
Cerradero largo.



IN.20.654.D
Testa longa direita
para madeira /
Right long strike
plate for wood /
Cerradero derecho
largo para madera.



IN.20.654.E
Testa longa esquerda
para madeira /
Left long strike plate
for wood / Cerradero
izquierdo largo para
madera.



IN.20.654.F
Testa longa /
Long strike plate /
Cerradero largo.



Power supply 12 Vdc

Output 1A + 1,5A

IN.28.110 / Un.



Fonte de alimentação.
Corrente de entrada 110 / 230 VAC.
Corrente de saída 12VDC.
- Ligação NC/NO.
- Temporizador de abertura
2 saídas de corrente
-1x saída de 1A - constante
-1x saída de 1,5A - controlada por activação e temporizada.

Power supply.
Input 110/230 VAC.
Output 12VDC.
Conexión NC/NO.
Opening timer.
2 Outputs
-1x constant 1A output
-1x timed and controlled by activation 1,5A

Fuente de alimentación.
Entrada 110/230VAC.
Salida 12VDC.
Conexión NC/NO.
Temporizador de apertura.
2 salidas de corriente
-1x salida de 1A - constante
-1x salida de 1,5A - controlada por activación y temporizada

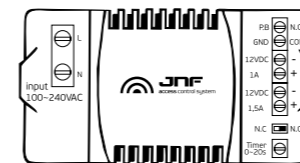

Power supply 12 Vdc

Output 1A

IN.28.112 / Un.



Fonte de alimentação.
Corrente de entrada 110 / 230 VAC.
Corrente de saída 12VDC.
-1x saída de 1A - constante

Power supply.
Input 110/230 VAC.
Output 12VDC.
-1x constant 1A output

Fuente de alimentación.
Entrada 110/230VAC.
Salida 12VDC.
-1x salida de 1A - constante

EXIT



DECLARAÇÃO DE DESEMPENHO / MARCAÇÃO CE
DECLARATION OF PERFORMANCE (DOP) / CE MARKING/
DECLARACIÓN DE PRESTACIONES / MARCADO CE

O Regulamento (UE) n.º 305/2011 entrou em vigor em 1 de Julho de 2013, o qual estabelece condições harmonizadas para a comercialização dos produtos de construção e revoga a Directiva 89/106/CEE.

O presente regulamento obriga os fabricantes de produtos de construção a elaborar uma declaração de desempenho quando um produto de construção abrangido por uma norma harmonizada ou conforme com uma Avaliação Técnica Europeia emitida para esse produto.

Ao fazer a declaração de desempenho, o fabricante assume a responsabilidade legal pela conformidade do produto de construção com o desempenho declarado. Se a declaração de desempenho não tiver sido efetuada pelo fabricante, a marcação CE não pode ser aposta.

As barras anti-pânico só podem apresentar a marcação CE quando as mesmas têm utilização prevista em portas em caminhos de evacuação. Neste caso deve-se seguir o Sistema 1 de avaliação e verificação da regularidade do desempenho. Norma harmonizada para fechaduras: EN1125 - Dispositivos de fecho anti-pânico para saídas de emergência acionados por uma barra horizontal

The Regulation (EU) No 305/2011 entered in to force on July 1, 2013, laying down harmonised conditions for the marketing of construction products and repealing Council Directive 89/106/EEC.

This regulation requires manufacturers of construction products to draw up a declaration of performance when a construction product covered by a harmonised standard, or complies with an European Technical Assessment issued for this product.

Making a declaration of performance, the manufacturer assumes legal responsibility for the conformity of the product with the declared performance. If the performance statement hasn't been made by the manufacturer, CE marking cannot be affixed.

The antipanic lock must have the CE marking when they have an intended use for doors on escape route. In this case should follow the System 1 of assessment and verification of constancy of performance. Harmonised Standard for locks: EN1125 - Panic exit devices operated by a horizontal bar.

El Reglamento (UE) n.º 305/2011 entró en vigor en 1 Julio 2013, que establece condiciones armonizadas para la comercialización de los productos de construcción y se deroga la Directiva 89/106 / CEE.

Esta regulación exige a los fabricantes de productos de construcción a elaborar una declaración de prestaciones cuando un producto de construcción cubierto por una norma armonizada, o cumple con una evaluación técnica europea emitida para este producto.

Hacer una declaración de prestaciones, el fabricante asume la responsabilidad legal de la conformidad del producto con las prestaciones declaradas. Si la declaración de prestaciones no hay sido hecha por el fabricante, el marcado CE no puede ser fijado.

La cerradura antipánico debe tener el marcado CE cuando tienen un uso previsto para puertas en ruta de escape. En este caso, debe seguir el Sistema 1 de evaluación y verificación de la constancia de las prestaciones. Norma armonizada para cerraduras : EN1125 - Dispositivos antipánico para salidas de emergencia accionadas por una barra horizontal.

ICONOGRAFIA / ICONOGRAPHY / ICONOGRAFÍA

- Fechadura para porta anti-pânico /**
Lock for antipanic door /
Cerradura para puerta antipánico.
- Barra horizontal com fecho vertical /**
Horizontal panic device with upper and lower latch /
Barra horizontal con cierra vertical.
- Trinco lateral /**
Lateral latch /
Picaporte lateral.
- Marcação CE /**
CE Marking /
Marcado CE.
- Barra anti-pânico reversível /**
Antipanic reversible Lock /
Cerradura Antipánico reversible.
- Puxador rotativo no exterior /**
Lever handle from outside
Manilla por el exterior.
- Certificadas segundo a Norma Europeia /**
Certified according to the European Norm /
Certificadas segundo la Norma Europea.
- Utilização para sistemas Corta Fogo /**
Use for Fire proof systems /
Uso para sistemas corta fuego.
- Sem funcionamento pelo exterior /**
Without access from outside /
Sin funcionamiento por el exterior.
- Barra horizontal /**
Horizontal panic device /
Barra horizontal.
- Número de chaves por cilindro /**
Number of keys by cylinder /
Numero de llaves.
- Puxador fixo no exterior /**
Fixed Knob from outside
Pomo Fijo por el exterior.
- Aplicável com fechadura de embutir /**
Applicable with mortice lock /
Aplicable con cerradura de embutir.
- Permite planos de mestragem /**
Allows plans of master key system /
Capacidad de crear planos de amestramiento.
- Por chave pelo exterior /**
With key from outside /
Por llave por el exterior.

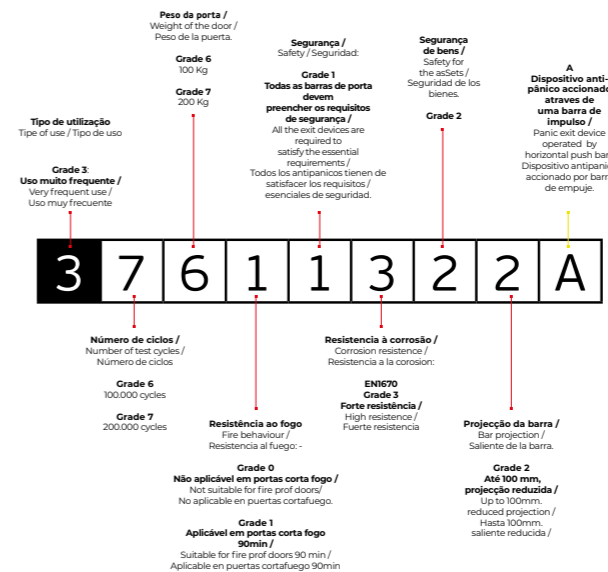

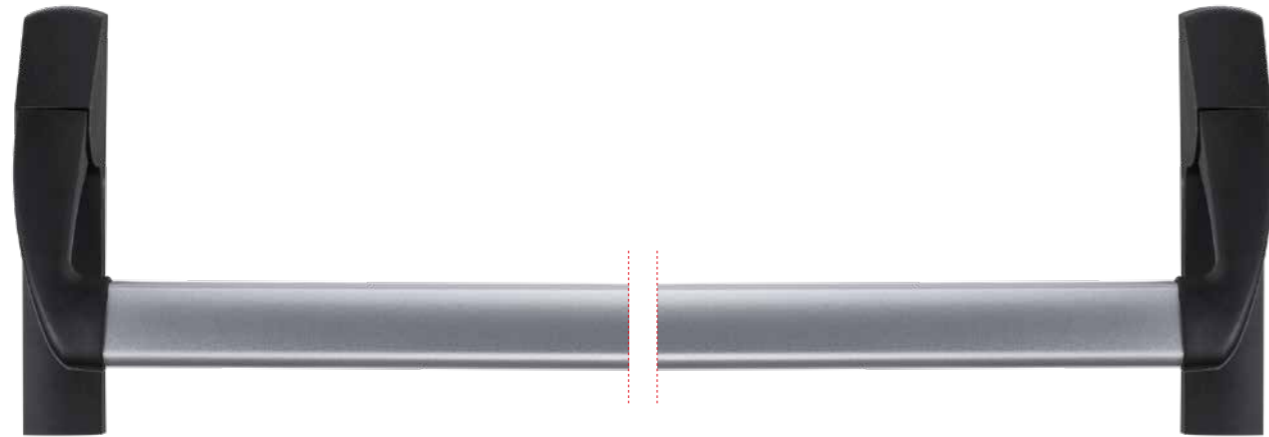

Reversible antipanic

RAL 9006 + 9005

FA.20.945 / Un.

Barra anti-pânico reversível. Sem trinco lateral. Aplicável com fechadura de embutir IN.20.960. Abertura por chave através do exterior. Puxador rotativo com placa e cilindro não incluídos / Reversible antipanic door lock. Without side latch. Applicable with mortise lock IN.20.960. Opening by key from the outside. Lever handle with plate and cylinder not included / Cerradura antipánico reversible. Sin picaporte basculante. Aplicable con cerradura de embutir IN.20.960. Apertura por llave por el exterior. Manilla, placa y cilindro no inclusos.

Alumínio / Aluminium + Plástico / Plastic
RAL 9006 (cinza / grey / gris) + RAL 9005 (preto / black / negro)

3 7 5 - 1 3 2 2 A B

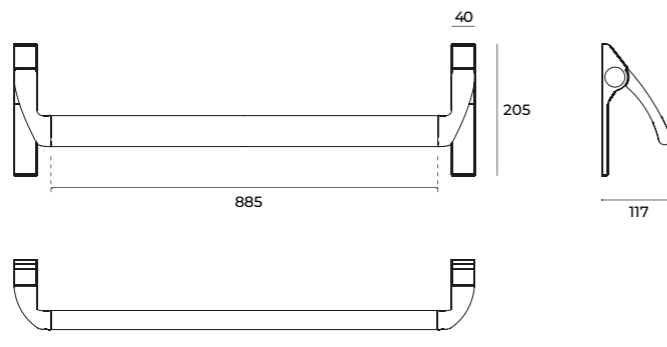

Handle on plate

Black RAL 9005

FA.03.940 / Un.

Placa com puxador. Compatível com: FA.20.945 / Plate with handle. Suitable for: FA.20.945 / Placa con manilla. Compatible con: FA.20.945.



Plate for Eurocylinder

Black RAL 9005

FA.20.946 / Un.

Placa para cilindro. Compatível com: FA.20.945 / Plate for cylinder. Suitable for: FA.20.945 / Placa para cilindro. Compatible con: FA.20.945.



Mortise lock

EN 179 / 12209

IN.20.960 / Un.

Fechadura de embutir corta fogo. Funciona com barra antipânico IN.20.945 / Fireproof mortise lock. Works with IN.20.945 anti-panic bar / Cerradura de embutir cortafuego. Funciona con dispositivo antipánico IN.20.945.

EN12209 3 B 4 B 0 C 2 0
EN179 3 6 5 B 1 3 3 2 A B

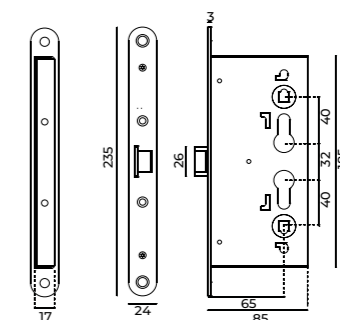

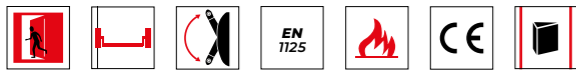

Exit device side latch RAL 9006

FA.20.951 / Un.



Barra anti-pânico reversível para porta de 1 folha. Fecho através de trinco lateral. Sem funcionamento através do exterior / Antipanic reversible lock for single doors. Closing system through a side latch. Without access from external side / Cerradura antipánico reversible para puertas de 1 hoja. Cierre por picaporte basculante lateral. Sin funcionamiento por el exterior.

Alumínio / Aluminium + Plástico / Plastic
RAL 9006 (cinza / grey / gris) + RAL 9005 (preto / black / negro)

3 7 5 - 1 3 2 2 A B

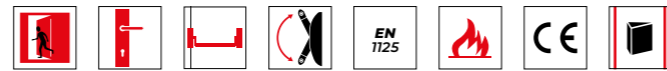
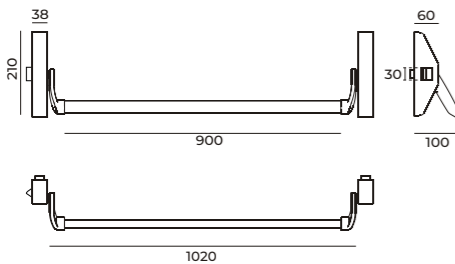

Exit device side latch Outside handle + cylinder

FA.20.952.KIT / Un.



Barra anti-pânico reversível para porta de 1 folha. Fecho através de trinco lateral. Abertura por chave através do exterior. Puxador rotativo com placa e cilindro incluídos / Antipanic reversible lock for single doors. Closing system through a side latch. Opening by key from the outside. Lever handle with plate and cylinder included / Cerradura antipánico reversible para puertas de 1 hoja. Cierre por picaporte basculante lateral. Apertura por llave por el exterior. Manilla, placa y cilindro incluidos.

RAL 9006 (cinza / grey / gris)

3 7 5 - 1 3 2 2 A B

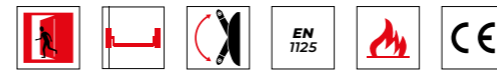
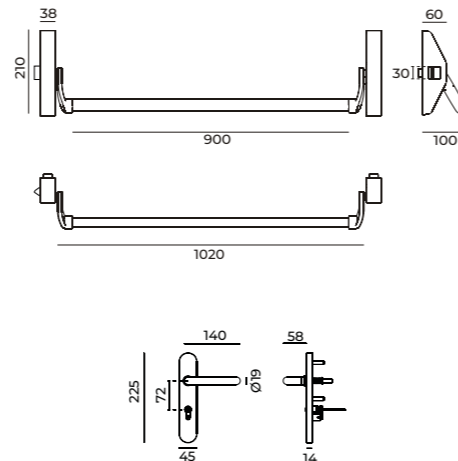

Exit device up and down RAL 9006

FA.20.953 / Un.



Barra anti-pânico para portas de 2 folhas. Instalação na folha passiva. Fecho através de trinco superior e inferior. Pode ser instalada conjuntamente com as barras IN.20.951 e IN.20.952. Funcionamentos possíveis através do exterior são determinados pela fechadura da folha activa / Antipanic lock for double doors. Installation at the secondary door. Closing system through upper and lower latch. This lock can be installed with the lock IN.20.951 and IN.20.952. The possible operations from the outside will be determined by the main door lock / Cerradura antipánico para puertas de 2 hojas. Cierre por picaporte superior y inferior. Cerradura para la puerta pasiva. Esta cerradura se puede instalar con la cerradura IN.20.951 y IN.20.952. El funcionamiento exterior es determinado por la cerradura de la puerta activa.

RAL 9006 (cinza / grey / gris)

3 7 5 - 1 3 2 2 A B

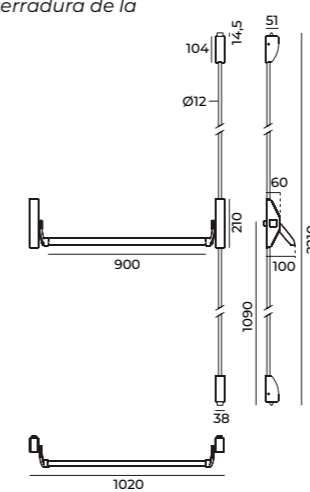

Exit device up and down Outside handle + cylinder

FA.20.954.KIT / Un.



Barra anti-pânico reversível. Fecho através de trinco superior e inferior. Abertura por chave ou puxador através do exterior. Puxador com placa e cilindro incluídos / Antipanic reversible lock. Closing system through upper and lower latch. Opening by key and lever handle from the outside. Lever handle with plate and cylinder included / Cerradura antipánico reversible. Cierre por picaporte superior y inferior. Apertura por llave y manilla por el exterior. Manilla, placa y cilindro incluidos.

RAL 9006 (cinza / grey / gris)

3 7 5 - 1 3 2 2 A B

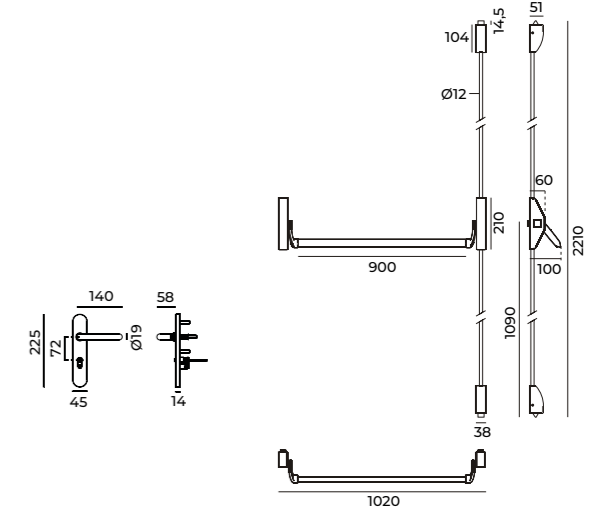

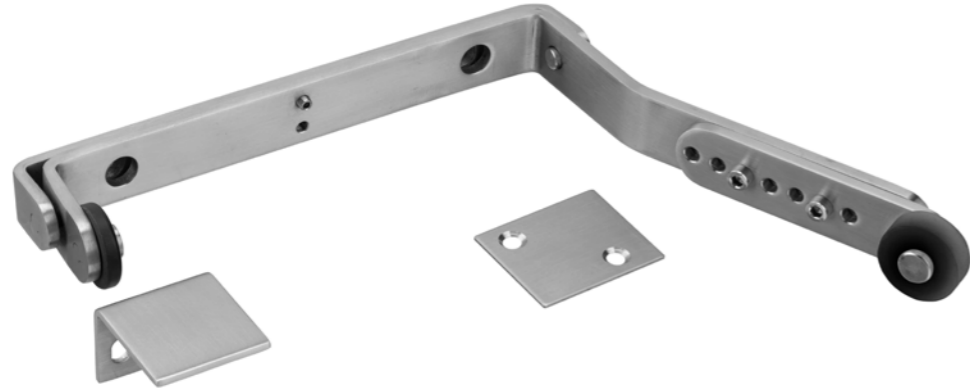

Door coordinator Stainless steel

IN.21.504 / Un.

Seleto de fecho para conjuntos de duas folhas.

Door coordinators for double-leaf door sets.

A folha de porta ativa é impedida de fechar pelo seletor de fecho. A folha passiva fecha primeiro e o seletor liberta a folha ativa de modo que ambas as folhas da porta sejam fechadas na ordem correta.

The active door-leaf is prevented from closing by the lock-head of the coordinator. The passive door-leaf closes first and the coordinator releases the active door-leaf so both door-leaves are closed in the correct order.

Folha da porta ativa: a folha da porta normalmente utilizada para a passagem.
Folha de porta passiva: a folha de porta normalmente não é utilizada para passagem.

Active door-leaf: the door-leaf normally used for passage. Passive door-leaf: the door-leaf normally not used for passage.

Para ser instalado sobre o aro, adequada para portas esquerdas ou direitas.

To be installed over the frame, suitable for left or right-handed doors.

Selector de cierre para conjuntos de puertas de dos hojas.

El selector de cierre impide el cierre de la hoja activa. La hoja pasiva se cierra primero y el selector libera la hoja activa para que ambas hojas se cierren en el orden correcto.

Hoja activa de la puerta: la hoja de la puerta que se utiliza normalmente para el paso. Hoja de la puerta pasiva: la hoja de la puerta que no se utiliza normalmente para el paso.

Para instalar sobre el marco, apto para puertas izquierdas o derechas.

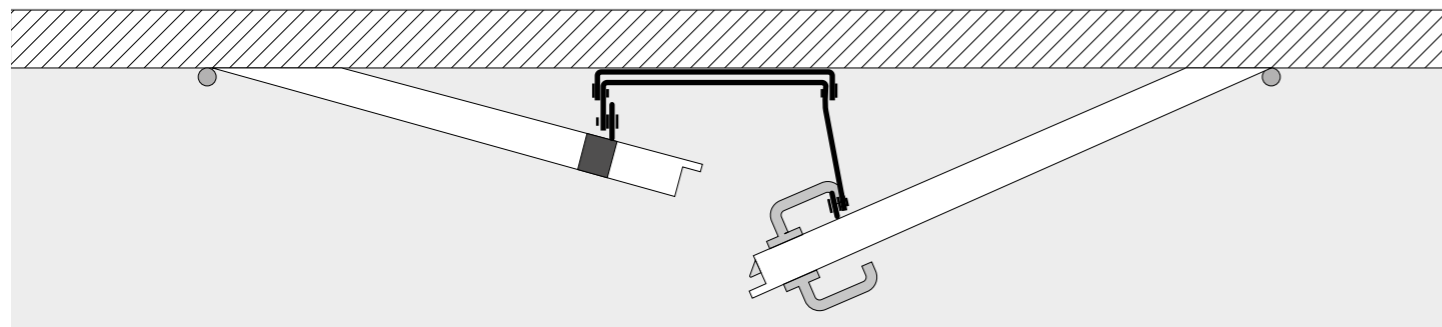

Mortise automatic bolt for passive door

IN.17.622 / Un.

Fecho de embutir automático. Aplicável na porta passiva, quando a porta ativa fecha este sistema é ativado e bloqueia. Pode ser instalado na parte superior ou inferior da porta / Automatic deadbolt. Applicable on the passive door, when the active door closes this system is activated and locks. It can be installed on the top or on the bottom of the door / Cerradura automática de embutir. Aplicable en la puerta pasiva, cuando la puerta activa se cierra este sistema se activa y se bloquea. Puede instalarse en la parte superior o en la inferior de la puerta.

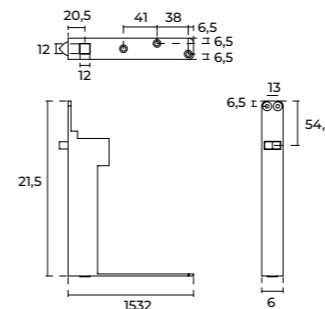
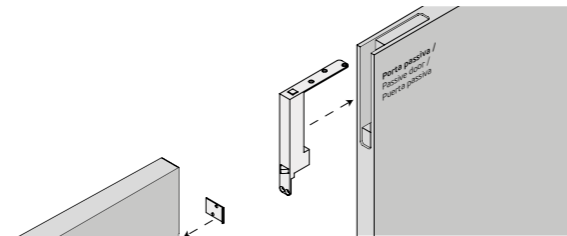

Automatic / Manual bolt for passive door

IN.17.622.L / Un.

Fecho de embutir automático ou manual. Aplicável na porta passiva, quando a porta ativa fecha este sistema é ativado e bloqueia. Pode ser instalado na parte superior ou inferior da porta / Automatic or manual deadbolt. Applicable on the passive door, when the active door closes this system is activated and locks. It can be installed on the top or on the bottom of the door / Cerradura automática o manual de embutir. Aplicable en la puerta pasiva, cuando la puerta activa se cierra este sistema se activa y se bloquea. Puede instalarse en la parte superior o en la inferior de la puerta.

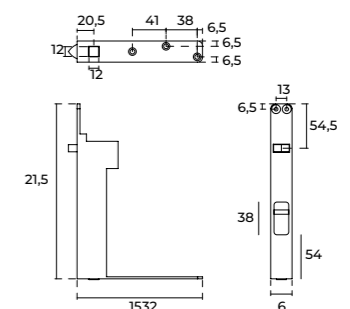
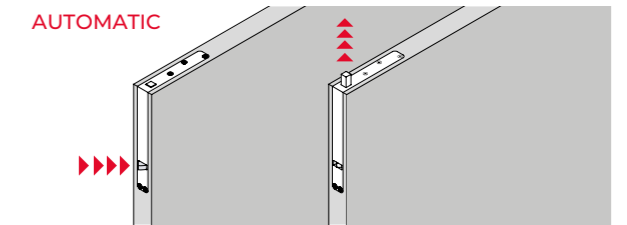

DOOR CLOSERS



new

Smooth latch Concealed

ML.21.120 / Set



Mecanismo de fecho suave e automático para portas de 30 a 50kg. Para portas de batente ou dupla ação. Para montagem oculta.

Activador com ajuste 3D /

Soft and self closing mechanism for doors from 30 to 50kg. For single and double action doors. For concealed mounting. Catcher with 3D adjustment /

Mecanismo de cierre suave y automático para puertas de 30 a 50kg. Para puertas de simple y doble acción. Para montaje oculto. Ativador con ajuste 3D.

Plástico / Plastic

RAL 9005 (preto / black / negro)

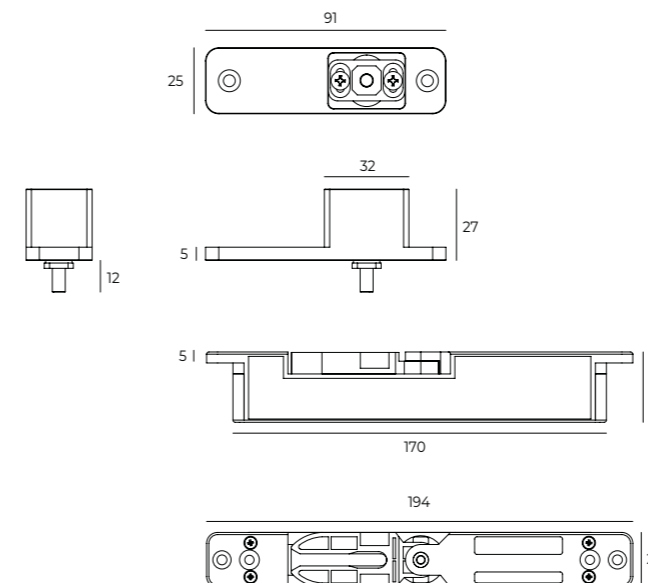



new

Smooth latch Overlap

ML.21.121 / Set



Mecanismo de fecho suave e automático para portas de 30 a 50kg. Para portas de batente. Para montagem sobreposta.
Activador com ajuste 3D /
Soft and self closing mechanism for doors from 30 to 50kg. For single action doors. For rim mounting.
Catcher with 3D adjustment /
Mecanismo de cierre suave y automático para puertas de 30 a 50kg. Para puertas de acción simple. Para montaje de sobreponer. Ativador con ajuste 3D /

Plástico / Plastic
RAL 9005 (preto / black / negro)

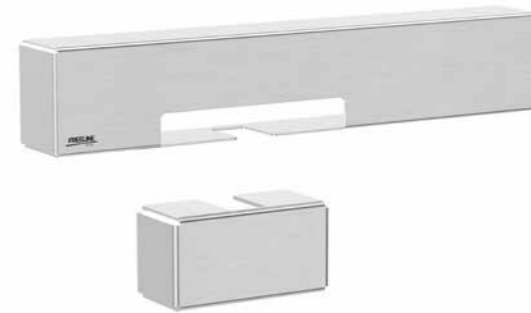
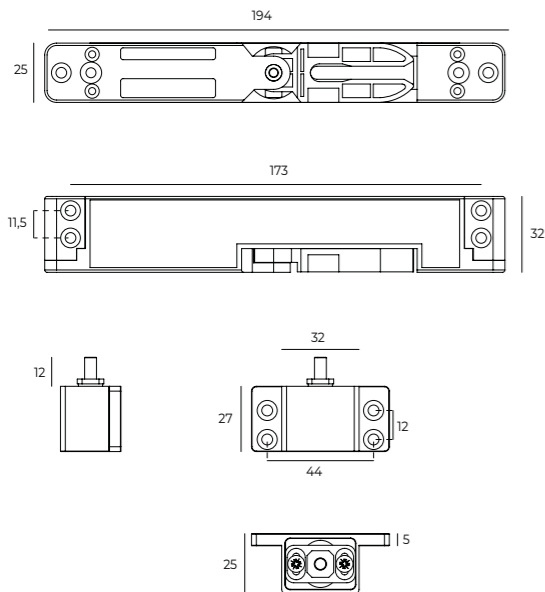

ML.21.122.D

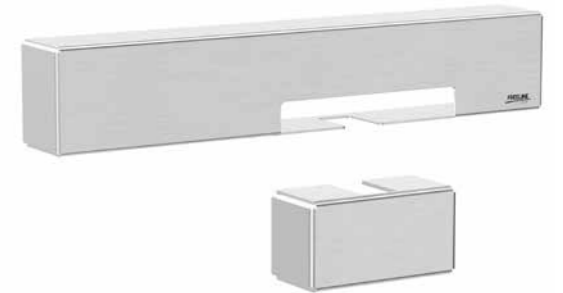

ML.21.122.E

new

Smooth latch Covers

ML.21.122.D / Set
(Direita / Right / Derecha)
ML.21.122.E / Set
(Esquerda / Left / Izquierda)



Coberturas para ML.21.121 em aço inox /
Covers in stainless steel for ML.21.121 /
Coberturas para ML.21.121 en acero inoxidable /

Aço inoxidável /
Stainless steel / Acero inoxidable

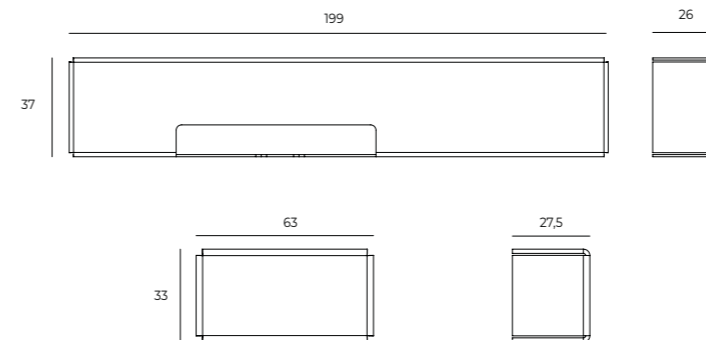



Overhead door closer

Standard arm 2-4

ML.21.550 (SILVER RAL 9006) / Un.
ML.21.550.B (BLACK RAL 9005) / Un.
ML.21.550.W (WHITE RAL 9016) / Un.

Mola de porta aérea hidráulica de sobrepôr com braço standard sem paragem / Hydraulic overhead door closer with standard arm without retaining / Cierra puertas hidráulico de sobreponer con brazo estandard sin retención.

- **Força ajustável por posição /**
Adjustable power by position / Fuerza ajustable por posición: 2-4
- **Largura máxima de porta /**
Maximum door width / Ancho máximo de puerta: 1000mm
- **Peso máximo de porta /**
Maximum door weight / Peso máximo de puerta: 60kg;
- **Mecanismo cremalheira e pinhão /**
Rack and pinion mechanism / Mecanismo de piñon y cremallera
- **Velocidade de fecho ajustável por válvula /**
Closing speed adjustable by valve /
Velocidad de cierre ajustable por válvula.
- **Velocidade de fecho final ajustável por válvula /**
Latching speed adjustable by valve /
Velocidad de golpe final ajustable por válvula.
- **Ângulo de abertura 180° /**
Opening angle 180° / Ángulo de apertura 180°
- **Mola reversível /**
Reversible door closer / Cierra puertas reversible



ML.21.550



ML.21.550.B



ML.21.550.W

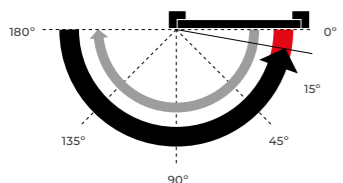

- **Abertura /**
Opening /
Apertura.
- **Velocidade de fecho**
Closing speed /
Velocidade de freno.
- **Velocidade do fecho final**
Final closing speed /
Velocidade de golpe final.

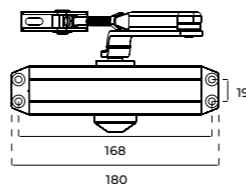
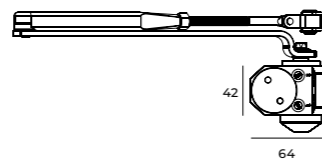

Overhead door closer

Standard arm 2-4 with cover

ML.21.550 (SILVER RAL 9006) / Un.
ML.21.550.B (BLACK RAL 9005) / Un.
ML.21.550.W (WHITE RAL 9016) / Un.

Mola de porta aérea hidráulica de sobrepôr com braço standard sem paragem / Hydraulic overhead door closer with standard arm without retaining / Cierra puertas hidráulico de sobreponer con brazo estandard sin retención.

- **Força ajustável por posição /**
Adjustable power by position / Fuerza ajustable por posición: 2-4
- **Largura máxima de porta /**
Maximum door width / Ancho máximo de puerta: 1000mm
- **Peso máximo de porta /**
Maximum door weight / Peso máximo de puerta: 60kg;
- **Mecanismo cremalheira e pinhão /**
Rack and pinion mechanism / Mecanismo de piñon y cremallera
- **Velocidade de fecho ajustável por válvula /**
Closing speed adjustable by valve /
Velocidad de cierre ajustable por válvula.
- **Velocidade de fecho final ajustável por válvula /**
Latching speed adjustable by valve /
Velocidad de golpe final ajustable por válvula.
- **Ângulo de abertura 180° /**
Opening angle 180° / Ángulo de apertura 180°
- **Mola reversível /**
Reversible door closer / Cierra puertas reversible



21.205 (SILVER RAL 9006) / Un.
21.205.B (BLACK RAL 9005) / Un.
21.205.W (WHITE RAL 9016) / Un.

Cobertura para mola /
Cover for door closer / Cobertura para cierra puertas.



ML.21.550 + 21.205



ML.21.550.B + 21.205.B



ML.21.550.W + 21.205.W

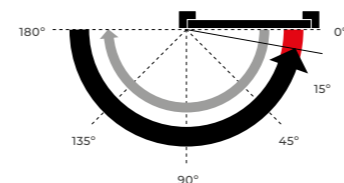

- **Abertura /**
Opening /
Apertura.
- **Velocidade de fecho**
Closing speed /
Velocidade de freno.
- **Velocidade do fecho final**
Final closing speed /
Velocidade de golpe final.

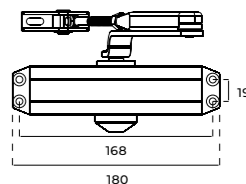
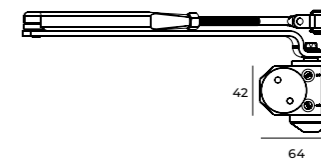



Overhead door closer

Sliding arm power 3

ML.21.550.BA (SILVER RAL 9006) / Un.
ML.21.550.BA.B (BLACK RAL 9005) / Un.
ML.21.550.BA.W (WHITE RAL 9016) / Un.

Mola de porta aérea hidráulica de sobrepôr com braço anti vandalismo / Hydraulic overhead door closer with sliding arm / Cierra puertas hidráulico de sobreponer con brazo anti vandalismo.

- **Força fixa:** / Fixed power / Fuerza fija: **3**
- **Largura máxima de porta:** / Maximum door width / Ancho máximo de puerta: **1000mm**
- **Peso máximo de porta:** / Maximum door weight / Peso máximo de puerta: **60kg;**
- **Mecanismo cremalheira e pinhão:** / Rack and pinion mechanism / Mecanismo de piñon y cremallera
- **Velocidade de fecho ajustável por válvula:** / Closing speed adjustable by valve / Velocidad de cierre ajustable por válvula.
- **Velocidade de fecho final ajustável por válvula:** / Latching speed adjustable by valve / Velocidad de golpe final ajustable por válvula.
- **Ângulo de abertura 180°:** / Opening angle 180° / Ángulo de apertura 180°
- **Mola reversível:** / Reversible door closer / Cierra puertas reversible



ML.21.550.BA

ML.21.550.BA.B

ML.21.550.BA.W

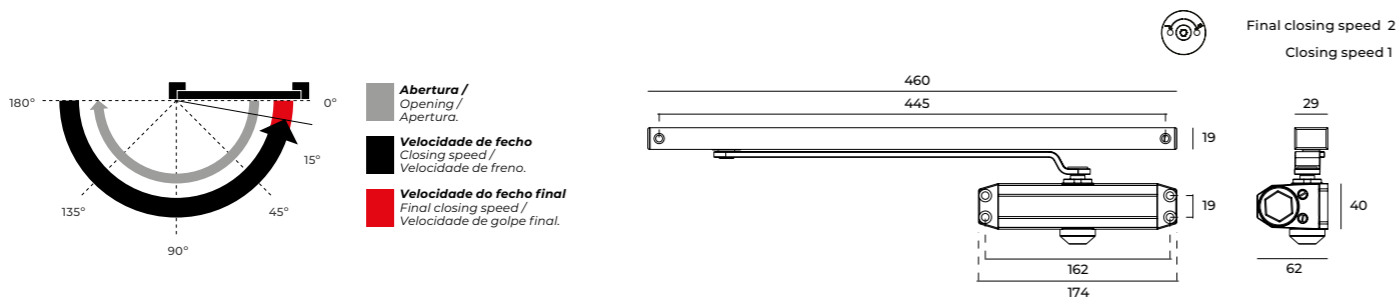

Overhead door closer

Sliding arm power 3 with cover

ML.21.550.BA (SILVER RAL 9006) / Un.
ML.21.550.BA.B (BLACK RAL 9005) / Un.
ML.21.550.BA.W (WHITE RAL 9016) / Un.

Mola de porta aérea hidráulica de sobrepôr com braço anti vandalismo / Hydraulic overhead door closer with sliding arm / Cierra puertas hidráulico de sobreponer con brazo anti vandalismo.

21.205 (SILVER RAL 9006) / Un.
21.205.B (BLACK RAL 9005) / Un.
21.205.W (WHITE RAL 9016) / Un.

Cobertura para mola / Cover for door closer / Cobertura para cierra puertas.

- **Força fixa:** / Fixed power / Fuerza fija: **3**
- **Largura máxima de porta:** / Maximum door width / Ancho máximo de puerta: **1000mm**
- **Peso máximo de porta:** / Maximum door weight / Peso máximo de puerta: **60kg;**
- **Mecanismo cremalheira e pinhão:** / Rack and pinion mechanism / Mecanismo de piñon y cremallera
- **Velocidade de fecho ajustável por válvula:** / Closing speed adjustable by valve / Velocidad de cierre ajustable por válvula.
- **Velocidade de fecho final ajustável por válvula:** / Latching speed adjustable by valve / Velocidad de golpe final ajustable por válvula.
- **Ângulo de abertura 180°:** / Opening angle 180° / Ángulo de apertura 180°
- **Mola reversível:** / Reversible door closer / Cierra puertas reversible



ML.21.550.BA + 21.205

ML.21.550.BA.B + 21.205.B

ML.21.550.BA.W + 21.205.W

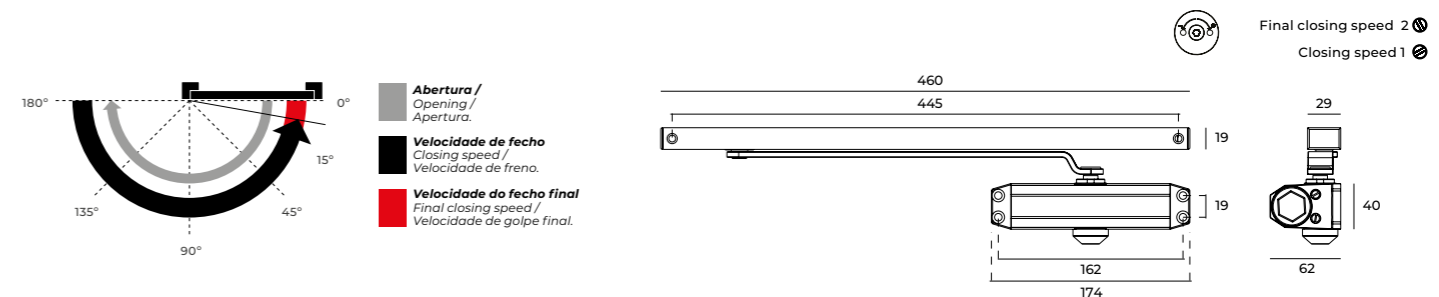



Concealed door closer

Sliding arm - RAL 9006

ML.21.800 / Un.
(SILVER RAL 9006)

Mola de porta aérea hidráulica de embutir
para portas de batente /
Concealed hydraulic overhead
door closer to single action /
Cierra puertas hidráulico de embutir
para puertas de batiente.

- Braço anti-vandalismo / Sliding arm / Brazo antivandalismo
- Força fixa: | Fixed power / Fuerza fija: 3
- Largura máxima de porta /
Maximum door width / Ancho máximo de puerta: 950mm
- Peso máximo de porta /
Maximum door weight / Peso máximo de puerta: 65kg;
- Mecanismo cremalheira e pinhão /
Rack and pinion mechanism / Mecanismo de piñon y cremallera
- Velocidade de fecho ajustável por válvula /
Closing speed adjustable by valve /
Velocidad de cierre ajustable por válvula.
- Velocidade de fecho final ajustável por válvula /
Latching speed adjustable by valve /
Velocidad de golpe final ajustable por válvula.
- Ângulo de abertura /
Opening angle / Ángulo de apertura 120°
- Mola reversível / Reversible door closer / Cierra puertas reversible

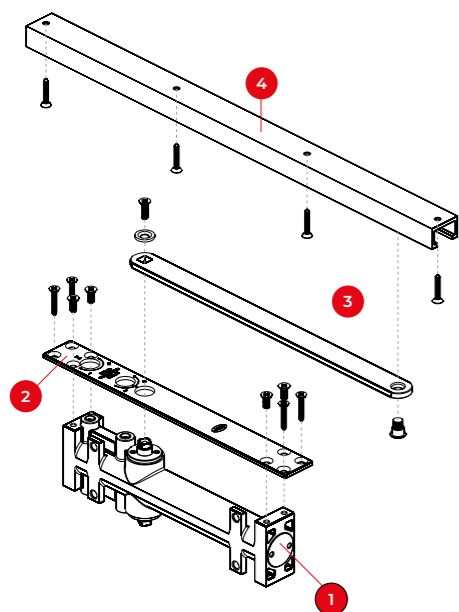

- 1 Corpo /
Body /
Cuerpo /
- 2 Barra de fixação /
Fixing plate /
Barra de sujeción /
- 3 Braço /
Arm /
Brazo /
- 4 Calha (RAL 9006) /
Track 8Ral 9006 /
Cubierta (RAL 9006) /

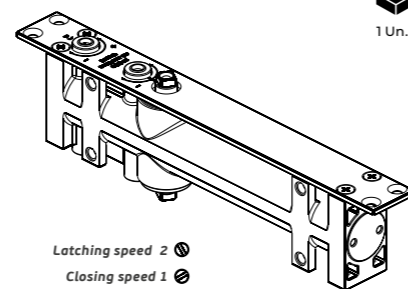

Latching speed 2
Closing speed 1

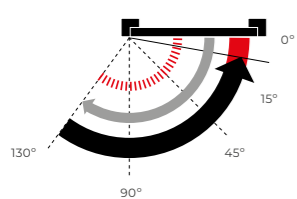

- Abertura /
Opening /
Apertura.
- Velocidade de fecho
Closing speed /
Velocidade de freno.
- Velocidade do fecho final
Final closing speed /
Velocidade de golpe final.
- Retenção na abertura (amovível) /
Hold open system (removable) /
Retención en la apertura (extraíble).

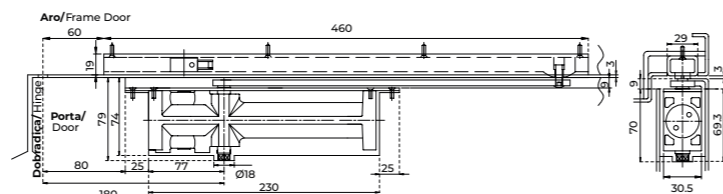



new

Floor door closer Power 3



21.2265 /Un.

Mola de pavimento para portas de batente ou vai-vém aplicável em portas de madeira, metálicas ou de vidro, com paragem a 90° /
Floor closer for single action doors or double action doors applicable to wooden, metal or glass doors with a hold open position at 90° /
Cierra puertas de suelo para puertas de batiente o doble acción, aplicable a puertas de madera, metálicas o de cristal con retención a 90°.



1 Un. 4 Un.

- Para portas com peso até 100kg;
- Velocidade ajustável por válvula hidráulicas desde os 130° aos 0°;
- Duas válvulas de ajuste para controlo independente da velocidade desde 130°-15° a 15°-0°;

- For doors with weight up to 100kg;
- Adjustable speed changeable through a hydraulic valve since 130° to 0°;
- Two independent valves of adjustment of latching speed controlling since 130°-15° to 15°-0°;

- Para puertas con peso hasta 100kg.
- Velocidad ajustable por válvula hidráulica desde 130° a 0°;
- Dos válvulas independientes para ajuste del cierre que controla la velocidad desde los 130°-15° hasta 15°-0°;

Com quadra 17x17mm fixa /
With 17x17mm fixed spindle /
Con cuadradillo 17x17mm fijo.

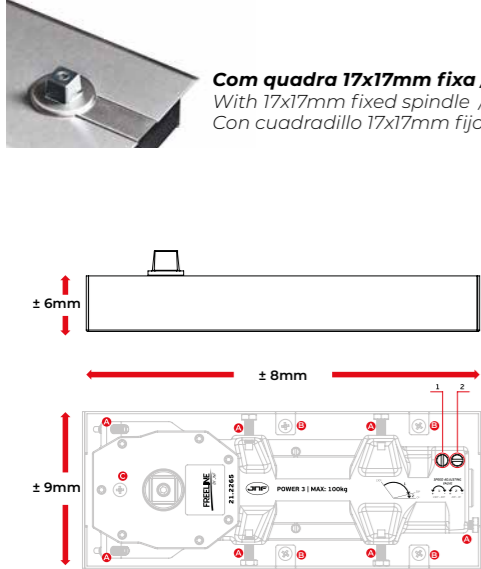

A Parafusos de ajuste de posição /
Position adjusting screws /
Tornillos de ajuste de posición.

B Parafusos de fixação da cobertura /
Cover fixing screws /
Tornillos de fijación de la cubierta.

C Parafuso de fixação de remate /
Dust proof cover screw /
Tornillo de fijación de cubierta antipolvo.



1 Velocidade de fecho final /
Final closing speed /
Velocidade de golpe final.

2 Velocidade de fecho /
Closing speed /
Velocidade de freno.

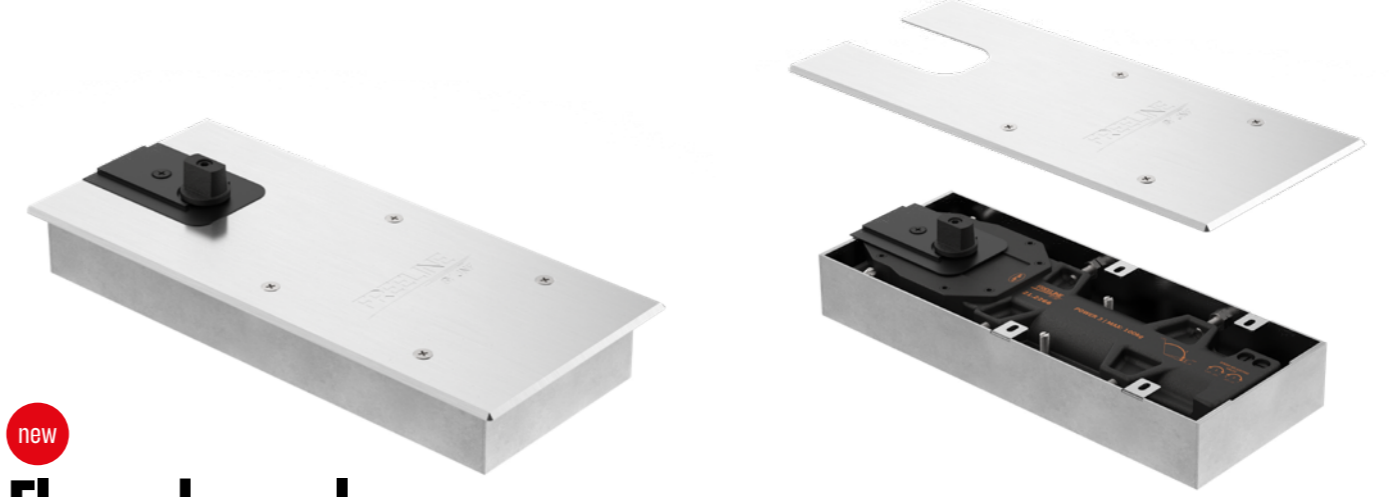

new

Floor door closer Power 3



21.2266 /Un.

Mola de pavimento para portas de batente ou vai-vém aplicável em portas de madeira, metálicas ou de vidro, com paragem a 90° /
Floor closer for single action doors or double action doors applicable to wooden, metal or glass doors with a hold open position at 90° /
Cierra puertas de suelo para puertas de batiente o doble acción, aplicable a puertas de madera, metálicas o de cristal con retención a 90°.



1 Un. 4 Un.

- Para portas com peso até 100kg;
- Velocidade ajustável por válvula hidráulicas desde os 130° aos 0°;
- Duas válvulas de ajuste para controlo independente da velocidade desde 130°-15° a 15°-0°;

- For doors with weight up to 100kg;
- Adjustable speed changeable through a hydraulic valve since 130° to 0°;
- Two independent valves of adjustment of latching speed controlling since 130°-15° to 15°-0°;

- Para puertas con peso hasta 100kg.
- Velocidad ajustable por válvula hidráulica desde 130° a 0°;
- Dos válvulas independientes para ajuste del cierre que controla la velocidad desde los 130°-15° hasta 15°-0°;

Com quadra 22x11,6mm fixa /
With 22x11,6mm fixed spindle /
Con cuadradillo 22x11,6mm fijo.

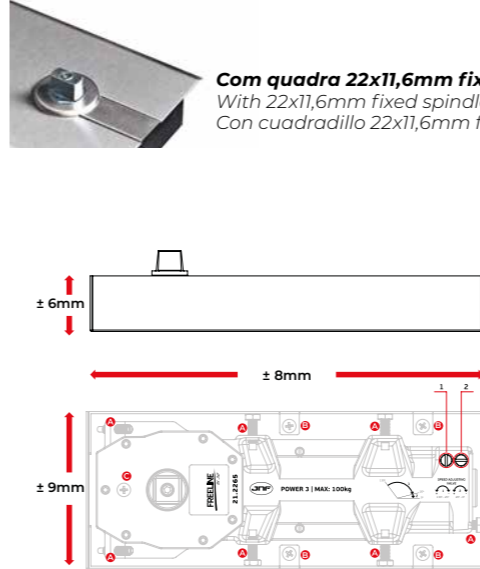

A Parafusos de ajuste de posição /
Position adjusting screws /
Tornillos de ajuste de posición.

B Parafusos de fixação da cobertura /
Cover fixing screws /
Tornillos de fijación de la cubierta.

C Parafuso de fixação de remate /
Dust proof cover screw /
Tornillo de fijación de cubierta antipolvo.



1 Velocidade de fecho final /
Final closing speed /
Velocidade de golpe final.

2 Velocidade de fecho /
Closing speed /
Velocidade de freno.



Floor door closer Power 3



21.2207 / Un.

Mola de pavimento para portas de batente ou vai-vém aplicável em portas de madeira, metálicas ou de vidro, com paragem a 90° /
Floor closer for single action doors or double action doors applicable to wooden, metal or glass doors with a hold open position at 90° /
Cierra puertas de suelo para puertas de batiente o doble acción, aplicable a puertas de madera, metálicas o de cristal con retención a 90°.



Com quadra 17x17mm fixa /
With 17x17mm fixed spindle /
Con cuadradillo 17x17mm fijo.

- Para portas com peso até 80kg;
- Velocidade ajustável por válvula hidráulicas desde os 130° aos 0°;
- Duas válvulas de ajuste para controlo independente da velocidade desde 130°-15° a 15°-0°;
- For doors with weight up to 80kg;
- Adjustable speed changeable through a hydraulic valve since 130° to 0°;
- Two independent valves of adjustment of latching speed controlling since 130°-15° to 15°-0°;
- Para puertas con peso hasta 80kg.
- Velocidad ajustable por válvula hidráulica desde 130° a 0°;
- Dos válvulas independientes para ajuste del cierre que controla la velocidad desde los 130°-15° hasta 15°-0°;

Final closing speed 2 Ⓢ
Closing speed 1 Ⓢ

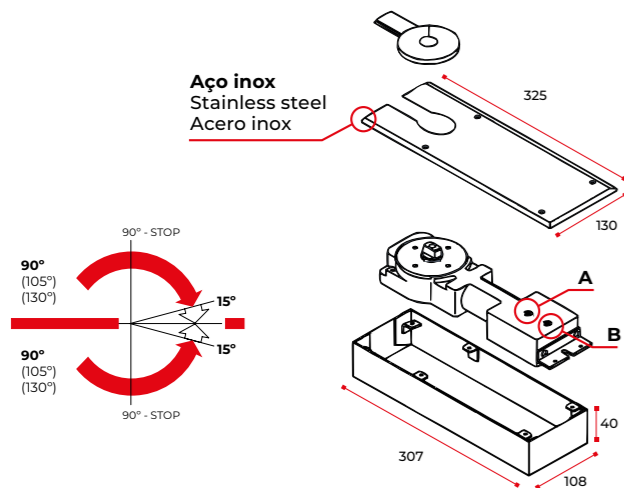
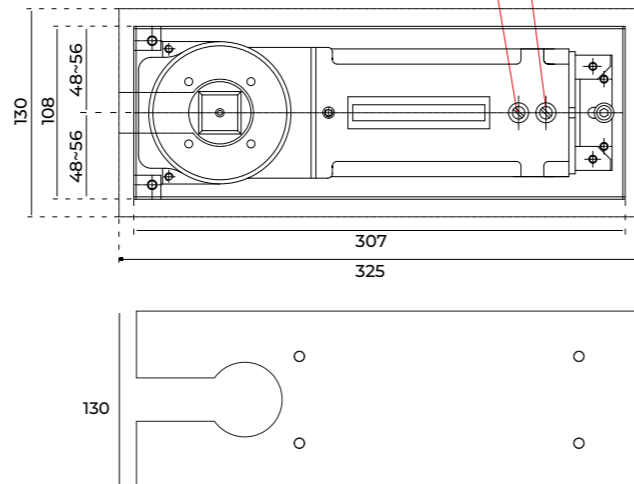

Pivot Set Double action

21.2200.WQ / Set



Pivot para portas de dupla acção.
Aplicar com quadra 21.001.Q /
Double action door pivot.
To use with spindle 21.001.Q /
Pivote para puertas de doble acción.
Aplicar con el cuadradillo 21.001.Q.

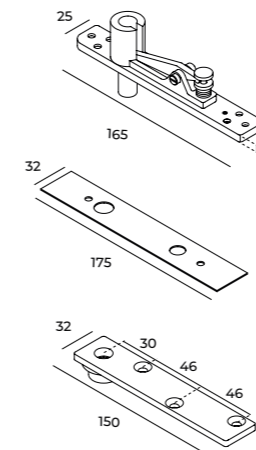

21.2200.D

21.2200.E



Pivot Set Single action

21.2200.D / Set
(Direito / Right / Derecho)
21.2200.E / Set
(Esquerdo / Left / Izquierdo)



Braço de batente para mola de pavimento /
Stopper arm for floor closer /
Brazo de tope para cierra puertas de suelo.

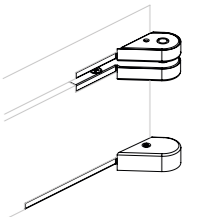
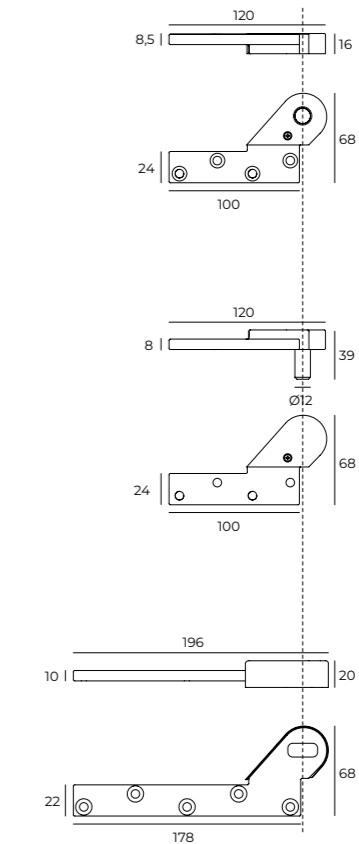

DROP DOWN SEALS

Os veda-porta automáticos eliminam a folga existente entre a porta e o pavimento. Esse espaço é preenchido quando a porta é fechada através dum vedante de borracha macia que desliza no sentido do solo. O movimento impulsionado por um mecanismo de pistão que toca no aro do lado das dobradiças. São um acessório que confere elevado grau de conforto numa habitação, já que eliminam correntes de ar, aumentam o isolamento térmico evitam a passagem de poeira e o ruído é eficazmente reduzido. A dimensão destes veda-porta varia desde 730 até 1130mm, pode ser ajustado por corte até 150mm.

Automatic drop-down seals eliminate the gap between the door and the floor. This gap is filled when the door is closed by a soft rubber seal sliding towards the floor. The movement is driven by a piston mechanism that touches the frame on the hinge side. They are an accessory that provides a high degree of comfort in a home, as they eliminate draughts, increase thermal insulation, prevent the passage of dust and effectively reduce noise. The dimensions of these door seals range from 730 to 1130mm and can be cut to 150mm.

Los veda puertas automáticas eliminan el hueco entre la puerta y el suelo. Este hueco se rellena al cerrar la puerta con una junta de goma blanda que se desliza hacia el suelo. El movimiento se acciona mediante un mecanismo de pistón que toca el marco por el lado de la bisagra. Son un accesorio que proporciona un alto grado de confort en una vivienda, ya que eliminan las corrientes de aire, aumentan el aislamiento térmico, impiden el paso del polvo y reducen eficazmente el ruido. Las dimensiones de estos cierres de puerta van de 730 a 1130mm y pueden cortarse hasta 150mm.



44 dB Rw

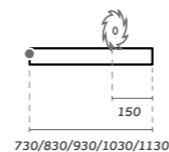

730/830/930/1030/1130

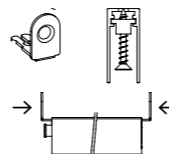

Drop down seal 13x28 Concealed / automatic

- IN.06.005.1330 / Un.
- IN.06.005.1230 / Un.
- IN.06.005.1130 / Un.
- IN.06.005.1030 / Un.
- IN.06.005.930 / Un.
- IN.06.005.830 / Un.
- IN.06.005.730 / Un.
- IN.06.005.630 / Un.
- IN.06.005.530 / Un.
- IN.06.005.430 / Un.



Veda portas automático de encastrar com fixação lateral e inferior. Activador de metal articulado com tampa de nylon, ajustável com uma chave Allen de 3mm. Selante termoplástico auto-extinguível coextrudido (rígido + macio). Pode ser cortado. Outras medidas sob consulta /
Concealed drop seal with side and bottom fixing. Self-directing articulated metal plunger with nylon cap, adjustable with a 3mm Allen wrench. Co-extruded self-extinguishing thermoplastic seal (rigid + soft). Can be cut. Other measures on request /
Juntas automática de encastrar con fijación lateral y inferior. Pulsador autodireccional articulado, metálico con capuchón de nylon regulable con llave hexagonal de 3mm. Junta de material termoplástico ignífugo coextrudido (rígido + blando). Puede ser cortado. Otras medidas por consulta.

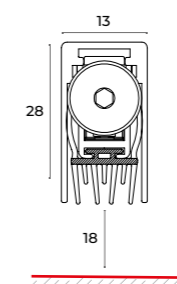
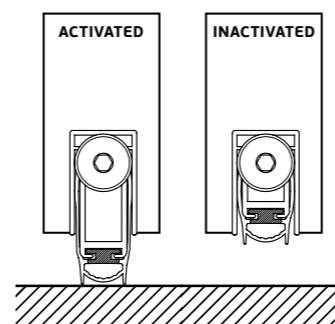

37 dB Rw

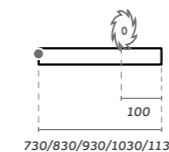

730/830/930/1030/1130

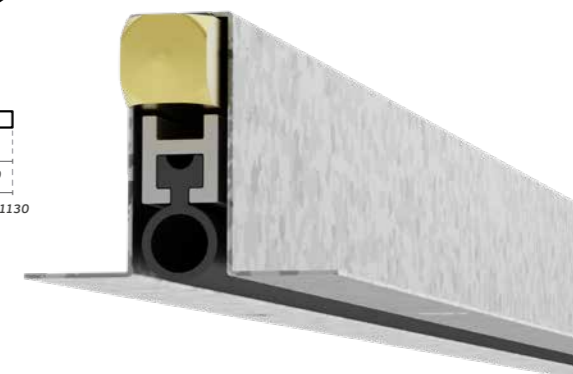

Drop down seal 12x28 Concealed / Flaps

- STENC.103 / Un.
- STENC.093 / Un.
- STENC.083 / Un.
- STENC.073 / Un.



A fixação do veda portas automático com parafusos é feita nas abas laterais do perfil de ferro. Activador de metal é ajustável. Pode ser cortado /
The fixing way of the automatic seals with screws is made on the lateral wings of the steel profile. Metal plunger can be adjustable. Can be cut /
La fijación de la junta automática con tornillos es hecha en las aletas externas del perfil. Pulsador metálico regulable. Puede ser cortado.

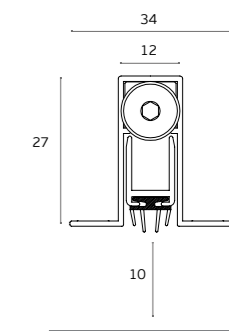
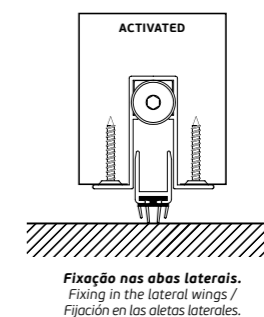

PAG.	CAP / DES.	PAG.	CAP / DES.
342	8.1 FECHADURAS DE SEGURANÇA / SECURITY LOCKS / CERRADURAS DE SEGURIDAD.	386	8.10 FECHADURAS PARA PORTAS DE CORRER / LOCKS FOR SLIDING DOORS / CERRADURAS PARA PUERTAS CORREDERAS.
354	8.2 FECHADURA DE SOBREPOR / RIM LOCK / CERRADURA DE SOBREPONER.	392	8.11 FECHADURAS AUXILIARES / AUXILIARY LOCKS / CERRADURAS AUXILIARES.
362	8.3 FECHADURAS MAGNÉTICAS / MAGNETIC LOCK / CERRADURAS MAGNETICAS.	398	8.12 CILINDRO DE SEGURANÇA / SECURITY CYLINDER / CILINDRO DE SEGURIDAD.
368	8.4 SÉRIE 790 / 790 SERIES / SERIE 790.	402	8.13 CILINDRO STANDARD / STANDARD CYLINDER / CILINDRO ESTANDAR.
370	8.5 SÉRIE 820 COM CAIXA UNIFICADA / 820 SERIES WITH UNIFIED CASE / SERIE 820 CON CAJA UNIFICADA.	406	8.14 CILINDRO BÁSICO BASIC CYLINDER / CILINDRO BASICO
376	8.6 FECHADURAS PARA INDUSTRIA / INDUSTRY LOCKS / CERRADURAS PARA INDUSTRIA.	408	8.15 FECHADURA ELECTROMAGNÉTICA / ELECTROMAGNETIC LOCK / CERRADURA ELECTROMAGNETICA.
378	8.7 SÉRIE 720 720 SERIES / SERIE 720.	409	8.16 FECHADURA ELÉCTRICA DROP PIN / DROP PIN LOCK / CERRADURA ELECTRICA DROP PIN
380	8.8 SÉRIE 700 / 700 SERIES / SERIE 700.	410	8.17 TESTA ELECTRICA / ELECTRIC STRIKE / CERRADERO ELECTRICO.
382	8.9 FECHADURA DE EMBUTIR / MORTISE DOOR LOCK / CERRADURA DE EMBUTIR.	411	8.18 FONTE DE ALIMENTAÇÃO / POWER SUPPLY / FUENTE DE ALIMENTACION.

	Fechadura para cilindro europeu / Lock for european cylinder / Cerradura para cilindro europeo.		Marcação Corta fogo / Fire proof certified / Certificada corta fuego.		Sem funcionamento pelo exterior / Without access from outside / Sin funcionamiento por el exterior.
	Fechadura de chave normal / Lock for normal key / Cerradura de llave normal.		SECURITY DOOR		Barra horizontal / Horizontal panic device / Barra horizontal.
	WC Fechadura para casa de banho / Bathroom lock / Cerradura para baño.		TIMBER DOOR		Aplicável com fechadura de embutir / Applicable with mortice lock / Aplicable con cerradura de embutir.
	PASSAGEM Fechadura de passagem / Passage type lock / Cerradura de paso.		Número de chaves fornecidas / Number of supplied keys / Numero de llaves suministradas.		Fechadura para porta de correr / Lock for sliding door / Cerradura para puerta corredera.
	GRADE 1 Fechadura para uso ligeiro / Lock for light use / Cerradura para uso ligero.		Cantos rectos ou arredondos / Straight or rounded corners / Cantos rectos o redondos.		Número de combinações de chave normal / Number of combinations for normal key / Numero de combinaciones de llave de borjas.
	GRADE 2 Fechadura para uso médio / Lock for medium use Cerradura para uso mediano.		Fechadura para porta anti-pânico / Antipanic door lock / Cerradura para puerta antipánico.		Fechadura de segurança / Security lock / Cerradura de seguridad.
	GRADE 3 Fechadura para uso intensivo / Lock for intensive use Cerradura para uso intensivo.		Fechadura com trinco standard / Lock with standard latch / Cerradura con picaporte standard.		Marcação CE / CE Marking / Marcado CE.
	Fechadura com trinco reversível / Lock with reversible latch / Cerradura con picaporte reversible.		Espessura da porta / Thickness of the door / Espesor de la puerta.		Kit intumescente disponível / Intumescent kit available / Kit intumescente disponibles.
	Distância entre eixos / Distance between holes Distancia entre ejes.		Barra horizontal com fecho vertical / Horizontal panic device with upper and lower latch / Barra horizontal con cierra vertical.		Fechadura com trinco lateral silencioso / Silent side locking latch / Picaporte lateral silencioso
	Trinco magnético Magnetic latch / Picaporte magnetica.		Barra anti-pânico reversível / Antipanic reversible Lock / Cerradura Antipánico reversible.		Puxador fixo no exterior / Fixed Knob from outside Pomo Fijo por el exterior.
	Fechadura para porta anti-pânico / Lock for antipanic door / Cerradura para puerta antipánico.		Número de chaves por cilindro / Number of keys by cylinder / Numero de llaves.		Por chave pelo exterior / With key from outside / Por llave por el exterior.
	Marcação CE / CE Marking / Marcado CE.		Permite planos de mestragem / Allows plans of master key system / Capacidad de crear planos de amaestramiento.		Distância da testa à entrada / Distance between strike plate and the holes / Distancia entre frente y ejes.
	EN 1125 Certificadas segundo a Norma Europeia / Certified accordingly to the European Norm / Certificadas segundo la Norma Europea.		Puxador rotativo no exterior / Lever handle from outside Manilla por el exterior.		Fechadura para parafusos passantes / Lock with passing screw hole Cerradura con agujeros para tornillos pasantes.
	Quadra normal / Normal spindle / Nueca normal.		Quadra com mola compensadora para eliminar folga entre o puxador e a fechadura / Spindle with internal spring to avoid any gap between the handle and the lock / Nueca con muelle interior para eliminar la holgura entre la manilla e la cerradura.		

9

FERRAGENS PARA CABINES SANITÁRIAS **SANITARY BOOTH HARDWARE** HERRAJES PARA CABINAS SANITARIAS.

9.1
**FERRAGENS PARA
CABINES SANITÁRIAS /
SANITARY BOOTH HARDWARE /
HERRAJES PARA CABINAS
SANITARIAS.**

9.2
**AUXÍLIOS TÉCNICOS PARA
PESSOAS COM MOBILIDADE
CONDICIONADA /
TECHNICAL AID FOR PEOPLE WITH
CONDITIONED MOBILITY /
AYUDAS TÉCNICAS PARA
PERSONAS CON MOVILIDAD
ACONDICIONADA.**

9.3
**FERRAGENS PARA
CABINES EM HPL /
HPL PARTITIONS HARDWARE /
HERRAJES PARA CABINAS EN HPL.**





Wall dispenser L for paper towels

IN.60.556.L / Un.

Dispensador de parede com fechadura para toalhas de papel / Wall paper dispenser with lock for paper towels / Dispensador de pared con cerradura para toallas de papel.



EN 1.4301 - AISI 304
Satinado / Satin

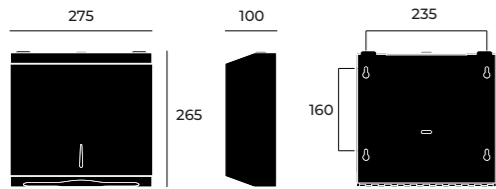

Wall dispenser XL for paper towels

IN.60.555 / Un.

Dispensador de parede com fechadura para toalhas de papel / Wall paper dispenser with lock for paper towels / Dispensador de pared con cerradura para toallas de papel.



EN 1.4301 - AISI 304
Satinado / Satin

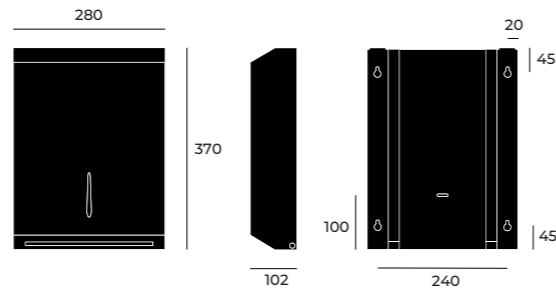

JUMBO wall dispenser for paper roll

IN.60.489 / Un.

Dispensador de parede JUMBO com fechadura para rolo de papel higiênico industrial / JUMBO Wall dispenser with lock for industrial paper roll. / Dispensador de pared JUMBO con cerradura para rollos de papel industrial.



EN 1.4301 - AISI 304
Satinado / Satin

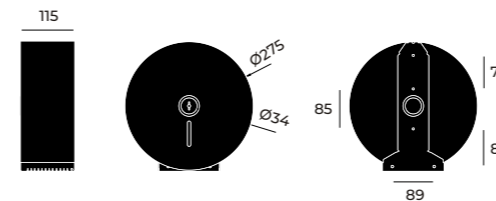

Hand dryer automatic 1800W

IN.60.546 / Un.

Secador de mãos automático/
Automatic hand dryer/
Secador de manos automático.



EN 1.4301 - AISI 304
Satinado / Satin



Tipo motor / motor type	1800w-2680rpm
Potência motor / motor power	60w
Nível ruído / noise level	67db
Velocidade ar / air speed	12m/s
Sensor / sensor range	50/200mm
isolamento / isolation	class 1

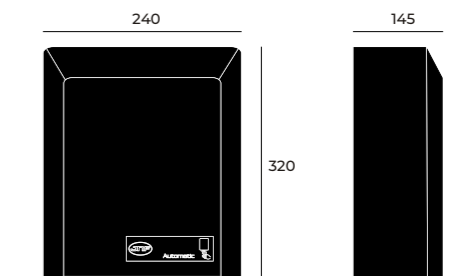



new

Wall dispenser XL for paper towels - Black

IN.60.555.B / Un.

Dispensador de parede com fechadura para toalhas de papel / Wall paper dispenser with lock for paper towels / Dispensador de pared con cerradura para toallas de papel.



EN 1.4301 - AISI 304
RAL 9005 (Preto / Black / Negro)

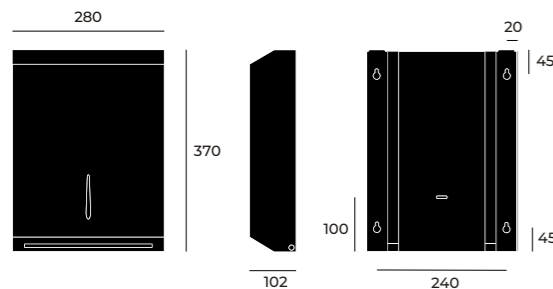

new

JUMBO wall dispenser for paper roll - Black

IN.60.489.B / Un.

Dispensador de parede JUMBO com fechadura para rolo de papel higiênico industrial / JUMBO Wall dispenser with lock for industrial paper roll. / Dispensador de pared JUMBO con cerradura para rollos de papel industrial.



EN 1.4301 - AISI 304
RAL 9005 (Preto / Black / Negro)

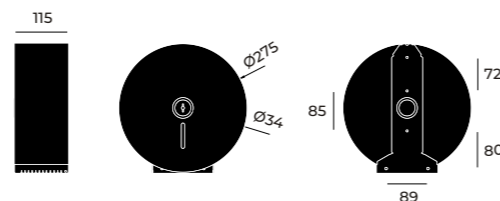

new

Hand dryer automatic 1800W - Black

IN.60.546.B / Un.

Secador de mãos automático/
Automatic hand dryer/
Secador de manos automático.



EN 1.4301 - AISI 304
RAL 9005 (Preto / Black / Negro)

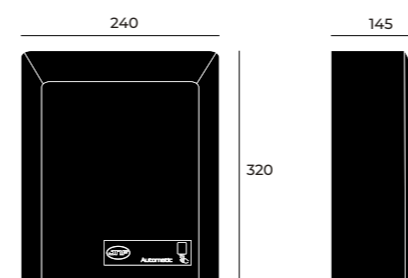

Tipo motor / motor type	1800w-2680rpm
Potência motor / motor power	60w
Nível ruído / noise level	67db
Velocidade ar / air speed	12m/s
Sensor / sensor range	50/200mm
isolamento / isolation	class 1



MÁX.
1L

new

Manual dispenser 1,0 L for liquid soap

IN.60.483.10.B / Un.

*Dispensador de parede para sabão líquido.
Capacidade de 1,0L /
Wall dispenser for liquid soap. Capacity 1,0L /
Dispensador de pared para jabón líquido.
Capacidad 1,0L.*

EN 1.4301 - AISI 304
RAL 9005 (Preto / Black / Negro)

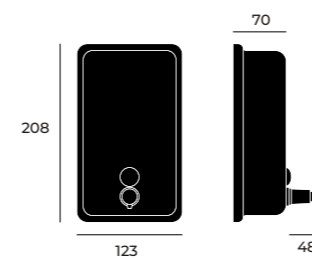

25L

new

Waste bin 25L wall mounted - Black

IN.60.559.B / Un.

*Cesto de papéis de parede /
Wall waste receptacle /
Papelera de pared.*

EN 1.4301 - AISI 304
RAL 9005 (Preto / Black / Negro)

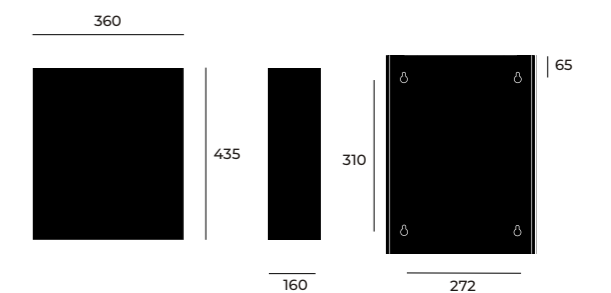

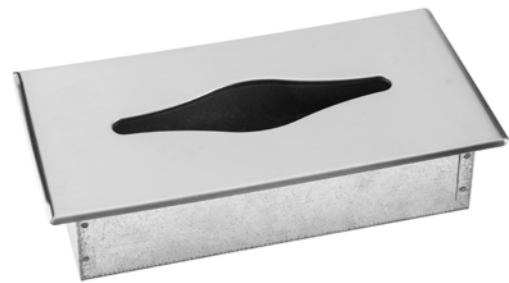

Paper towel dispenser satin finish

IN.60.551.E / Un.



Dispensador de toalhas
de papel de embutir /
Built-in paper towel dispenser /
Dispensador de toallas de papel
de embutir.

EN 1.4301 - AISI 304
Satinado / Satin

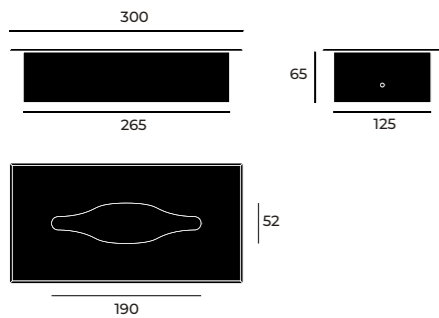

Embedded dispenser for liquid soap

IN.60.544 / Un.



Dispensador de sabão líquido
encastrável /
Embedded soap dispenser /
Dispensador de jabón líquido
encastrable.

EN 1.4301 - AISI 304
Satinado / Satin

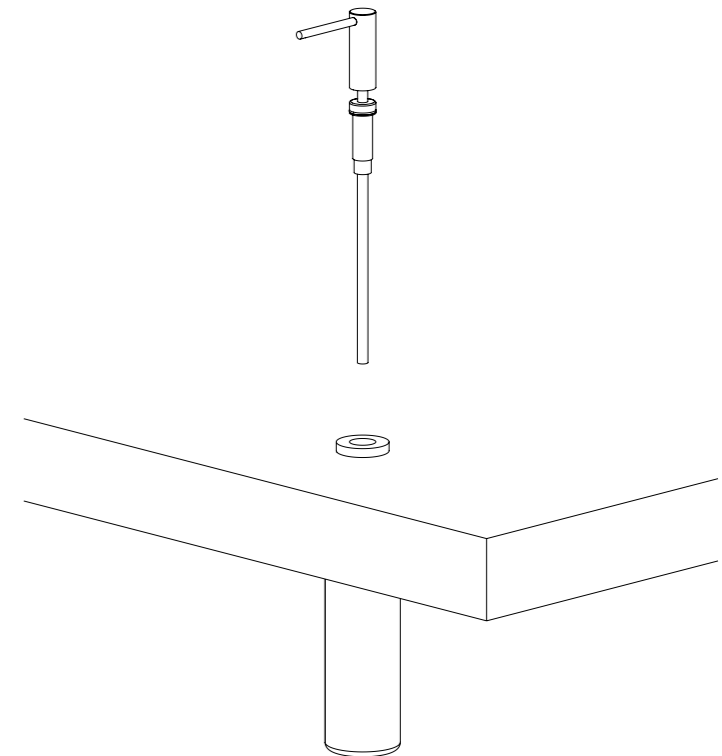
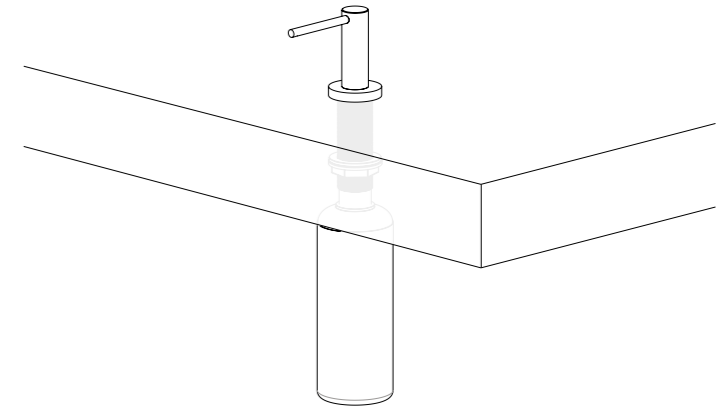
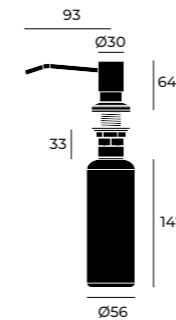



LED

x4
AA (6v)

MÁX.
0,9L

Automatic dispenser for liquid soap

IN.60.550 / Un.

Dispensador de sabão automático. Reservatório plástico com 900cc. Duração das baterias 25,000 ciclos ou 1 ano. Dose: 0,7-0,8cc (adequado para álcool gel, álcool líquido, sabonete líquido, desinfetantes para as mãos, iodo esterilizado e detergentes). Fácil manutenção / Automatic liquid soap dispenser. Plastic container with 900cc. Battery life 25,000 cycles or 1 year. Dose: 0,7-0,8CC. Easy maintenance / Dispensador de jabón automático. Recipiente de plástico con 900cc. Duración de la batería 25,000 ciclos o 1 año. Dosis: 0,7 - 0,8cc. Fácil mantenimiento.

EN 1.4301 - AISI 304
Satinado / Satin

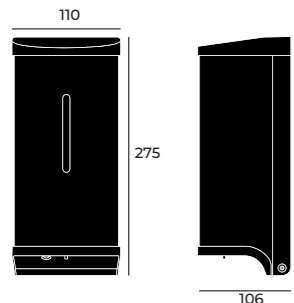

1 Un. 10 Un.





MÁX.
0,5L

Manual dispenser 0,5 L for liquid soap

IN.60.483.05 / Un.

Dispensador de parede para sabão líquido.
Capacidade de 0,5L /
Wall dispenser for liquid soap. Capacity 0,5L /
Dispensador de pared para jabón líquido.
Capacidad 0,5L

EN 1.4301 - AISI 304
Satinado / Satin

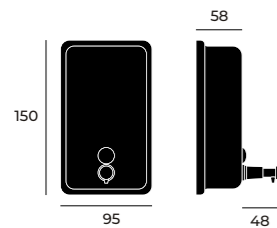

MÁX.
0,5L

Manual dispenser 0,5 L for liquid soap

IN.60.483.05.P / Un.

Dispensador de parede para sabão líquido.
Capacidade de 0,5L /
Wall dispenser for liquid soap. Capacity 0,5L /
Dispensador de pared para jabón líquido.
Capacidad 0,5L

EN 1.4301 - AISI 304
Polido / Polished / Pulido

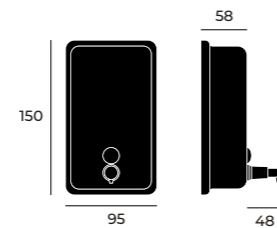

MÁX.
1L

Manual dispenser 1,0 L for liquid soap

IN.60.483.10 / Un.
IN.60.483.10.B / Un.

Dispensador de parede para sabão líquido.
Capacidade de 1,0L /
Wall dispenser for liquid soap. Capacity 1,0L /
Dispensador de pared para jabón líquido.
Capacidad 1,0L.

EN 1.4301 - AISI 304
Satinado / Satin
RAL 9005 (Preto / Black / Negro)

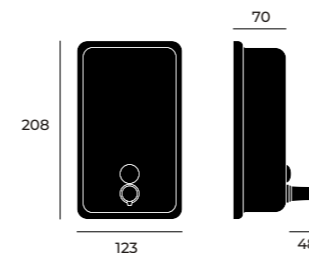

MÁX.
1L

Manual dispenser 1,0 L for liquid soap

IN.60.483.10.P / Un.

Dispensador de parede para sabão líquido.
Capacidade de 1,0L /
Wall dispenser for liquid soap. Capacity 1,0L /
Dispensador de pared para jabón líquido.
Capacidad 1,0L.

EN 1.4301 - AISI 304
Polido / Polished / Pulido

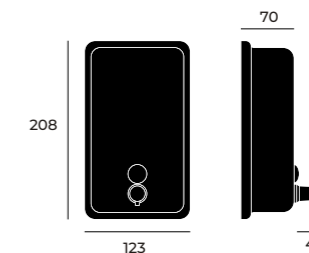



**A GAMA DE ACESSÓRIOS DE APOIO
A PESSOAS COM MOBILIDADE
CONDICIONADA ENCONTRAM-SE
ABRANGIDA PELO DECRETO- LEI N.º
163/2006 DE 8 DE AGOSTO, O QUAL
TEM POR OBJECTO A DEFINIÇÃO
DAS CONDIÇÕES DE ACESSIBILIDADE
A SATISFAZER NO PROJECTO E NA
CONSTRUÇÃO DE ESPAÇOS PÚBLICOS,
EDIFÍCIOS PÚBLICOS E HABITACIONAIS.**

**THE RANGE OF ACCESSORIES TO
SUPPORT PEOPLE WITH REDUCED
MOBILITY IS COVERED BY DECREE-
LAW NO. 163/2006 OF 8 AUGUST,
WHICH AIMS TO DEFINE THE
ACCESSIBILITY CONDITIONS TO BE MET
IN THE DESIGN AND CONSTRUCTION
OF PUBLIC SPACES, PUBLIC BUILDINGS
AND HOUSING.**

**A GAMA DE ACCESORIOS PARA
AYUDAR A LAS PERSONAS CON
MOVILIDAD REDUCIDA, ESTA
AMPARADA POR EL DECRETO-LEY
Nº 163/2006, DE 8 DE AGOSTO, QUE
TIENE POR OBJETO DEFINIR LAS
CONDICIONES DE ACCESIBILIDAD QUE
DEBEN CUMPLIRSE EN EL DISEÑO
Y CONSTRUCCIÓN DE ESPACIOS
PÚBLICOS, EDIFICIOS PÚBLICOS Y
VIVIENDAS.**

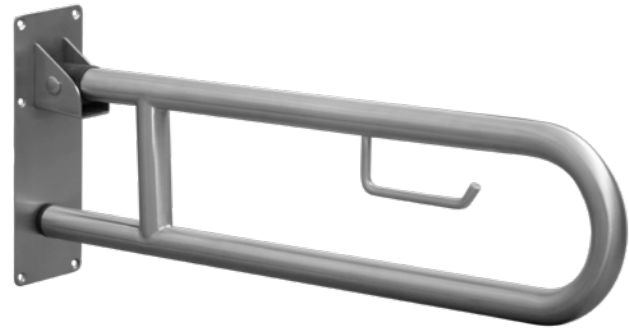

Folding safety support with paper holder

IN.12.002 / Un.

Barra de apoio rebatível com porta
rolo / Folding safety support with paper
holder / Barra de apoyo rebatible con
soporte de papel.

EN 1.4301 - AISI 304
Satinado / Satin

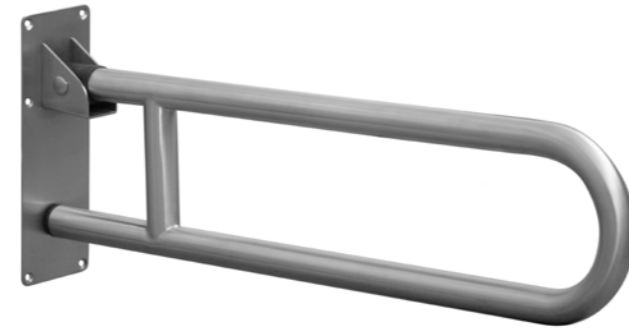
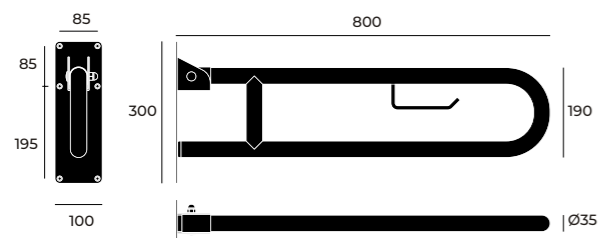
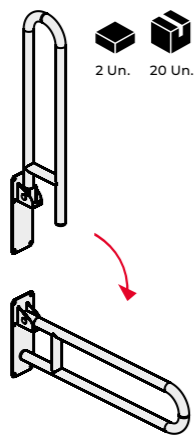

Folding safety support hold open position

IN.12.022 / Un.

Barra de apoio rebatível /
Folding safety support /
Barra de apoyo rebatible.

EN 1.4301 - AISI 304
Satinado / Satin

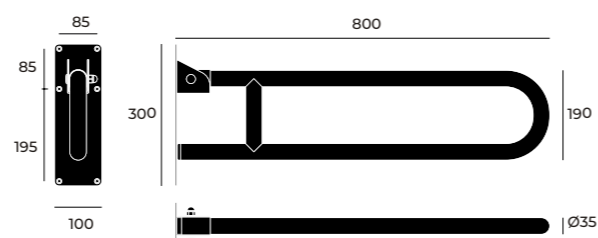
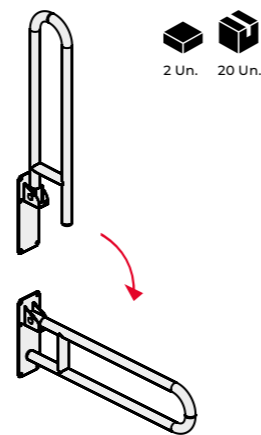

Wall safety support horizontal 90°

IN.12.029 / Un.

Barra de apoio de parede /
Wall safety support /
Barra de apoyo de pared

EN 1.4301 - AISI 304
Satinado / Satin

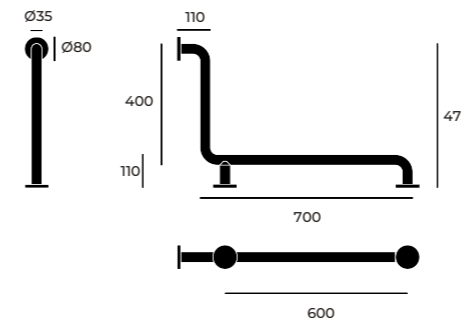



new

Folding safety support with paper holder

IN.12.020 / Un.



*Barra de apoio rebatível com porta rolo /
Folding safety support with paper holder /
Barra de apoyo rebatible con soporte de papel.*

EN 1.4301 - AISI 304
Satinado / Satin

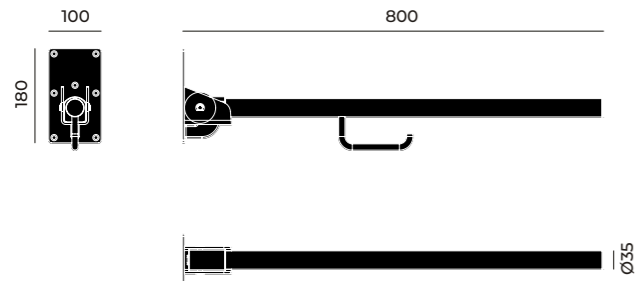

new

Folding safety support with paper holder

IN.12.020.B / Un.



*Barra de apoio rebatível com porta rolo /
Folding safety support with paper holder /
Barra de apoyo rebatible con soporte de papel.*

EN 1.4301 - AISI 304
RAL 9005 (Preto / Black / Negro)

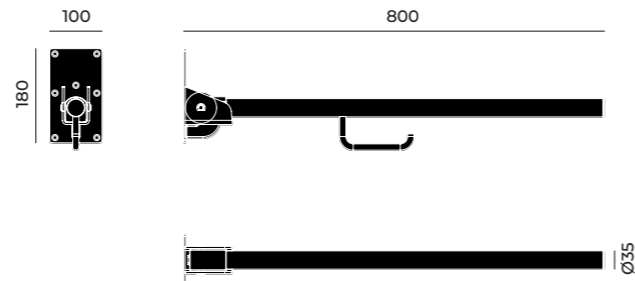



Wall safety support right hand Ø35

IN.12.009.D / Un.
(Direita / Right / Derecha)



*Barra de apoio de parede /
Wall safety support /
Barra de apoyo de pared.*

EN 1.4301 - AISI 304
Satinado / Satin

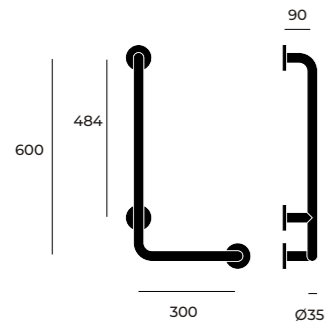

Wall safety support left hand Ø35

IN.12.009.E / Un.
(Esquerda / Left / Izquierda)



*Barra de apoio de parede /
Wall safety support /
Barra de apoyo de pared.*

EN 1.4301 - AISI 304
Satinado / Satin

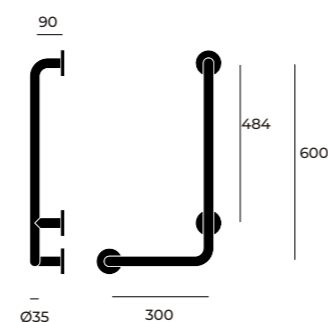

Wall safety support 90 degrees Ø35

IN.12.010 / Un.



*Barra de apoio de parede /
Wall safety support /
Barra de apoyo de pared.*

EN 1.4301 - AISI 304
Satinado / Satin

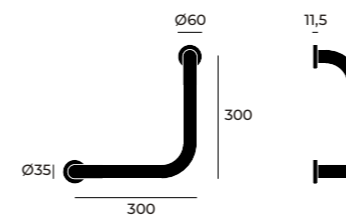

Wall safety support 135 degrees Ø35

IN.12.011 / Un.



*Barra de apoio de parede /
Wall safety support /
Barra de apoyo de pared.*

EN 1.4301 - AISI 304
Satinado / Satin

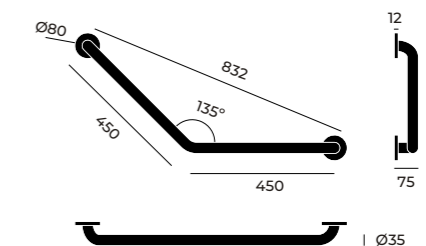

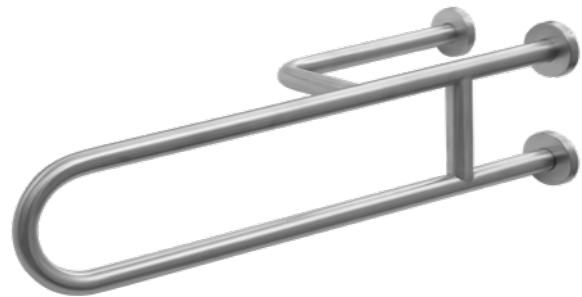

Wall safety support right hand Ø35

IN.12.003.D / Un.
(Direita / Right / Derecha)



*Barra de apoio de parede /
Wall safety support /
Barra de apoyo de pared.*

EN 1.4301 - AISI 304
Satinado / Satin

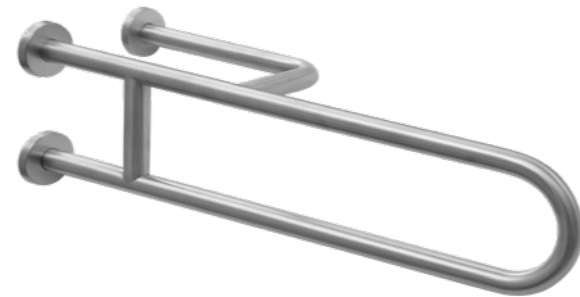
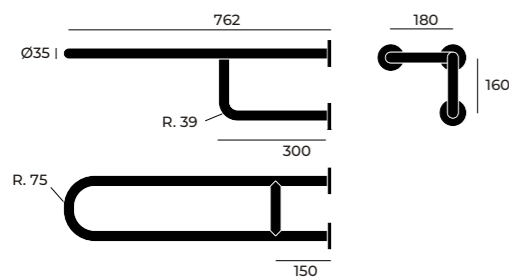

Wall safety support left hand Ø35

IN.12.003.E / Un.
(Esquerda / Left / Izquierda)



*Barra de apoio de parede /
Wall safety support /
Barra de apoyo de pared.*

EN 1.4301 - AISI 304
Satinado / Satin

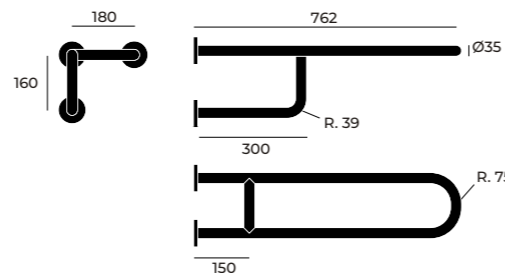

Wall and floor support right hand Ø35

IN.12.015.D / Un.
(Direita / Right / Derecha)



*Barra de apoio de parede /
Wall safety support /
Barra de apoyo de pared.*

EN 1.4301 - AISI 304
Satinado / Satin

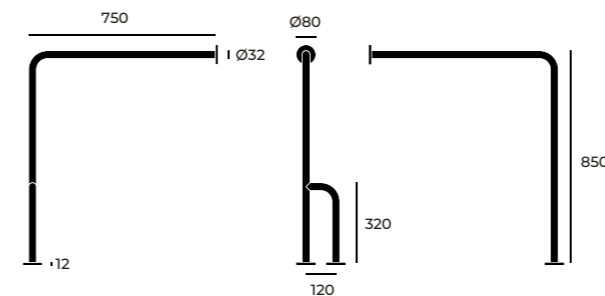

Wall and floor support left hand Ø35

IN.12.015.E / Un.
(Esquerda / Left / Izquierda)



*Barra de apoio de parede /
Wall safety support /
Barra de apoyo de pared.*

EN 1.4301 - AISI 304
Satinado / Satin

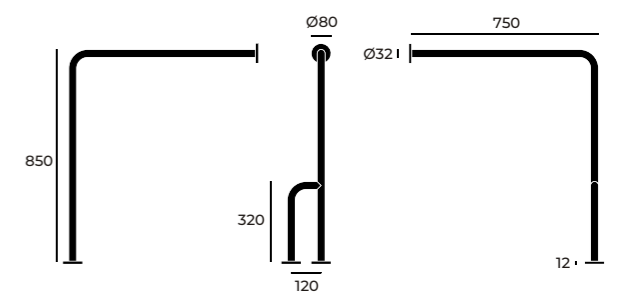

new



Wall safety support

Ø35 - c.c.300/425mm

IN.12.024 / Un.
(Ø35 - c.c. 300mm)



IN.12.025 / Un.
(Ø35 - c.c. 425mm)

*Barra de apoio de parede /
Wall safety support /
Barra de apoyo de pared.*

EN 1.4301 - AISI 304
Satinado / Satin

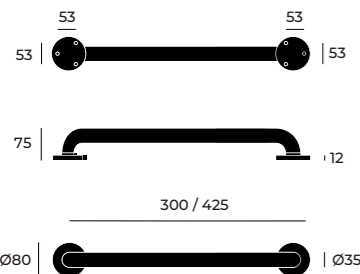

Wall safety support

Ø35 - c.c.600mm

IN.12.026 / Un.
(Ø35 - c.c. 600mm)



*Barra de apoio de parede /
Wall safety support /
Barra de apoyo de pared.*

EN 1.4301 - AISI 304
Satinado / Satin

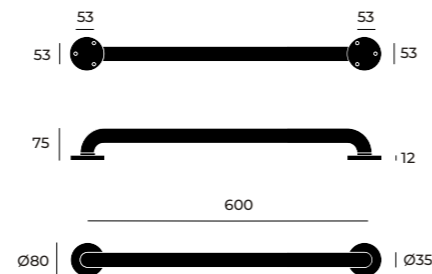

Wall safety support

Ø35 - c.c.800mm

IN.12.027 / Un.
(Ø35 - c.c. 800mm)



*Barra de apoio de parede /
Wall safety support /
Barra de apoyo de pared.*

EN 1.4301 - AISI 304
Satinado / Satin

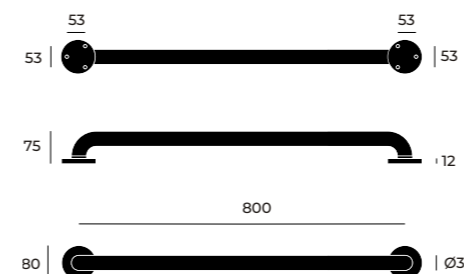

Wall safety support

Ø35 - c.c.1000mm

IN.12.028 / Un.
(Ø35 - c.c. 1000mm)



*Barra de apoio de parede /
Wall safety support /
Barra de apoyo de pared.*

EN 1.4301 - AISI 304
Satinado / Satin

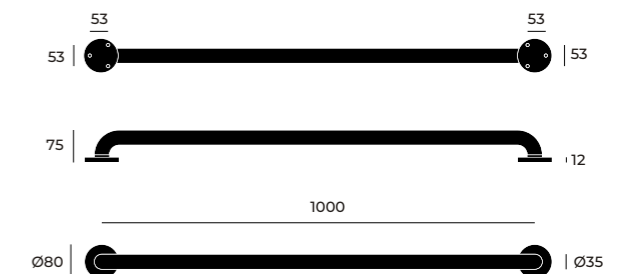



HPL

new

Folding bathroom seat 450

HPL white surface + black core

IN.12.044.450 / Un.

Banco para WC (base em resina fenólica) /
Bathroom seat (phenolic resin base) /
Asiento para baño (base en resina fenólica).

EN 1.4301 - AISI 304
Satinado / Satin

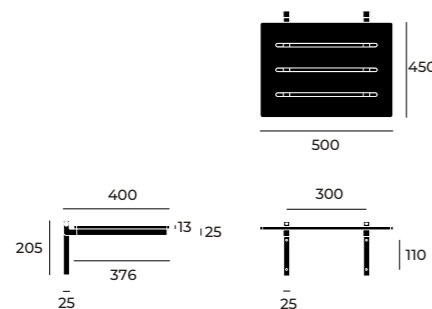

HPL

Folding bathroom seat 500

HPL white surface + black core

IN.12.044 / Un.

Banco para WC (base em resina fenólica) /
Bathroom seat (phenolic resin base) /
Asiento para baño (base en resina fenólica).

EN 1.4301 - AISI 304
Satinado / Satin

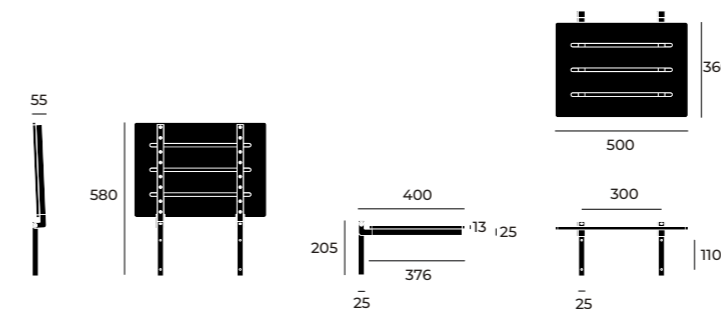

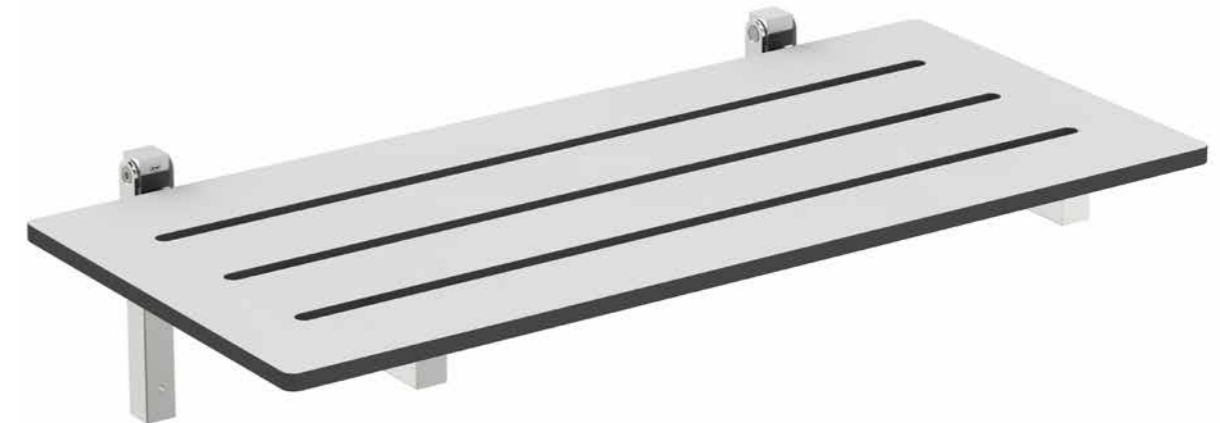

HPL

Folding bathroom seat 800

HPL white surface + black core

IN.12.045 / Un.

Banco para WC (base em resina fenólica) /
Bathroom seat (phenolic resin base) /
Asiento para baño (base en resina fenólica).

EN 1.4301 - AISI 304
Satinado / Satin



1 Un. 4 Un.

(*) Regulamentos de discriminação por deficiência (DDA) /
Disability discrimination act (DDA) / Normativa sobre discriminación por discapacidad.

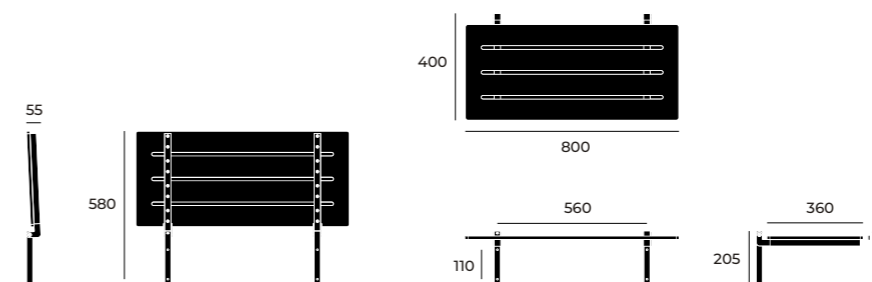

HPL PARTITIONS HARDWARE

FERRAGENS PARA CABINES EM HPL /
HERRAJES PARA CABINAS EN HPL.



HPL

ECO series

Ø25

Adjustable feet for HPL

Ø25mm

SM.025 / Un.



Base regulável para painel /
Adjustable foot /
Pie regulable.

EN 1.4301 - AISI 304
Satinado / Satin

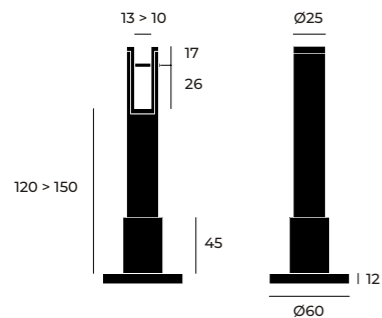

HPL

ECO series

Ø25

Connector tube to HPL

Ø25mm

SM.002.ECO / Un.



Suporte superior para painel /
Upper panel holder /
Soporte superior para panel.

EN 1.4301 - AISI 304
Satinado / Satin

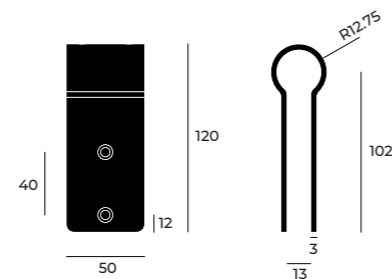

HPL

90°

Ø25

Connector tube to HPL

Ø25mm

SM.012.90 / Un.



Suporte superior para painel /
Upper panel holder /
Soporte superior para panel.

EN 1.4301 - AISI 304
Satinado / Satin

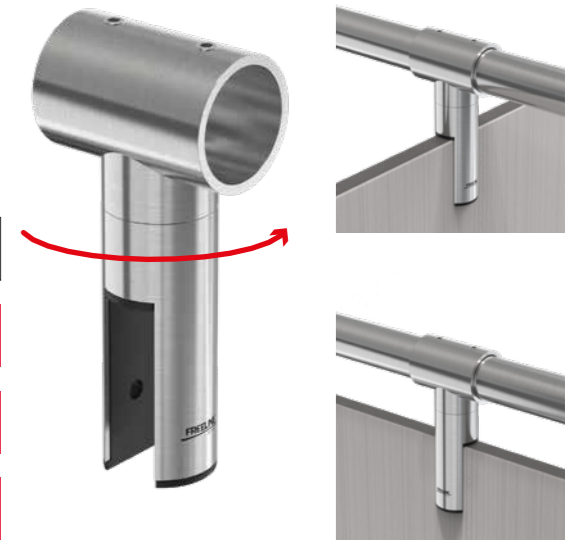
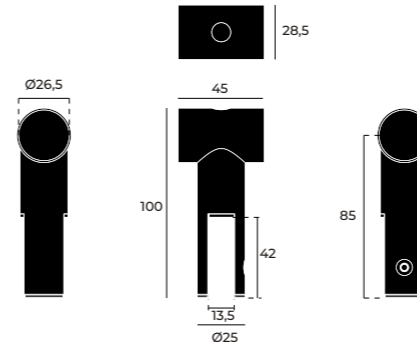

HPL

90°

180°

Ø25

Connector tube to HPL

Ø25mm

SM.012 / Un.



Suporte superior para painel /
Upper panel holder /
Soporte superior para panel.

EN 1.4301 - AISI 304
Satinado / Satin

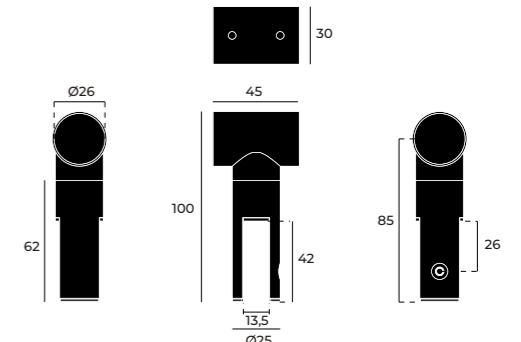



HPL

Ø25

Tube connector for HPL Ø25mm

SM.015 / Un.



União de tubo a 90° para tubo de Ø25mm /
Tube connector at 90° for Ø25mm tube /
Unión de tubo a 90° para tubo de Ø25mm

EN 1.4301 - AISI 304
Satinado / Satin

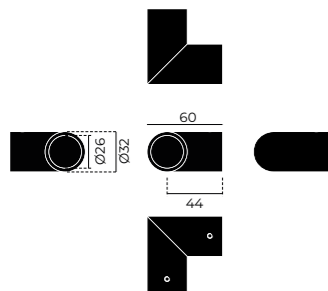

Ø25

Tube Ø25mm

SM.010.A.25.2000 / Un.
SM.010.A.25.3000 / Un.
SM.010.A.25.6000 / Un.



Tubo de Ø25 com 2000mm, 3000mm e 6000mm /
Ø25 tube with 2000mm, 3000mm and 6000mm /
Tubo Ø25 con 2000mm, 3000mm y 6000mm.

EN 1.4301 - AISI 304
Satinado / Satin

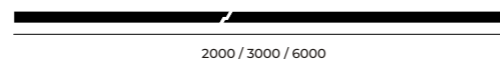
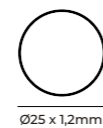



Ø25

Two way connector Ø25mm

SM.032.25 / Un.



União de tubo a 90° para tubo Ø25mm /
Tube connector at 90° for Ø25mm tube /
Union de tubo a 90° para tubo de Ø25mm.

EN 1.4301 - AISI 304
Satinado / Satin

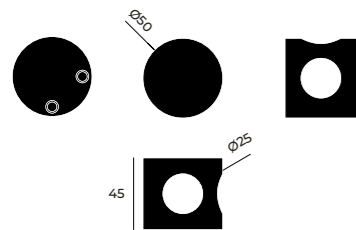

Ø25

Connector tube-tube Ø25mm

SM.010.C.25 / Un.



Conector para tubo Ø25mm /
Tube connector Ø25mm /
Conector para tubo Ø25mm

Alumínio /
Aluminium / Aluminio

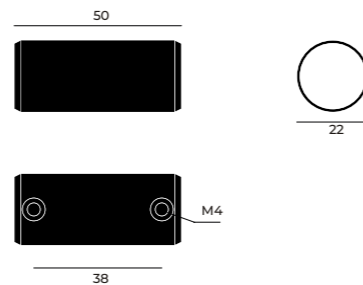

Ø25

Tube wall support Ø25mm

SM.011.25 / Un.



Suporte de tubo com fixação à parede /
Wall mounting tube support /
Soporte de tubo con sujeción a pared.

EN 1.4301 - AISI 304
Satinado / Satin

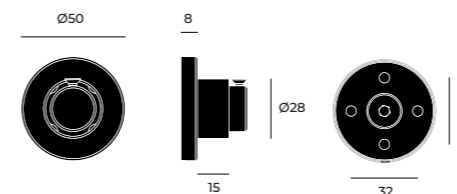

Ø25

Three way connector Ø25mm

SM.033.25 / Un.



União de tubo a 90° e 180°
para tubo de Ø25mm /
Tube connector at 90° and 180°
for Ø25mm /
Union de tubo a 90° y 180°
para tubo de Ø25mm.

EN 1.4301 - AISI 304
Satinado / Satin

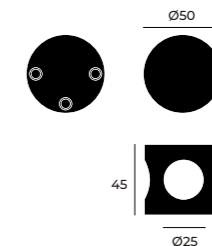



HPL

Ø25

Double L support for HPL boards

SM.014 / Un.



Suporte para painel /
Panel holder /
Soporte para panel.

EN 1.4301 - AISI 304
Satinado / Satin

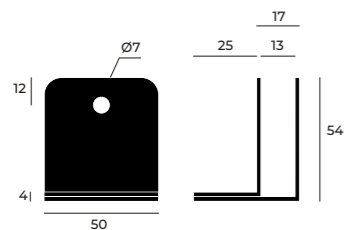

HPL

Ø25

T Panel support for HPL boards

SM.034 / Un.



Suporte para painel /
Panel holder /
Soporte para panel.

EN 1.4301 - AISI 304
Satinado / Satin

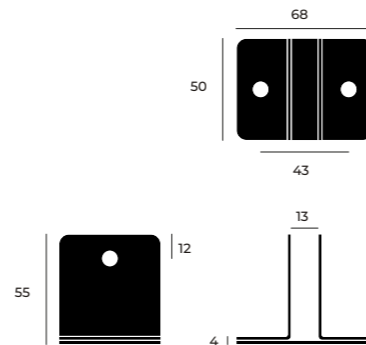

HPL

Ø25

L Panel support for HPL boards

SM.044 / Un.



Suporte para painel /
Panel holder /
Soporte para panel.

EN 1.4301 - AISI 304
Satinado / Satin

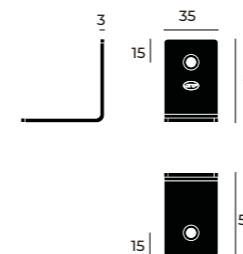

HPL

Ø25

L Panel support for HPL boards

SM.004 / Un.



Suporte para painel /
Panel holder /
Soporte para panel.

EN 1.4301 - AISI 304
Satinado / Satin

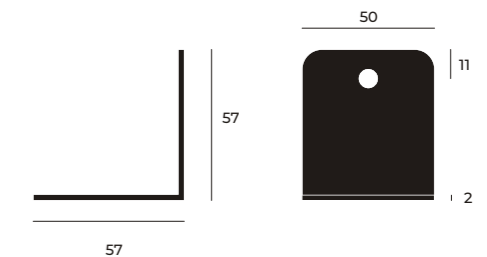



U Panel support for HPL boards

SM.024 / Un.



Suporte para painel /
Panel holder /
Soporte para panel.

EN 1.4301 - AISI 304
Satinado / Satin

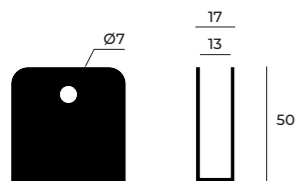

Reinforced U profile in aluminium for HPL

SM.103 / Un.



Perfil em "U" para painel até 13mm
"U" shape profile until 13mm panel /
Perfil en "U" para panel de 13mm.

Alumínio /
Aluminium / Aluminio

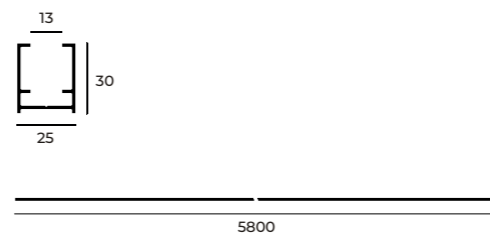

U profile for HPL panel in aluminium

SM.101.AL.3000 / Un.
SM.101.AL.6000 / Un.



Perfil em "U" para painel até 13mm com
3000mm ou 6000mm.

"U" shape profile until 13mm panel with
3000mm and 6000mm /
Perfil en "U" para panel de 13mm con
3000mm ou 6000mm.

Alumínio /
Aluminium / Aluminio

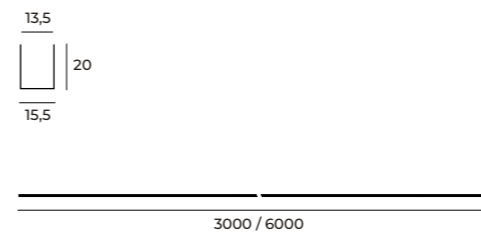

Double door knob for HPL

IN.75.030 / Par



Puxador para portas de vidro ou fenólico /
Knobs for glass or phenolic doors /
Pomos para puerta de cristal o fenolico.

EN 1.4301 - AISI 304
Satinado / Satin

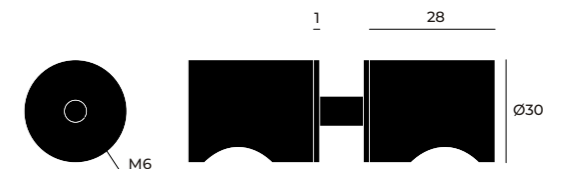



HPL

Double door knob anti-vandalism

SM.019 / Un.



*Puxador de porta duplo anti-vandalismo /
Double door knob with anti-vandalism fixing /
Tirador de puerta doble anti-vandalismo.*

EN 1.4301 - AISI 304
Satinado / Satin

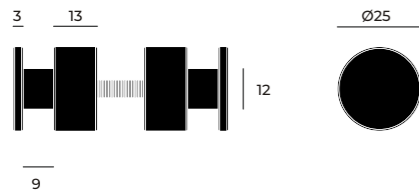

HPL

Double door knob anti-vandalism

SM.020 / Un.

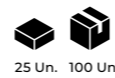

*Puxador de porta duplo anti-vandalismo /
Double door knob with anti-vandalism fixing /
Tirador de puerta doble anti-vandalismo.*

EN 1.4372 - AISI 201
Satinado / Satin

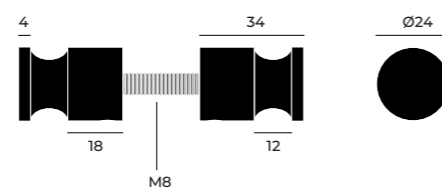

The 1st one bathroom latch

SM.026 / Un.



*Fecho para wc com indicador
de cor (livre-ocupado) /
Bathroom latch with color indicator
(vacant - occupied) /
Cierre de baño con indicador
(libre - ocupado).*

EN 1.4301 - AISI 304
Satinado / Satin

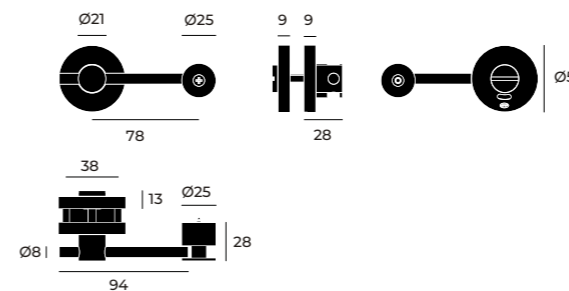

Bathroom latch with hook

SM.027 / Un.



*Fecho para wc para portas de correr
com indicador de cor (livre-ocupado) /
Bathroom latch for sliding doors with
color indicator (vacant - occupied) /
Cerradura de baño para puertas correderas
con indicador de color (libre-ocupado).*

EN 1.4301 - AISI 304
Satinado / Satin

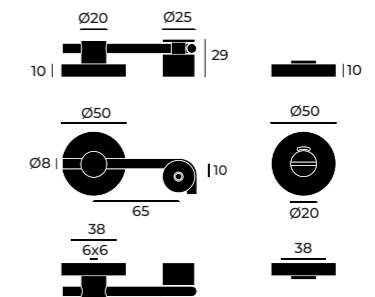



Snib indicator bolt with sliding lever

IN.17.616 / Un.



Fecho com indicador de cor.
Espessura 12-35mm |
Slide bolt with color indicator.
Thickness 12-35mm |
Cierre con indicador de color.
Espesor 12-35mm.

EN 1.4301 - AISI 304
Satinado / Satin

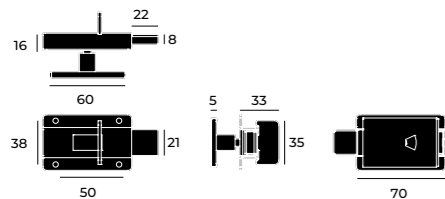

Bolt with sliding lever surface mounting

IN.17.617 / Un.



Fecho de sobrepor com alavanca deslizante |
Surface mounting bolt with sliding lever |
Pasador de sobreponer con leva deslizante.

EN 1.4301 - AISI 304
Satinado / Satin

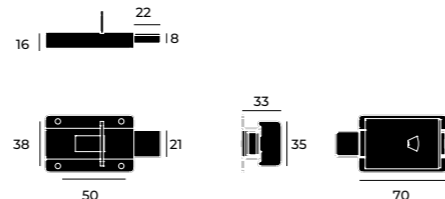

Bathroom latch with indicator

SM.02039 / Set



Fecho para wc com indicador
de cor (livre-ocupado) /
Bathroom latch with color
indicator (vacant - occupied) /
Cierre de baño con indicador
(libre - ocupado)

ZAMAK - cor inox /
Zamak - inox color / ZAMAK - color acero inoxidable

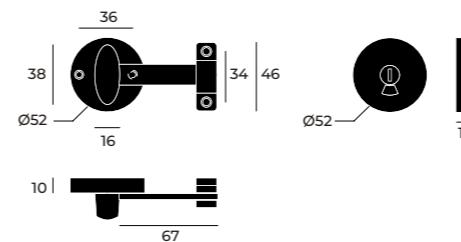

Bathroom latch with indicator

SM.051 / Set



Fecho para wc com indicador
de cor (livre-ocupado) /
Bathroom latch with color indicator
(vacant - occupied) /
Cierre de baño con indicador
(libre - ocupado)

EN 1.4301 - AISI 304
Satinado / Satin

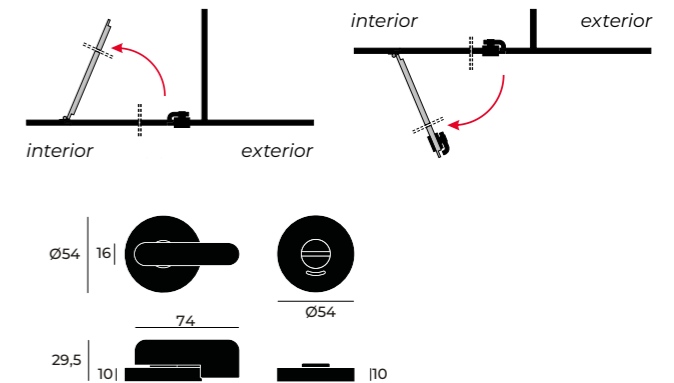

HPL HINGES WITH COVERS

DOBRADIÇAS PARA HPL COM TAMPAS /
BISAGRAS PARA HPL CON CUBIERTAS.



x3
20 Kg

HPL

Spring hinge for HPL with concealed fixings

SM.005.E / Un.



Dobradiça para HPL com mola
ajustável e fixações ocultas.
Parafusos incluídos /
Adjustable spring hinge for HPL with
concealed fixings. Screws included /
Bisagra para HPL con resorte ajustable y
fijaciones ocultas. Tornillos incluidos.

EN 1.4301 - AISI 304
Satinado / Satin

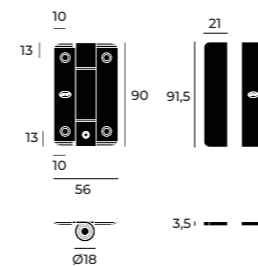

x3
20 Kg

HPL

Hinge for HPL with concealed fixings

SM.005.F / Un.



Dobradiça para HPL com fixações
ocultas. Parafusos incluídos /
Hinge for HPL with concealed fixings.
Screws included /
Bisagra para HPL con fijaciones ocultas.
Tornillos incluidos

EN 1.4301 - AISI 304
Satinado / Satin

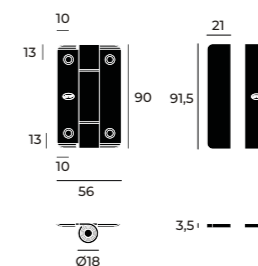



HPL

HPL Cabinet flat hinge reversible with spring

SM.005.C / Un.



Dobradiça de sobrepor com mola para auto-fecho. Reversível. Mola com força ajustável / Flat hinge to overlap with spring for self closing. Reversible. Spring with power adjustment / Bisagra plana de sobreponer con muelle para autocierre. Reversible. Muelle con ajuste de fuerza.

EN 1.4372 - AISI 201
Satinado / Satin

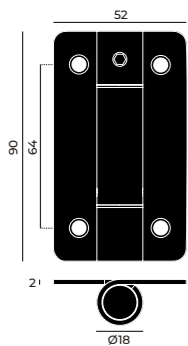

HPL

HPL Cabinet flat hinge reversible without spring

SM.005.B / Un.



Dobradiça de sobrepor. Reversível / Flat hinge to overlap. Reversible / Bisagra plana de sobreponer. Reversible.

EN 1.4372 - AISI 201
Satinado / Satin

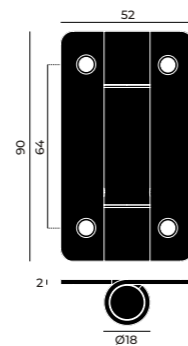

HPL

HPL Cabinet flat hinge reversible

SM.005.D.ECO / Un.



Dobradiça de sobrepor. Reversível / Flat hinge to overlap. Reversible / Bisagra plana de sobreponer. Reversible.

EN 1.4372 - AISI 201
Satinado / Satin

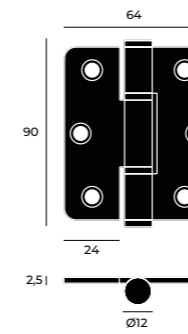

HPL

HPL Cabinet flat hinge reversible

SM.005.A.ECO.D / Un.



(Direita / Right / Derecha)
SM.005.A.ECO.E / Un.
(Esquerda / Left / Izquierda)

Dobradiça de sobrepor / Flat hinge to overlap / Bisagra plana de sobreponer.

EN 1.4372 - AISI 201
Satinado / Satin

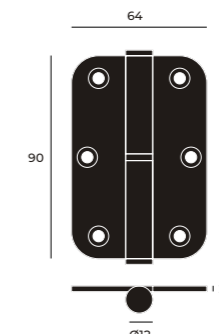



Boat hook P1 hook AISI 316

IN.14.546.F / Un.



Cabide | Hook | Percha

EN 1.4401 - AISI 316
Satinado / Satin

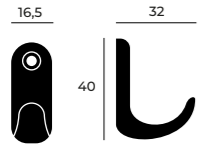

Hang hook

IN.14.030 / Un.



Cabide | Hook | Percha

EN 1.4301 - AISI 304
Satinado / Satin

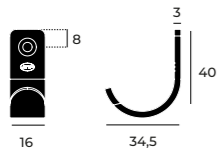

Cabinet hook double hook

IN.14.530.ECO / Un.



Cabide duplo | Double hook | Percha doble.

EN 1.4301 - AISI 304
Satinado / Satin

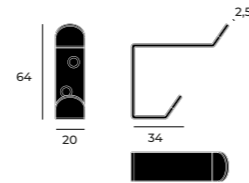

You need me hook

IN.14.010 / Un.



Cabide | Hook | Percha

EN 1.4301 - AISI 304
Satinado / Satin

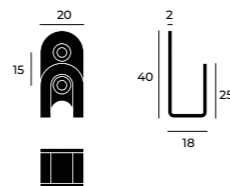

Cabinet hook + stopper double function

IN.14.529.ECO / Un.



Cabide duplo com batente de porta |
Double hook with door stopper |
Percha doble con tope de puerta.

EN 1.4301 - AISI 304
Satinado / Satin

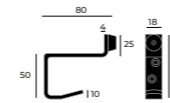

Cabinet hook + stopper double function

SM.008 / Un.



Cabide com batente de porta |
Hook with door stopper |
Percha con tope de puerta.

EN 1.4301 - AISI 304
Satinado / Satin

