

WHAT'S NEW JNF 2025

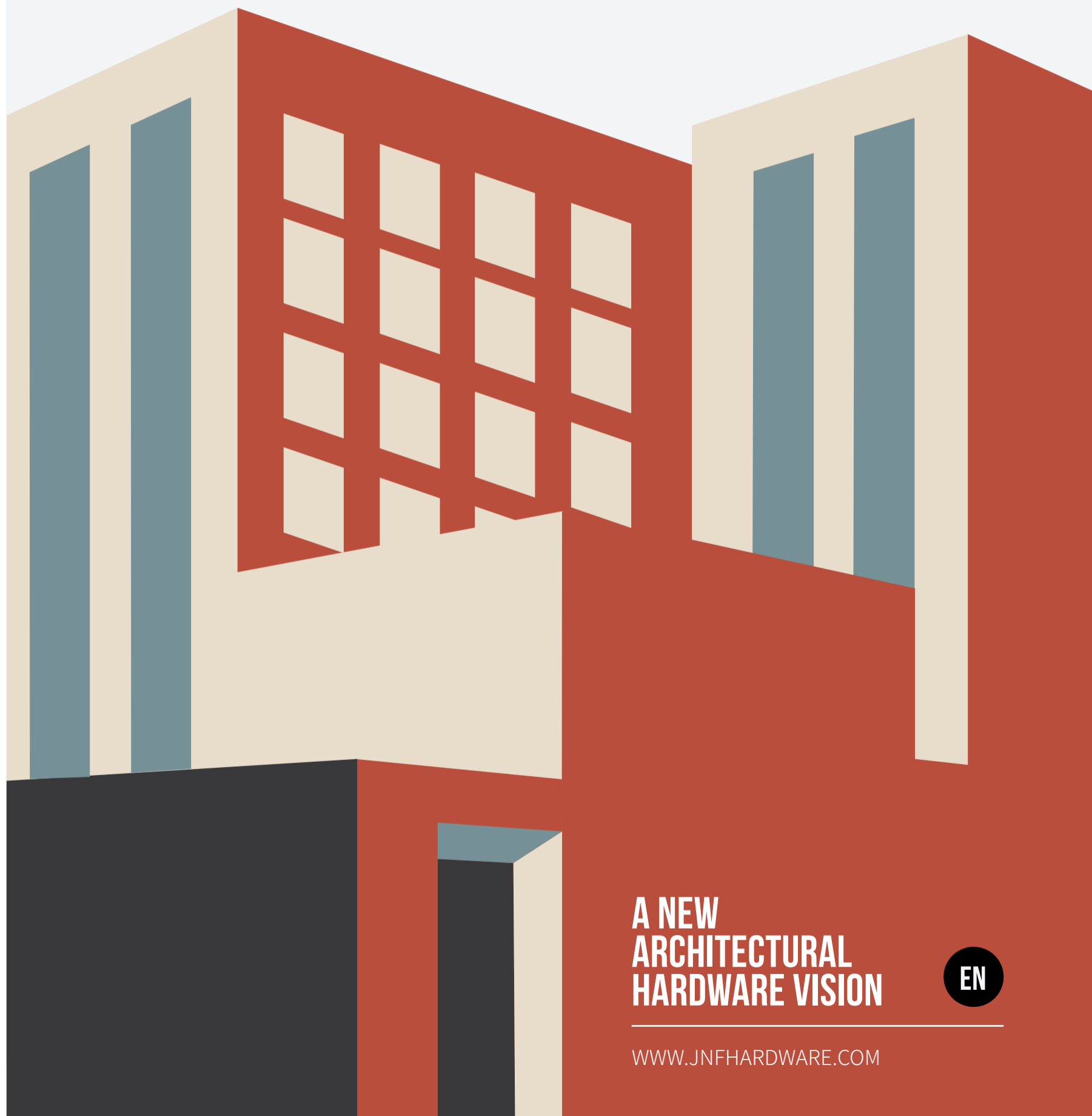

ARCHITECTURAL
HARDWARE



A NEW
ARCHITECTURAL
HARDWARE VISION

EN

WWW.JNFHARDWARE.COM

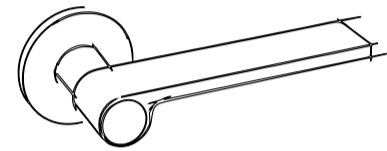

Welcome to JNF - Achitectural Hardware

We are an architectural hardware company specializing in providing high-quality hardware solutions tailored to meet the unique needs of every project.

With a strong focus on durability, functionality, and aesthetics, we provide a wide range of innovative products tailored to meet the diverse needs of residential, commercial, and industrial projects.



WHAT'S NEW 2025



OPORTO

THE ORIGINS OF JNF

Our company began operations in 1965, and over the course of almost six decades has followed the evolution of the world of construction hardware.

We are a company with an unusual synergy in our business area: we have production, product design team, engineering, research and development, marketing, communication, sales network and customer service.

Our main activity is the production of hardware for furniture and construction, with a trajectory of continuous evolution and adaptation to the

economy and market challenges, dedicating special attention to the development of solutions that meet the trends of contemporary architecture.

We have a dynamic team that seeks to create innovative solutions in a clear and appropriate way, always reaffirming the company's identity and its positioning in the market.

We are very active in observing international market trends, including in different areas, with a considerable number of new projects permanently under development.



GENERAL INDEX

WHAT'S NEW 2025

VOYAGER	006
VOYAGER CORPORATE	010
PENDULUM	014
GHOST LOCK	018
DUAL MAG	021
COPLAN SERIES	022
DIN LOCKS	028
MAGNACORE	032
MAGNALITE	033
FLAT LOCK	036
MAGSTRING	037
PULSELOCK	038
SMOOTH CLOSE	040
BATHROOM SNIB INDICATORS	044
SLIDING DOOR LOCKS	046
NATUR LINEA COLLECTION	050
LINEA COLORS COLLECTION	052
SIMPLE COLLECTION	054
EDGE FLOW COLLECTION	056
TOKYO COLLECTION	058
GREAT TOKYO COLLECTION	059
INDUSTRIAL DESIGN	062
LOFT SERIES	066
ROSES	068
LOVEGROVExJNF	070
HYDRAULIC PIVOTS	088

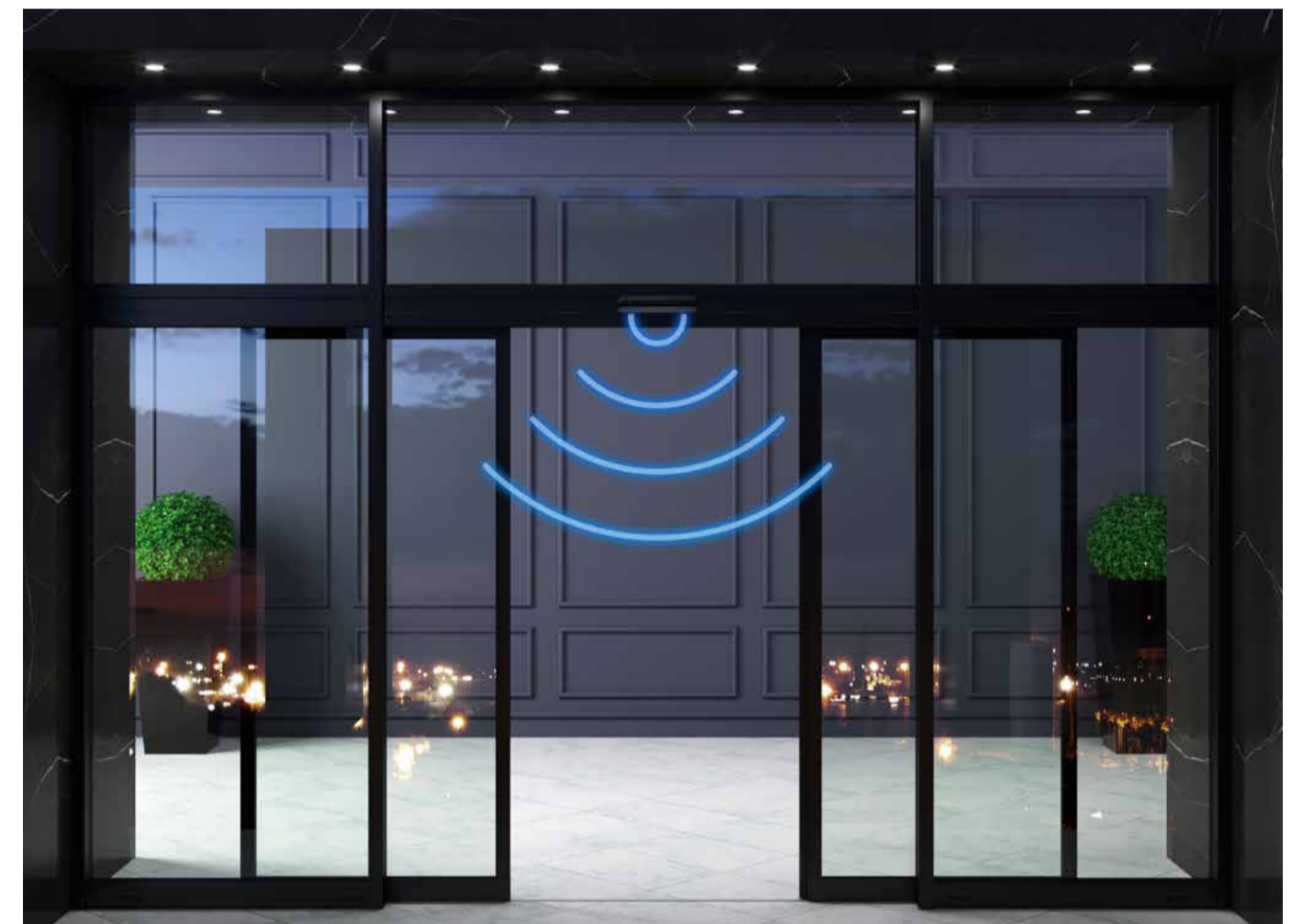

VOYAGER

THE FUTURE IS WIRELESS

VOYAGER is an innovative access control software that allows you to control your door from anywhere in the world.

JNF developed an application that is available on the App Store, Google Play and URL for any device (web version).

All the application's features were designed to be simple and intuitive for users.

The main advantage of this application is the possibility of controlling all devices remotely, thus providing greater convenience to users.

Manage your hotel with complete security, with the **VOYAGER** system you don't have to worry about security.

The entire access control system is equipped with the most advanced technological resources. They can be managed in a closed autonomous LAN network or in CLOUD.

The future is wireless. With the **VOYAGER** system it is no longer required to have a wire network to have real time control on the devices.



It has never been easier to manage access and security with different solutions, for rentals, hotels and even private homes. Everything in the palm of your hand. Offer a hassle-free check-in experience.

Our interactive features will help you in your day to day management of all devices.

Full control over devices with the possibility of creating different access systems, using PIN, Card, Virtual Key or Fingerprint. Also is possible to share devices with other users.

Organize your devices into different groups that are fully managed by you.

All features were designed to be simple and intuitive for users, easy to interpret without the need for training or manuals. Application available on different interfaces: APP for Smartphone, Tablet and URL for any device.

You can consult all operations performed including online registrations.

Through NFC technology you can register your NFC cards or use your phone to open the door.

Also you can visit our support center for any queries regarding all devices.

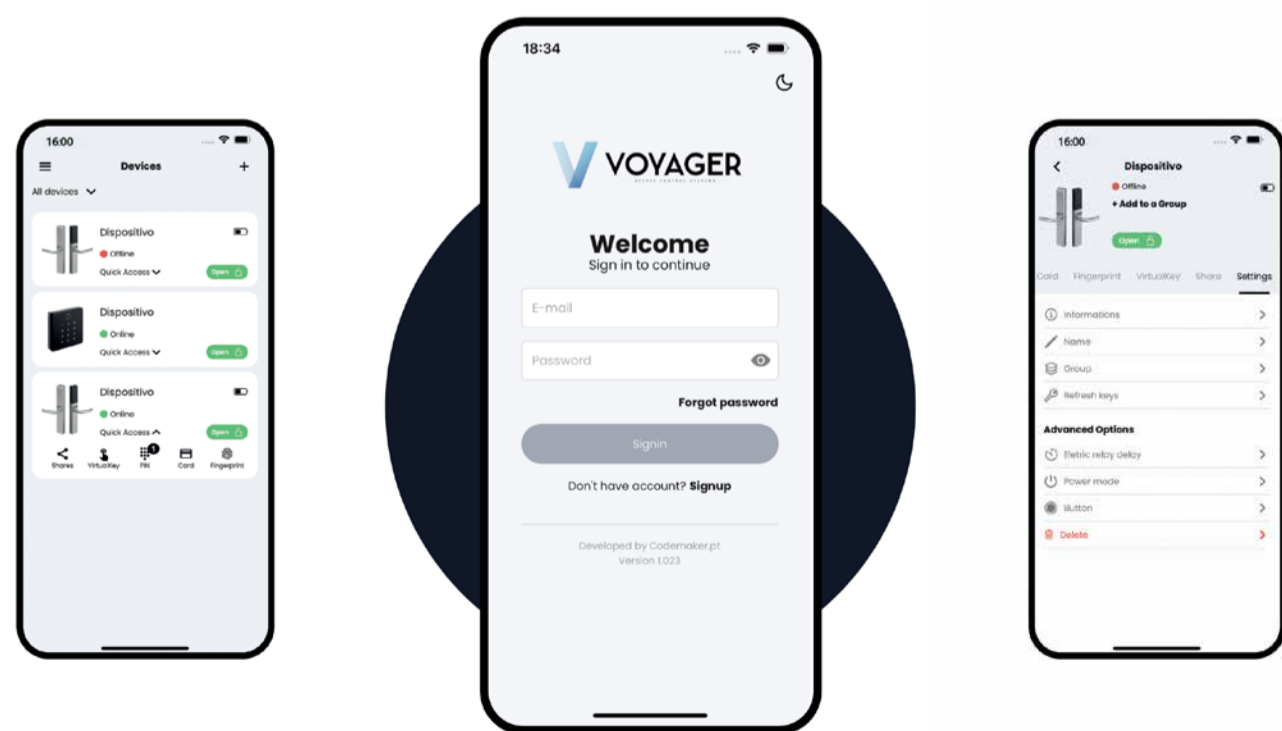

CITY
IN.27.500



MAXIM NUMERIC
IN.27.560

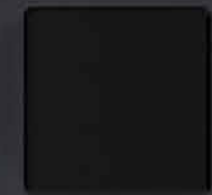

WALL CONTROL
IN.28.204.BLE



WALL CONTROL NUMERIC
IN.27.520



ART DECO
IN.27.300



SKY
IN.20.602



DRESS CODE
IN.27.350



S90 - S-TRONIC
IN.19.S90



BILLY
IN.27.501



MOBIL GUARD
IN.28.120





THE ACCESS CONTROL SOLUTION FOR HOTEL MANAGEMENT

010



011

VOYAGER CORPORATE

ACCESS CONTROL SOLUTION FOR HOTEL MANAGEMENT

The hotel industry is increasingly linked to technology for better management and access control.

JNF developed a software designed for the hotel industry, with the aim of ensuring greater security, comfort and accessibility to most of the services available at the hotel.

The **VOYAGER CORPORATE** software can be supplied with a local server, to guarantee greater security and autonomy

in access management, as well as customized services tailored to each hotel.

Multiple services will be available on each guest's smartphone using the **VOYAGER CORPORATE**.

This application is prepared to establish a direct connection between the guest and the hotel. Greater comfort and speed when dealing with a guest's most demanding requests.



012



User experiences with mobile resources are increasingly common, comfortable and fast.

This new access control technology, in addition to guaranteeing entrances to the hotel room, can also be used to schedule other services available at the hotel, such as access to the spa, breakfast service, or even a late check-out.

All these services can be notified and compiled into monthly reports to analyze occupancy as well as service performance.

These are examples of what will be possible to manage with this new software.

All services available in the palm of your hand, for a more comfortable experience. A hotel management service that gives you the flexibility and reliability you need, without compromising the security of your hotel.

Area dedicated to human resources management, with monitoring of services such as cleaning, reception and maintenance. Different types of access permissions to different areas of the hotel.

Access to all entry records for internal users. Control of the cleanliness of the rooms. Automatic issuance of cleaning service after guest check-out.

013

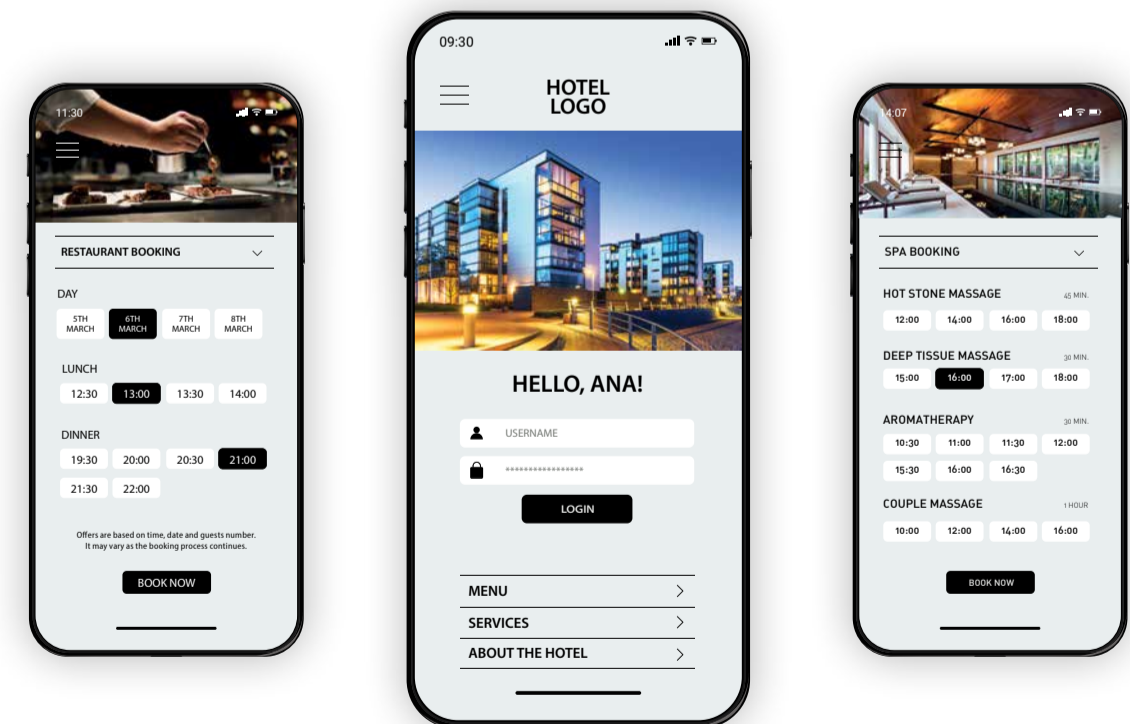

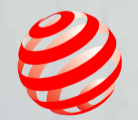

reddot winner 2022

IN.20.925.TCO

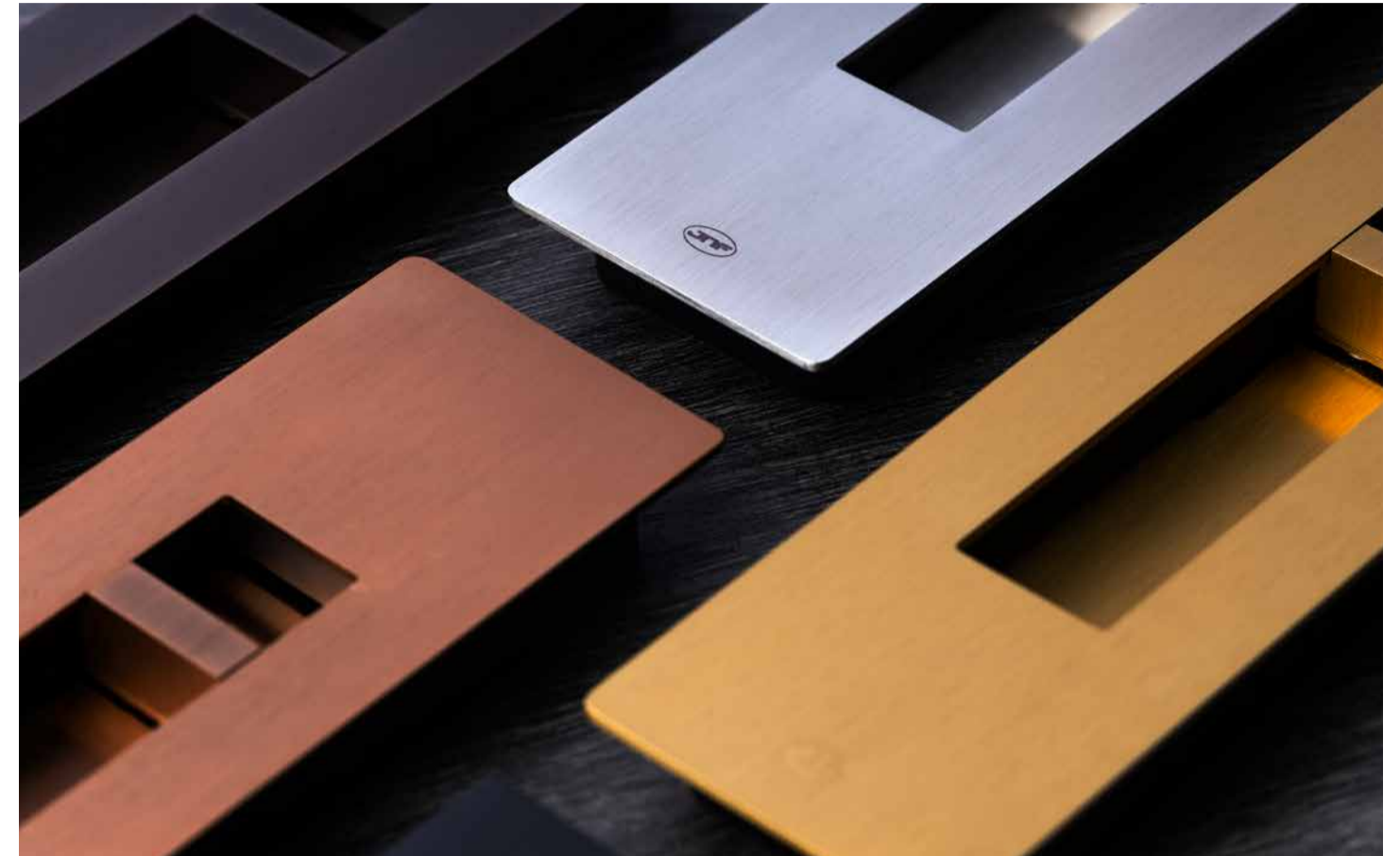

PENDULUM

THE PERFECT COMBINATION OF DESIGN AND FUNCTIONALITY

JNF developed an innovative magnetic lock with flush handle concept for sliding doors.

The concept was based in the simplicity of operation, basic shapes, ergonomics and very easy installation.

The activation and locking without noise was one of our main focus on the development, as this type of locks is mainly used for residential purpose the comfort is mandatory.

JNF is proud to announce that the **PENDULUM** magnetic sliding door lock, has won a Red Dot Award in the "Product Design" category, one of the world's largest design competitions.

"The PENDULUM magnetic sliding door lock impresses with its elegance, conclusively combining the shape of the rectangle and the function of the innovative magnetic lock" – statement by the jury.



PENDULUM ULTRA SILENT MAGNETIC LOCK FOR SLIDING DOORS

Ergonomic and without aggressive edges, even with square shapes, is achieved with careful production, with special attention to all the small details, such as making this product suitable for handling by people with disabilities.

JNF has applied for a patent and design protection for this model, as the design and mechanical characteristics of this lock stand out from what we are used to seeing on the market.

Our priority is that our products maintain their original quality for generations, ensuring the trust of our customers. And we can proudly say that **PENDULUM** lives up to this expectation, and is also an example of a product that is in balance with architecture.

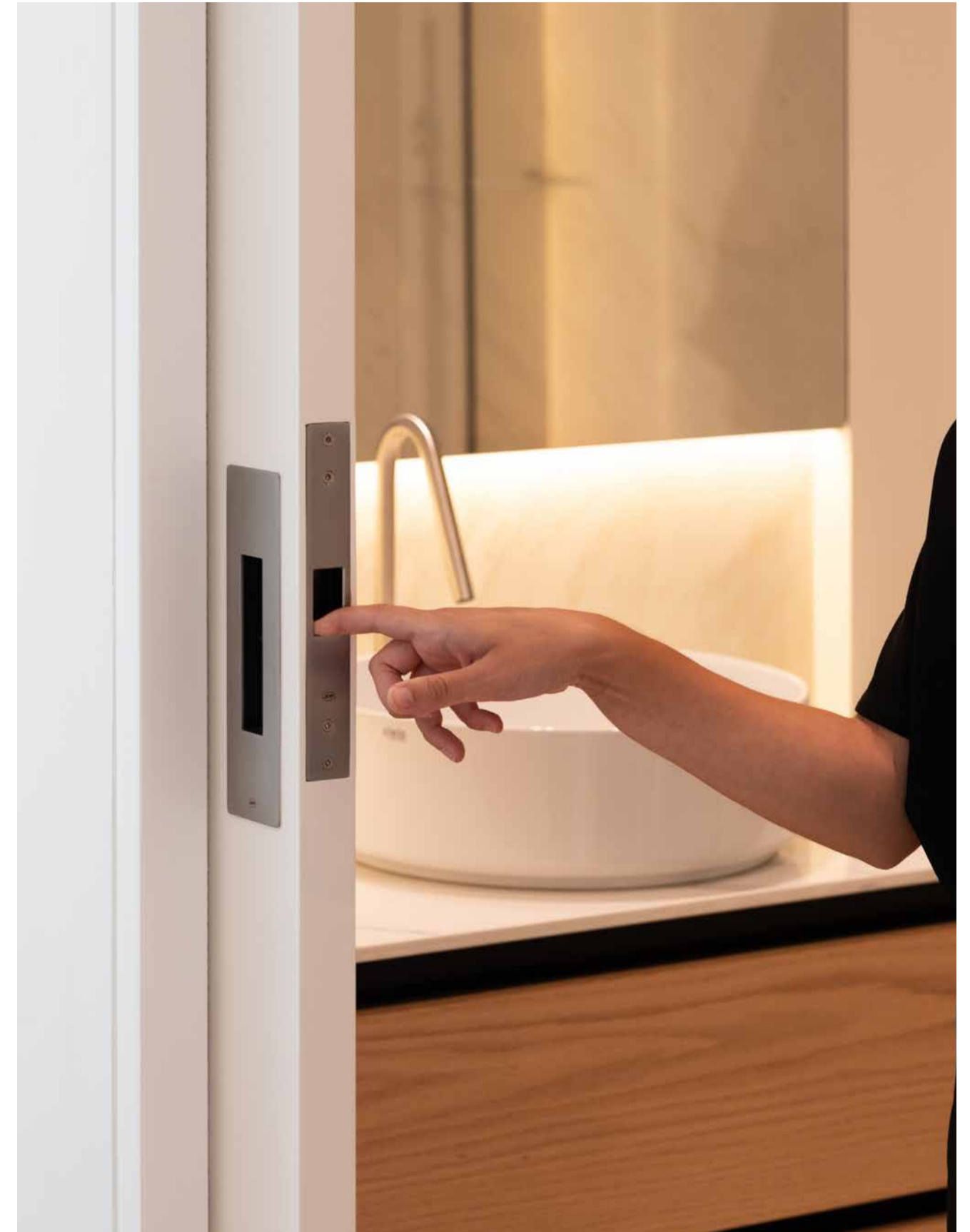



GHOST LOCK

MAGNETIC HOLDER + LATCH

Presented on the market for several years, this locking system for sliding or rebated doors, together with a magnetic retainer, holds the door in place. This system is highly ergonomic and an alternative to the traditional door handle.

Its sleek design integrates seamlessly into contemporary or traditional interiors, enhancing both the look and practicality of your space. Durable, reliable and easy to install, this locking system is the ultimate choice for those seeking to elevate their doors' performance and style.

PRIVACY (for rebated doors), This setting ensures a secure and controlled closure, providing complete privacy. Ideal for areas where confidentiality and security are important, such as offices, bathrooms, or bedrooms.

Innovative locking mechanism: Features a concealed lever inside the flush handle, activating the lock with a simple downward motion for seamless operation.

Emergency access: From the outside, the lock can be easily overridden using a special key, ensuring safety and accessibility when needed.

Minimalist design: The sleek and flush-mounted handle complements modern interiors while keeping functionality discreet.

User-Friendly: Intuitive operation makes it easy to lock and unlock without compromising on aesthetics.

Reliable and secure: Built with durable materials for long-lasting performance and peace of mind.



GHOST LOCK FOR SLIDING DOORS

PRIVACY (for sliding doors), This setting ensures a secure and controlled closure, providing complete privacy. Ideal for areas where confidentiality and security are important, such as offices, bathrooms, or bedrooms.

Innovative locking mechanism: Features a concealed lever inside the flush handle, activating the lock with a simple downward motion for seamless operation.

Emergency access: From the outside, the lock can be easily overridden using a special key, ensuring safety and accessibility when needed.

Minimalist design: The sleek and flush-mounted handle complements modern interiors while keeping functionality discreet.

User-Friendly: Intuitive operation makes it easy to lock and unlock without compromising on aesthetics.

Reliable and secure: Built with durable materials for long-lasting performance and peace of mind.

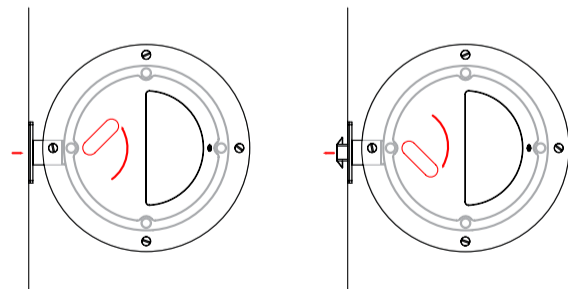
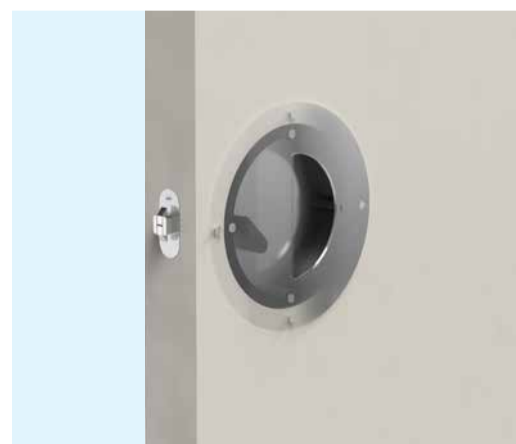

DUALMAG FOR PASSAGE DOORS



DUALMAG is a magnetic door holder with dual attraction options.

Two magnetic strengths: Choose between two levels of magnetic attraction power to perfectly suit your door's size and weight.

No locking elements: Keeps the door securely in the closed position using only magnetic force. Simple, sleek and effective.

Smooth and silent operation: Ensures a gentle hold and release without noise or wear on the door or frame.

Minimalist design: Perfect for modern interiors, offering functionality without compromising on aesthetics.

Versatile application: Suitable for various door types, providing reliable performance and ease of use.

Upgrade to a clean, locking-free solution for maintaining door closure with our innovative magnetic door holder.



IN.17.012 > DUAL MAG PRO
POWER 52KG



IN.17.013 > DUAL MAG
POWER 28KG



FIRE PROOF



3D
ADJUSTMENT
HINGES

200.000 CYCLES



COPLAN SERIES

3D INVISIBLE HINGE

The **COPLAN 3D** invisible hinge was designed to be hidden within the structure of a door or panel, offering both aesthetic appeal and advanced functionality.

These hinges are often used in high-end cabinetry, modern architecture, and sleek furniture designs where a clean, uninterrupted look is desired.

As the name suggests, the hinge is typically "invisible" from the exterior, providing a seamless visual appearance.

The key feature is its ability to pivot in multiple directions.

Unlike traditional hinges, which only allow for rotation around a single axis, a 3D hinge can offer three types of adjustment: height adjustment, side-to-side adjustment and depth adjustment.

Our **COPLAN 3D** invisible hinge can elevate the overall look and functionality of your space.

COPLAN SERIES

3D INVISIBLE HINGE



4x **18kg**
3x **14kg**
2x **10kg**

IN.05.067 > COPLAN 75

RAL 9006 RAL 9005



3x **50kg**
2x **30kg**

IN.05.066 > COPLAN 100

RAL 9006 RAL 9005

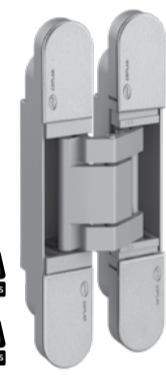

3x **60kg**
2x **40kg**

IN.05.065 > COPLAN 145

RAL 9006 RAL 9005



FIREPROOF
3x **80kg**
2x **50kg**

IN.05.064 > COPLAN 120

RAL 9006 RAL 9005 RAL 9016
COPPER GOLD

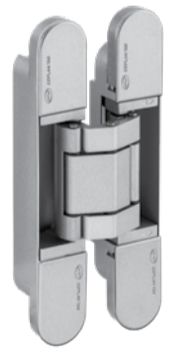

FIREPROOF
3x **80kg**
2x **50kg**

IN.05.061 > COPLAN 150

RAL 9006 RAL 9005 RAL 9016
COPPER GOLD

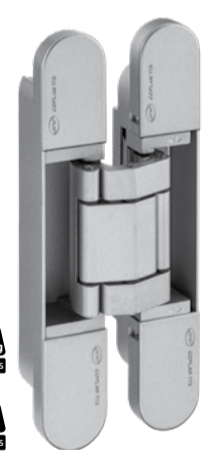

FIREPROOF
3x **120kg**
2x **80kg**

IN.05.062 > COPLAN 175

RAL 9006 RAL 9005 RAL 9016
COPPER GOLD



FIREPROOF
3x **150kg**
2x **130kg**

IN.05.063 > COPLAN 245

RAL 9006 RAL 9005 RAL 9016
COPPER GOLD

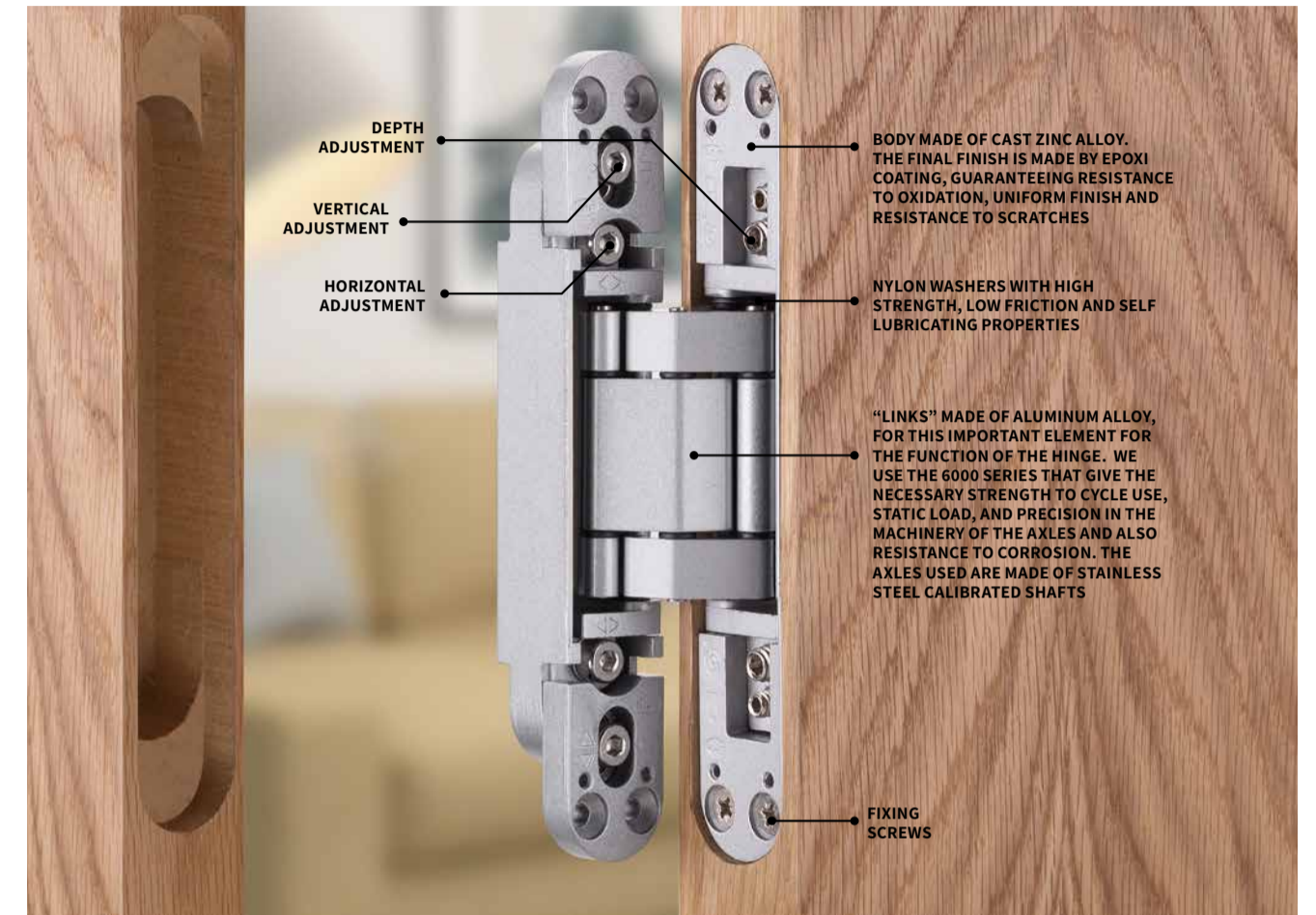





IN.05.06_C
STAINLESS STEEL COVERS



IN.05.06_C.TB
STAINLESS STEEL COVERS WITH PVD TITANIUM BLACK FINISH



IN.05.06_C.TG
STAINLESS STEEL COVERS WITH PVD TITANIUM GOLD FINISH



IN.05.06_C.TCO
STAINLESS STEEL COVERS WITH PVD TITANIUM COPPER FINISH



COPLAN POWER GUIDE

ALLOWS TO PASS WIRES

COPLAN POWER GUIDE allows to pass wires from the frame to the door, keeping same concept of the concealed hinges. The cables are protected by articulated plastic guide, avoiding cables to brake or be accessible from the outside.

This system was designed to be easy to install and to pass the cable through, which can go till 6mm diameter. Doesn't require special cables or plugs, as the cable can be complete without connections.

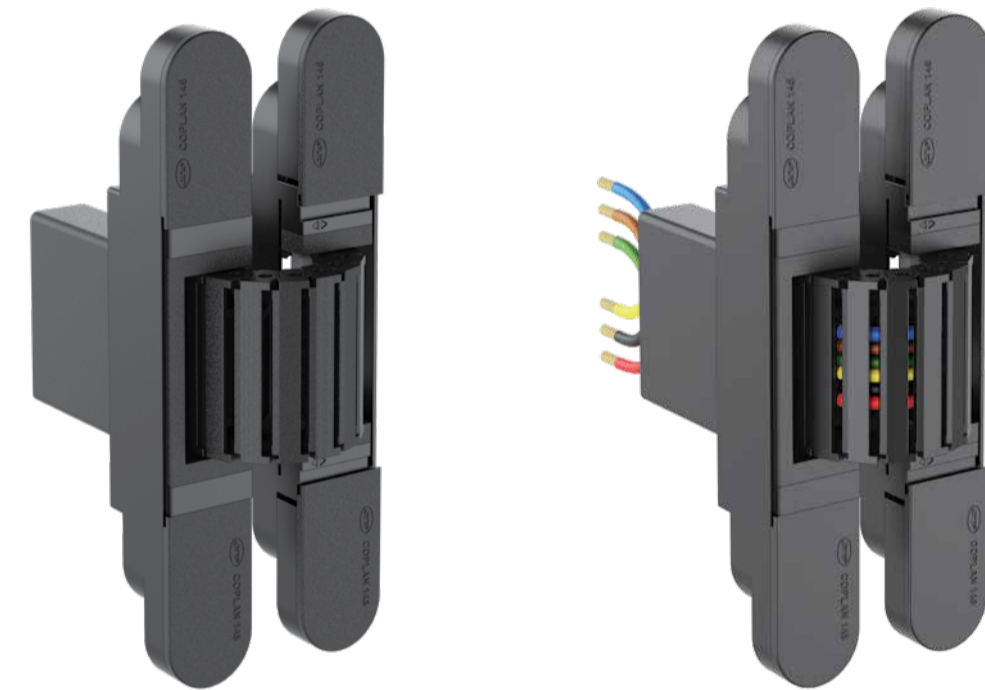

AVAILABLE IN:

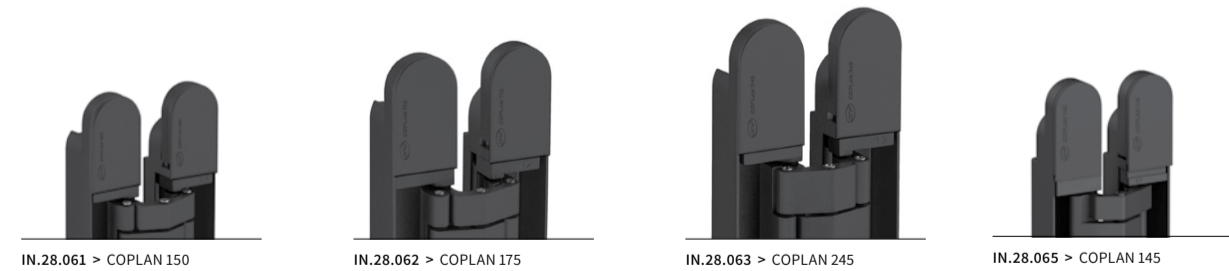

IN.28.061 > COPLAN 150

IN.28.062 > COPLAN 175

IN.28.063 > COPLAN 245

IN.28.065 > COPLAN 145



DIN LOCK SERIES

ONE BODY, ENDLESS POSSIBILITIES

Unified body design: A robust, streamlined structure compatible with multiple latch types for versatile applications.

Heavy-Duty grade 3 durability: Engineered for high-traffic environments, ensuring long-lasting performance and reliability.

Magnetic, silent and gap-canceling mechanism: Experience seamless operation with reduced noise and enhanced door alignment.

Concealed front plate screws: A refined minimalist aesthetic that complements modern interiors.

Comprehensive functionality: Available in all key configurations, including cylinder, bathroom, passage, and standard key systems.

Premium finishes: Optional PVD titanium coatings in various finishes for superior durability and a refined look.

Compatible with 'Less is More' and springless roses: Ideal for achieving a minimalist, elegant appearance while maintaining top-notch functionality.

The **DIN LOCK SERIES** is the ultimate solution for those who demand both performance and design excellence.

DIN LOCK SERIES

ONE BODY, ENDLESS POSSIBILITIES

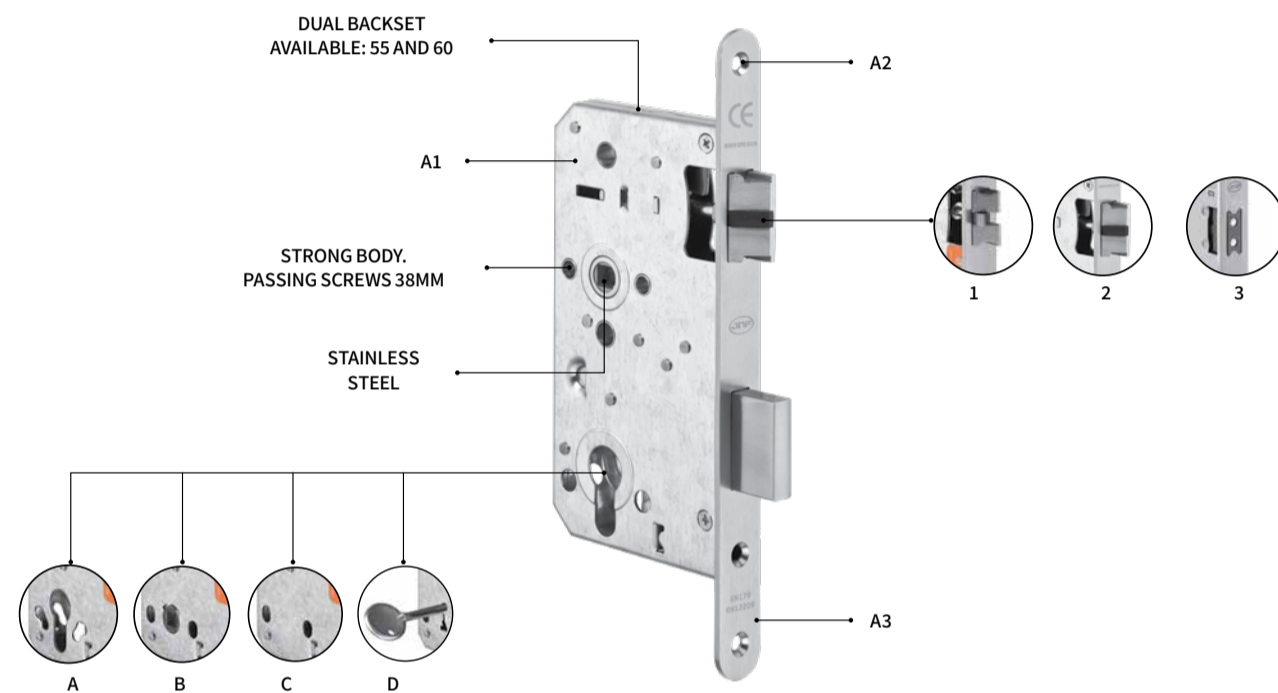

030

A1 - Unified body design: A robust, streamlined structure compatible with multiple latch types for versatile applications.

Heavy-Duty grade 3 durability: Engineered for high-traffic environments, ensuring long-lasting performance and reliability.

Magnetic, silent and gap-canceling mechanism: Experience seamless operation with reduced noise and enhanced door alignment.

A2 - Concealed front plate screws: A refined minimalist aesthetic that complements modern interiors.

Comprehensive functionality: Available in all key configurations, including cylinder, bathroom, passage, and standard key systems.

A3 - Premium finishes: Optional PVD titanium coatings in various finishes for superior durability and a refined look.

Compatible with 'Less is More' and springless roses: Ideal for achieving a minimalist, elegant appearance while maintaining top-notch functionality.

The **DIN LOCK SERIES** is the ultimate solution for those who demand both performance and design excellence.

031

1

Stainless steel latch with anti-gap and anti-movement design.

Engineered to eliminate unsightly gaps and prevent unwanted door movement for a secure and polished finish. Made from high-grade stainless steel, ensuring long-lasting strength and resistance to wear and corrosion. Maintains a tight, precise fit between the door and frame, reducing noise and improving functionality. Designed for a clean and seamless look, complementing contemporary interiors. Smooth and consistent operation, perfect for residential and commercial applications.

2

Silent stainless steel latch with polymer technology.

Features advanced polymer components to ensure smooth and silent functionality, perfect for noise-sensitive environments. Combines durable stainless steel with technical polymer materials for enhanced wear resistance and longevity. Designed to deliver exceptional performance without compromising on aesthetics. The polymer components minimize friction, ensuring consistent and effortless operation over time. Ideal for residential, commercial, and hospitality applications, offering a premium, noise-free solution.

3

High-Tech polymer magnetic latch

Crafted entirely from high-tech polymer, delivering exceptional durability, lightweight performance, and corrosion resistance. Utilizes a powerful magnetic mechanism for smooth, noise-free door closure without the need for mechanical parts. A sleek design that complements contemporary interiors with clean, seamless functionality. Resistant to wear, ensuring reliable operation even in high-traffic environments. Lightweight and designed for effortless setup, making it ideal for a wide range of applications.

A

European cylinder type for DIN lock

Designed to accommodate European profile cylinders, providing flexibility for a variety of locking solutions

C

Passage type DIN Lock

Designed for doors that require passage functionality without locking, ideal for connecting spaces like hallways and living areas. Fully compatible with DIN lock cases for universal application and easy installation.

D

DIN lock with standard key function and 12 combinations

Designed for secure locking and unlocking using a traditional key, ideal for a variety of applications. Offers multiple keying options to enhance security and versatility for residential, commercial, or office spaces. Fully compatible with DIN lock cases, ensuring seamless integration and easy installation.

B

WC function in DIN Lock

Fully compatible with all JNF bathroom indicator sets, ensuring seamless integration and a perfect fit. Features a snib mechanism for effortless locking and unlocking, providing a reliable solution for bathroom doors. Includes an external override function for added safety, allowing access in case of emergencies.

MAGNACORE

STRENGTH IN SILENCE, POWER IN PRECISION

Heavy-Duty grade 3 performance: Built for the toughest environments, ensuring reliability in high-traffic areas.

Centered magnetic latch: Provides precise alignment for smooth, effortless operation and enhanced durability.

Invisible screw design: A clean, seamless look for modern interiors and minimalist aesthetics.

Adjustable angle mechanism: Customizable angle to accommodate heavy handles, with fine-tuning via angle adjustments for optimal functionality.

Flexible key options: Available in normal key or bathroom versions for enhanced versatility.

Premium finishes: PVD titanium coating options offer a wide range of elegant and durable finishes to suit any design.

Discrete and powerful: Combines subtle design with uncompromising strength for a lock that performs without drawing attention.

The perfect choice for those seeking a sleek yet powerful magnetic locking solution that seamlessly integrates style and functionality.



IN.20.865
GRADE 3 MAGNETIC MORTISE LOCK FOR BATHROOM AND / OR NORMAL KEY.

MAGNALITE

STRENGTH IN SIMPLICITY, LIGHT IN DESIGN

Grade 2 performance: Built for domestic and private environments.

Centered magnetic latch: Provides precise alignment for smooth, effortless operation and enhanced durability.

Invisible screw design: A clean, seamless look for modern interiors and minimalist aesthetics.

Comprehensive functionality: Available

in all key configurations, including cylinder, bathroom, passage, and standard key systems.

Premium finishes: PVD titanium coating options offer a wide range of elegant and durable finishes to suit any design.

Discrete and powerful: Combines subtle design with uncompromising strength for a lock that performs without drawing attention.



EUROPEAN CYLINDER

BATHROOM

NORMAL KEY

034



FLAT LOCK SET
LOCK FOR RESIDENTIAL USE

035



**FLAT LOCK +
MAGSTRING LATCH**
SIMPLE, SECURE AND SLEEKLY CONCEALED



036

FLAT LOCK SET

LOCK FOR RESIDENTIAL USE

The perfect fusion of the handle with the door. The cleanliness of the design frame combined with the low noise action brings out the **FLAT** lock.

Lock with handle coplaned with the door. The handle is almost hidden, working by pressure, when activated, an element is projected that serves to pull the door.

The lock has a mechanism that allows the built-in shell system to maximum projection inwards.

The new JNF concealed lock is the perfect fit for your project. With a wide range of different materials and finishes, and the possibility of mixing both, you can create your own design. The attention to details became our focus.

The lock features a silent, smooth latch, enabling the recessed handle system to achieve maximum inward projection, enhancing ergonomics and user comfort.

Its advanced trifold latch design stands out as one of the best solutions for achieving low-effort, smooth door opening, providing a seamless and efficient user experience.

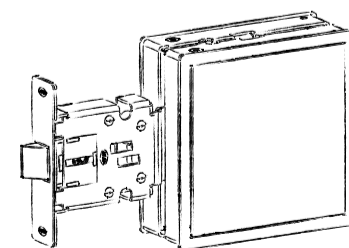

037

MAGSTRING LATCH

SIMPLE, SECURE AND SLEEKLY CONCEALED

The **MAGSTRING** latch combines effortless operation with advanced design.

Featuring a magnetic mechanism operated by a durable rope, it ensures smooth and intuitive functionality while prioritizing safety with easy emergency access from the outside when needed.

Designed for flat and concealed applications,

this latch seamlessly integrates into any environment, maintaining a clean, minimalistic look without compromising performance. Produced in stainless steel or premium PVD titanium finishes in various colors, it offers both versatility and style to match any design vision.

The perfect choice for those who value simplicity, security and seamless aesthetics.

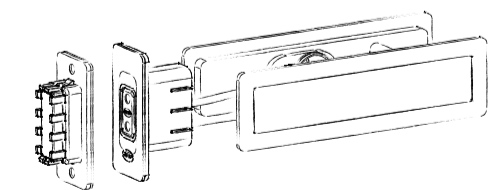
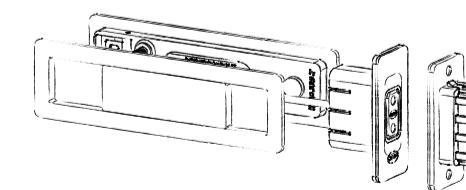

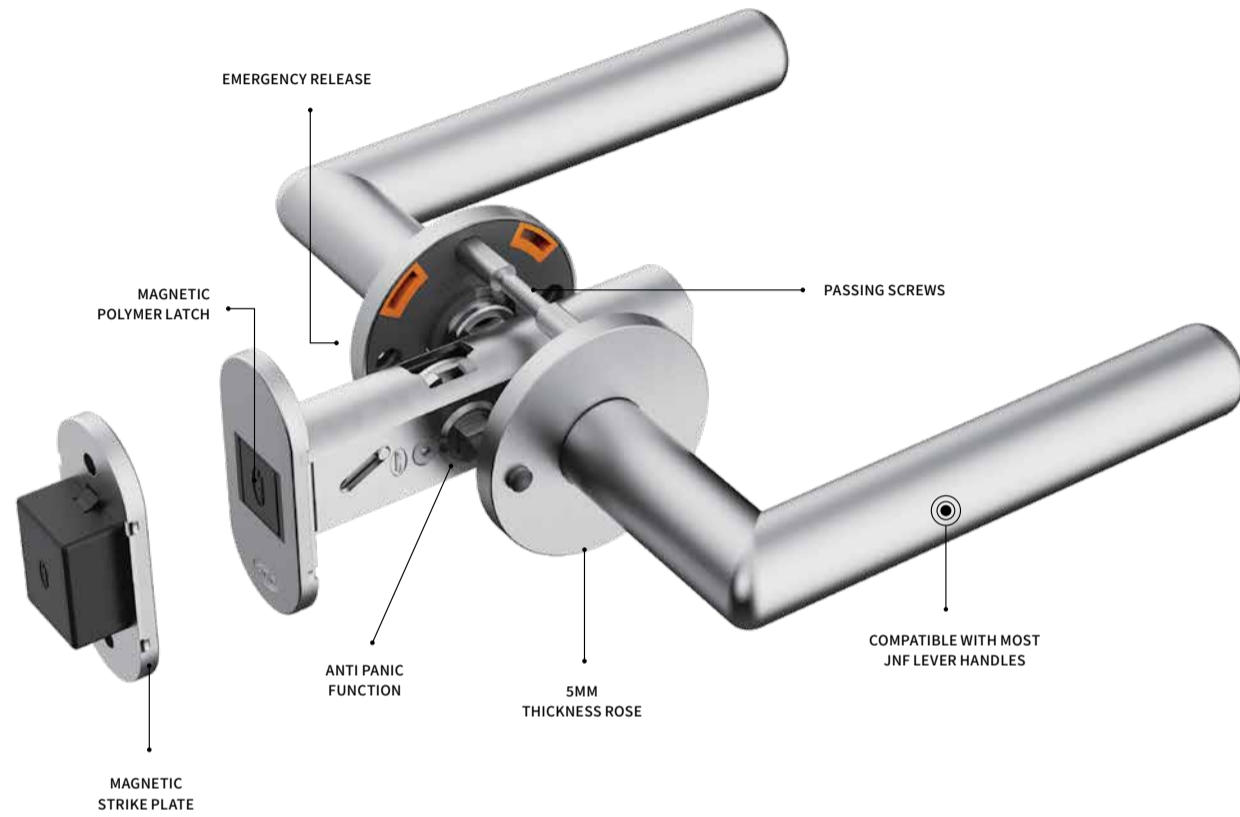

038

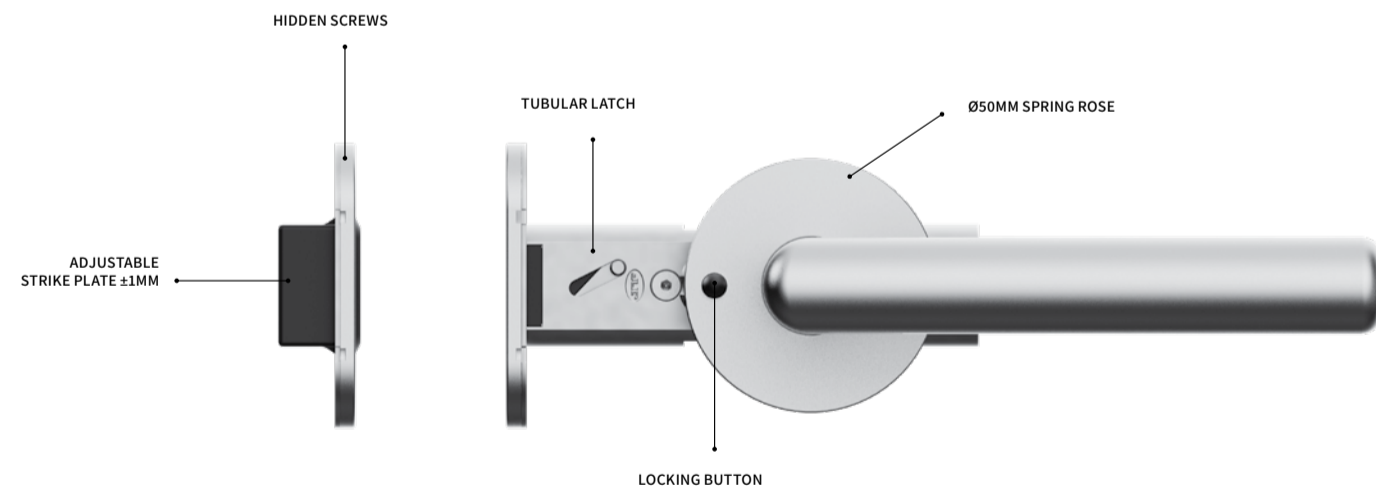

IN.20.165.GCP + IN.00.180.SR.GCP

039

PULSELOCK

PRECISION SAFETY AT A TOUCH

Revolutionary anti-panic design: The locking mechanism is seamlessly integrated into the rose for ultimate simplicity. Lock securely with a press, and unlock instantly by pushing down the handle—providing intuitive, quick exit.

Magnetic latch made of polymer: Designed for silent and smooth operation, the high-performance polymer latch ensures a seamless user experience while reducing noise and wear.

Emergency access from outside: In critical situations, the lock can be easily unlocked using a simple tool, prioritizing safety without compromising the privacy.

Versatile compatibility: Perfectly designed to pair with most JNF lever handles, offering flexibility and style for a wide range of interior applications.

Elegant stainless steel plates: Front and strike plates crafted from stainless steel conceal screws for a modern, minimalist look. Optional PVD titanium finishes in various colors add durability and sophistication.

Unified, minimalist design: This system merges the lock, handle, and rose into a single, streamlined solution, delivering a clean, contemporary aesthetic.



IN.20.166 + IN.00.028.RC08M

SMOOTH CLOSE LATCH

EASY TO INSTALL AND SILENT

Smooth and silent operation: The magnetic mechanism ensures quiet closing and opening, ideal for modern interiors.

Universal backset: 60mm backset with passing screws for a strong and secure fixation of lever handles.

Concealed design: Front and strike plates feature hidden screws, offering a sleek and seamless appearance.

Versatile compatibility: Perfectly designed to pair with most JNF lever handles, offering

flexibility and style for a wide range of interior applications.

Premium material: Made of durable stainless steel with the option for PVD titanium finish, available in various colors to suit your style.

Effortless installation: Designed for hassle-free setup, perfect for both new builds and renovations.

Upgrade your doors with a reliable, elegant, and silent magnetic tubular latch.

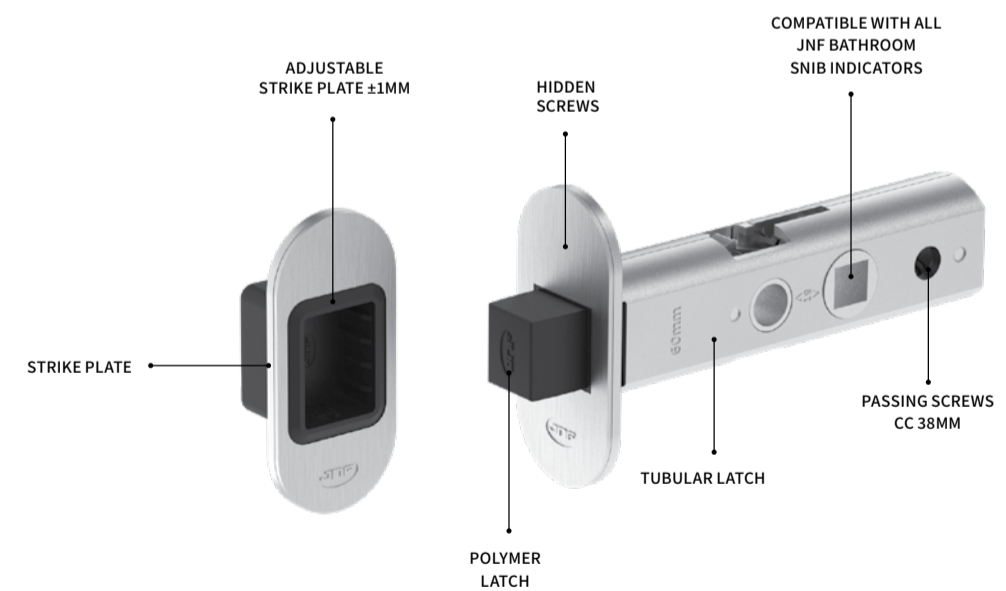



SNIB SECURE BOLT

TURN 90 DEGREES TO TOTAL PEACE OF MIND

Versatile compatibility: Designed to work seamlessly with JNF's wide range of bathroom snib indicators, providing stylish and functional locking solutions.

Easy installation: Quick and straightforward to install, making it ideal for both professionals and DIY projects.

Effortless operation: A simple 90-degree turn locks or unlocks the door with ease, ensuring smooth usability.

Upgrade your bathroom doors with a reliable, easy-to-use deadbolt latch that complements JNF's extensive indicator range.

Flexible use: Can be combined with other tubular latches for a complete and cohesive door hardware setup.

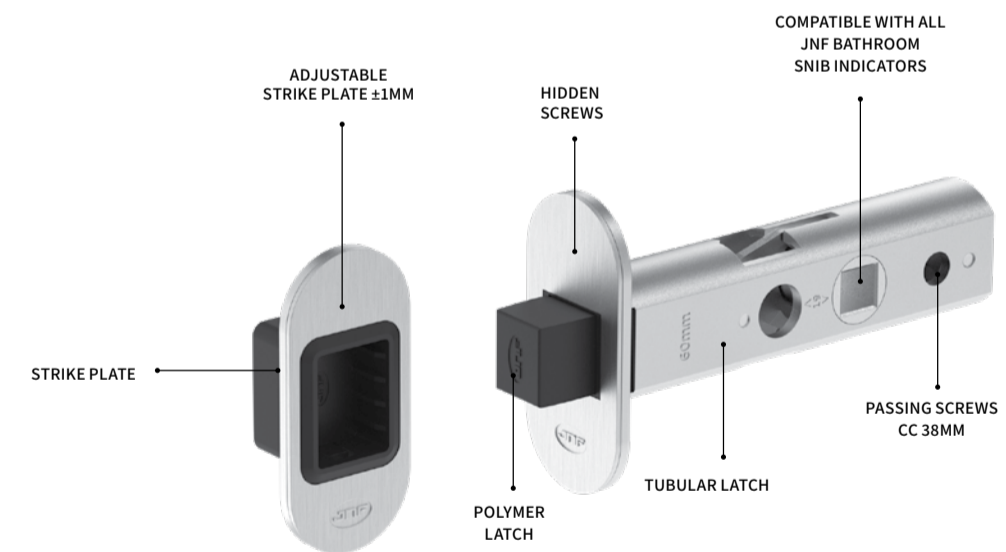



IN.00.180.TB + IN.04.207.TB + IN.19.B15.TB

044

An essential accessory to use with mortise locks, bathroom snib indicators that combines privacy, security and safety with ergonomic design.

Designed to allow the door to be locked from the inside, they ensure privacy while offering the ability to open the door from the outside in case of an emergency.

The ergonomic design of the buttons ensures effortless operation, providing ease of use and comfort, even in tight spaces. Perfect for bathrooms, changing rooms, and other areas where privacy is essential but safety remains a top priority.

Privacy when you need it. Safety when it matters. Ergonomics at your fingertips.

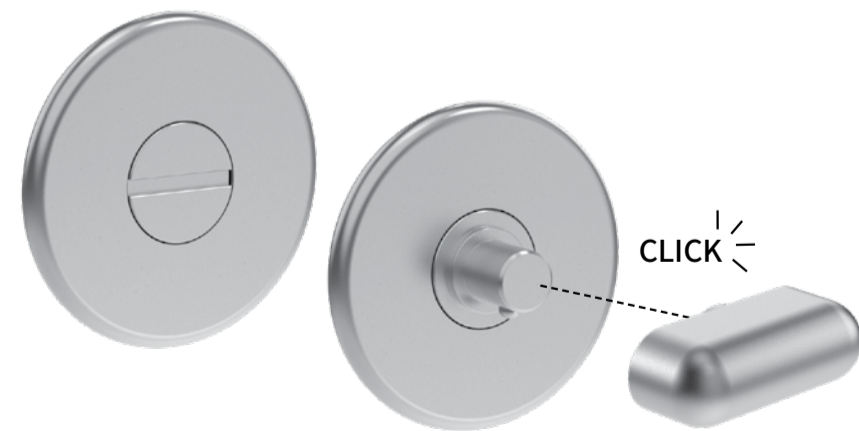

BATHROOM SNIB INDICATORS

PRIVACY WHEN YOU NEED IT



IN.04.401
BATHROOM SNIB WITHOUT COLOR INDICATOR
Ø50x13mm



IN.04.402
BATHROOM SNIB WITHOUT COLOR INDICATOR
Ø50x13mm



IN.04.209
BATHROOM SNIB WITHOUT COLOR INDICATOR
Ø50x8mm



IN.04.200
BATHROOM SNIB WITH COLOR INDICATOR
Ø50x8mm



IN.04.204
BATHROOM SNIB WITHOUT COLOR INDICATOR
Ø50x5mm



IN.04.201
BATHROOM SNIB WITH COLOR INDICATOR
Ø50x5mm



IN.04.207 COOL SERIES
BATHROOM SNIB WITHOUT COLOR INDICATOR
Ø50x5mm



IN.04.208
BATHROOM SNIB WITHOUT COLOR INDICATOR
Ø28x3mm

045



SLIDING DOOR LOCK SOLUTIONS

BY JNF

Comprehensive range: JNF offers the largest range of sliding door lock solutions, catering to all types of sliding door applications with unmatched versatility.

Sleek and seamless design: Features a front plate with no visible screws, delivering a clean and modern aesthetic perfect for contemporary interiors.

High-quality craftsmanship: Designed with precision and built using premium materials for durability, functionality and style.

Effortless integration: Suitable for a wide variety of sliding doors, ensuring compatibility and easy installation.

Innovative and reliable: Combining sleek looks with advanced locking technology, providing both elegance and security.

Finishes: Black (RAL 9005), White (RAL 9016) and stainless steel.

Choose JNF for sliding door locks that combine cutting-edge design with the industry's widest range of solutions.



SLIDING DOOR LOCK SOLUTIONS

BY JNF



IN.20.937.B
MORTISE DOOR LOCK FOR SLIDING DOORS WITH ROUND FLUSH HANDLE.
FINISH: BLACK



IN.20.938.B
MORTISE DOOR LOCK FOR SLIDING DOORS WITH SQUARE FLUSH HANDLE.
FINISH: BLACK



IN.20.939
MORTISE DOOR LOCK FOR SLIDING DOORS WITH ROUND FLUSH HANDLE
AND COLOR INDICATOR.



IN.20.940
MORTISE DOOR LOCK FOR SLIDING DOORS WITH ROUND FLUSH HANDLE
AND COLOR INDICATOR.



Comprehensive range: JNF offers the largest range of sliding door lock solutions, catering to all types of sliding door applications with unmatched versatility.

Sleek and seamless design: Features a front plate with no visible screws, delivering a clean and modern aesthetic perfect for contemporary interiors.

High-quality craftsmanship: Designed with precision and built using premium materials for durability, functionality and style.

Effortless integration: Suitable for a wide variety of sliding doors, ensuring compatibility and easy installation.

Innovative and reliable: Combining sleek locks with advanced locking technology, providing both elegance and security.

Choose JNF for sliding door locks that combine cutting-edge design with the industry's widest range of solutions.





IN.00.145.LN + IN.04.204 + IN.19.B8.LN

050

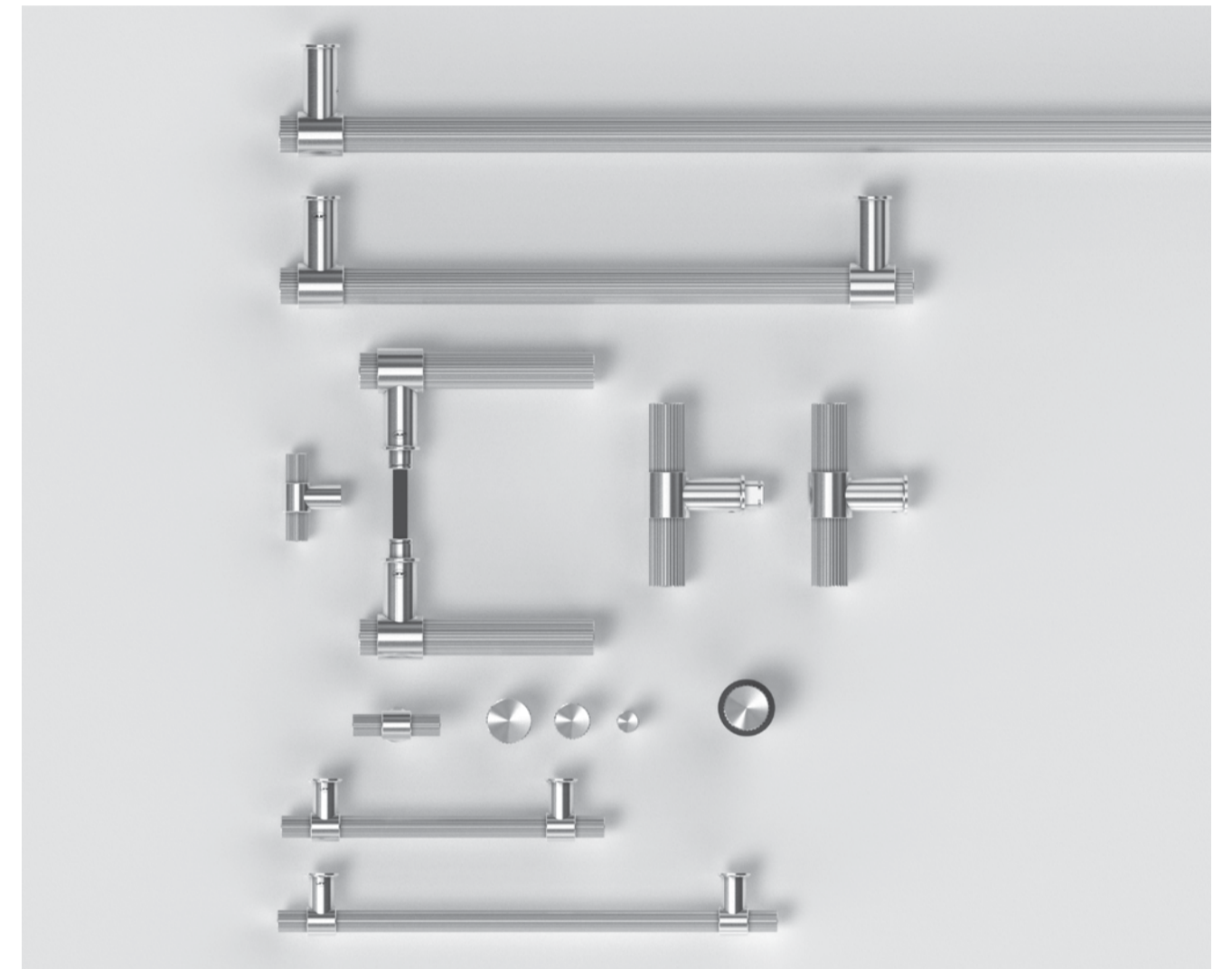

051

NATUR LINEA

A TRIBUTE TO TIMELESS ELEGANCE

Drawing inspiration from the grandeur of Greek architecture and the opulence of the Corinthian style, this collection fuses classical beauty with modern functionality.

These handles reflect the same sense of luxury and meticulous craftsmanship. Every curve, every contour, is thoughtfully designed to evoke the same sense of timeless beauty.

Rooted in the rich history of ancient Greece, where architectural elements spoke of refinement, power, and divine order, these lever handles embody the elegance of Corinthian columns—recognized for their intricate detailing and design.

Their graceful forms, paired with fine detailing, effortlessly blend classical inspiration with contemporary appeal, making them ideal for both modern and traditional interiors.



IN.00.145.LN.RGO

LINEA COLORS

A SOPHISTICATED COLOR PALETTE

The **NATUR LINEA COLORS** collection is a stunning array of handles designed to blend form and function with a sophisticated color palette.

Each handle in this collection is thoughtfully crafted to add a distinctive aesthetic to any interior space.

Featuring a spectrum of refined hues, the collection includes: Boreal Blue, Mud Brown, Green Oxid, Aged Red, Black and White, ideal for adding a fresh and minimalistic touch to your interiors.





SIMPLE COLLECTION

BY LYDIA KÜMEL

The **SIMPLE** Collection is a timeless tribute to functional design and European heritage, originally designed by Lydia Kümel in 1990's.

Drawing inspiration from the robust, ergonomic handles of Belgian train carriages, this collection merges industrial charm with modern elegance.

Resumed by JNF, the collection has been expanded to include versatile solutions tailored for furniture and bath collections.

Each handle embodies the meticulous craftsmanship and durability that defined the original design, now with several products and finishes.



ACRYLIC VINTAGE PLATE

CLEAR & COLORFUL DESIGN





EDGE FLOW

NEW COLLECTION

Explore the perfect balance of form and function with our **EDGE FLOW** collection.

Crafted to complement a variety of design styles, this collection offers versatile pieces that can elevate both modern and classic interiors.

Whether you're updating furniture, enhancing architectural features, or adding the finishing touch to cabinetry, these hardware pieces bring timeless elegance to any space.

Sleek and minimalist, our hardware offers a clean, streamlined look.

Perfect for adding a bit of contrast to angular or geometric design elements, it brings a tactile and inviting quality to any room.

Ideal for contemporary designs or spaces that call for simplicity, fitting seamlessly with minimalist aesthetics.

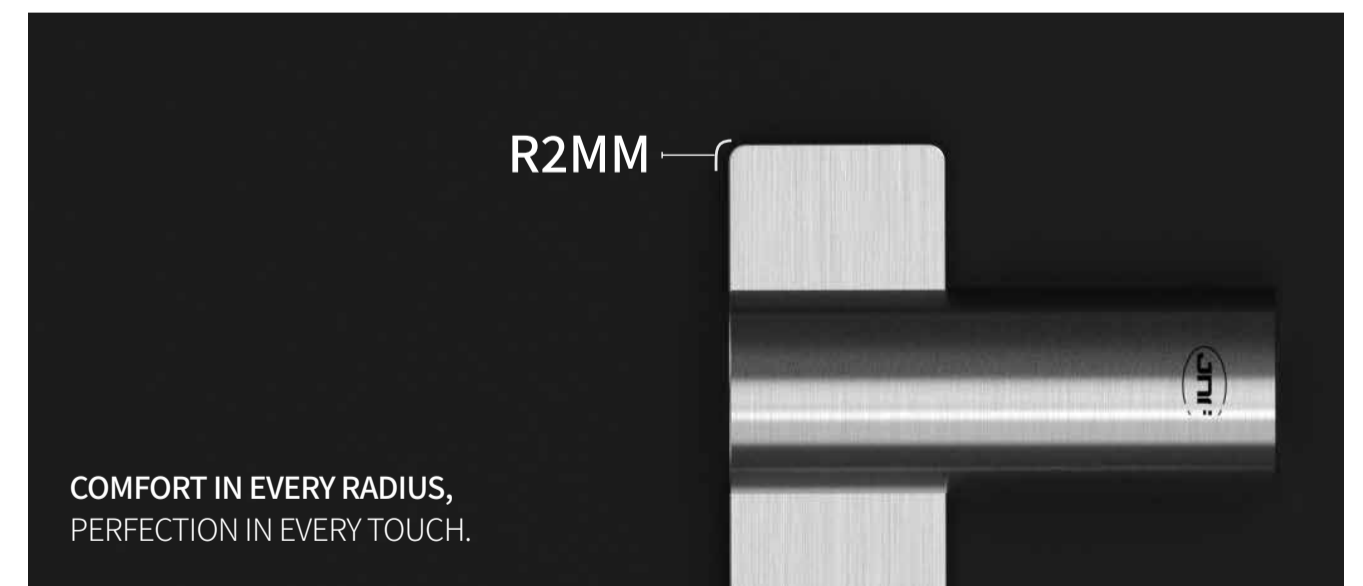
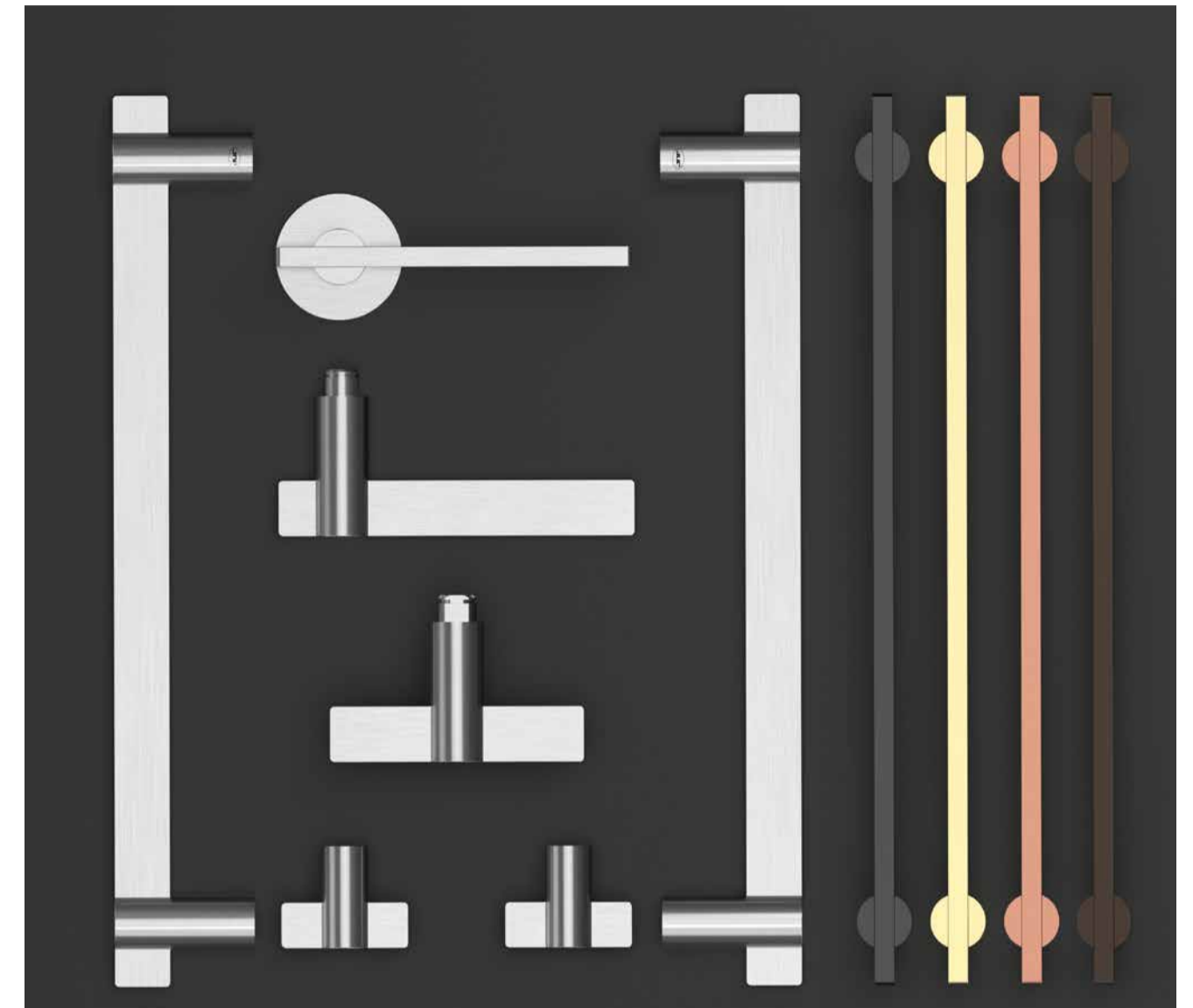



IN.00.177

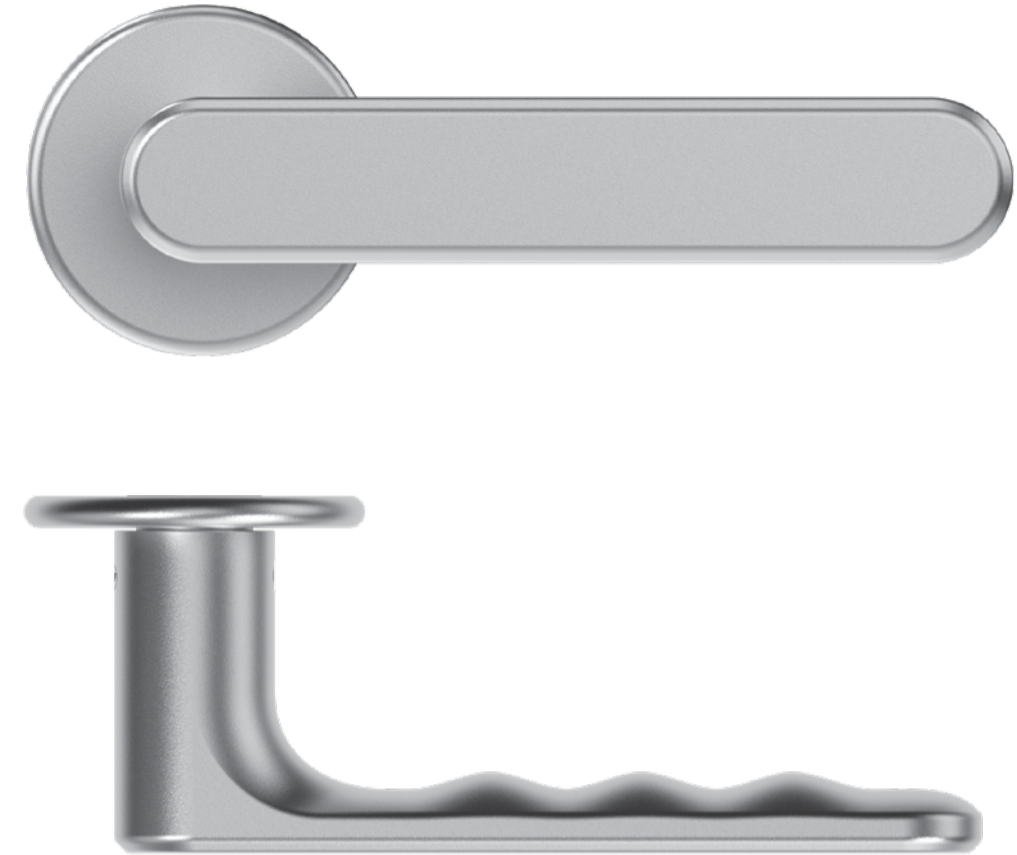

IN.00.175

TOKYO

LEVER HANDLE COLLECTION

Drawing inspiration from the dynamic blend of traditional and contemporary design in Tokyo's architecture, this exclusive lever handle collection embodies the city's unique fusion of innovation, heritage, and nature.

Crafted with ergonomic precision, each handle ensures a comfortable, intuitive grip, while its organic forms evoke the harmonious balance between Tokyo's sleek, modern skyline and the flowing lines found in nature.

The collection reflects the minimalist elegance and bold geometry of the city, where glass facades meet historical structures, seamlessly blending modernity with timeless grace.

These handles offer a tactile and aesthetic experience that merges functionality with sophisticated design.

GREAT TOKYO

INNOVATIVE DESIGN. MODERN TOUCH. UNMATCHED DURABILITY.

Inspired by the elegance of our TOKYO model, the **GREAT TOKYO** offers a larger, more robust design, making it the perfect choice for high-traffic areas and public spaces.

With its sleek, modern aesthetics and ergonomic design, it combines style, durability, and superior functionality.

Experience the elegance of our latest innovation — Grain Finish on stainless steel. This cutting-edge technique creates a smooth, fine-grain

texture that offers a modern, sophisticated look while maintaining durability and resistance.

This unique process enhances the surface with a soft, matte appearance, providing an understated yet refined finish perfect for high-end hardware applications.

This brand-new surface option combines style, functionality, and versatility, elevating your space with a clean and contemporary aesthetic.

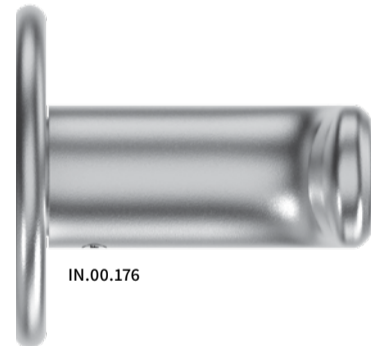

IN.00.176

Designed for comfort: The back shape features a contoured design with dedicated space to naturally fit your fingers, ensuring a comfortable grip every time.

Enhanced ergonomics: Perfectly crafted to reduce hand fatigue and provide an effortless, secure hold.

Elegant and functional: Combines modern design with exceptional usability, making it ideal for both residential and commercial spaces.

Durable quality: Built with premium materials to ensure long-lasting performance and style.

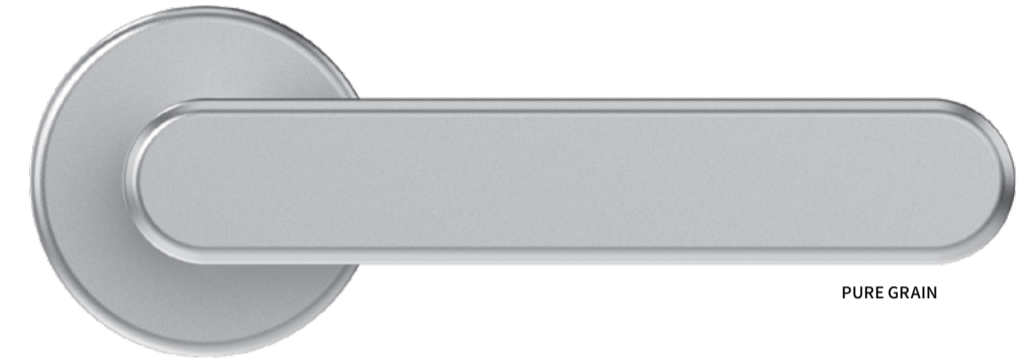

PURE GRAIN



GRAIN BLACK

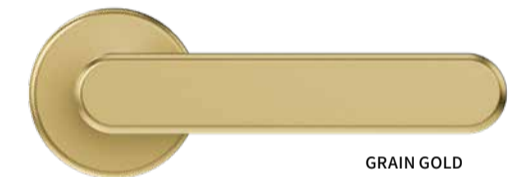

GRAIN GOLD

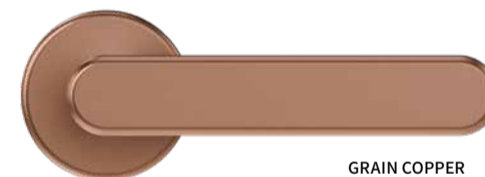

GRAIN COPPER



GRAIN CHOCOLATE

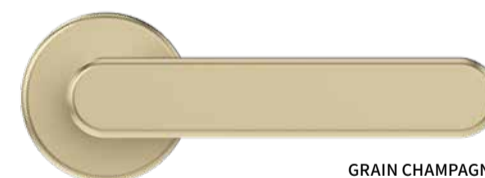

GRAIN CHAMPAGNE

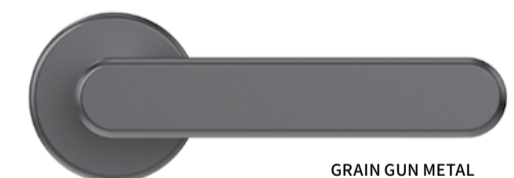

GRAIN GUN METAL



IN.00.392
FIXED DOOR KNOB
FINISH: RAW

IN.00.391
FIXED DOOR KNOB
FINISH: RAW

INDUSTRIAL DESIGN

NEW SERIES

Embrace the industrial allure of our newer collection meticulously developed to redefine your spaces with a robust and timeless aesthetic. Inspired by the enduring charm of old industrial plumbing systems, each piece in this collection exudes an unmistakable rugged elegance.

The design pays homage to the durability and character of vintage plumbing, bringing forth an industrial look that seamlessly blends with contemporary settings.

Produced with meticulous attention to detail, our handles and knobs beautifully combine both form and function. The collection is characterized by its sturdy construction, invoking the essence of robustness found in industrial settings.

The handles are not just accessories; they are a statement – a tribute to the enduring quality of craftsmanship. This collection is more than just a design choice; it's an investment in enduring quality, reflecting the resilience of industrial heritage.

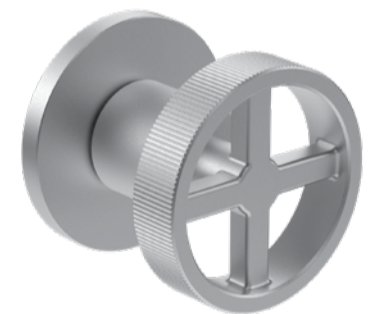
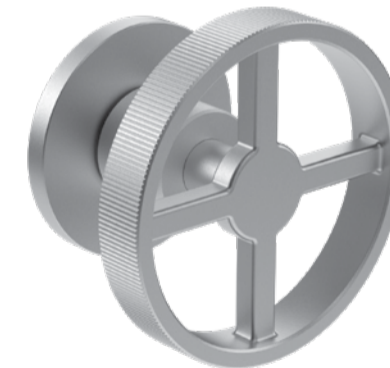

IN.00.216.PR
ROTATING DOOR KNOB
FINISH: PURE GRAIN

IN.00.215.PR
ROTATING DOOR KNOB
FINISH: PURE GRAIN



IN.00.390.R
DOOR LEVER HANDLE WITH ROSE
FINISH: RED LACQUER



IN.00.390
DOOR LEVER HANDLE WITH ROSE
FINISH: SATIN



IN.00.390.TB
DOOR LEVER HANDLE WITH ROSE
FINISH: PVD TITANIUM BLACK



IN.00.390.TG
DOOR LEVER HANDLE WITH ROSE
FINISH: PVD TITANIUM GOLD



IN.00.390.TCO
DOOR LEVER HANDLE WITH ROSE
FINISH: PVD TITANIUM COPPER



IN.00.390.TCH
DOOR LEVER HANDLE WITH ROSE
FINISH: PVD TITANIUM CHOCOLATE



IN.07.390
DOOR PULL HANDLE
FINISH: SATIN



IN.07.390.TB
DOOR PULL HANDLE
FINISH: PVD TITANIUM BLACK



IN.07.390.TG
DOOR PULL HANDLE
FINISH: PVD TITANIUM GOLD



IN.07.390.TCO
DOOR PULL HANDLE
FINISH: PVD TITANIUM COPPER



IN.07.390.TCH
DOOR PULL HANDLE
FINISH: PVD TITANIUM CHOCOLATE

LOFT SERIES

STYLE, INNOVATION & COMFORT

Introducing the latest collection of pull handles, where functionality meets elegance.

This new range includes an expanded selection of sizes, cutting-edge features, and a smooth, tactile finish that sets a new standard in door hardware design.

Crafted for those who appreciate both form and function, these pull handles provide a perfect blend of aesthetics, comfort, and durability.

Each handle is designed to enhance your space with minimalist lines and a clean aesthetic. The collection includes a variety of styles, from contemporary to more classic forms, ensuring a seamless integration with both traditional and modern décor.

These handles provide a luxurious look that will complement any door.



IN.07.184.D.900
DOOR PULL HANDLE LOFT
FINISH: SATIN



IN.07.184.D.1800
DOOR PULL HANDLE LOFT
FINISH: SATIN



IN.07.182.D.900
DOOR PULL HANDLE LOFT WITH
FINGERPRINT TECHNOLOGY
FINISH: SATIN



IN.07.182.D.1800
DOOR PULL HANDLE LOFT WITH
FINGERPRINT TECHNOLOGY
FINISH: SATIN

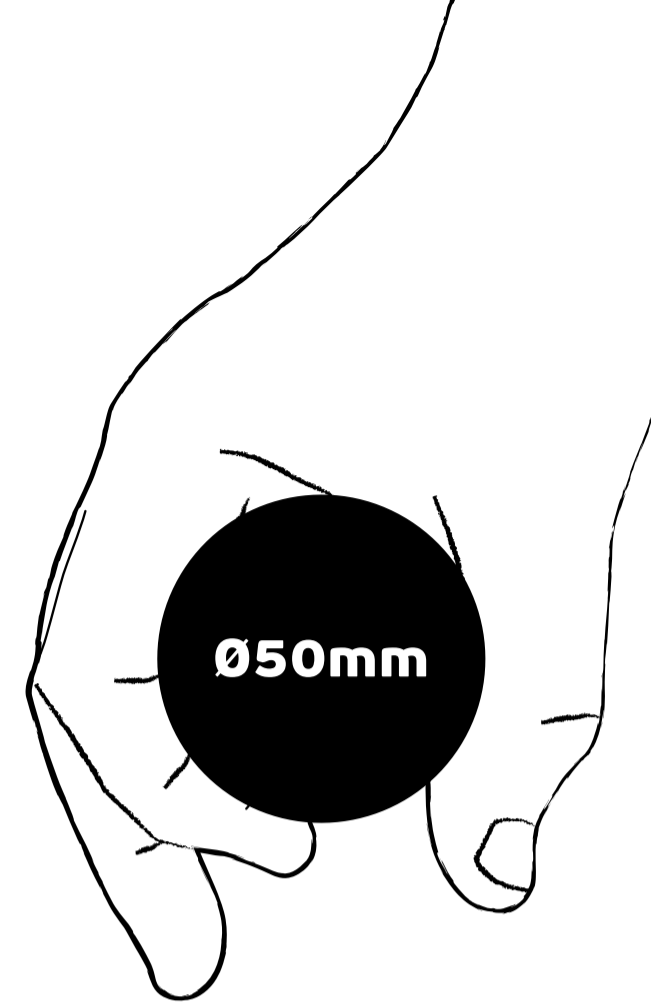

FINGERPRINT TECHNOLOGY

A pull handle with integrated fingerprint technology represents the fusion of security, convenience, and modern design. This innovative door handle allows users to unlock doors or access secured spaces with the simple touch of their fingertip, providing a keyless entry solution that is both sophisticated and highly secure.

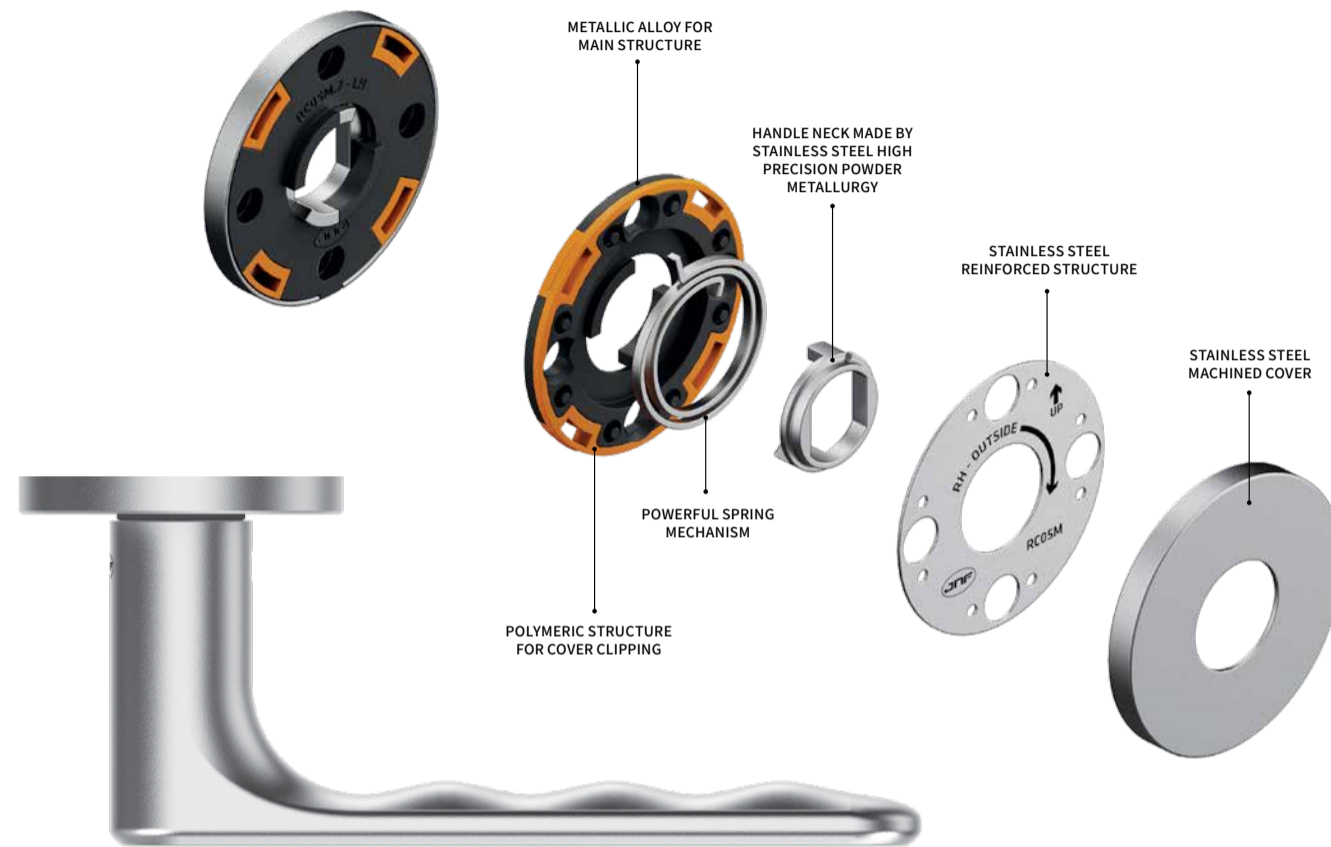

DESIGN ROSE

DIAMETER 50MM, THICKNESS 5MM

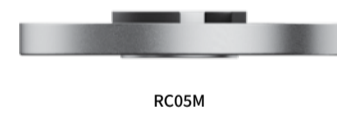

RC05M

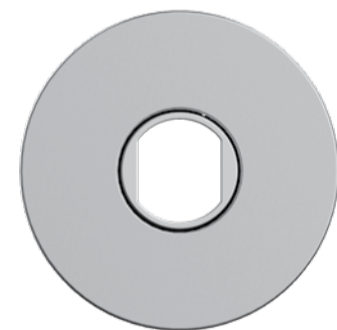

Fully compatible with all JNF handles, ensuring seamless integration and versatility. Designed to support even the heaviest lever handles, maintaining smooth and reliable operation. Tested to withstand 500,000 mechanical cycles, ensuring exceptional longevity.

The rose can be fixed to the handle, creating a reinforced structure for enhanced durability and stability. Minimalist aesthetics with a 50mm diameter and 5mm thickness, offering a clean, modern look without compromising on functionality. Ideal for residential, commercial, and industrial applications where reliability and style are key.

Experience unmatched compatibility and performance with this round rose handle, designed to complement the full range of JNF handles.

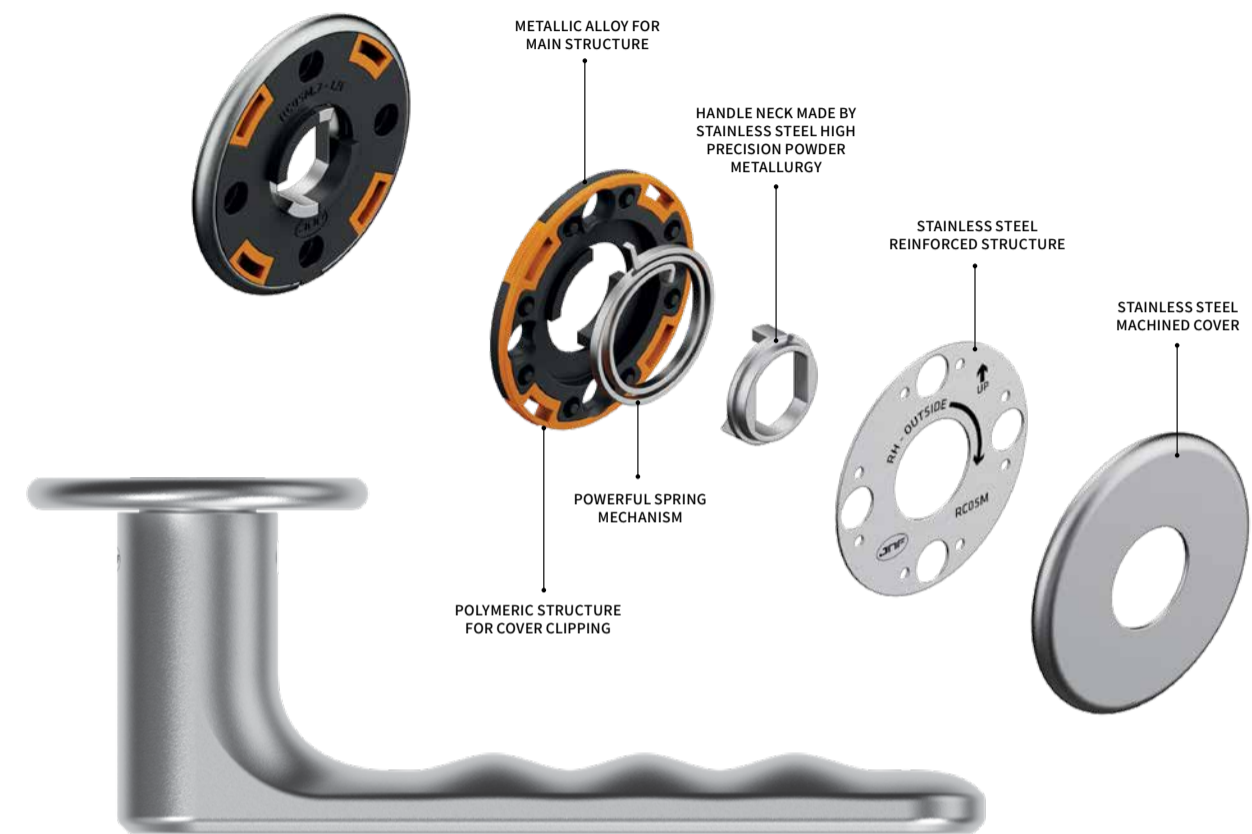

COOL ROSE

REVOLUTIONARY DESIGN WITH PERFECT ROUND EDGE

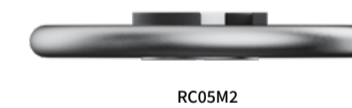

RC05M2

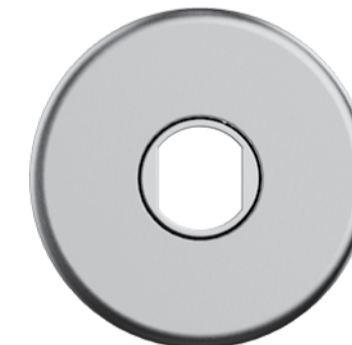

Introducing the **COOL** rose a groundbreaking concept in the ironmongery industry, featuring a solid cover with a perfectly rounded edge for a sleek and modern look. Designed to seamlessly pair with all JNF handles, offering versatility and ease of integration. Built with a powerful spring mechanism to support even heavy handles, ensuring smooth operation and long-lasting performance. Tested to endure 500,000 mechanical cycles, guaranteeing reliability in high-traffic areas.

The rose is securely fixed to the handle, creating a strong, unified structure for enhanced durability. A clean and sophisticated design with a perfectly rounded edge, redefining modern ironmongery aesthetics. Combines style and function with precise dimensions for a harmonious fit.

Step into the future of door hardware with COOL rose, where innovative design meets exceptional performance.



LOVEGROVE x JNF

THREE UNIQUE COLLECTIONS

This partnership represents the fusion of two design powerhouses, combining JNF's engineering expertise with Lovegrove's radical aesthetic vision.

From initial sketches to the final product, each piece in this collection undergoes a rigorous development process. The **LOVEGROVE x JNF** collection is deeply rooted in the principles of biomimicry.

By mimicking nature's most efficient forms and systems, each design not only looks organic but functions in harmony with the environment. This approach allows us to create hardware that is not only aesthetically striking but also engineered for optimal performance.

The forms are born from an exploration of

aerodynamics and organic growth, borrowing shapes from fluid motion, cellular structures, and evolutionary processes. We embrace complexity not only for its aesthetic value but for its ergonomic functionality, ensuring that each piece feels intuitive in the hand, while its sculptural presence enhances any space.

This collection is a testament to the belief that modern design should do more than function—it should inspire. It challenges conventional hardware by fusing art and engineering, leaving behind purely utilitarian principles and entering the realm of crafted sophistication.

By incorporating advanced materials and 3D printing, the collection pushes the boundaries of what architectural hardware can be, combining precision with the beauty of natural flow.

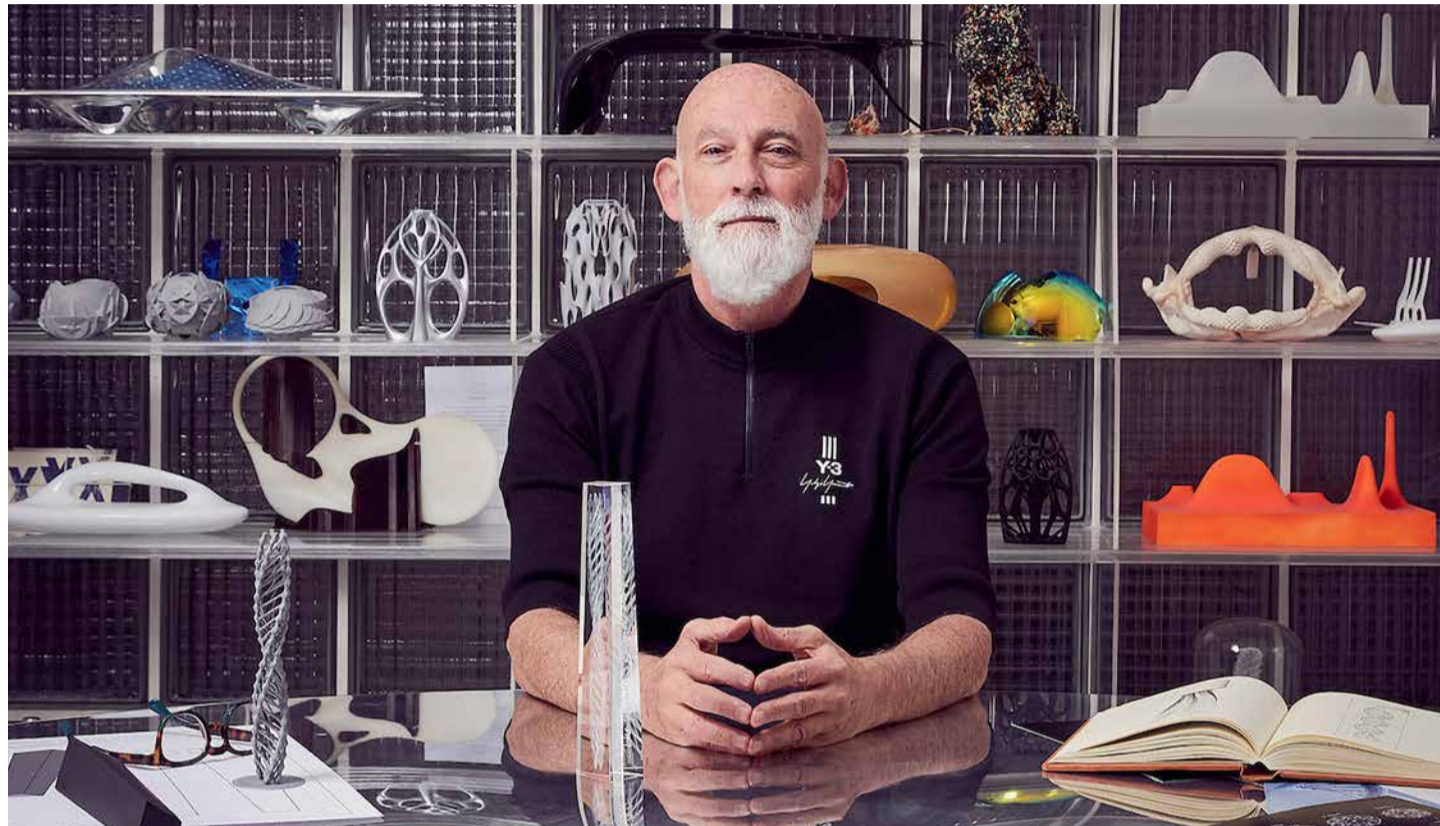

BEHIND THE COLLECTION

ROSS LOVEGROVE

Born 1958, **ROSS LOVEGROVE** graduated from Manchester Polytechnic with 1st Class BA Hons Industrial design in 1980 and took a Master of Design at the Royal College of Art, London in 1983.

In the early 80's worked as a designer for Frog Design in West Germany on tech projects for companies like Sony and Apple; he later moved to Paris as a consultant to Knoll International, for which he created the highly successful Alessandri Office System.

Invited to join the Atelier de Nimes in 1984, alongside with Jean Nouvel and Phillipe Stark, he consulted amongst others: Cacharel, Louis Vuitton, Hermes and Dupont. Returning to London in 1986 he has since worked on projects for Airbus Industries, Kartell, Ceccotti, Cappellini, Moroso, Luceplan, Driade, Peugeot, Apple, Issey Miyake, Vitra, Motorola, Biomega, LVMH, Narciso Rodriguez, Yamagiwa, Tag Heuer, Swarovski, Herman Miller, Artemide, Renault, Japan Airlines, Toyo

Ito Architects, Kenzo, Valextra, GH Mumm, LG, F1, Samsung and KEF.

His work is held in permanent collections of various design museums around the world including the Museum of Modern Art in New York, the Design Museum in London, the Vitra Design Museum in Basel, the Die Neue Sammlung, in Munich and the Centre Pompidou, in Paris.

ROSS LOVEGROVE describes himself as an 'evolutionary biologist' but also a visionary and a sculptor of technology, defining a new genesis of how we can harness the incredible potential of planetary resources to create economic, fat free, lean and efficient products.

He was the first designer to present at TED Global alongside James Watson co-discoverer of DNA, Craig Venter, who mapped the human Genome and, Janine Benyus, the author of Biomimicry.

ROSS LOVEGROVE approached this project with a visionary mindset, leveraging the transformative potential of 3D-printing technology, a production methodology which he pioneered over the last 20 years.

Recognising the growing challenge of sameness in architectural hardware, Lovegrove sought to redefine the landscape of door handles and door accessories by exploring the limitless possibilities offered by advanced manufacturing processes.

This collaboration is set to push the boundaries of design and craftsmanship, delivering a collection that epitomises elegance, sophistication, and technological brilliance.

This collection stands out as a perfect representation of our brand's commitment to innovation, sustainability, and contemporary design philosophies.

The use of 3D-printing technology is a significant highlight, as it not only allows for the creation of intricate and unique designs but also embodies a sustainable approach to manufacturing.

This method significantly reduces material waste, aligning with our dedication to environmental responsibility.

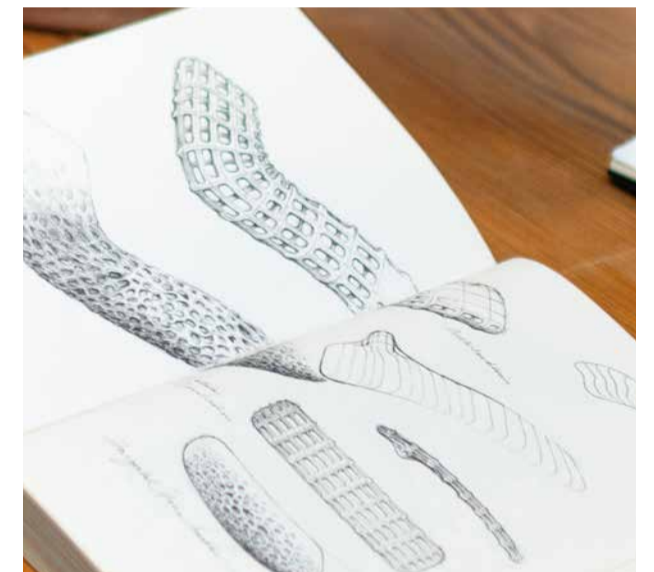

AEROFLOW COLLECTION

BY ROSS LOVEGROVE

ESSENTIAL

Inspired by the skeletal efficiency of avian evolution, this design seeks an extraordinary lightness.

Drawing from the natural engineering of bird bone structures, it reinterprets minimal material use into a seamlessly 3D-printed metal form.

The result is a topology - optimised masterpiece - dematerialised yet structurally resilient.

This design exemplifies the future of lightweight, high-performance architectural elements, merging cutting-edge technology with nature's most efficient designs.

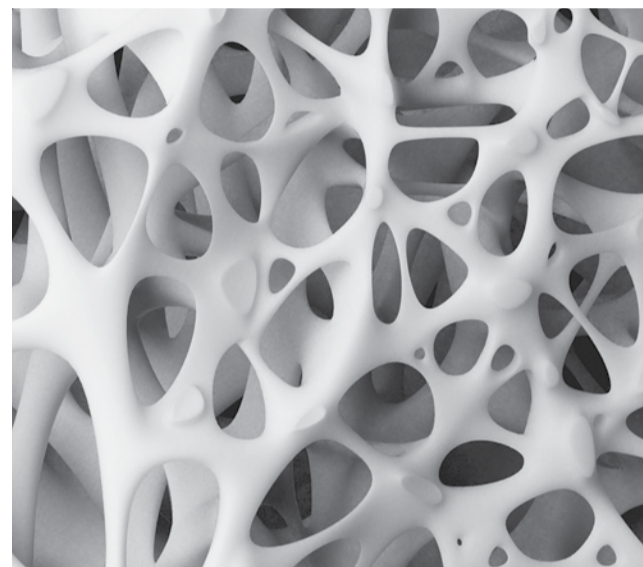

074



“My objective with AEROFLOW was to create a truly minimalist structure unlike anything in the industry.”

Inspired by bird skeletons and the natural forces of intelligent material reduction, it stands as the antithesis of solid mass.

This design embraces negative space, dematerialization, and the interplay of light and shadow on organic metal structures.

It embodies the forefront of my work as a designer, aligning closely with my core philosophy.

Each piece in the **AEROFLOW** Collection possesses its own distinctiveness, transforming the daily act of opening a door or drawer into a harmonious experience, seamlessly integrating into your personal culture.



075





ARCHITECTURAL
HARDWARE

Lovegroove

ARCHITECTURAL COLLECTION

BY ROSS LOVEGROVE

TIMELESS

This design captures the intricate possibilities of additive manufacturing, weaving them into a refined architectural language.

It offers a unique tactile experience, distinct from any other door handle, while maintaining a disciplined aesthetic that appeals to both large and small architectural projects.

The handle embodies an elegant fusion of cultural depth and material precision, making it a timeless addition to spaces where long-term significance and thoughtful design are paramount.

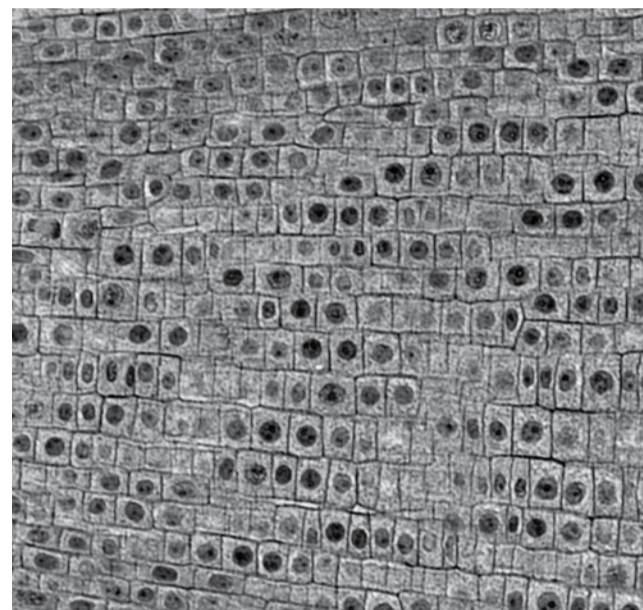

078



“ARCHITECTURAL celebrates the beauty born from organized structural complexity. It pushes production boundaries, achieving a four dimensional impact that defies conventional processes, making it truly contemporary.”

Inspired by a desire to liberate the solid and infuse it with a sense of structural lightness, ARCHITECTURAL finds beauty in repetition.

This collection merges industrial complexity with selective material integrity, creating designs that are both visually striking and physically tactile.



079





ARCHITECTURAL
HARDWARE

Lovegrove

CORAL SYNTH COLLECTION

BY ROSS LOVEGROVE

ORGANIC

Inspired by the organic elegance of coral growth, this handle exudes a luxurious presence grounded in nature's beauty.

The design's luxurious essence, derived from the Latin word *Luxus* (meaning blossoming), evokes the feeling of something growing naturally from the door.

Its form is generous to the touch and reflects light like a finely crafted jewel.

This piece complements the emerging trend of refined craftsmanship in high-end spaces, where beauty and functionality meet in perfect harmony.

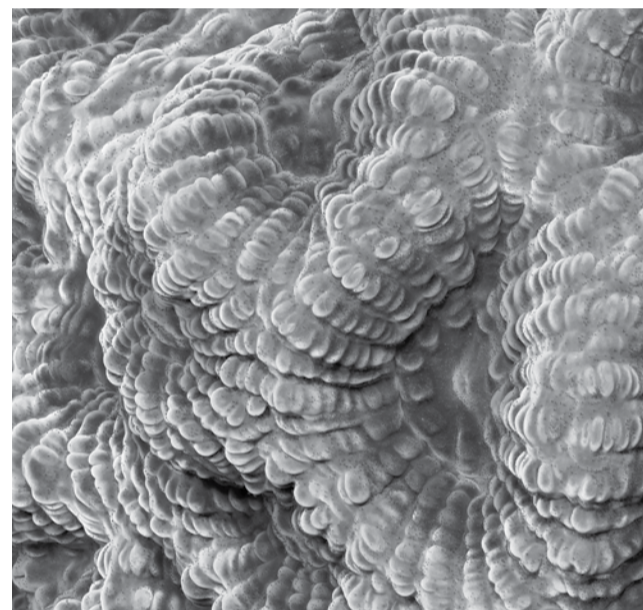

"The CORAL SYNTH Collection transforms hardware into jewelry, elevating it from pure functionality into the realm of object art."

These tactile, generous forms bring a new level of attention to detail, interacting harmoniously with the materials around them and enhancing the value of one's home.

Inspired by coral growth, each piece is voluminous and reflective, capturing light in a way that radiates natural beauty.

Designed to lift the spirit of the user from consumer to collector, **CORAL SYNTH** invites you to own and appreciate beauty in every corner and dimension of your space.







Casa da (EN)COSTA - Guimarães, Portugal
By: Hous3
Photography: © Ivo Tavares Studio

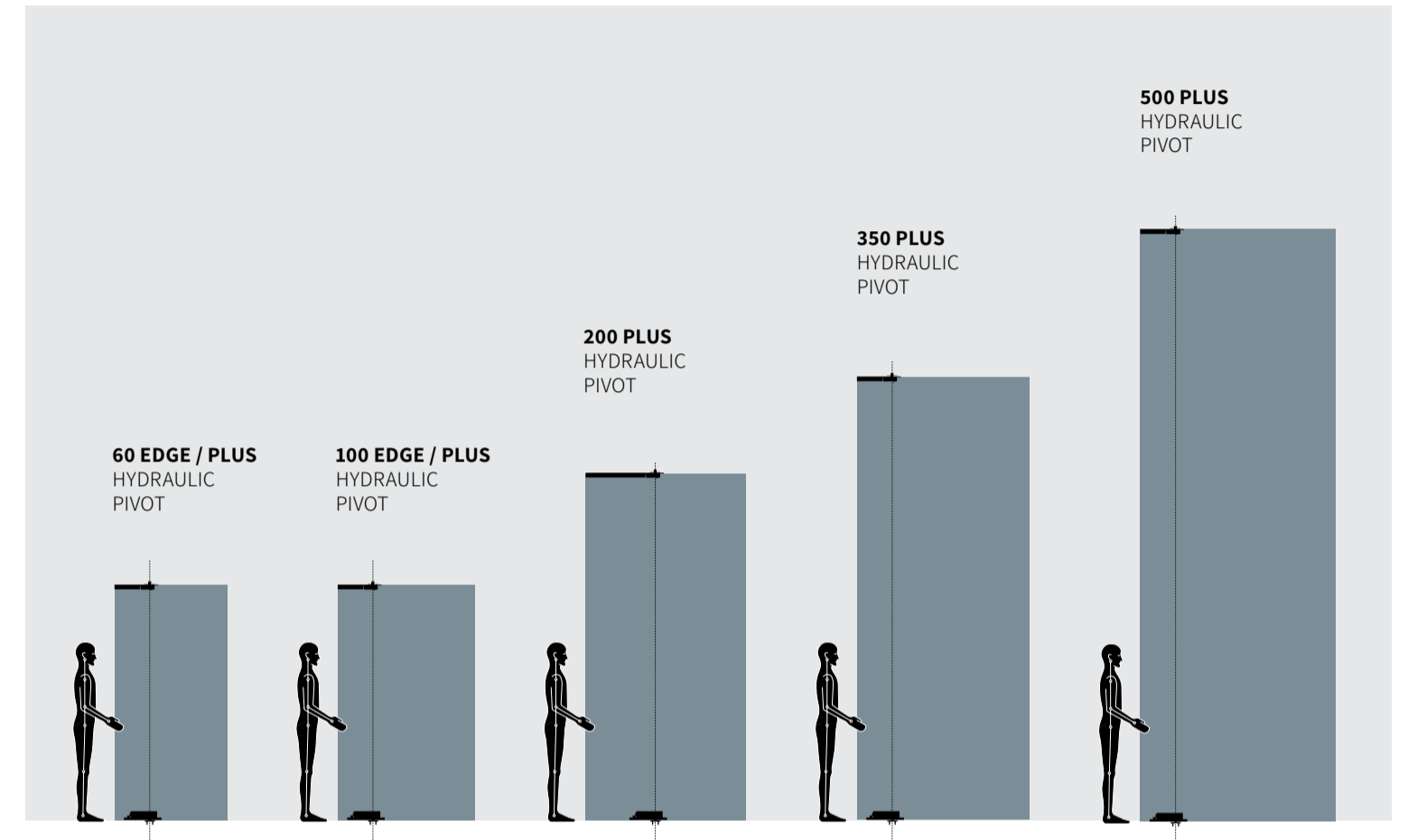

HYDRAULIC PIVOTS

FROM 10KG UP TO 500KG

The CAM system combined with hydraulics allows the closing control of large swing doors, while opening them with little effort. The doors can be single or double action, with minimum thickness 35mm.

The system is hidden inside the door, with only a small base on the floor, with bidirectional regulation and a rotation point on the roof or upper frame of the door with built-in bearing.

The closing control is carried out by two valves that can precisely adjust the initial and final closing speed, the final speed being especially

important when the door has a lock installed.

In order to cover doors with weights from 10 to 500kg, lengths up to 3000mm and height up to 8000mm the system has force adjustment, which can be done with the door already installed.

One of the characteristics of this system is that the rotation point of the door can be from 50mm to the center of the door, with the installation being made from the top of the door, which allows the doors to go up to the ceiling.

HYDRAULIC PIVOTS

FROM 10KG TO 500KG



IN.05.203.HO EDGE
HYDRAULIC PIVOT



IN.05.211.HO PLUS
HYDRAULIC PIVOT



IN.05.204 EDGE
HYDRAULIC PIVOT



IN.05.213.HO PLUS
HYDRAULIC PIVOT



IN.05.212.HO PLUS
HYDRAULIC PIVOT



IN.05.215.HO PLUS
HYDRAULIC PIVOT



IN.05.216.HO PLUS
HYDRAULIC PIVOT



HYDRAULIC SYSTEM



SWIVEL 360°

HYDRAULIC PIVOT

The CAM SYSTEM combined with hydraulics allows the closing control of large swing doors, while opening them with little effort. The doors can be single or double action, with minimum thickness 50mm.

The system is hidden inside the door, with only a small base on the floor, with bidirectional regulation and a rotation point on the roof or upper frame of the door with built-in bearing. The closing control is carried out by one valve. In order to cover doors with weights from 40 to 200kg, lengths up to 3000mm.

One of the characteristics of this system is that the rotation point of the door can be from 40mm to the center of the door, with the installation being made from the top of the door, which allows the doors to go up to the ceiling.



HEAVY DUTY FREE PIVOTS

HIGH-PERFORMANCE PIVOT DOOR SYSTEM

Designed to deliver maximum efficiency, the pivot door system combines high load capacity with exceptional performance. Its advanced engineering ensures smooth and seamless opening and closing, providing a refined and quiet user experience.

With precise adjustment features, it allows for fine-tuning during installation to ensure perfect alignment and highly accurate results. Ideal for projects demanding quality, durability, and sophisticated aesthetics.

IN.05.500

Heavy duty free pivot for timber or metallic doors up to 500kg. Possible to adjust in 3 axes even with door already installed.

This model is concealed on the floor. All the adjustment mechanisms are located on the floor.

IN.05.501

Heavy duty free pivot for timber or metallic doors up to 500kg. Designed to be installed without opening hole on the floor.

Just with two screws we can guarantee 500kg door. The upper mechanism provides simple installation and adjustment.

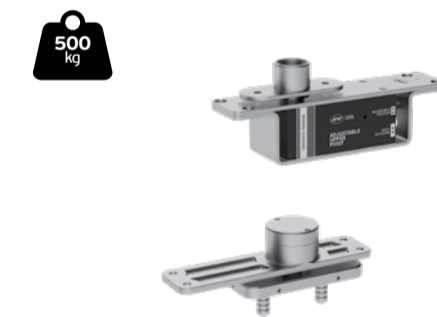
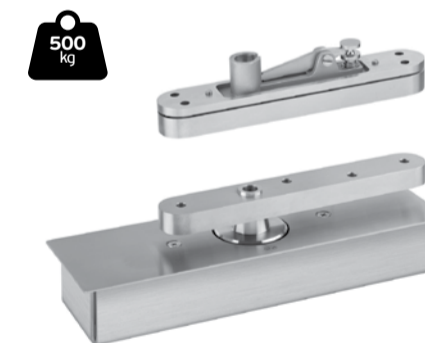

HYDRAULIC PATCH FITTINGS FOR GLASS DOORS

This versatile series of hydraulic pivots for glass doors is designed to adapt to almost any installation scenario. The innovative cam system, combined with hydraulic technology and robust springs, ensures effortless door opening while delivering precise and controlled closing, even in outdoor applications.

Crafted with stainless steel covers and available in premium PVD titanium finishes, these pivots seamlessly complement any type of decor, offering both durability and style for modern architectural designs.



IN.81.203
HYDRAULIC PIVOT SET FOR GLASS DOORS



IN.81.206
HYDRAULIC PIVOT SET FOR GLASS DOORS



IN.81.201
HYDRAULIC PIVOT SET FOR GLASS DOORS



MORE INFORMATION

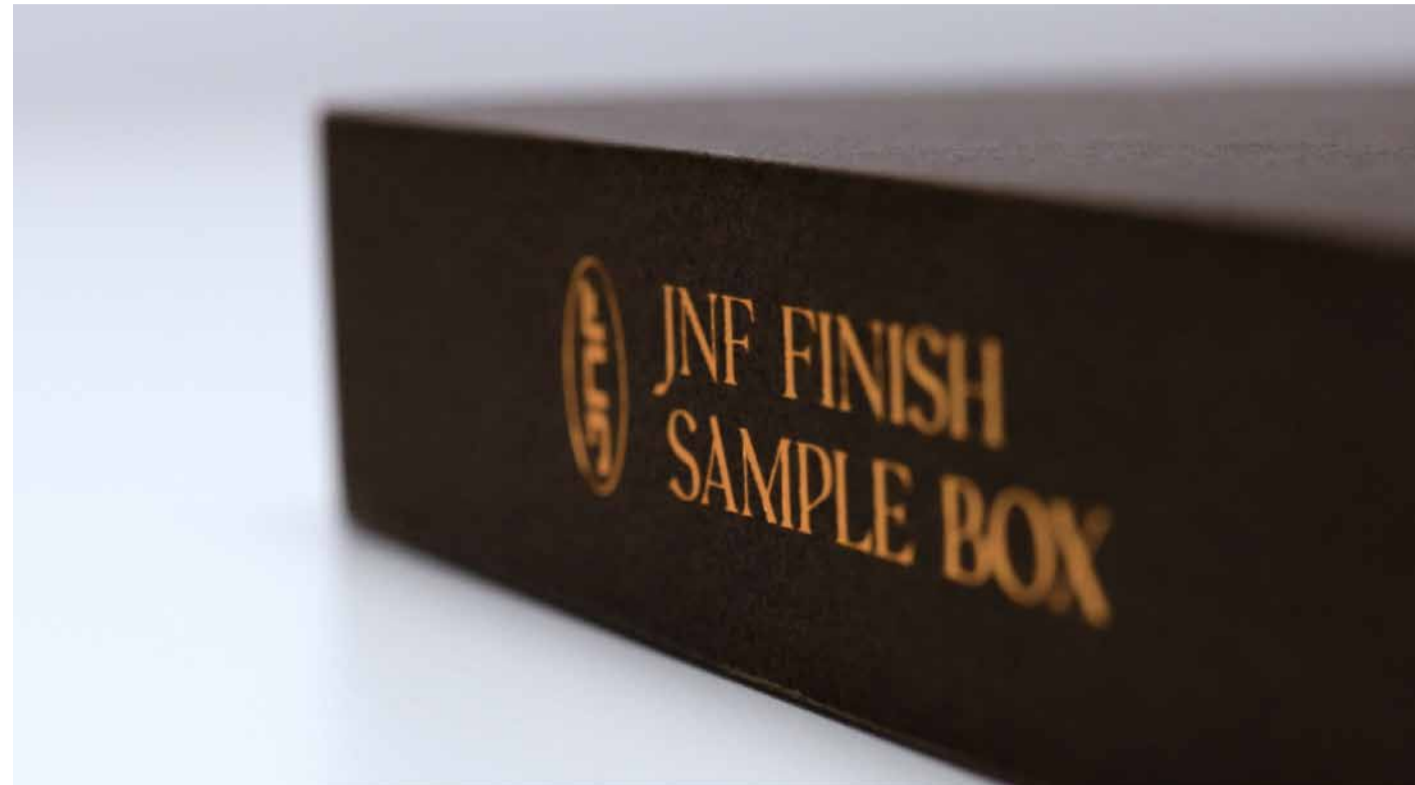

PVD TITANIUM FINISH ON ALL JNF PRODUCTS

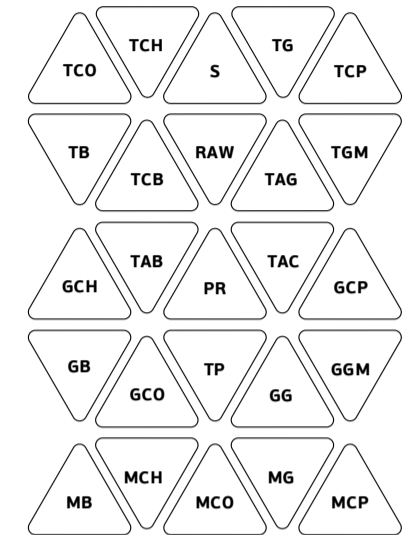

- .S Satin
- .TB Titanium Black
- .TG Titanium Gold
- .TCO Titanium Copper
- .TCH Titanium Chocolate
- .TCP Titanium Champagne
- .TGM Titanium Gun Metal
- .RAW Industrial Raw
- .TCB Titanium Coal Black
- .TAG Titanium Aged Gold
- .TAC Titanium Aged Copper
- .TAB Titanium Aged Bronze
- .PR Pure Grain
- .GB Grain Black
- .GG Grain Gold
- .GCO Grain Copper
- .GCH Grain Chocolate
- .GCP Grain Champagne
- .GGM Grain Gun Metal
- .TP Mirror Polished Titanium
- .MB Mirror Black
- .MG Mirror Gold
- .MCO Mirror Copper
- .MCH Mirror Chocolate
- .MCP Mirror Champagne

096



097

<p>STANDARD FINISH SATIN OR BRUSHED .S</p> <p>This one is our standard finish available in all our hardware. The surface is polished with special brush material to achieve a discrete matte finish with a brushed effect. It's a very discrete finish that gives our fittings a faint reflect about the surrounding colors.</p>	<p>MECHANICAL FINISHES INDUSTRIAL .RAW</p> <p>This finish is achieved at the final phase of the polishing process. The parts are submitted to an abrasion treatment. The end result is absolutely dull pieces with a very nice texture to be touched. Visually, the pieces have a grey concrete like color, giving the pieces an industrial look, like if they were tools. All our products are available with this finish, however there is a limit on the maximum length of 600mm.</p>	<p>MECHANICAL FINISHES PURE GRAIN .PR</p> <p>This finish is achieved in the final phase of the polishing process. The product has a very smooth matte grain texture effect, developing the shape of the design with discrete shadows.</p>	<p>MECHANICAL FINISHES MIRROR POLISHED TITANIUM .TP</p> <p>As the name already suggests, the surface is so shining that can reflect the surrounding as one mirror. This finish is achieved with a very careful process and the result is very bright pieces with a lot of light.</p>
<p>SPECIAL FINISH PVD TITANIUM COATED .TB / .TG / .TCO / .TCH / .TCP / .TGM</p> <p>This is one exceptional high quality finish made exclusively by physical technology. Several metallic colors can be achieved with high resistance to abrasion and corrosion. This non pollution technology is widely used in the watchmaking industry. Some colors performed at JNF: Natural Titanium, Gold, Bronze, Copper, Champagne, Deep Black, Gun Metal, Dark Chocolate.</p>	<p>SPECIAL FINISH PVD TITANIUM AGED .TCB / .TAG / .TAC / .TAB</p> <p>A very matte and textured finish is achieved with this process. Our range of colors such as Aged Gold, Coal Black, Aged Copper and Aged Bronze can provide an antique touch to the decoration.</p>	<p>SPECIAL FINISH PVD TITANIUM GRAIN .GB / .GG / .GCO / .GCH / .GCP / .GGM</p> <p>It is a smooth matte titanium finish with a grain texture and very discrete shadows in metallic colors such as Gold, Champagne, Black, Gun Metal, Copper and Chocolate.</p>	

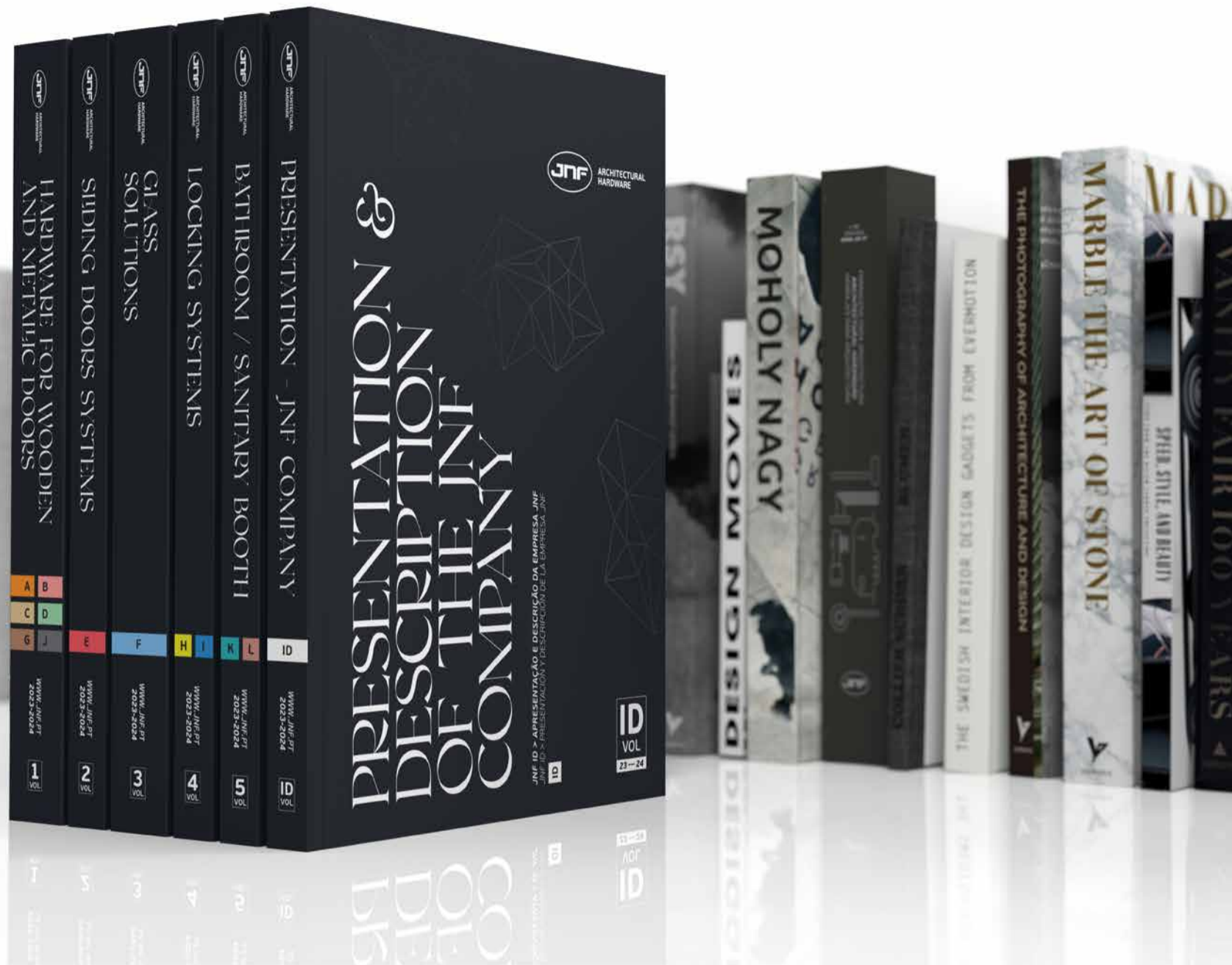

JNF ID > APRESENTAÇÃO E DESCRIÇÃO DA EMPRESA
JNF ID > PRESENTATION AND DESCRIPTION OF THE COMPANY

- A** EMPRESA / THE COMPANY
- M**ATERIAL E ACABAMENTOS / MATERIAL AND FINISHES
- C**ERTIFICAÇÕES / CERTIFICATIONS
- D**EPARTAMENTO I&D / I&D DEPARTMENT
- P**RODUÇÃO / PRODUCTION



SOLUÇÕES PARA VIDRO
GLASS SOLUTIONS

- S**OLUÇÕES PARA PORTAS DE VIDRO PIVOTANTES OU COM DOBRADIÇAS / GLASS DOORS SOLUTIONS FOR PIVOTING OR HINGE SYSTEMS
- S**OLUÇÕES PARA PORTAS DE CORRER EM VIDRO / SLIDING GLASS DOOR SOLUTIONS
- S**OLUÇÕES DE FERRAGENS PARA CABINES DE VIDRO / GLASS HARDWARE SOLUTIONS FOR CABINS
- S**OLUÇÕES DE FERRAGENS PARA PORTAS DE FOLE E PARQUE / HARDWARE SOLUTIONS FOR FOLDING AND PARK GLASS DOORS
- S**OLUÇÕES DE FERRAGENS PARA FIXAÇÃO DE VIDROS / HARDWARE SOLUTIONS FOR FIXING GLASS
- S**OLUÇÕES GERAIS DE FERRAGENS PARA VIDRO / GENERAL HARDWARE GLASS SOLUTIONS



FERRAGENS PARA PORTAS DE MADEIRA E METÁLICAS
HARDWARE FOR WOODEN AND METALLIC DOORS

- A** PUXADORES DE PORTA E ACESSÓRIOS / DOOR LEVER HANDLES AND ACCESSORIES
- B** ASAS DE PORTA E ACESSÓRIOS / PULL HANDLES AND ACCESSORIES
- C** DOBRADIÇAS E PIVOTS / HINGES AND PIVOTS
- D** FERRAGENS DIVERSAS / GENERAL HARDWARE
- F**ERRAGENS PARA MOBILIÁRIO / FURNITURE HARDWARE
- S**INALÉTICA / SIGNAGE



SISTEMAS DE FECHO E CONTROLOS DE ACESSOS
LOCKING SYSTEMS AND ACCESS CONTROL SYSTEMS

- F**ECHADURAS E CILINDROS / LOCKS AND CYLINDERS
- D**ISPOSITIVOS ELECTROMAGNÉTICOS / ELECTROMAGNETIC DEVICES
- B**ARRAS ANTI-PÂNICO / ANTI-PANIC BARS
- M**OLAS DE PORTA E VEDANTES / DOOR CLOSERS AND DROP SEALS
- S**ISTEMAS DE CONTROLO DE ACESSOS / ACCESS CONTROL SYSTEMS
- L**EITORES DE PAREDE / WALL READERS
- T**ECLADOS NUMÉRICOS / NUMERIC KEYPAD



VOYAGER
ACCESS CONTROL SOLUTIONS BY JNF

- V**OYAGER / VOYAGER
- V**OYAGER CORPORATE / VOYAGER CORPORATE
- A**CCESS CONTROL SOLUTIONS / SOLUÇÕES DE CONTROLO DE ACESSOS
- S**90 S-TRONIC CYLINDER / CILINDRO S90 S-TRONIC
- W**ALL CONTROL SOLUTIONS / SOLUÇÕES DE CONTROLO DE ACESSOS DE PAREDE
- G**ATEWAY SOLUTIONS / SOLUÇÕES DE GATEWAYS



ORGANIC ESSENTIALS
BY ROSS LOVEGROVE

- B**EHIND THE COLLECTION / POR DETRÁS DA COLEÇÃO
- A**EROFLOW COLLECTION / COLEÇÃO AEROFLOW
- A**RCHITECTURAL COLLECTION / COLEÇÃO ARCHITECTURAL
- C**ORAL SYNTH COLLECTION / COLEÇÃO CORAL SYNTH



SISTEMAS PARA PORTAS DE CORRER
SLIDING DOOR SYSTEMS

- S**ISTEMA PARA PORTAS DE CORRER AUTOMÁTICAS / AUTOMATIC SLIDING DOOR SYSTEM
- P**ORTAS DE CORRER COM CARRIL EM ALUMÍNIO / MANUAL DOORS WITH ALUMINIUM TRACK
- S**ISTEMA PARA PORTAS DE CORRER OCULTO / OFFSCREEN SLIDING DOOR SYSTEM
- P**ORTAS MANUAIS EM AÇO INOX / STAINLESS STEEL MANUAL DOORS
- S**ISTEMA PARA PORTAS DE CORRER DE PAVIMENTO / SLIDING DOOR SYSTEMS ON THE FLOOR
- S**ISTEMA PARA PORTAS DE CORRER DE LIVRO / FOLDING DOOR SYSTEMS



WC AND SOLUÇÕES PARA CABINES SANITÁRIAS
BATHROOM ACCESSORIES AND SANITARY BOOTH HARDWARE

- A**CESSÓRIOS PARA CASA DE BANHO / BATHROOM ACCESSORIES
- C**LEANING SYSTEMS / CLEANING SYSTEMS
- A**UXÍLIOS TÉCNICOS PARA PESSOAS COM MOBILIDADE REDUZIDA / TECHNICAL AID FOR PEOPLE WITH CONDITIONED MOBILITY
- S**ISTEMAS MODULARES PARA CABINES SANITÁRIAS / SANITARY BOOTH HARDWARE



JNF PORTUGAL
Head office / Factory

Comércio e Indústria de Ferragens S.A.
Rua Mimosas 849/851,
Zona Industrial Mimosas
S. Pedro da Cova | Apartado 75
4424-909 Gondomar, Portugal

Tel: +351 224 663 230
jnf@jnf.pt
www.jnfhardware.com

JNF SPAIN
Office / Showroom

JNFmyStore
Carrer Bruc, 77 Local dch.
08009 Barcelona

Tel: +34 932 504 047
Fax: +34 934 674 500
jnf@jnfmystore.es
www.jnfmystore.es

The technical specifications of the products contained in this catalog may be changed without prior notice. All dimensions in this catalog are in millimeters.

Full or partial copying of this catalog is not permitted.

CT.25.01.0.EN